

AC/DC Converter

Isolation Fly-back Converter PWM method Output 22.5W 15V

BM2P016T Reference Board

BM2P016T-EVK-002

The BM2P016T-EVK-002 evaluation board outputs 15V voltage from the input of 90Vac to 264Vac. The output current supplies up to 1.5A. BM2P016T which is PWM method DC/DC converter IC built-in 650V MOSFET is used.

The BM2P016T contributes to low power consumption by built-in a 650 V starting circuit.

Current mode control imposes current limitation on every cycle, providing superior performance in bandwidth and transient response. The switching frequency is 65 kHz in fixed mode. At light load, frequency is reduced and high efficiency is realized. Built-in frequency hopping function contributes to low EMI. Low on-resistance 1.4 Ω 650 V MOSFET built-in contributes to low power consumption and easy design.

The flywheel diode is a fast recovery diode of 6A/600 V RF601TDNZ, contributing to low power consumption.

The conduction / radiation emission test is based on CISPR 22 Class B with best EMI design.

Electronics Characteristics

Not guarantee the characteristics, is representative value. Unless otherwise noted : $V_{IN} = 230\text{Vac}$, $I_{OUT} = 1500\text{mA}$, $T_a:25^\circ\text{C}$

Parameter	Min	Typ	Max	Units	Conditions
Input Voltage Range	90	230	264	Vac	
Input Frequency	47	50/60	63	Hz	
Output Voltage	13.5	15.0	16.5	V	
Maximum Output Power	-	15.0	22.5	W	$I_{OUT} = 1500\text{mA}$
Output Current Range (NOTE1)	0	1000	1500	mA	
Stand-by Power	-	130	-	mW	$I_{OUT} = 0\text{A}$
Efficiency	-	84.5	-	%	
Output Ripple Voltage (NOTE2)	-	200	-	mVpp	
Operating Temperature Range	-10	25	65	$^\circ\text{C}$	

(NOTE1) Please adjust operating time, within any parts surface temperature under 105 $^\circ\text{C}$

(NOTE2) Not include spike noise

Operation Procedure

1. Operation Equipment

- (1) AC Power supply 90Vac~264Vac, over 10W
- (2) Electronic Load capacity 1.5A
- (3) Multi meter

2. Connect method

- (1) AC power supply presetting range 90~264Vac, Output switch is off.
- (2) Load setting under 1.5A. Load switch is off.
- (3) AC power supply N terminal connect to the board AC (N) of CN1, and L terminal connect to AC (L).
- (4) Load + terminal connect to VOUT, GND terminal connect to GND terminal
- (5) AC power meter connect between AC power supply and board.
- (6) Output test equipment connects to output terminal
- (7) AC power supply switch ON.
- (8) Check that output voltage is 15V.
- (9) Electronic load switch ON
- (10) Check output voltage drop by load connect wire resistance

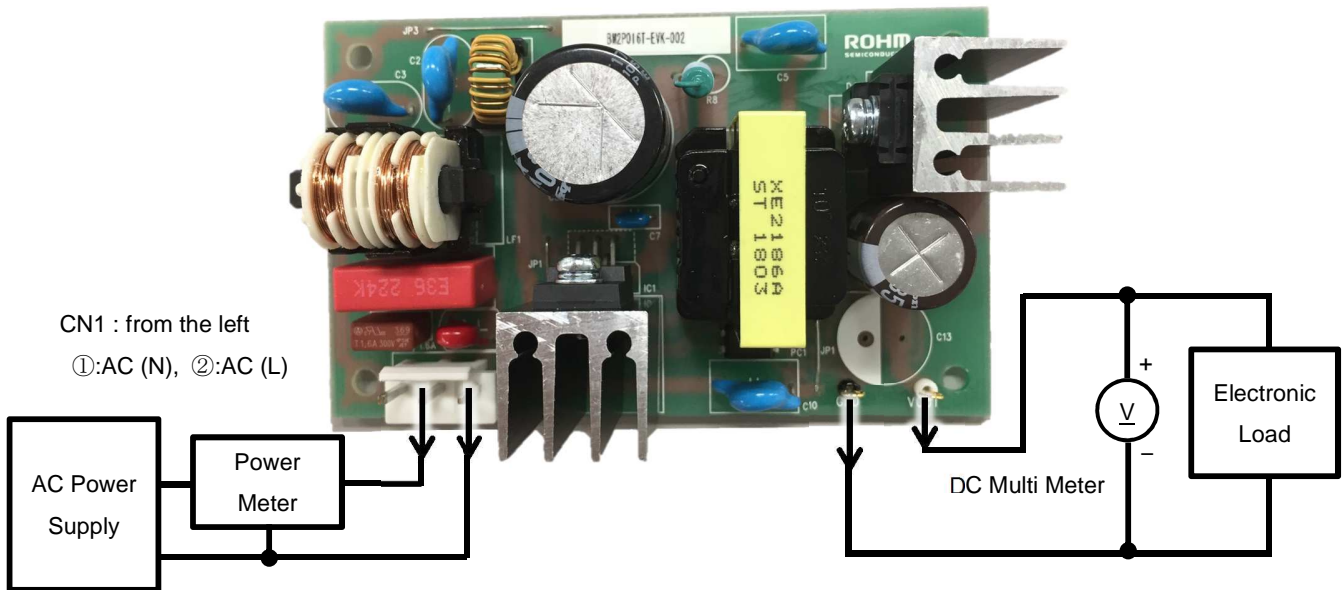

Figure 1. Connection Circuit

Deleting

Maximum Output Power P_o of this reference board is 22.5W. The derating curve is shown on the right.

Please adjust load continuous time by over 105°C of any parts surface temperature within the operating temperature range (-10~65°C).

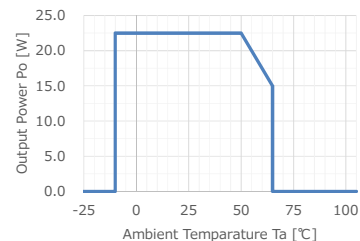

Figure 2. Temperature Deleting curve

Schematics

V_{IN} = 90~264Vac, V_{OUT} = 15V

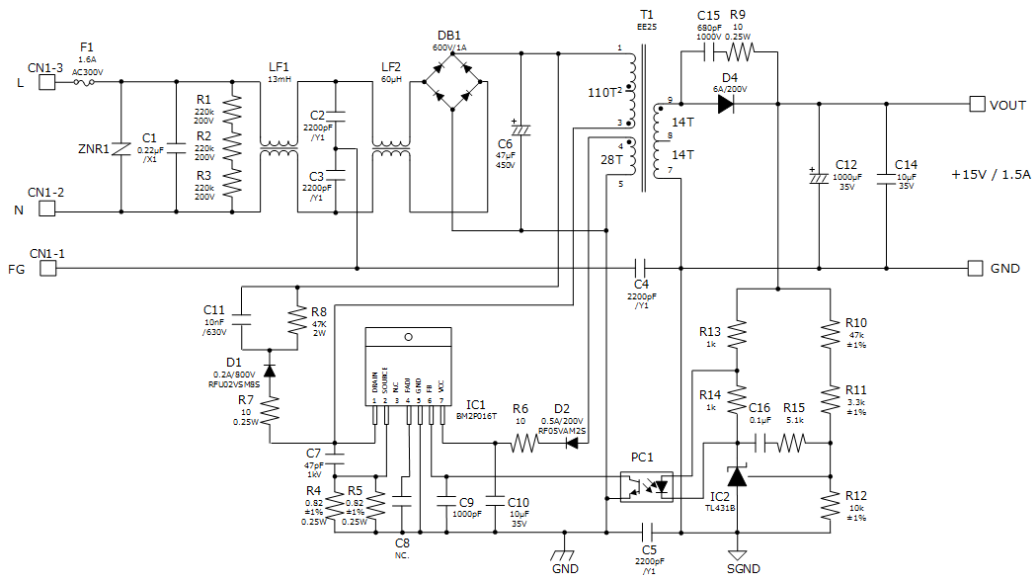

Figure 3. BM2P016T-EVK-002 Schematics

Bill of Materials

Table 1. BoM of BM2P016T-EVK-002

Part Reference	Qty.	Type	Value	Description	Part Number	Manufacture	Configuration mm (inch)
C1	1	X2 Capacitor	0.1μF	300Vac, ±20%	890 334 025 027C S	Wurth	-
C2,C3,C4 C5	4	Y1 Capacitor	2200pF	Y1 capacitor	DE1E3KX222MB4BP01F	Murata	-
C6	1	Electrolytic	47μF	450V, ±20%	450BXW47MEFR18x20	Rubycon	18mmΦX20mm
C7	1	Ceramic	47pF	1000V, X7R, ±10%	RDE5C3A470J2K1H03B	Murata	-
C8	0	Ceramic	NC	-	N.C.	Taiyo Yuden	1608 (0603)
C9	1	Ceramic	1000pF	100V, X7R, ±10%	HMK107B7102KA-T	Taiyo Yuden	1608 (0603)
C10,C14	2	Ceramic	10μF	35V, X7R, ±20%	GMK316AB7106ML-TR	Taiyo Yuden	3216 (1206)
C11	1	Ceramic	10nF	630V, X7R, ±10%	GRM31AR72J103KW01	Murata	3216 (1206)
C12	1	Electrolytic	1000uF	35V, ±20%	UPA1V102MPD	Nichicon	12.5mmΦX20mm
C15	1	Ceramic	680pF	1000V, X7R, ±10%	GRM31BR73A681KW01	Murata	3216 (1206)
C16	1	Ceramic	3300pF	100V, X7R, ±10%	HMK107B7332KA-T	Taiyo Yuden	DIP7
CN1	1	Connector	3pin	5mm pitch	B3P-NV	JST	-
DB1	1	Bridge	1A	600V	S1NB60-7062	Shindengen	-
D1	1	FRD	0.2A	800V	RFU02VSM8S	ROHM	TUMD2M
D2	1	FRD	0.5A	200V	RF05VAM2S	ROHM	TUMD2M
D3	1	FRD	6A	200V	RF601T2DNZ	ROHM	TO-220
F1	1	Fuse	1.6A	1.6A 300V	36911600000	Littelfuse	-
HS1,HS2	2	Heat Sink	-	22.9°C/W	IC-1625-STL	Sankyo Thermotec	-
-	2	Skrew	M3	M3	SEMS-SCREW-P4-3X8	TOMOHO	-
IC1	1	AC/DC Converter	-	650V	BM2P016T-Z	ROHM	TO220-7
IC2	1	Shunt Regulator	120kΩ	2W, 700V, ±2%	TL431BIDBZT	TI	SOT-23-3
LF1	1	Line Filter	13mH	1A	XF1482Y	Alpha Trans	-
LF2	1	Line Filter	60μH	1A	LF1246Y	Alpha Trans	-
PC1	1	Optocoupler	-	5kV	LTV-817-B	LiteOn	DIP4
R1,R2,R3	3	Resistor	220kΩ	0.25W, ±5%	MCR18EZPJ224	ROHM	3216 (1206)
R4,R5	2	Resistor	0.82Ω	0.25W, ±1%	MCR18EZHFRLR820	ROHM	3216 (1206)
R6,R7,R9	3	Resistor	10Ω	0.25W, ±5%	MCR18EZPJ100	ROHM	3216 (1206)
R8	1	Resistor	47kΩ	2W, 700V, ±2%	ERG2S1473	Panasonic	-
R10	1	Resistor	47kΩ	0.1W, ±1%	MCR03EZPFX4702	ROHM	1608 (0603)
R11	1	Resistor	3.3kΩ	0.1W, ±1%	MCR03EZPFX3302	ROHM	1608 (0603)
R12	1	Resistor	10kΩ	0.1W, ±1%	MCR03EZPFX1002	ROHM	1608 (0603)
R13,R14	2	Resistor	1kΩ	0.1W, ±5%	MCR03EZPJ102	ROHM	1608 (0603)
R15	1	Resistor	5.1kΩ	0.1W, ±5%	MCR03EZPJ512	ROHM	1608 (0603)
T1	1	Transformer	-	Bobin:EI-2506, Core:EE25/20	XE2186A	Alpha Trans	-
ZNR1	1	Varistor	-	300Vac, 423Vmin, 400A	V470ZA05P	Littelfuse	5mmΦ Disc

PCB

Size : 55 mm x 91 mm

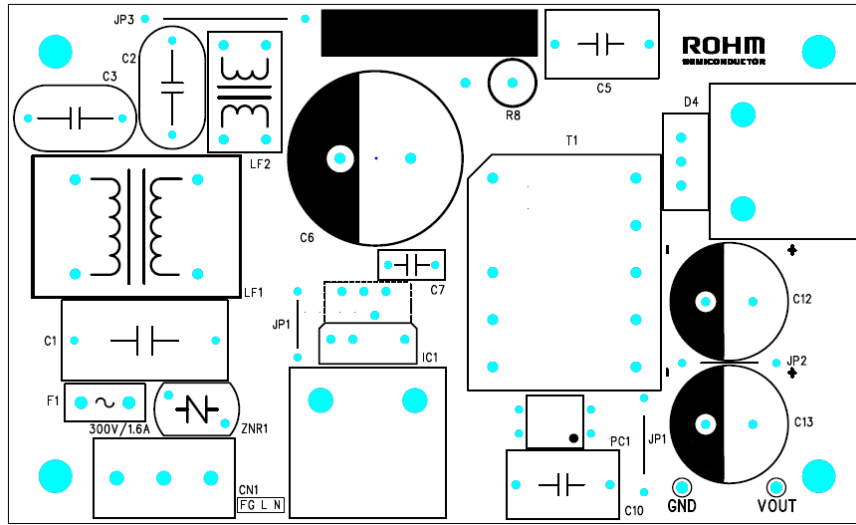

Figure 4. Top Silkscreen (Top view)

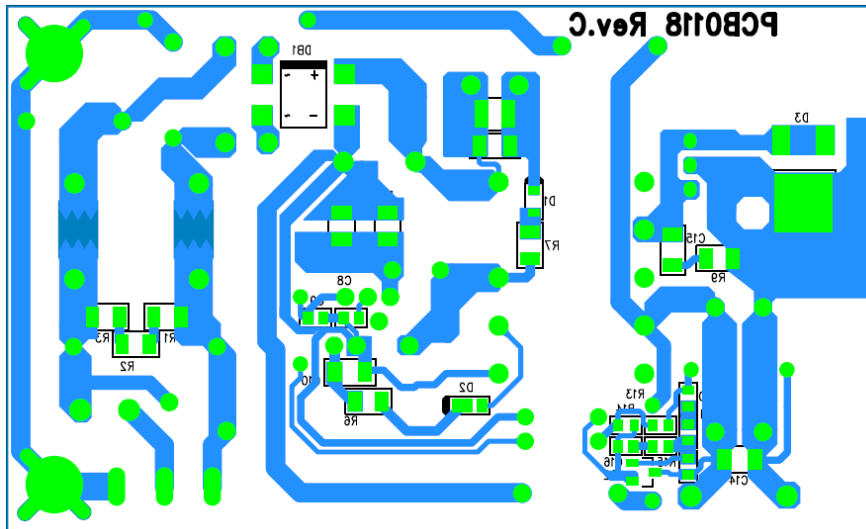

Figure 5. Bottom Layout (Top view)

Transformer Design

Product : XE2186A AlphaTrans Corp.

Bobbin : EI-2506 10PIN

Core : EE25/20 JSF

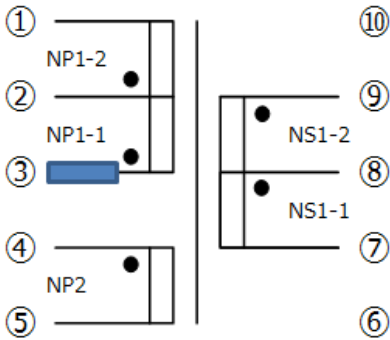

Figure 6. Connection Diagram

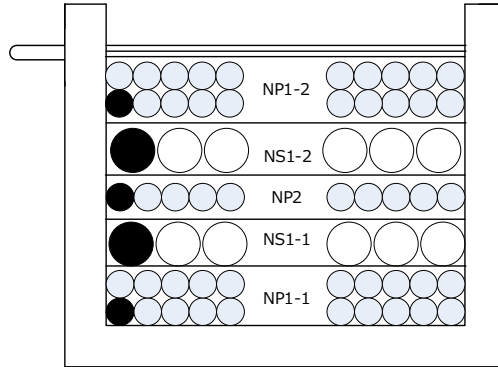

Figure 7. Winding structure diagram

Table 2. Winding Specification

Winding	PIN	Winding Material	Number of Turns		
			Winding*	Barrier Tape	Insulation Tape
NP1-1	③→②	2UEW 0.32	56T / 2Layer		
Insulation Tape					1T
NS1-2	⑨→⑧	TEX-E 0.50	14T		
Insulation Tape					1T
NP2	④→⑤	2UEW 0.32	28T		
Insulation Tape					1T
NS1-1	⑧→⑦	TEX-E 0.50	14T		
Insulation Tape					1T
NP1-2	②→①	2UEW 0.32	54T / 2Layer		
Insulation Tape					3T

*All windings are closely wound

Inductance (Lp)		1000μH±10% (100kHz,1V)
Leakage Inductance		50μH MAX
Withstand Voltage	Pri – Sec	AC1500V
	Sec - Core	AC1500V
	Pri – Core	AC500V
Insulation resistance		100MΩ over (DC500V)

Manufacturer : Alfatrans Co., LTD.

〒541-0059 2-7-1 bakurou-cho, chu-o ku, osaka

<http://www.alphatrans.jp/>

Performance Data

· Constant Load Regulations

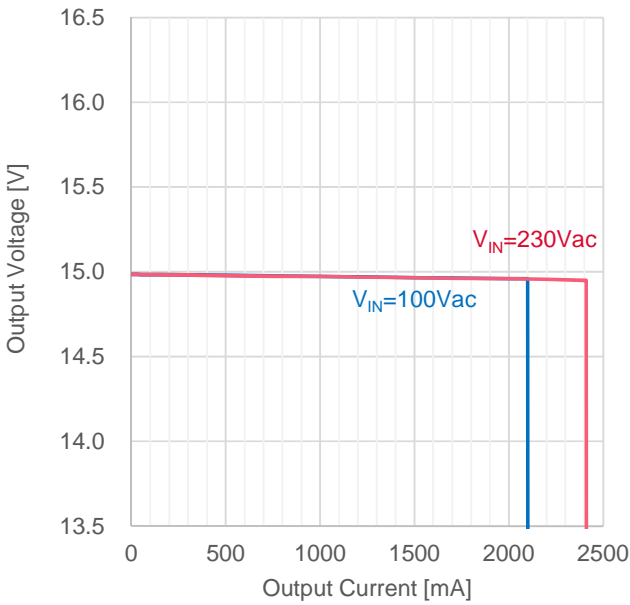

Figure 8. Load Regulation (I_{OUT} vs. V_{OUT})

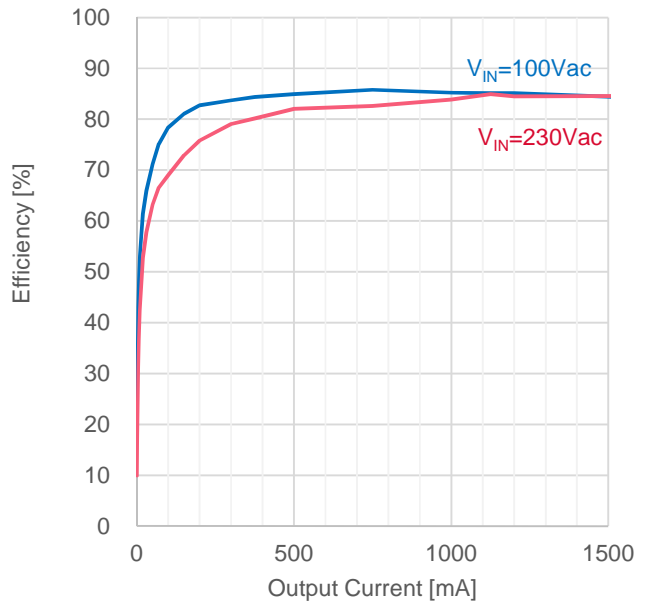

Figure 9. LOAD Regulation (I_{OUT} vs. Efficiency)

Table 3. Load Regulation ($V_{IN}=100Vac$)

I_{OUT}	V_{OUT}	Efficiency
375 mA	14.981 V	84.35 %
750 mA	14.976 V	85.74 %
1125 mA	14.971 V	85.11 %
1500 mA	14.966 V	84.43 %

Table 4. Load Regulation ($V_{IN}=230Vac$)

I_{OUT}	V_{OUT}	Efficiency
375 mA	14.980 V	80.14 %
750 mA	14.975 V	82.58 %
1125 mA	14.971 V	84.93 %
1500 mA	14.965 V	84.52 %

· Power Consumption

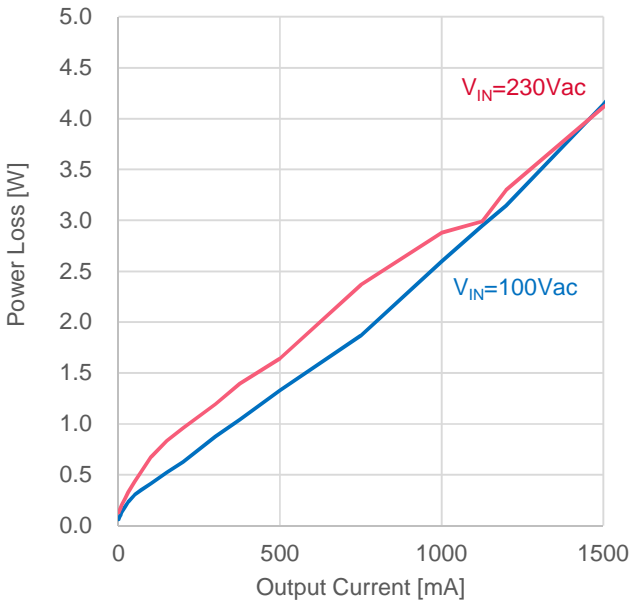

Figure 10. Load Regulation (I_{OUT} vs. P_{LOSS})

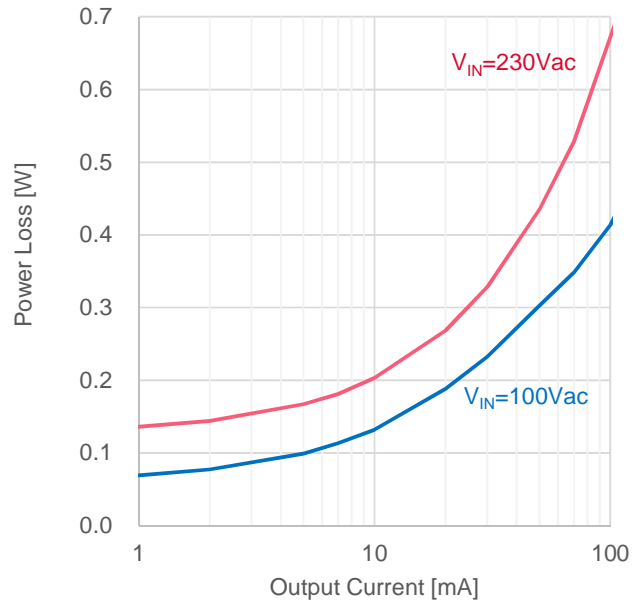

Figure 11. LOAD Regulation (I_{OUT} vs. P_{LOSS})

· Constant AC Line Regulations

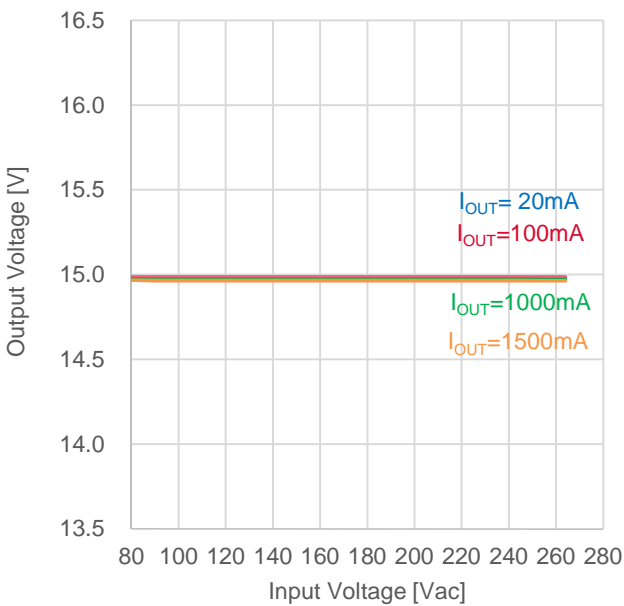

Figure 12. LINE Regulation (I_{OUT} vs. V_{OUT})

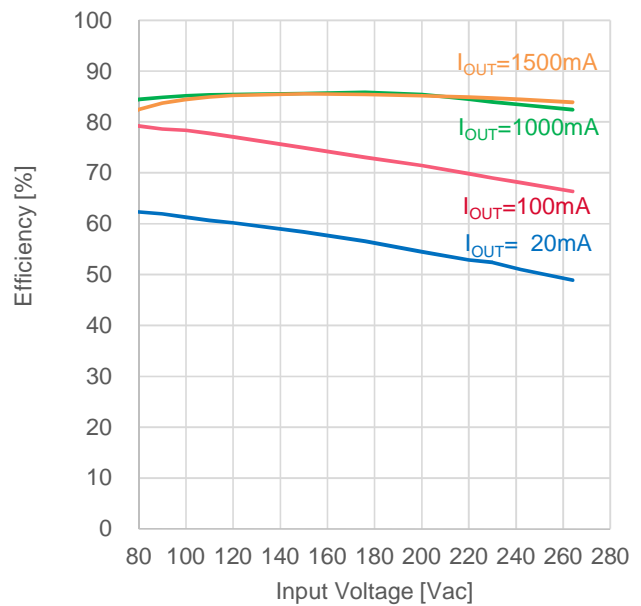

Figure 13. LINE Regulation (I_{OUT} vs. Efficiency)

· Switching Frequency

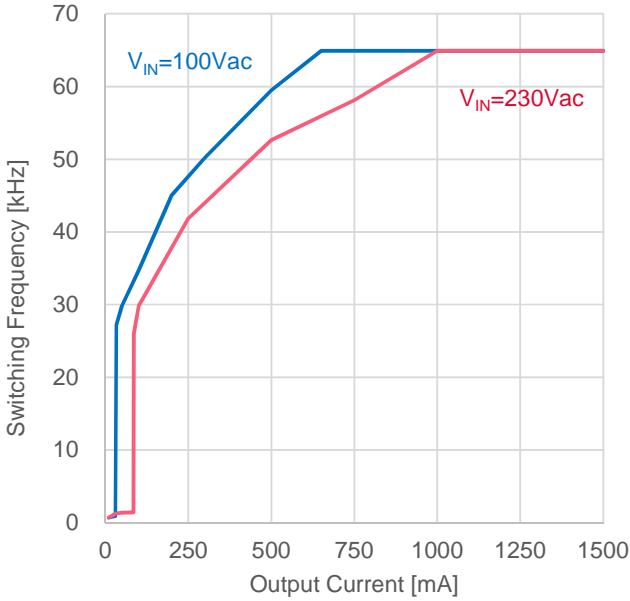

Figure 14. Switching Frequency (I_{OUT} vs. F_{sw})

· Coil Peak Current

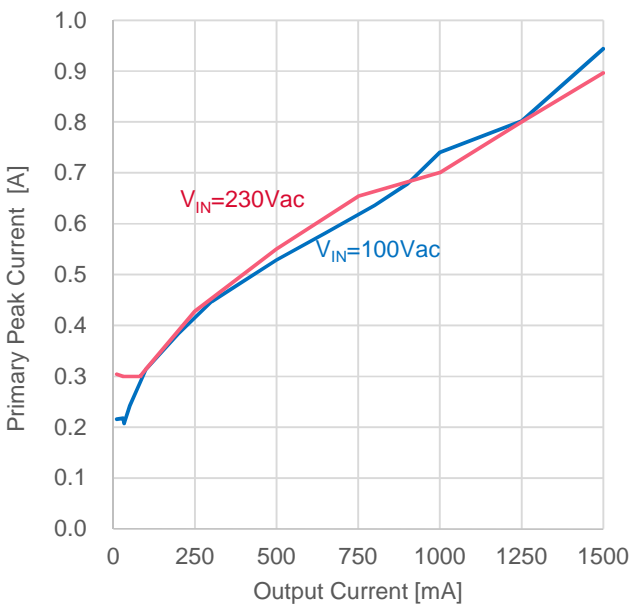

Figure 15. Primary Peak Current (I_{OUT} vs. I_{peak})

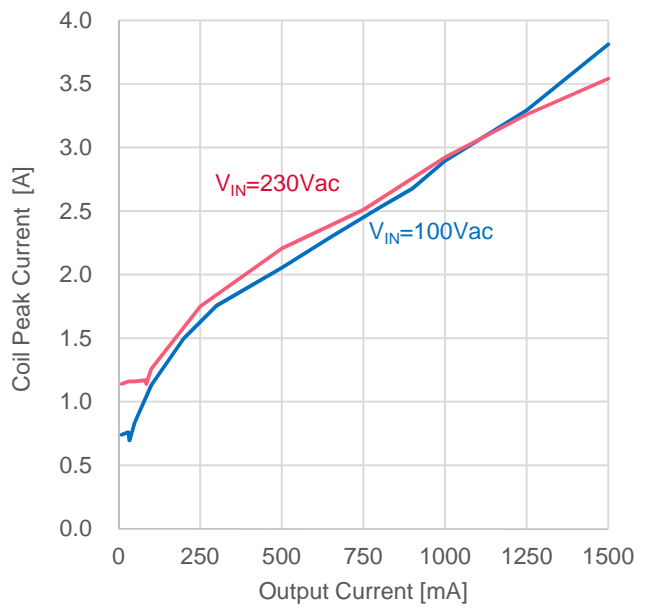

Figure 16. Secondary Peak Current (I_{OUT} vs. I_{peak})

· VOUT Ripple Voltage

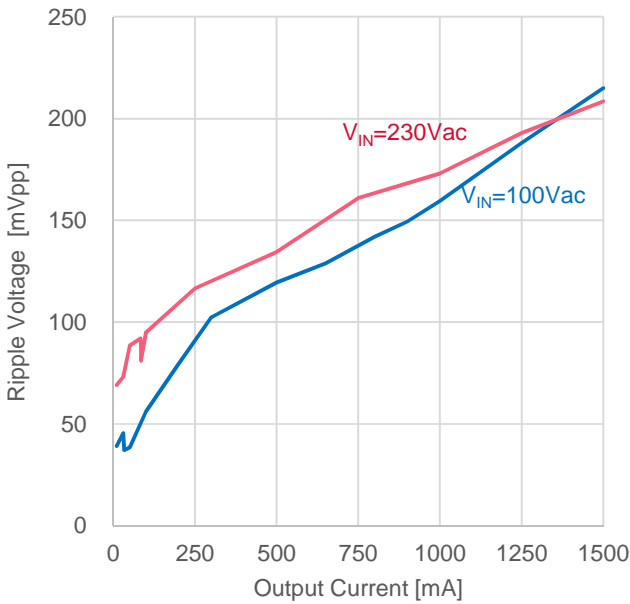

Figure 17. VOUT Ripple Voltage (Iout vs. Vripple)

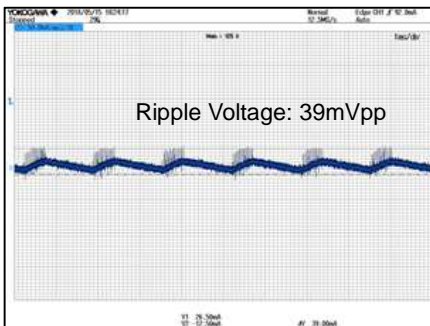

Figure 18. VOUT Ripple Voltage.1
VIN=100Vac, IOUT=10mA
CH1: VOUT 50mV/div, 1000µs/div

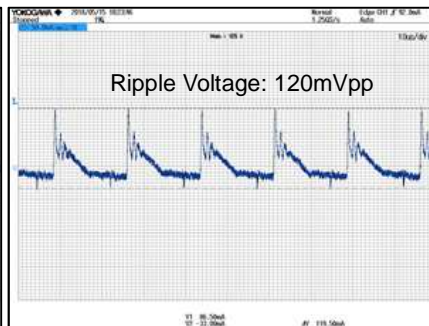

Figure 19. VOUT Ripple Voltage.2
VIN=100Vac, IOUT=500mA
CH1: VOUT 50mV/div, 10µs/div

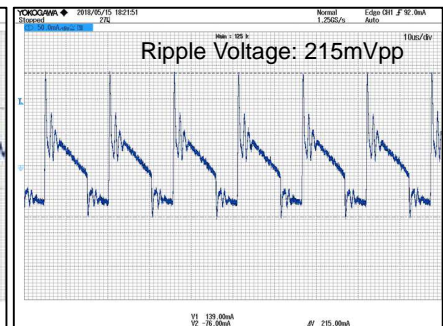

Figure 20. VOUT Ripple Voltage.3
VIN=100Vac, IOUT=1500mA
CH1: VOUT 50mV/div, 10µs/div

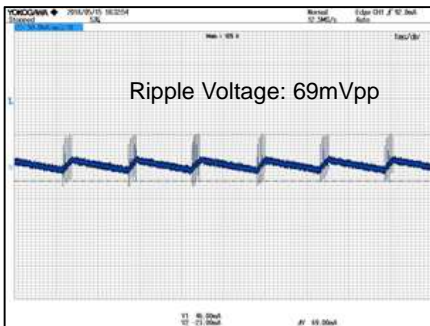

Figure 21. VOUT Ripple Voltage.4
VIN=230Vac, IOUT=10mA
CH1: VOUT 50mV/div, 1000µs/div

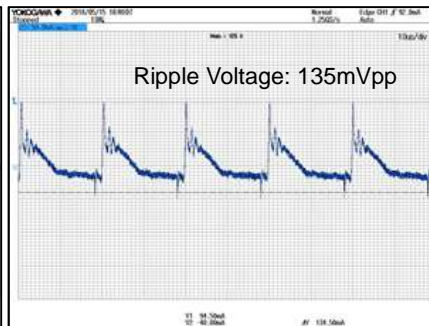

Figure 22. VOUT Ripple Voltage.5
VIN=230Vac, IOUT=500mA
CH1: VOUT 50mV/div, 10µs/div

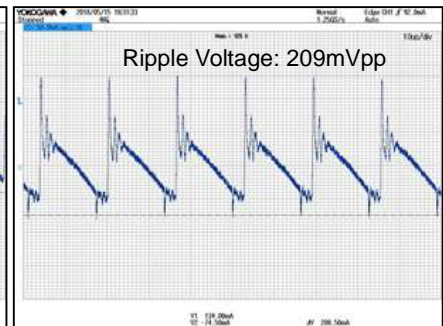

Figure 23. VOUT Ripple Voltage.6
VIN=230Vac, IOUT=1500mA
CH1: VOUT 50mV/div, 10µs/div

· Operating Temperature

The Results were measured 30 minutes after startup.

Table 5. Parts surface temperature (Ta: 25°C)

Part	Condition	
	V _{IN} =90Vac, I _{OUT} =1.5A	V _{IN} =264Vac, I _{OUT} =1.5A
IC1	50.1 °C	56.0 °C
D1	64.9 °C	63.5 °C
DB1	65.0 °C	44.7 °C
T1	80.1 °C	81.2 °C

· EMI

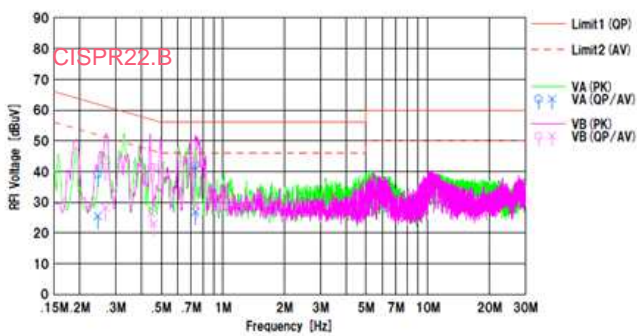

Figure 24. Conducted Emission.1

V_{IN}=110Vac/60Hz, I_{OUT}=1.5A

QP margin= 11.7dB, AV margin=17.1dB

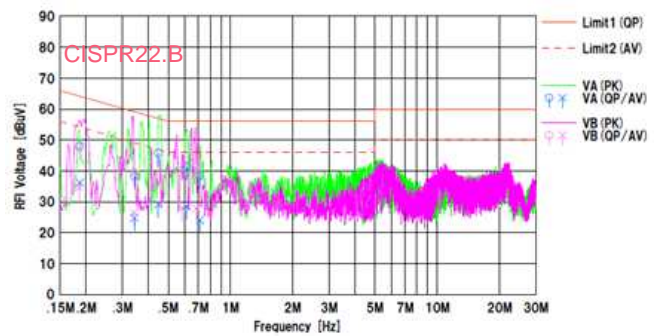

Figure 25. Conducted Emission.2

V_{IN}=230Vac/50Hz, I_{OUT}=1.5A

QP margin= 11.1dB, AV margin=17.3dB

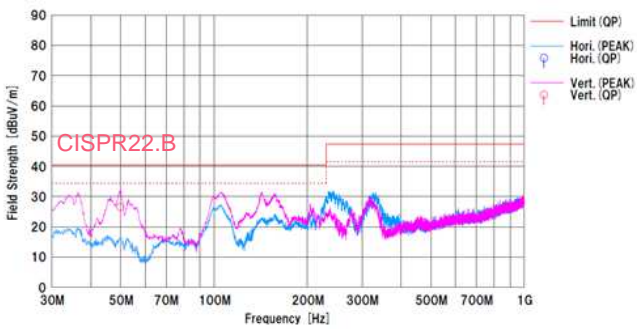

Figure 26. Radiated Emission.1

V_{IN}=110Vac/60Hz, I_{OUT}=1.5A

QP margin=13.9dB, AV margin=21.2dB

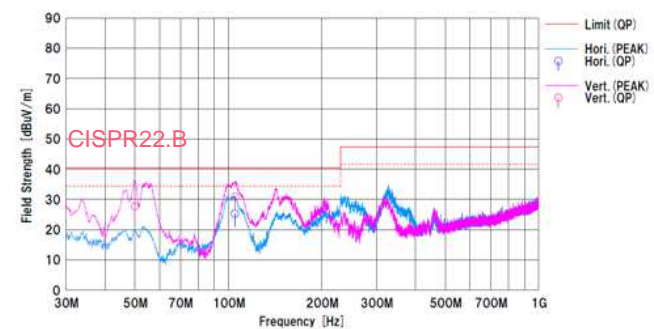

Figure 27. Radiated Emission.2

V_{IN}=230Vac/50Hz, I_{OUT}=1.5A

QP margin= 9.6dB, AV margin=13.4dB

Notes

- 1) The information contained herein is subject to change without notice.
- 2) Before you use our Products, please contact our sales representative and verify the latest specifications :
- 3) Although ROHM is continuously working to improve product reliability and quality, semiconductors can break down and malfunction due to various factors.
Therefore, in order to prevent personal injury or fire arising from failure, please take safety measures such as complying with the derating characteristics, implementing redundant and fire prevention designs, and utilizing backups and fail-safe procedures. ROHM shall have no responsibility for any damages arising out of the use of our Products beyond the rating specified by ROHM.
- 4) Examples of application circuits, circuit constants and any other information contained herein are provided only to illustrate the standard usage and operations of the Products. The peripheral conditions must be taken into account when designing circuits for mass production.
- 5) The technical information specified herein is intended only to show the typical functions of and examples of application circuits for the Products. ROHM does not grant you, explicitly or implicitly, any license to use or exercise intellectual property or other rights held by ROHM or any other parties. ROHM shall have no responsibility whatsoever for any dispute arising out of the use of such technical information.
- 6) The Products specified in this document are not designed to be radiation tolerant.
- 7) For use of our Products in applications requiring a high degree of reliability (as exemplified below), please contact and consult with a ROHM representative : transportation equipment (i.e. cars, ships, trains), primary communication equipment, traffic lights, fire/crime prevention, safety equipment, medical systems, servers, solar cells, and power transmission systems.
- 8) Do not use our Products in applications requiring extremely high reliability, such as aerospace equipment, nuclear power control systems, and submarine repeaters.
- 9) ROHM shall have no responsibility for any damages or injury arising from non-compliance with the recommended usage conditions and specifications contained herein.
- 10) ROHM has used reasonable care to ensure the accuracy of the information contained in this document. However, ROHM does not warrants that such information is error-free, and ROHM shall have no responsibility for any damages arising from any inaccuracy or misprint of such information.
- 11) Please use the Products in accordance with any applicable environmental laws and regulations, such as the RoHS Directive. For more details, including RoHS compatibility, please contact a ROHM sales office. ROHM shall have no responsibility for any damages or losses resulting non-compliance with any applicable laws or regulations.
- 12) When providing our Products and technologies contained in this document to other countries, you must abide by the procedures and provisions stipulated in all applicable export laws and regulations, including without limitation the US Export Administration Regulations and the Foreign Exchange and Foreign Trade Act.
- 13) This document, in part or in whole, may not be reprinted or reproduced without prior consent of ROHM.



Thank you for your accessing to ROHM product informations.
More detail product informations and catalogs are available, please contact us.

ROHM Customer Support System

<http://www.rohm.com/contact/>

■<High Voltage Safety Precautions>

◇ Read all safety precautions before use

Please note that this document covers only the BM2P016T-Z evaluation board (BM2P016T-EVK-002) and its functions. For additional information, please refer to the datasheet.

To ensure safe operation, please carefully read all precautions before handling the evaluation board



Depending on the configuration of the board and voltages used,

Potentially lethal voltages may be generated.

Therefore, please make sure to read and observe all safety precautions described in the red box below.

Before Use

- [1] Verify that the parts/components are not damaged or missing (i.e. due to the drops).
- [2] Check that there are no conductive foreign objects on the board.
- [3] Be careful when performing soldering on the module and/or evaluation board to ensure that solder splash does not occur.
- [4] Check that there is no condensation or water droplets on the circuit board.

During Use

- [5] Be careful to not allow conductive objects to come into contact with the board.
- [6] **Brief accidental contact or even bringing your hand close to the board may result in discharge and lead to severe injury or death.**
Therefore, DO NOT touch the board with your bare hands or bring them too close to the board.
In addition, as mentioned above please exercise extreme caution when using conductive tools such as tweezers and screwdrivers.
- [7] If used under conditions beyond its rated voltage, it may cause defects such as short-circuit or, depending on the circumstances, explosion or other permanent damages.
- [8] Be sure to wear insulated gloves when handling is required during operation.

After Use

- [9] The ROHM Evaluation Board contains the circuits which store the high voltage. Since it stores the charges even after the connected power circuits are cut, please discharge the electricity after using it, and please deal with it after confirming such electric discharge.
- [10] Protect against electric shocks by wearing insulated gloves when handling.

This evaluation board is intended for use only in research and development facilities and should be handled **only by qualified personnel familiar with all safety and operating procedures.**

We recommend carrying out operation in a safe environment that includes the use of high voltage signage at all entrances, safety interlocks, and protective glasses.

X-ON Electronics

Largest Supplier of Electrical and Electronic Components

Click to view similar products for [Power Management IC Development Tools](#) category:

Click to view products by [ROHM](#) manufacturer:

Other Similar products are found below :

[EVAL-ADM1168LQEBZ](#) [EVB-EP5348UI](#) [MIC23451-AAAYFL EV](#) [MIC5281YMME EV](#) [DA9063-EVAL](#) [ADP122-3.3-EVALZ](#) [ADP130-0.8-EVALZ](#) [ADP130-1.2-EVALZ](#) [ADP130-1.5-EVALZ](#) [ADP130-1.8-EVALZ](#) [ADP1712-3.3-EVALZ](#) [ADP1714-3.3-EVALZ](#) [ADP1715-3.3-EVALZ](#) [ADP1716-2.5-EVALZ](#) [ADP1740-1.5-EVALZ](#) [ADP1752-1.5-EVALZ](#) [ADP1828LC-EVALZ](#) [ADP1870-0.3-EVALZ](#) [ADP1871-0.6-EVALZ](#) [ADP1873-0.6-EVALZ](#) [ADP1874-0.3-EVALZ](#) [ADP1882-1.0-EVALZ](#) [ADP199CB-EVALZ](#) [ADP2102-1.25-EVALZ](#) [ADP2102-1.875EVALZ](#) [ADP2102-1.8-EVALZ](#) [ADP2102-2-EVALZ](#) [ADP2102-3-EVALZ](#) [ADP2102-4-EVALZ](#) [ADP2106-1.8-EVALZ](#) [ADP2147CB-110EVALZ](#) [AS3606-DB](#) [BQ24010EVM](#) [BQ24075TEVM](#) [BQ24155EVM](#) [BQ24157EVM-697](#) [BQ24160EVM-742](#) [BQ24296MEVM-655](#) [BQ25010EVM](#) [BQ3055EVM](#) [NCV891330PD50GEVB](#) [ISLUSBI2CKIT1Z](#) [LM2744EVAL](#) [LM2854EVAL](#) [LM3658SD-AEV/NOPB](#) [LM3658SDEV/NOPB](#) [LM3691TL-1.8EV/NOPB](#) [LM4510SDEV/NOPB](#) [LM5033SD-EVAL](#) [LP38512TS-1.8EV](#)