

1ch Gate Driver Providing Galvanic Isolation 2500Vrms Isolation Voltage

BM60051FV-C

General Description

The BM60051FV-C is a gate driver with an isolation voltage of 2500Vrms, I/O delay time of 260ns, minimum input pulse width of 180ns, and incorporates the fault signal output function, under voltage lockout (UVLO) function, short circuit protection (SCP) function, active miller clamping function, temperature monitoring function, switching controller function and output state feedback function.

Key Specifications

■ Isolation Voltage:	2500 [Vrms] (Max)
■ Maximum Gate Drive Voltage:	24 [V] (Max)
■ I/O Delay Time:	260 [ns] (Max)
■ Minimum Input Pulse Width:	180 [ns] (Max)

Packages

SSOP-B28W

W(Typ) x D(Typ) x H(Max)
9.2mm x 10.4mm x 2.4mm

Features

- Fault signal output function
- Under voltage lockout function
- Short circuit protection function
- Active Miller Clamping
- Temperature monitor
- Switching controller
- Output State Feedback Function
- UL1577 Recognized:File No. E356010
- AEC-Q100 Qualified (Note 1)
- (Note 1:Grade1)

Applications

- Automotive isolated IGBT/MOSFET inverter gate drive.
- Automotive DC-DC converter.
- Industrial inverters system.
- UPS system.

Typical Application Circuit

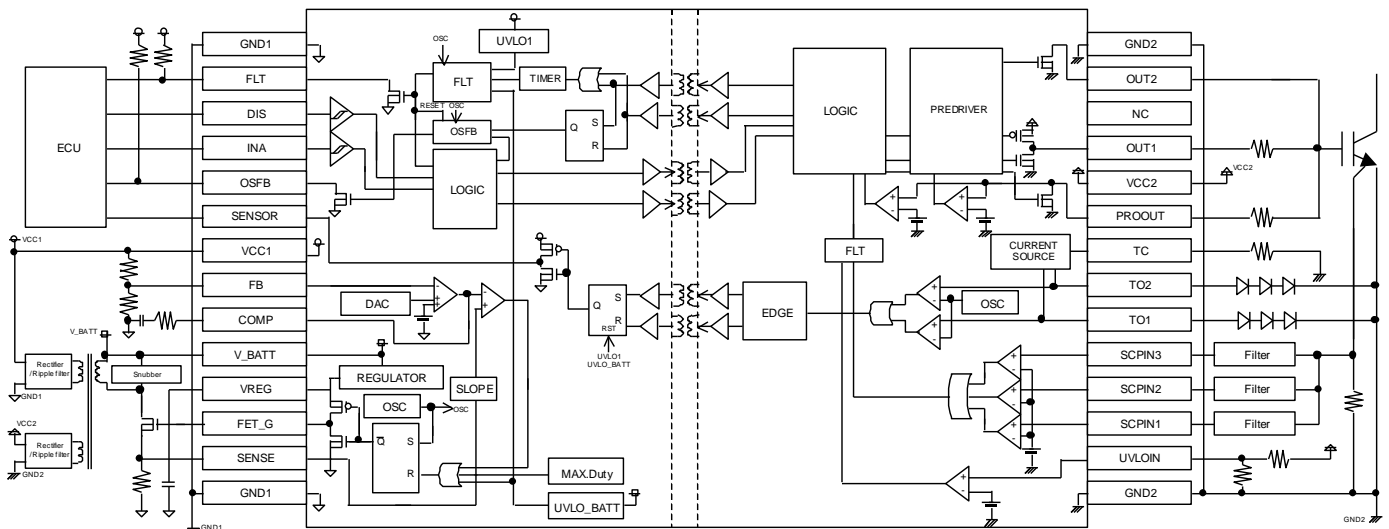

Figure 1. Typical Application Circuit

○Product structure : Silicon integrated circuit ○This product has no designed protection against radioactive rays

Recommended Range Of External Constants

Pin Name	Symbol	Recommended Value			Unit
		Min	Typ	Max	
TC ^(Note2)	R _{TC}	1.25	-	50	kΩ
TC ^(Note3)	R _{TC}	0.1	1	10	MΩ
VBATT	C _{VBATT}	3	-	-	μF
VCC1	C _{VCC1}	0.2	-	-	μF
VCC2	C _{VCC2}	0.4	-	-	μF
VREG	C _{VREG}	0.1	1	10	μF

(Note2) Use Temperature monitor
 (Note3) No use Temperature monitor

Pin Configuration
(TOP VIEW)

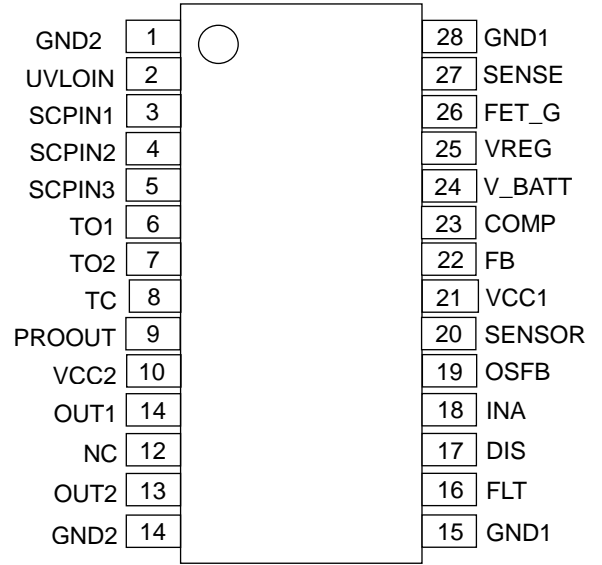

Figure 2. Pin configuration

Pin Descriptions

Pin No.	Pin Name	Function
1	GND2	Output-side ground pin
2	UVLOIN	Output-side UVLO setting pin
3	SCPIN1	Short circuit current detection pin 1
4	SCPIN2	Short circuit current detection pin 2
5	SCPIN3	Short circuit current detection pin 3
6	TO1	Constant current output pin / sensor voltage input pin 1
7	TO2	Constant current output pin / sensor voltage input pin 2
8	TC	Constant current setting resistor connection pin
9	PROOUT	Soft turn-OFF pin /Gate voltage input pin
10	VCC2	Output-side power supply pin
11	OUT1	Output pin
12	NC	No connect
13	OUT2	Output pin for Miller Clamp
14	GND2	Output-side ground pin
15	GND1	Input-side ground pin
16	FLT	Fault output pin
17	DIS	Input enabling signal input pin
18	INA	Control input pin
19	OSFB	Output state feedback output pin
20	SENSOR	Temperature information output pin
21	VCC1	Input-side power supply pin
22	FB	Error amplifier inverting input pin for switching controller
23	COMP	Error amplifier output pin for switching controller
24	V_BATT	Main power supply pin
25	VREG	Power supply pin for driving MOS FET for switching controller
26	FET_G	MOS FET control pin for switching controller
27	SENSE	Current feedback resistor connection pin for switching controller
28	GND1	Input-side ground pin

Absolute Maximum Ratings

Parameter	Symbol	Rating	Unit
Main Power Supply Voltage	$V_{BATTMAX}$	-0.3 to +40.0 ^(Note 4)	V
Input-Side Control Block Supply Voltage	V_{CC1MAX}	-0.3 to +7.0 ^(Note 4)	V
Output-Side Supply Voltage	V_{CC2MAX}	-0.3 to +30.0 ^(Note 5)	V
INA, DIS Pin Input Voltage	V_{INMAX}	-0.3 to + $V_{CC1}+0.3V$ or +7.0V ^(Note 4)	V
FLT, OSFB Pin Input Voltage	V_{FLTMAX}	-0.3 to +7.0V ^(Note 4)	V
FLT Pin, OSFB Pin Output Current	I_{FLT}	10	mA
SENSOR Pin Output Current	I_{SENSOR}	10	mA
FB Pin Input Voltage	V_{FBMAX}	-0.3 to + $V_{CC1}+0.3V$ or +7.0V ^(Note 4)	V
FED_G Pin Output Current (Peak5 μ s)	I_{FET_GPEAK}	1000	mA
SCPIN1 Pin, SCPIN2 Pin, SCPIN3 Pin Input Voltage	$V_{SCPINMAX}$	-0.3 to +6.0 ^(Note 5)	V
UVLOIN Pin Input Voltage	$V_{UVLOINMAX}$	-0.3 to $V_{CC2}+0.3$ ^(Note 5)	V
TO1 Pin, To2 Pin Input Voltage	V_{TOMAX}	-0.3 to $V_{CC2}+0.3$ ^(Note 5)	V
TO1 Pin, TO2 Pin Output Current	I_{TOMAX}	8	mA
OUT1 Pin Output Current (Peak5 μ s)	$I_{OUT1PEAK}$	5000 ^(Note 6)	mA
OUT2 Pin Output Current (Peak5 μ s)	$I_{OUT2PEAK}$	5000 ^(Note 6)	mA
PROOUT Pin Output Current (Peak5 μ s)	$I_{PROOUTPEAK5}$	2500 ^(Note 6)	mA
PROOUT Pin Output Current (Peak10 μ s)	$I_{PROOUTPEAK10}$	1000 ^(Note 6)	mA
Power Dissipation	P_d	1.12 ^(Note 7)	W
Operating Temperature Range	T_{opr}	-40 to +125	°C
Storage Temperature Range	T_{stg}	-55 to +150	°C
Junction Temperature	T_{jmax}	+150	°C

(Note 4) Relative to GND1

(Note 5) Relative to GND2

(Note 6) Should not exceed P_d and $T_j=150^\circ\text{C}$ (Note 7) Derate above $T_a=25^\circ\text{C}$ at a rate of 9.0mW/°C. Mounted on a glass epoxy of 114.3 mm × 76.2 mm × 1.6 mm.

Caution: Operating the IC over the absolute maximum ratings may damage the IC. The damage can either be a short circuit between pins or an open circuit between pins and the internal circuitry. Therefore, it is important to consider circuit protection measures, such as adding a fuse, in case the IC is operated over the absolute maximum ratings.

Recommended Operating Conditions

Parameter	Symbol	Min	Max	Units
Main Power Supply Voltage	V_{BATT} ^(Note 8)	4.5	24.0	V
Input-side Control Block Supply Voltage	V_{CC1} ^(Note 8)	4.5	5.5	V
Output-side Supply Voltage	V_{CC2} ^(Note 9)	9	24	V
Output side UVLO voltage	V_{UV2TH} ^(Note 9)	6	-	V

(Note 8) GND1 reference

(Note 9) GND2 reference

Insulation Related Characteristics

Parameter	Symbol	Characteristic	Unit
Insulation Resistance ($V_{IO}=500V$)	R_s	>10 ⁹	Ω
Insulation Withstand Voltage / 1min	V_{ISO}	2500	Vrms
Insulation Test Voltage / 1sec	V_{ISO}	3000	Vrms

Electrical Characteristics

(Unless otherwise specified Ta=-40°C to125°C, V_{BATT}=5V to 24V, V_{CC1}=4.5V to 5.5V, V_{CC2}=9V to 24V)

Parameter	Symbol	Min	Typ	Max	Unit	Conditions
General						
Main Power Supply Circuit Current 1	I _{BATT1}	0.37	0.84	1.47	mA	FET_G Pin switching operating
Main Power Supply Circuit Current 2	I _{BATT2}	0.34	0.77	1.35	mA	FET_G Pin No Switching
Input Side Circuit Current 1	I _{CC11}	0.13	0.31	0.49	mA	OUT=L
Input Side Circuit Current 2	I _{CC12}	0.13	0.31	0.49	mA	OUT=H
Input Side Circuit Current 3	I _{CC13}	0.25	0.42	0.59	mA	INA =10kHz, Duty=50%
Input Side Circuit Current 4	I _{CC14}	0.31	0.53	0.74	mA	INA =20kHz, Duty=50%
Output Side Circuit Current	I _{CC2}	2.7	4.7	7.1	mA	RTC=10kΩ
Switching Power Supply Controller						
FET_G Output Voltage H1	V _{FETGH1}	4.5	5.0	5.5	V	I _{OUT} =0A(open)
FET_G Output Voltage H2	V _{FETGH2}	4.0	4.5	-	V	V _{BATT} =4.5V I _{OUT} =0A(open)
FET_G Output Voltage L	V _{FETGL}	0	-	0.3	V	I _{OUT} =0A(open)
FET_G ON-Resistance (Source-side)	R _{ONGH}	3	6	12	Ω	10mA
FET_G ON-Resistance (Sink-side)	R _{ONGL}	0.3	0.6	1.3	Ω	10mA
Oscillation Frequency	f _{OSC_SW}	80	100	120	kHz	
Soft-start Time	t _{SS}	-	-	50	ms	
FB Pin Threshold Voltage	V _{FB}	1.47	1.50	1.53	V	
FB Pin Input Current	I _{FB}	-0.8	0	+0.8	μA	
COMP Pin Sink Current	I _{COMPSINK}	-160	-80	-40	μA	
COMP Pin Source Current	I _{COMPSOURCE}	40	80	160	μA	
V _{BATT} UVLO OFF Voltage	V _{UVLOBATTH}	4.05	4.25	4.45	V	
V _{BATT} UVLO ON Voltage	V _{UVLOBATTL}	3.95	4.15	4.35	V	
Maximum ON DUTY	D _{ONMAX}	75	85	95	%	
Logic Block						
Logic High Level Input Voltage	V _{INH}	0.7×V _{CC1}	-	V _{CC1}	V	INA, DIS
Logic Low Level Input Voltage	V _{INL}	0	-	0.3×V _{CC1}	V	INA, DIS
Logic Pull-Down Resistance	R _{IND}	25	50	100	kΩ	INA
Logic Pull-Up Resistance	R _{INU}	25	50	100	kΩ	DIS
Logic Input Filtering Time	t _{INFIL}	80	130	180	ns	INA
DIS Input Filtering Time	T _{DISFIL}	4	10	20	μs	
DIS Input Delay Time	t _{DDIS}	4	10	20	μs	
Output						
OUT1 ON-Resistance (Source-side)	R _{ONH}	0.2	0.55	1.3	Ω	I _{OUT} =40mA
OUT1 ON-Resistance (Sink-side)	R _{ONL}	0.2	0.55	1.3	Ω	I _{OUT} =40mA
OUT1 Maximum Current	I _{OUTMAX}	5.0	-	-	A	V _{CC2} =15V Guaranteed by design
PROOUT ON-Resistance	R _{ONPRO}	0.5	1.2	2.7	Ω	I _{PROOUT} =40mA
Turn ON time	t _{PON}	140	200	260	ns	
Turn OFF time	t _{POFF}	140	200	260	ns	
Propagation Distortion	t _{PDIST}	-60	0	+60	ns	t _{POFF} - t _{PON}
Rise Time	t _{RISE}	-	30	50	ns	Load=1nF
Fall Time	t _{FALL}	-	30	50	ns	Load=1nF
OUT2 ON-Resistance	R _{ON2}	0.4	0.9	2.0	Ω	I _{OUT} =40mA
OUT2 ON Threshold Voltage	V _{OUT2ON}	1.8	2.0	2.2	V	
OUT2 Output Delay Time	t _{OUT2ON}	-	15	50	ns	
Common Mode Transient Immunity	CM	100	-	-	kV/μs	Design assurance

Electrical Characteristics - continued(Unless otherwise specified Ta=-40°C to 125°C, V_{BATT}=5V to 24V, V_{CC1}=4.5V to 5.5V, V_{CC2}=8V to 24V)

Parameter	Symbol	Min	Typ	Max	Unit	Conditions
Temperature Monitor						
TC Pin Voltage	V _{TC}	0.975	1.000	1.025	V	
TOx Pin Output Current	I _{TO}	0.97	1.00	1.03	mA	R _{TC} =10kΩ
SENSOR Output Frequency	f _{OSC_TO}	8	10	14	kHz	
SENSOR Output Duty1	D _{SENSOR1}	87	90	93	%	V _{TOx} =1.35V
SENSOR Output Duty2	D _{SENSOR2}	47	50.0	53	%	V _{TOx} =2.59V
SENSOR Output Duty3	D _{SENSOR3}	5	10	15	%	V _{TOx} =3.84V
TOx Pin Disconnect Detection Voltage	V _{TOH}	7	8	9	V	
SENSOR ON Resistance (Source-side)	R _{SENSORH}	-	60	160	Ω	I _{SENSOR} =5mA
SENSOR ON Resistance (Sink-side)	R _{SENSORL}	-	60	160	Ω	I _{SENSOR} =5mA
Protection Functions						
Input-side UVLO OFF Voltage	V _{UVLO1H}	4.05	4.25	4.45	V	
Input-side UVLO ON Voltage	V _{UVLO1L}	3.95	4.15	4.35	V	
Input-side UVLO Filtering Time	t _{UVLO1FIL}	2	10	30	μs	
Input-side UVLO Delay Time (OUT)	t _{DUVLO1OUT}	2	10	30	μs	
Input-side UVLO Delay Time (FLT)	t _{DUVLO1FLT}	2	10	30	μs	
Output-side UVLO OFF Threshold Voltage	V _{UVLO2H}	0.95	1.00	1.05	V	
Output-side UVLO ON Threshold Voltage	V _{UVLO2L}	0.85	0.90	0.95	V	
Output-side UVLO Filtering Time	t _{UVLO2FIL}	2	10	30	μs	
Output-side UVLO Delay Time (OUT)	t _{DUVLO2OUT}	2	10	30	μs	
Output-side UVLO Delay Time (FLT)	t _{DUVLO2FLT}	3	-	65	μs	
Short Current Detection Voltage	V _{SCDET}	0.67	0.70	0.73	V	
Short Current Detection Filtering Time	t _{SCPFIL}	0.15	0.30	0.45	μs	
Short Current Detection Delay time (OUT)	t _{DSCPOUT}	0.16	0.33	0.50	μs	OUT1=30kΩ Pull down
Short Current Detection Delay Time (PROOUT)	t _{DSCPPRO}	0.17	0.35	0.53	μs	PROOUT=30kΩ Pull up
Short Current Detection Delay Time (FLT)	t _{DSCPFLT}	1	-	35	μs	
Soft Turn OFF Release Time	t _{SCPOFF}	30	-	110	μs	OUT1=30kΩ Pull up
FLT Output ON-Resistance	R _{FLTL}	-	30	80	Ω	I _{FLT} =5mA
Fault Output Holding Time	t _{FLTRLS}	20	40	60	ms	
Gate State H Detection Threshold Voltage	V _{OSFBH}	4.5	5.0	5.5	V	
Gate State L Detection Threshold Voltage	V _{OSFBL}	4.0	4.5	5.0	V	
OSFB Output Filtering Time	t _{OSFBFIL}	1.5	2.0	2.5	μs	
OSFB Output ON-Resistance	R _{OSFB}	-	30	80	Ω	I _{OSFB} =5mA
OSFB Output Holding Time	t _{OSFBRLS}	20	40	60	ms	

UL1577 Ratings Table

Following values are described in UL Report.

Parameter	Values	Units	Conditions
Side 1 (Input Side) Circuit Current	1.37	mA	V_BATT=14V,VCC1=5.0V,OUT1=L
Side 2 (Output Side) Circuit Current	4.7	mA	VCC2=15V, OUT1=L
Side 1 (Input Side) Consumption Power	14.4	mW	V_BATT=14V,VCC1=5.0V,OUT1=L
Side 2 (Output Side) Consumption Power	70.5	mW	VCC2=15V, OUT1=L
Isolation Voltage	2500	Vrms	
Maximum Operating (Ambient) Temperature	125	°C	
Maximum Junction Temperature	150	°C	
Maximum Storage Temperature	150	°C	
Maximum Data Transmission Rate	2.7	MHz	

Typical Performance Curves

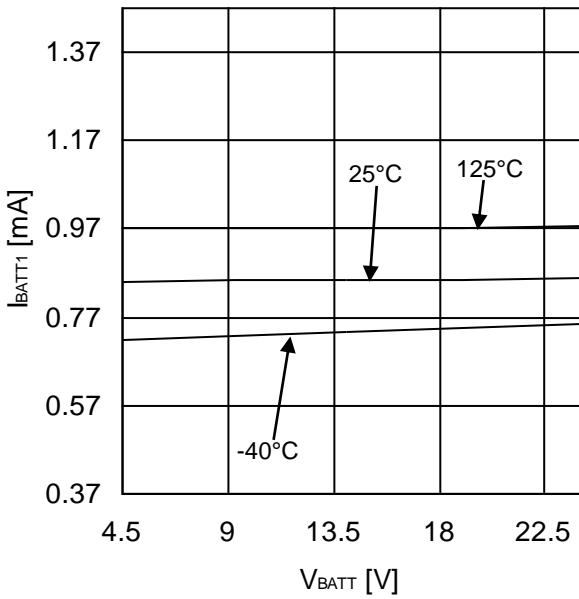

Figure 3. Main Power Supply Circuit Current 1 (FET_G Pin switching operating)

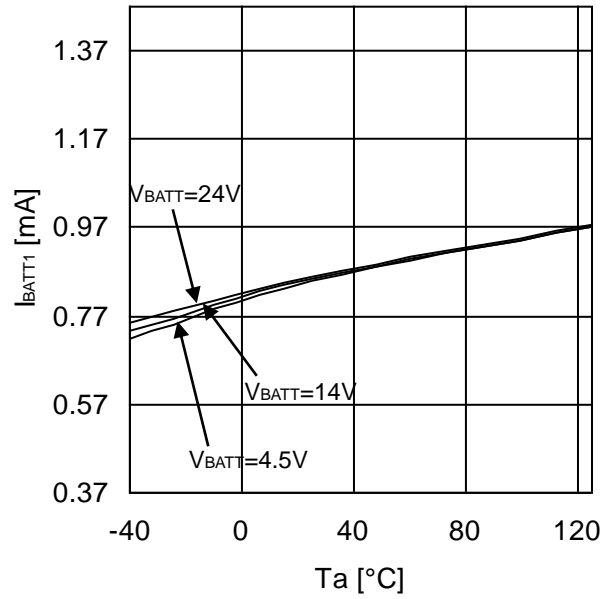

Figure 4. Main Power Supply Circuit Current 1 (FET_G Pin switching operating)

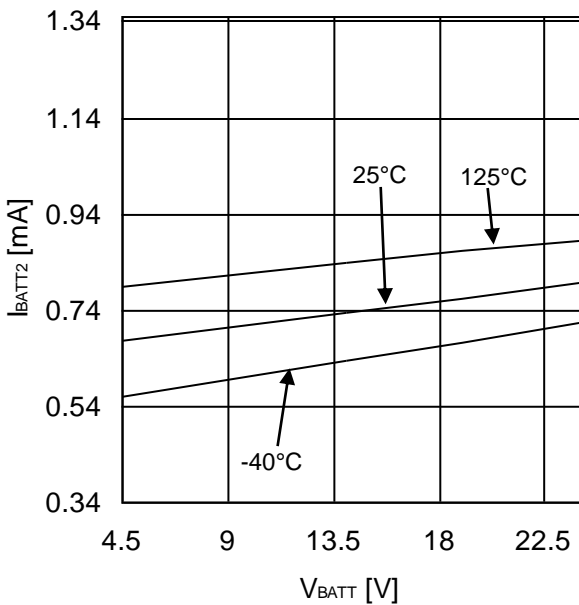

Figure 5. Main Power Supply Circuit Current 2 (FET_G Pin no switching)

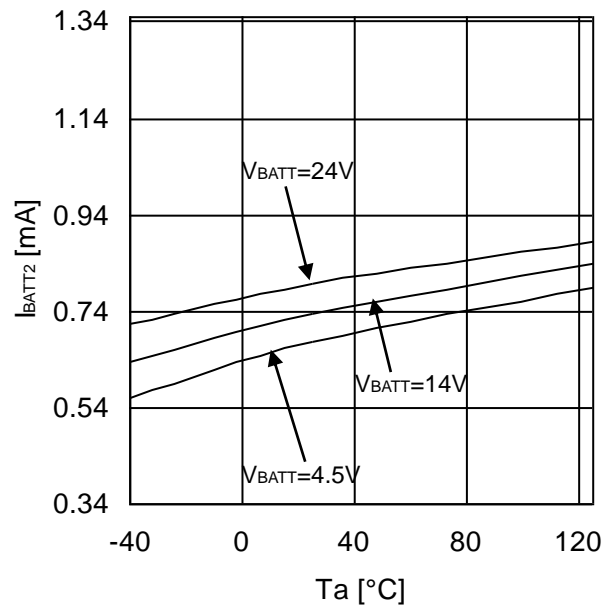

Figure 6. Main Power Supply Circuit Current 2 (FET_G Pin no switching)

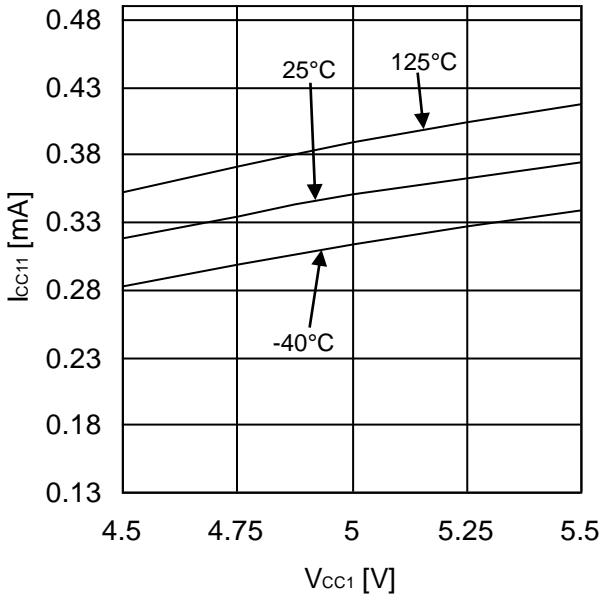

Figure 7. Input Side Circuit Current 1 (OUT1=L)

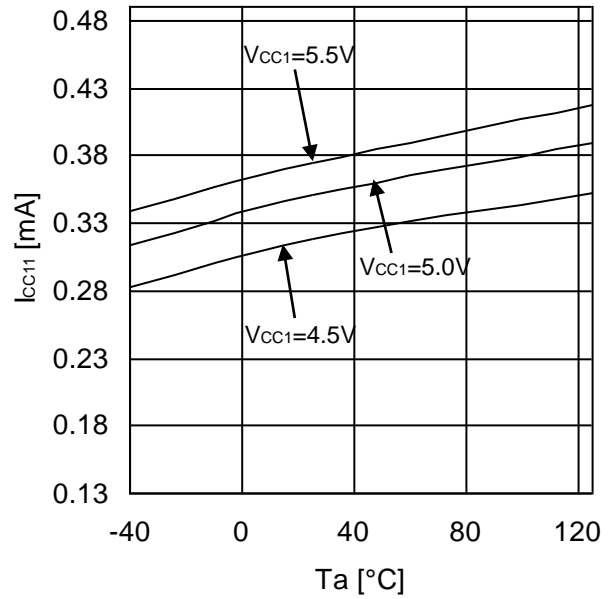

Figure 8. Input Side Circuit Current 1 (OUT1=L)

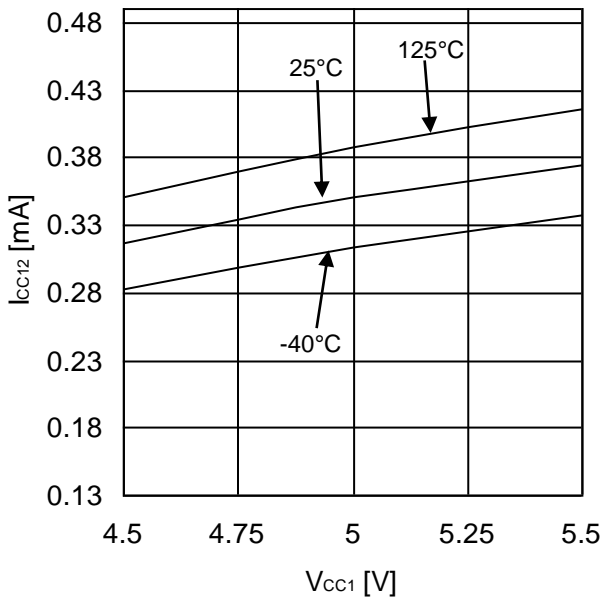

Figure 9. Input Side Circuit Current 2 (OUT1=H)

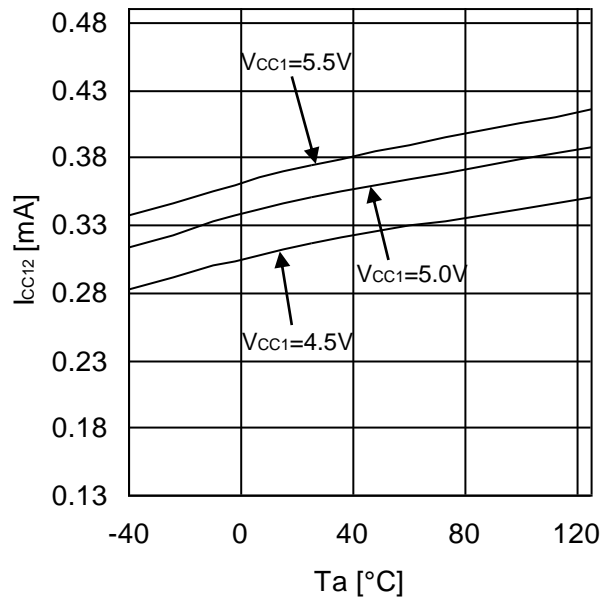

Figure 10. Input Side Circuit Current 2 (OUT1=H)

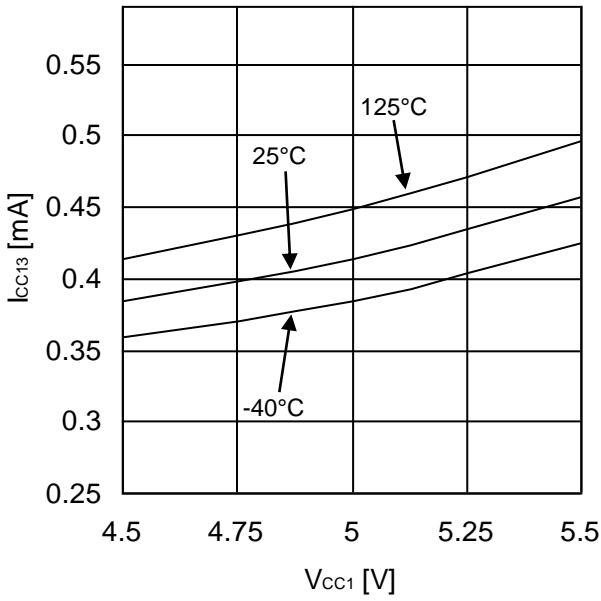

Figure 11. Input Side Circuit Current 3 (INA=10kHz, Duty=50%)

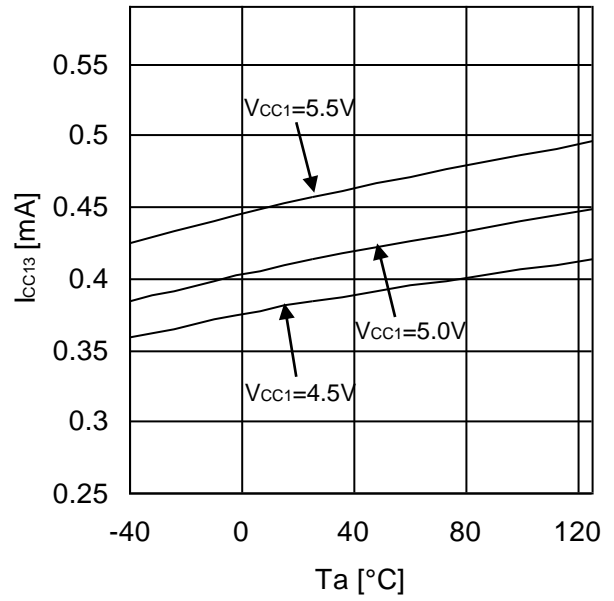

Figure 12. Input Side Circuit Current 3 (INA=10kHz, Duty=50%)

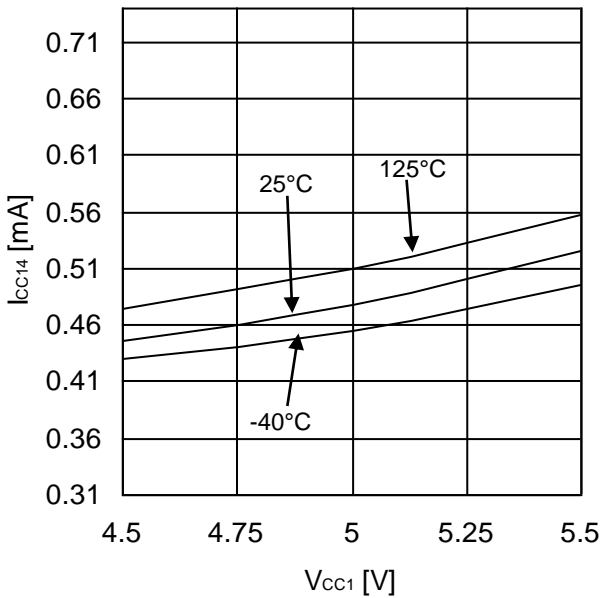

Figure 13. Input Side Circuit Current 4 (INA=20kHz, Duty=50%)

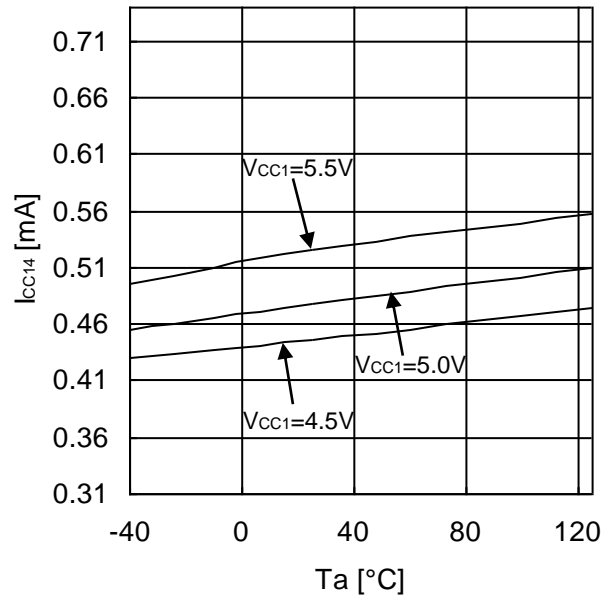

Figure 14. Input Side Circuit Current 4 (INA=20kHz, Duty=50%)

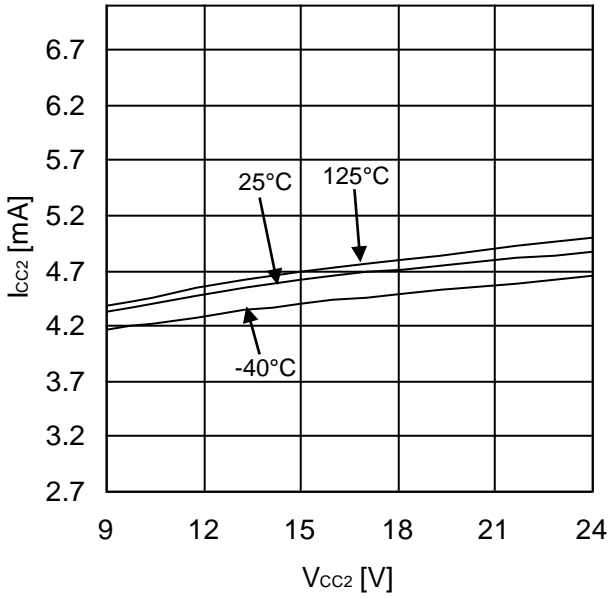

Figure 15. Output Side Circuit Current (OUT=L, R_{Tc}=10kΩ)

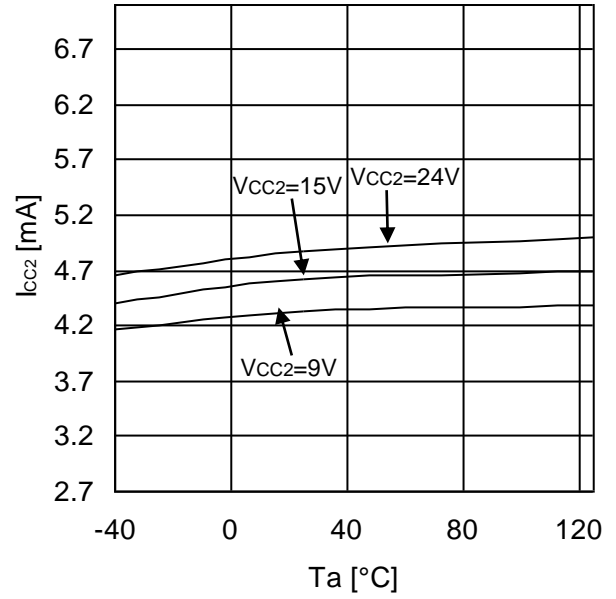

Figure 16. Output Side Circuit Current (OUT=L, R_{Tc}=10kΩ)

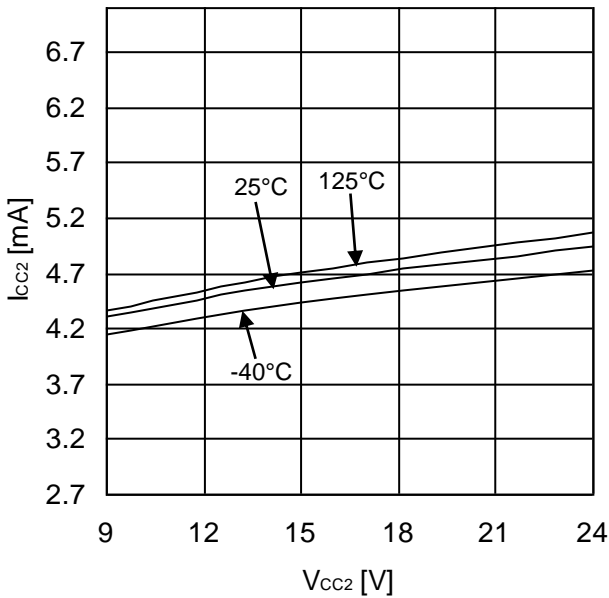

Figure 17. Output Side Circuit Current (OUT=H, R_{Tc}=10kΩ)

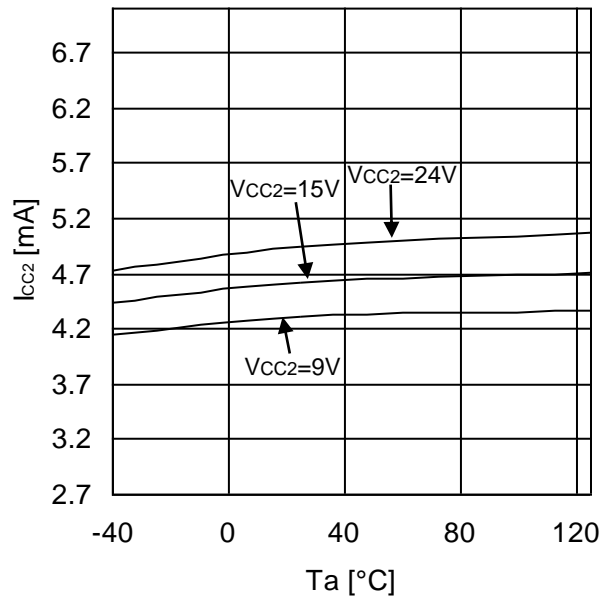

Figure 18. Output Side Circuit Current (OUT=H, R_{Tc}=10kΩ)

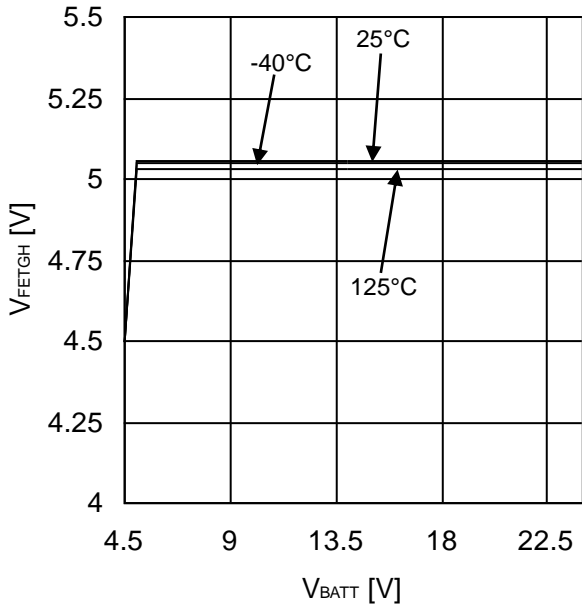

Figure 19. FET_G Output Voltage H1/H2

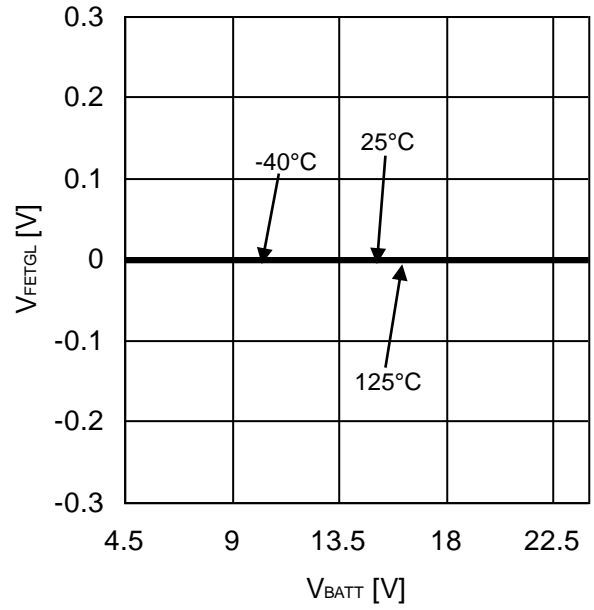

Figure 20. FET_G Output Voltage L

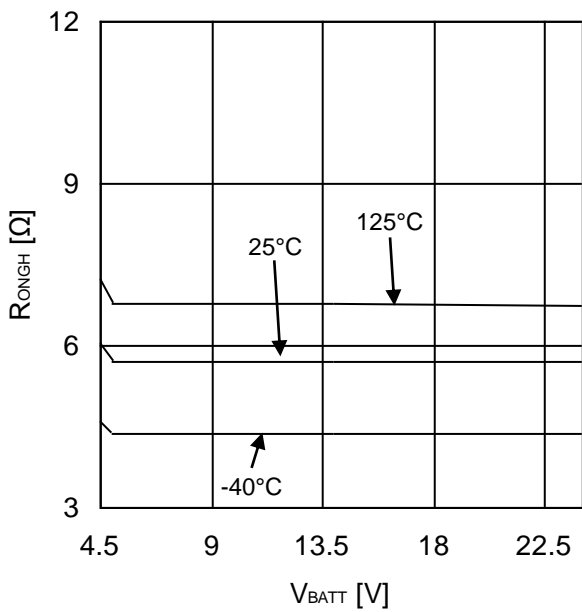

Figure 21. FET_G ON-Resistance (Source-side)

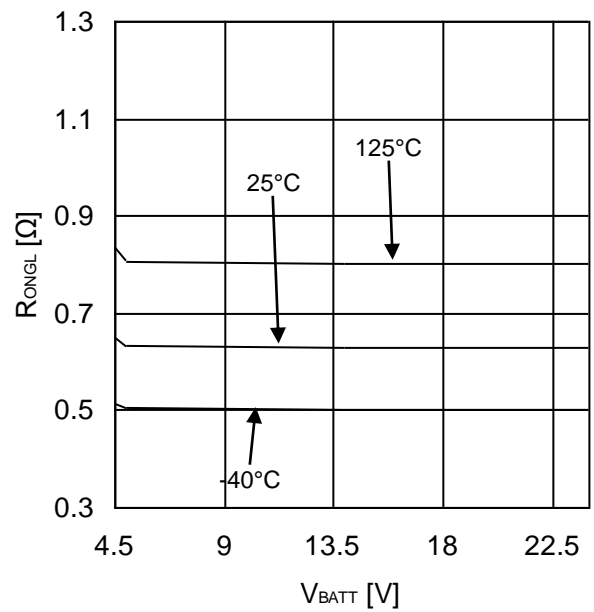

Figure 22. FET_G ON-Resistance (Sink-side)

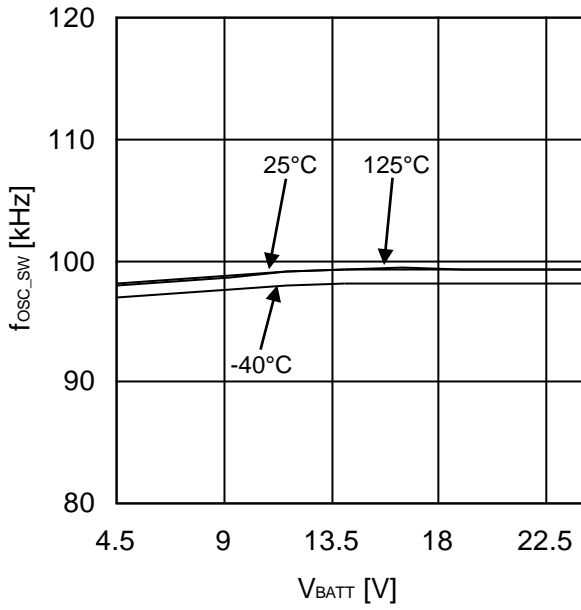

Figure 23. Oscillation Frequency

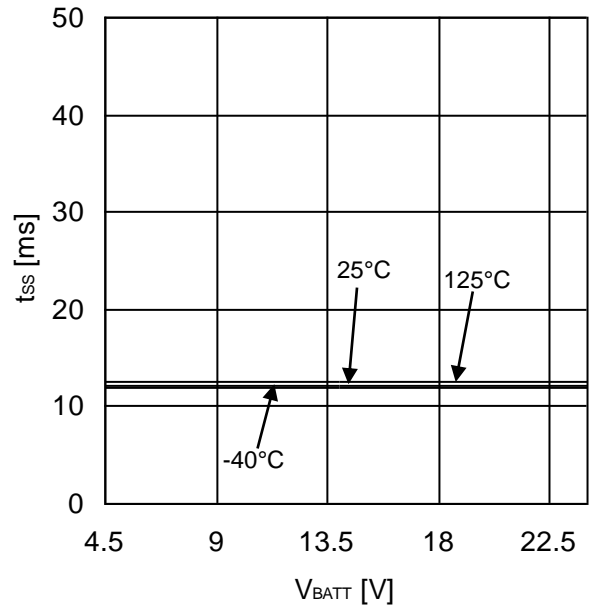

Figure 24. Soft-start Time

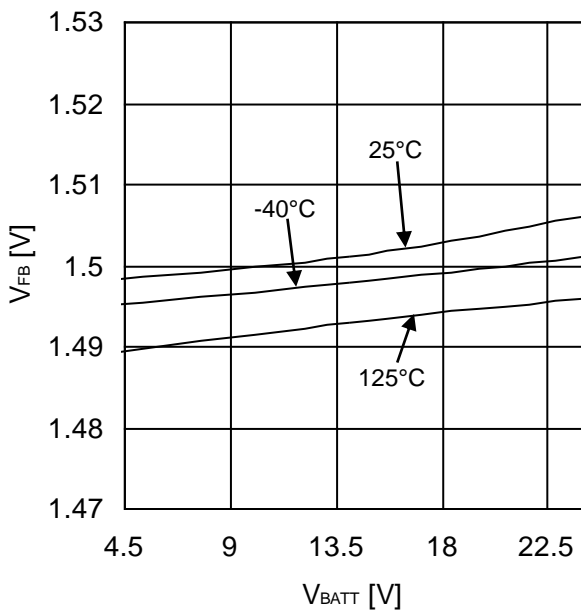

Figure 25. FB Pin Threshold Voltage

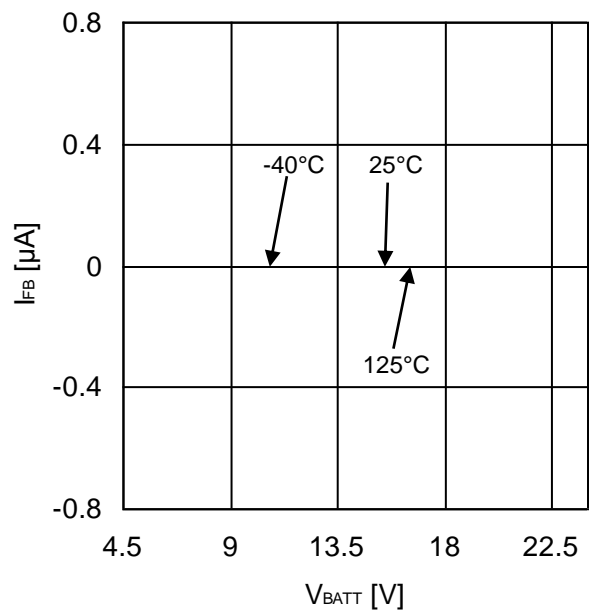

Figure 26. FB Pin Input Current

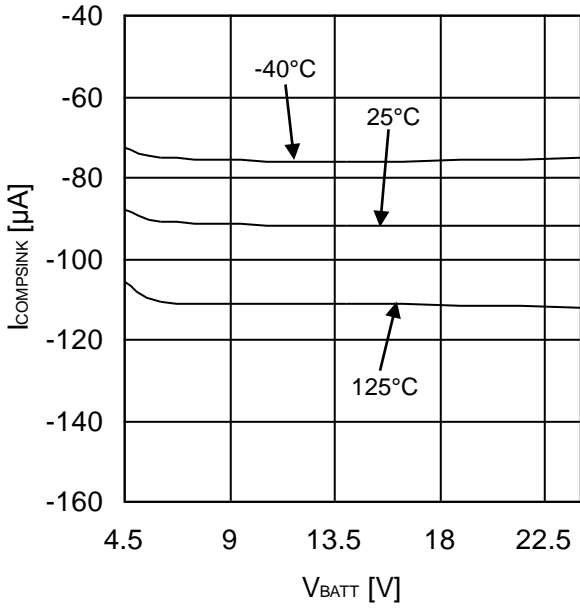

Figure 27. COMP COMP Pin Sink Current

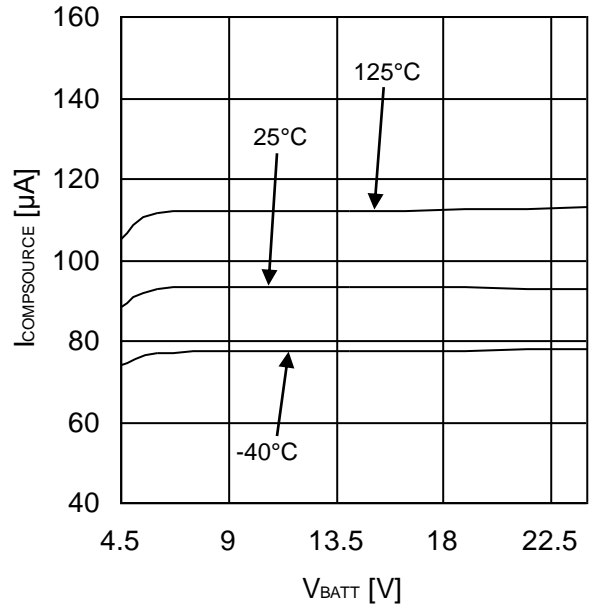

Figure 28. COMP Pin Source Current

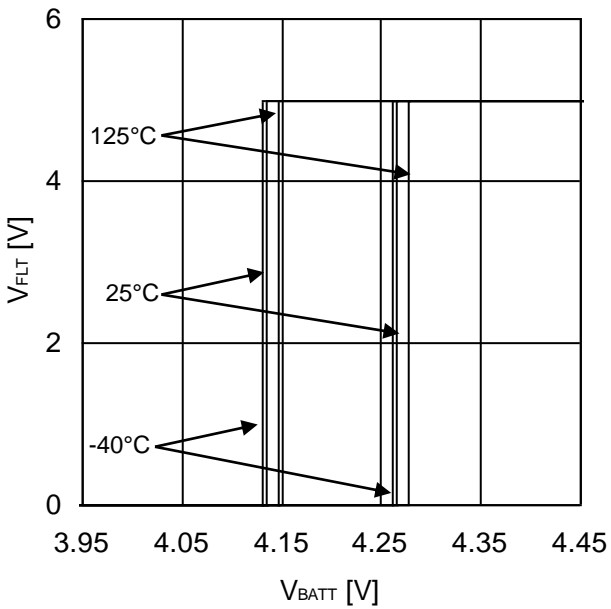

Figure 29. V_BATT UVLO ON/OFF Voltage

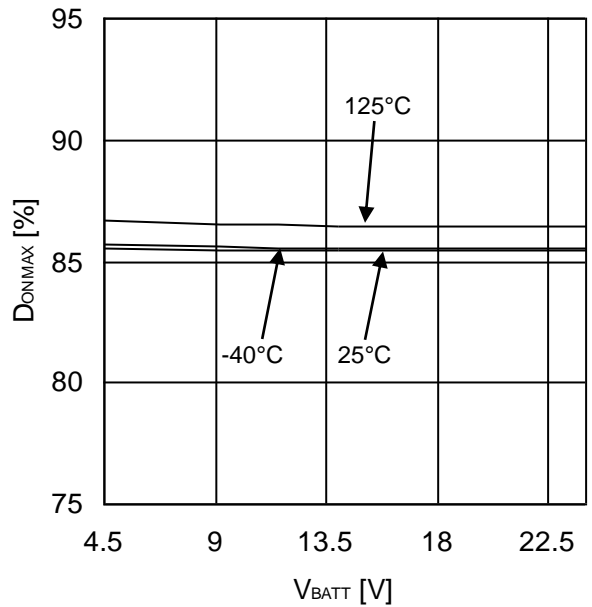

Figure 30. Maximum ON DUTY

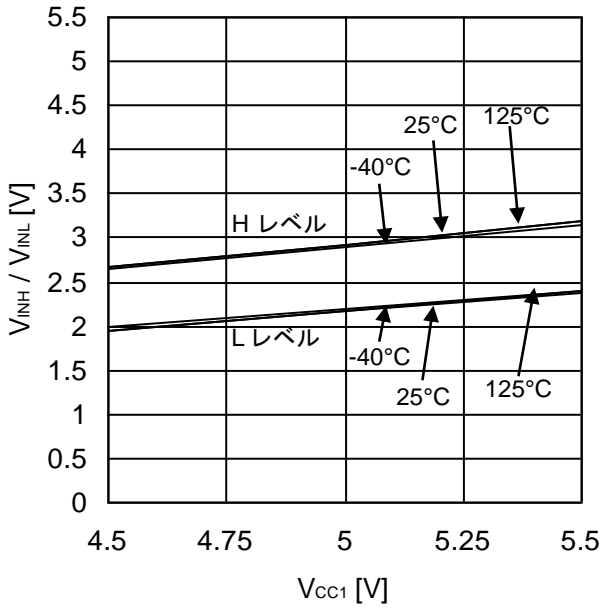

Figure 31. Logic High / Low Level Input Voltage (INA, DIS)

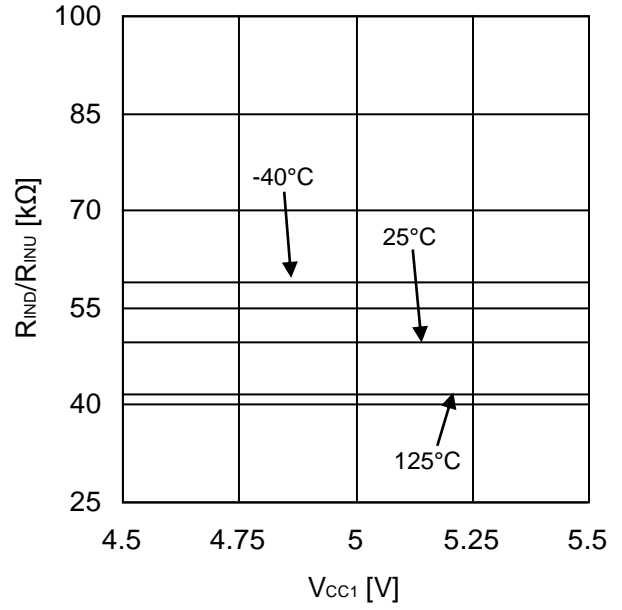

Figure 32. Logic Pull-Down Resistance (INA) Pull-Up Resistance (DIS)

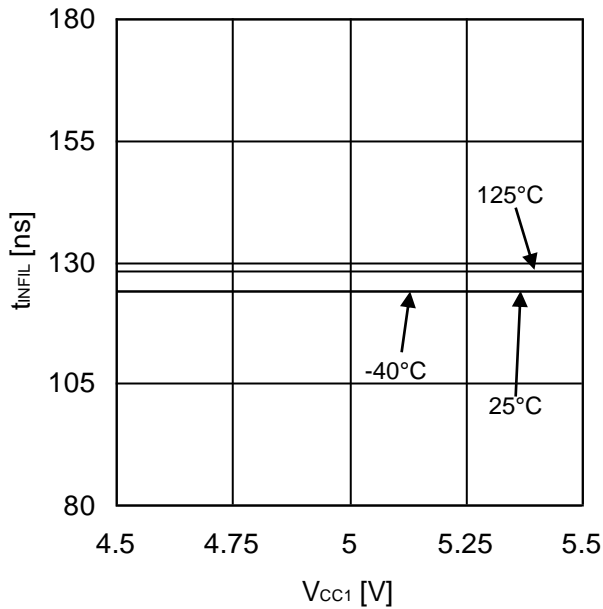

Figure 33. Logic Input Filtering Time (L pulse)

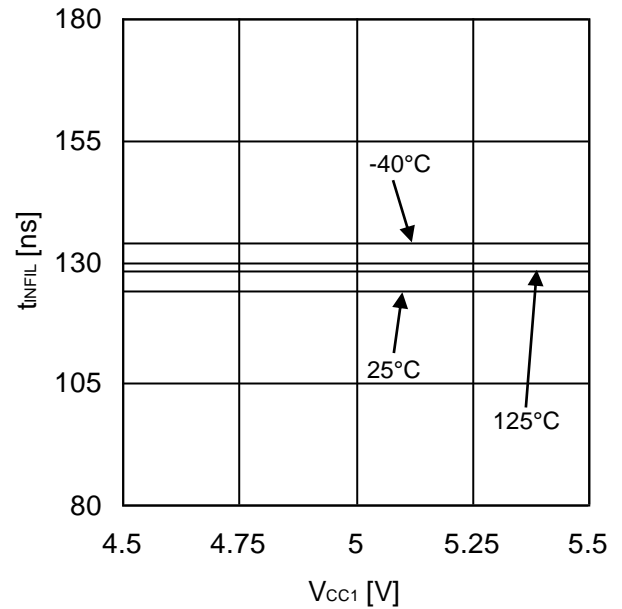

Figure 34. Logic Input Filtering Time (H pulse)

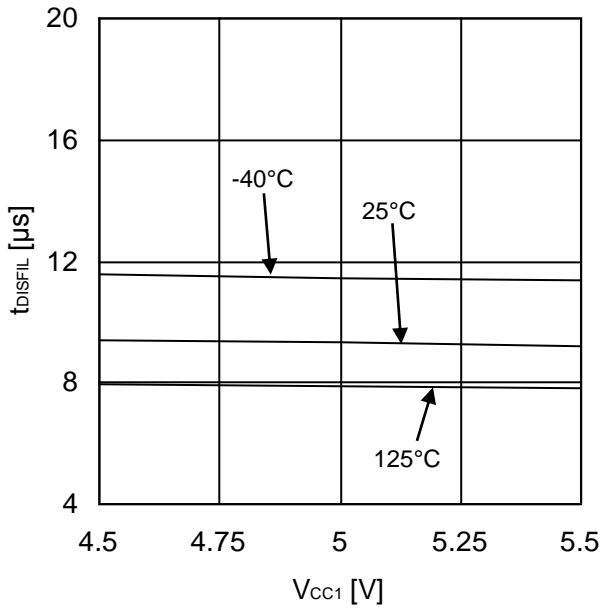

Figure 35. DIS Input Filtering Time

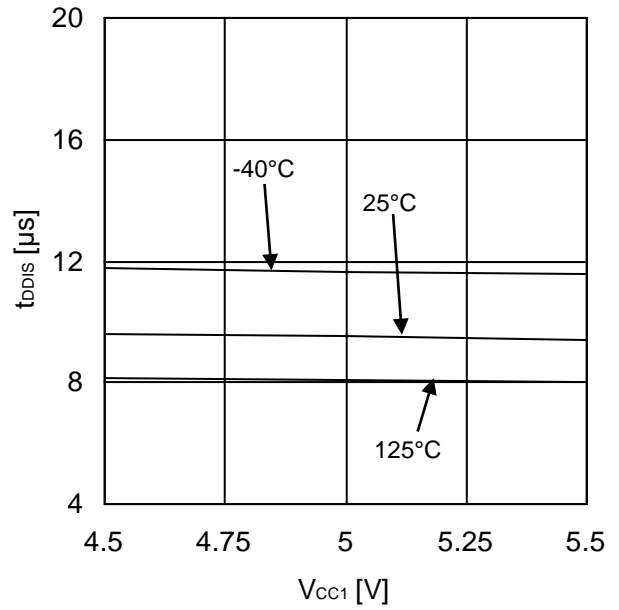

Figure 36. DIS Input Delay Time

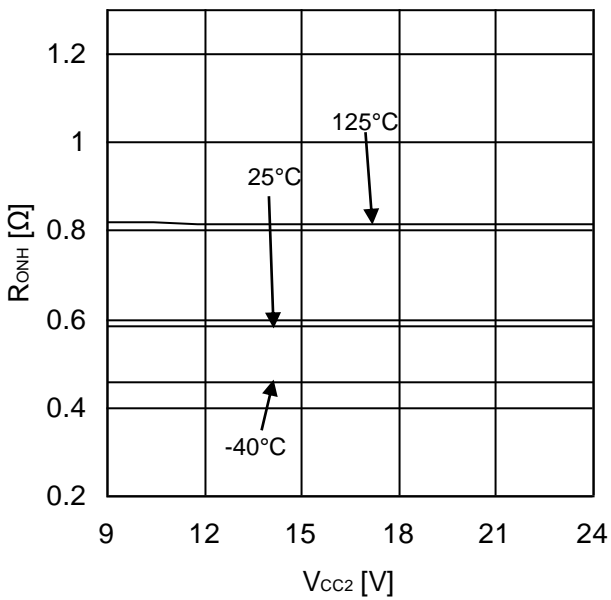

Figure 37. OUT1 ON-Resistance(Source-side)
($I_{OUT1}=40mA$)

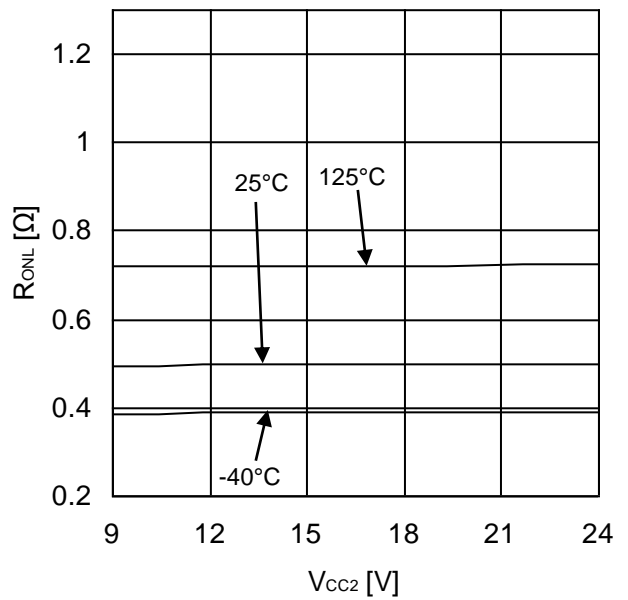

Figure 38. OUT1 ON-Resistance (Sink-side)
($I_{OUT1}=40mA$)

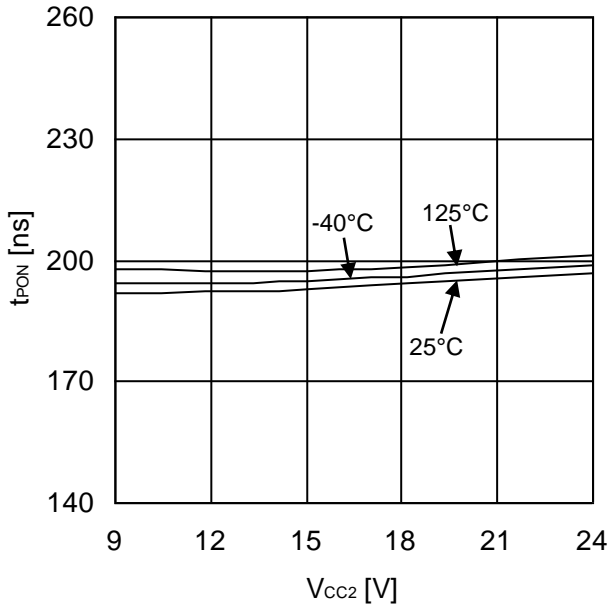

Figure 39. Turn ON time

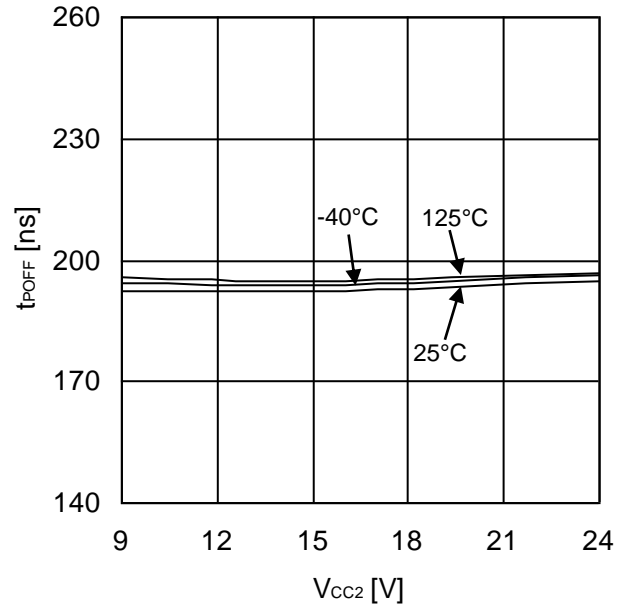

Figure 40. Turn OFF time

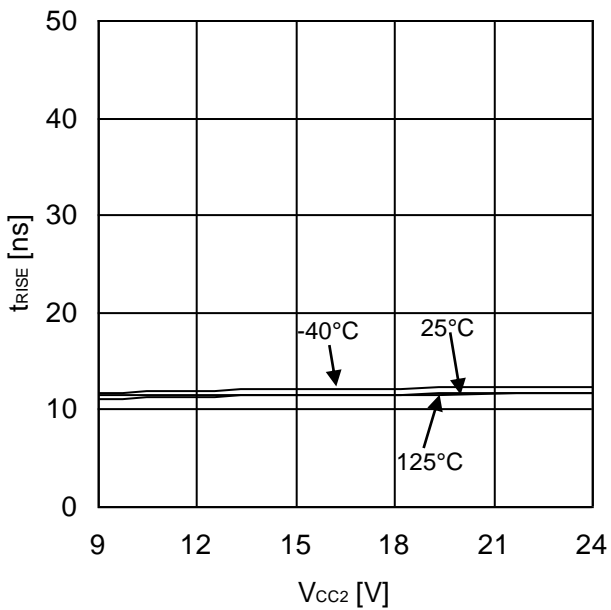

Figure 41. Rise time

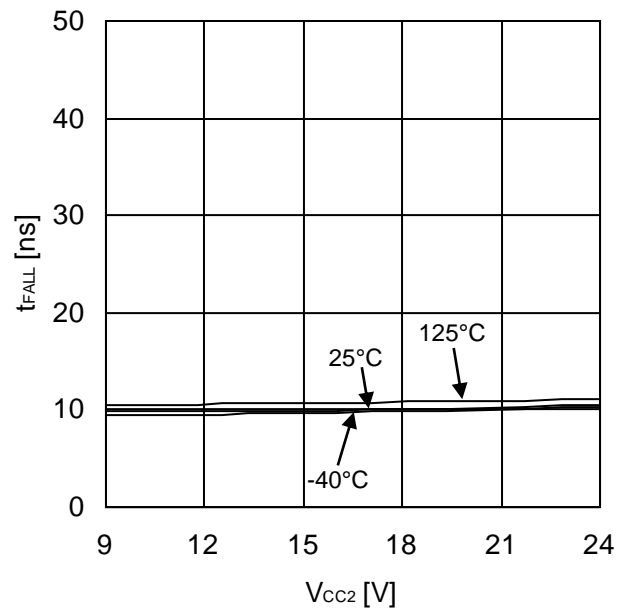

Figure 42. Fall time

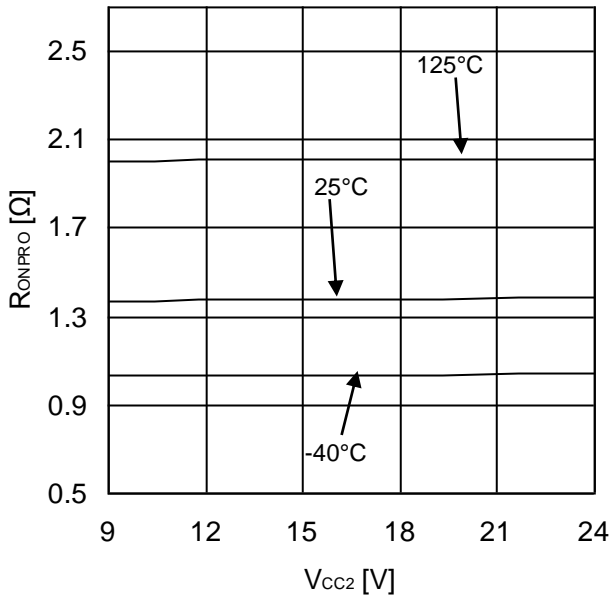

Figure 43. PROOUT ON-Resistance ($I_{PROOUT}=40mA$)

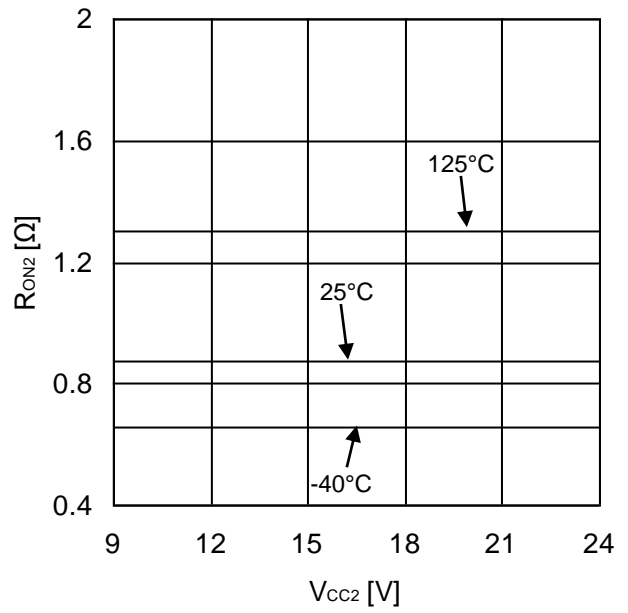

Figure 44. OUT2 ON-Resistance ($I_{OUT2}=40mA$)

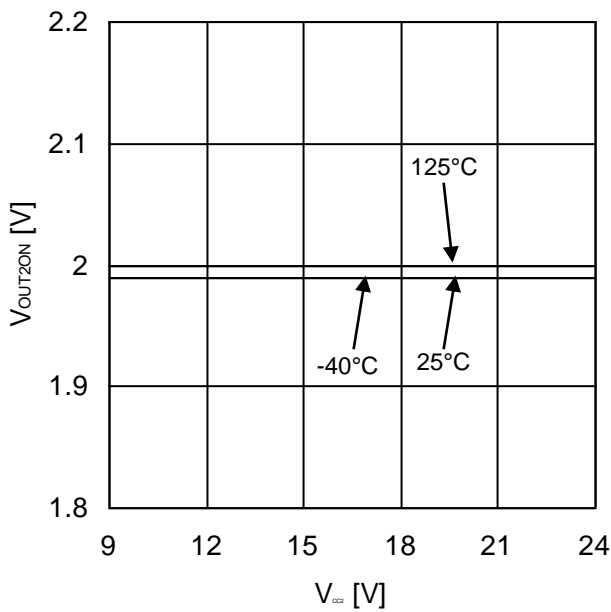

Figure 45. OUT2 ON Threshold Voltage

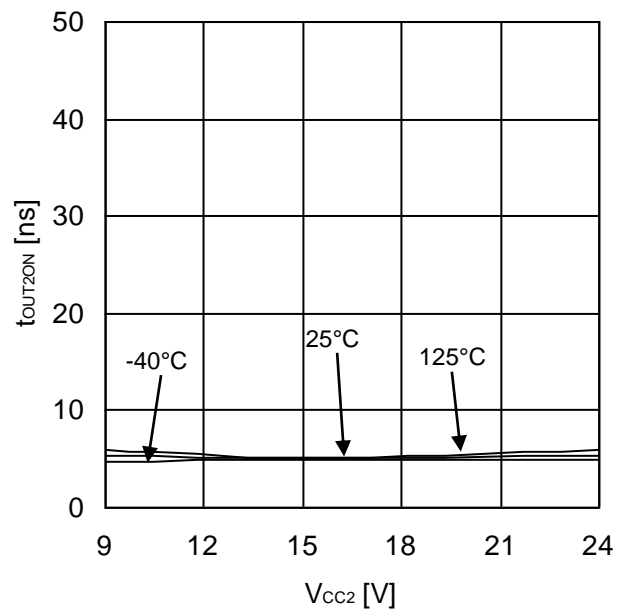

Figure 46. OUT2 Output Delay Time

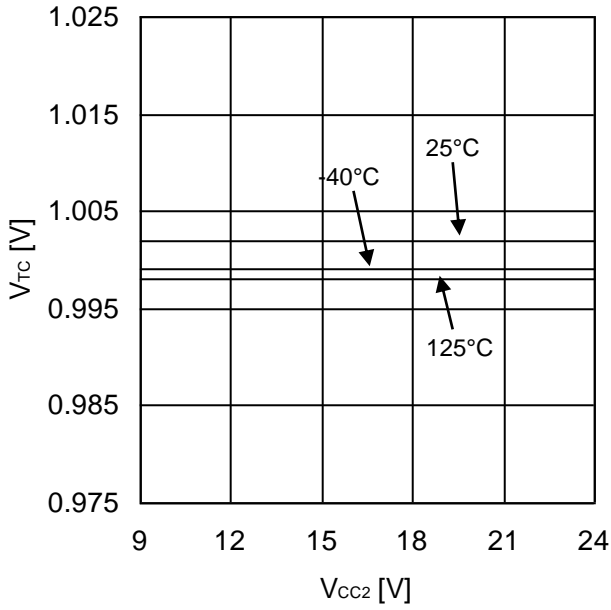

Figure 47. TC Pin Voltage

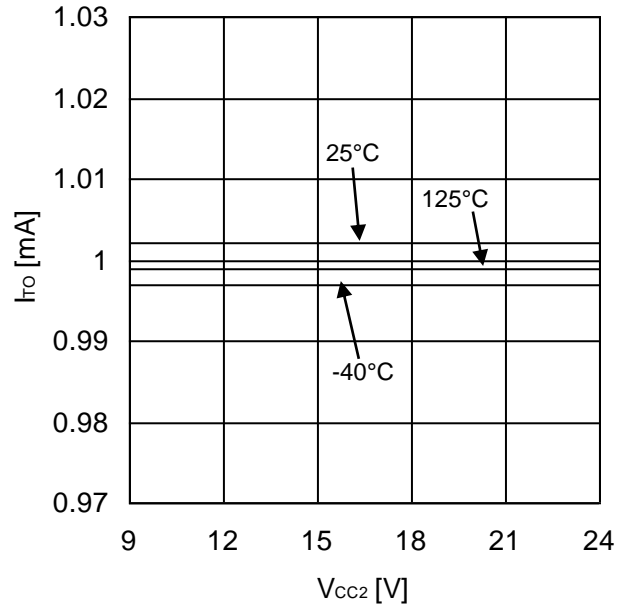

Figure 48. TOx Pin Output Current (RTC=10kΩ)

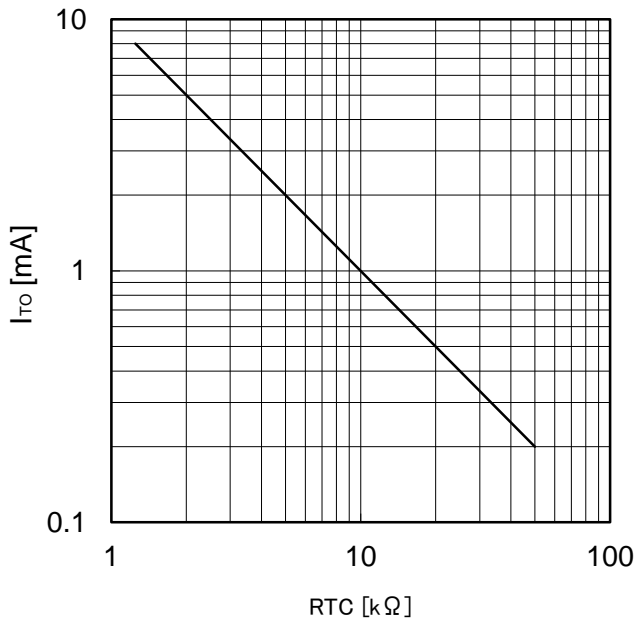

Figure 49. TOx Pin Output Current

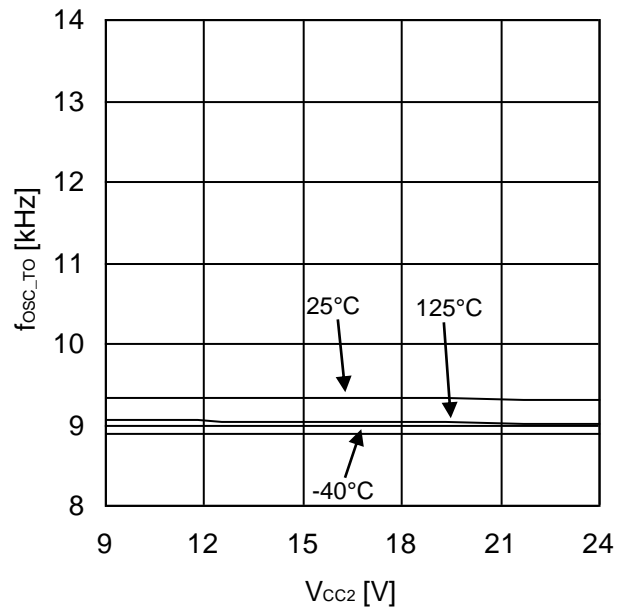

Figure 50. SENSOR Output Frequency

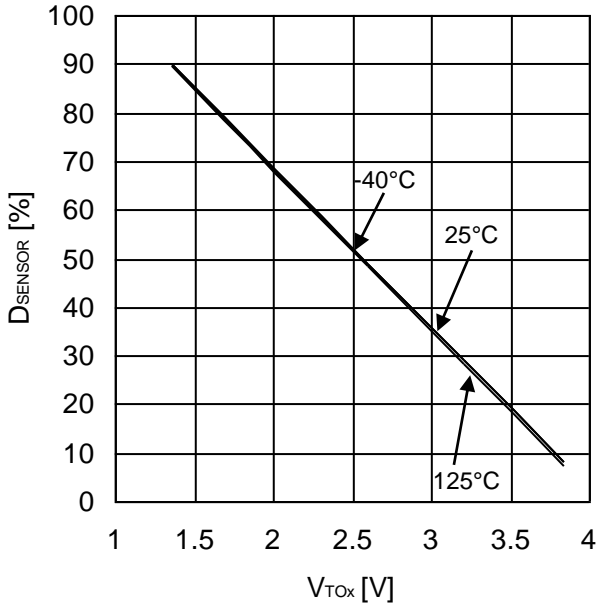

Figure 51. SENSOR Output Duty

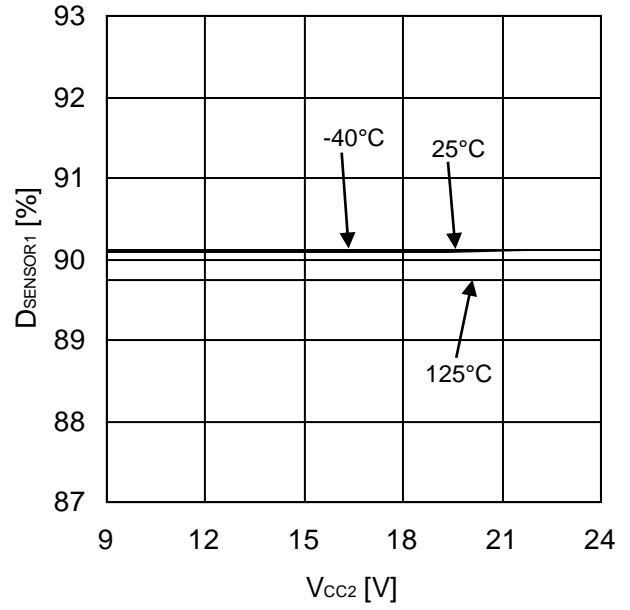

Figure 52. SENSOR Output Duty1
(V_{TOx}=1.35V)

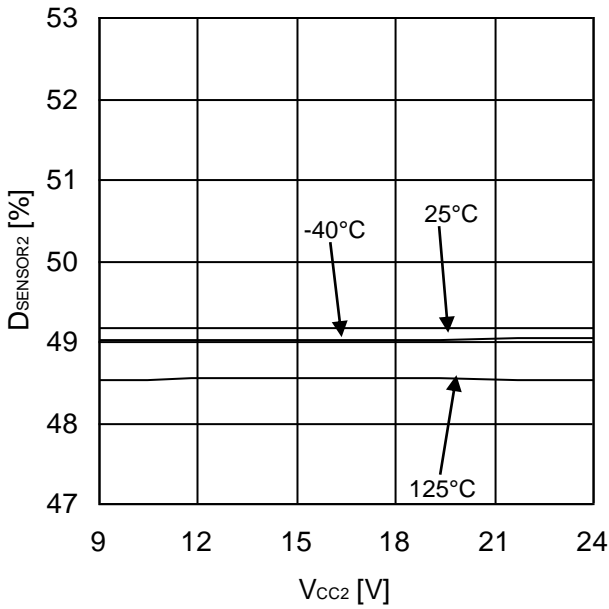

Figure 53. SENSOR Output Duty2
(V_{TOx}=2.59V)

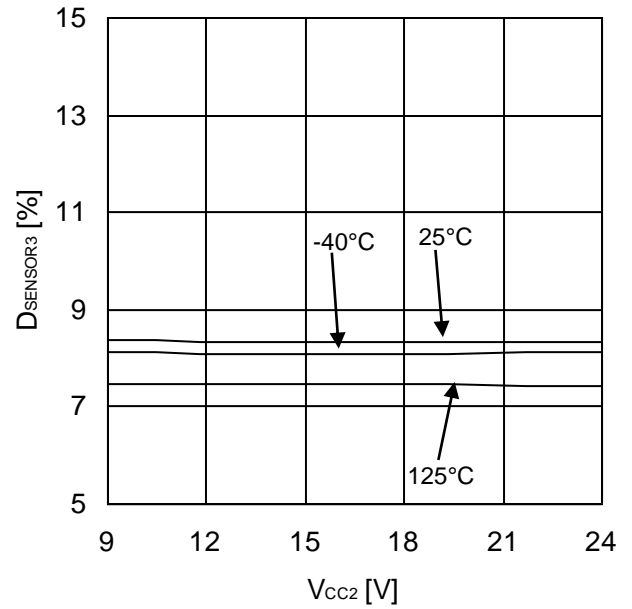

Figure 54. SENSOR Output Duty3
(V_{TOx}=3.84V)

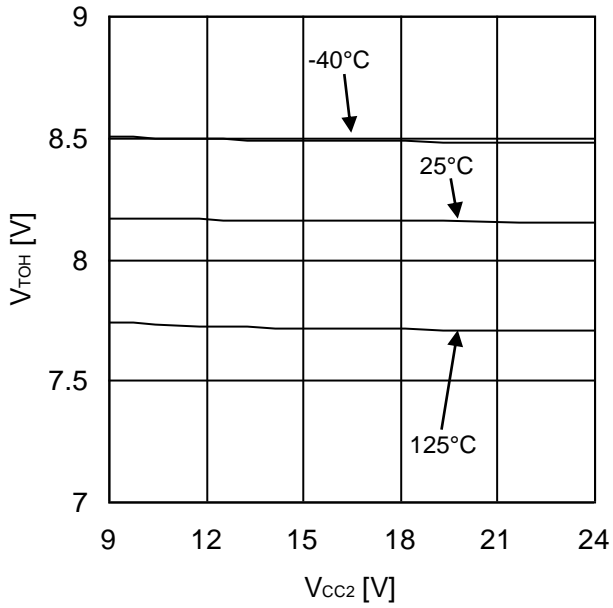

Figure 55. TOx Pin Disconnect Detection Voltage

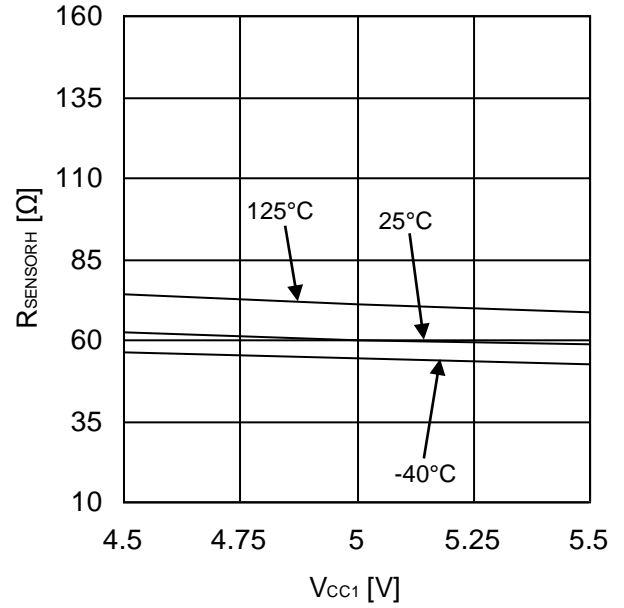

Figure 56. SENSOR ON Resistance(Source-side) ($I_{SEBSOR}=5mA$)

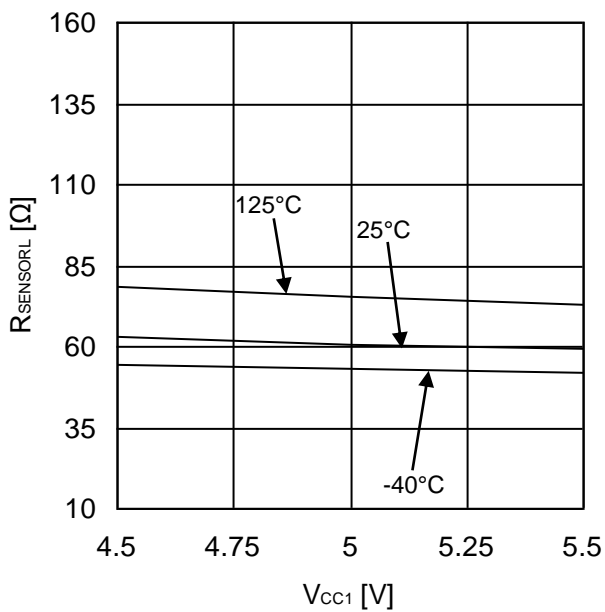

Figure 57. SENSOR ON Resistance (Sink-side) ($I_{SENSOR}=5mA$)

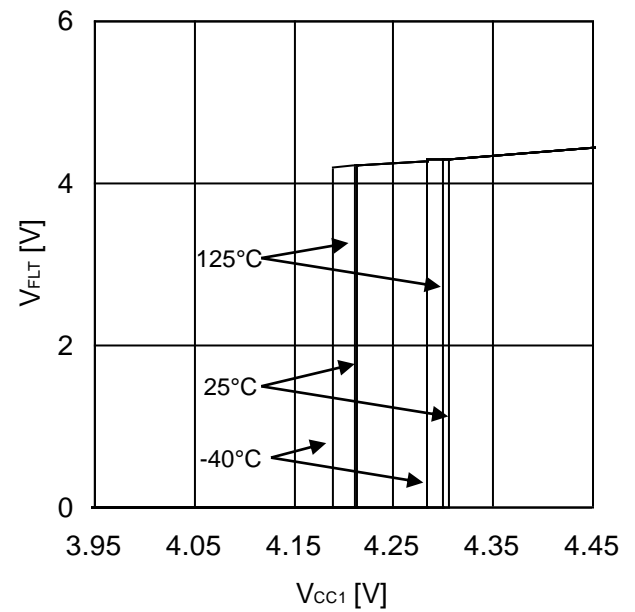

Figure 58. Input-side UVLO ON/OFF Voltage

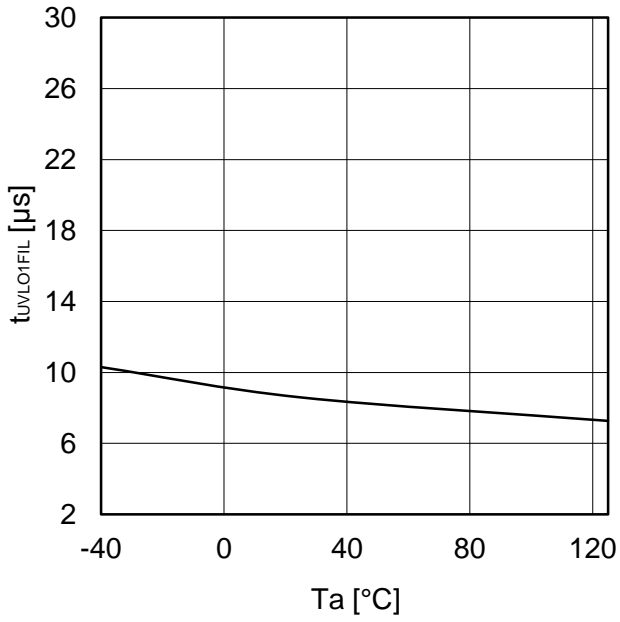

Figure 59. Input-side UVLO Filtering Time

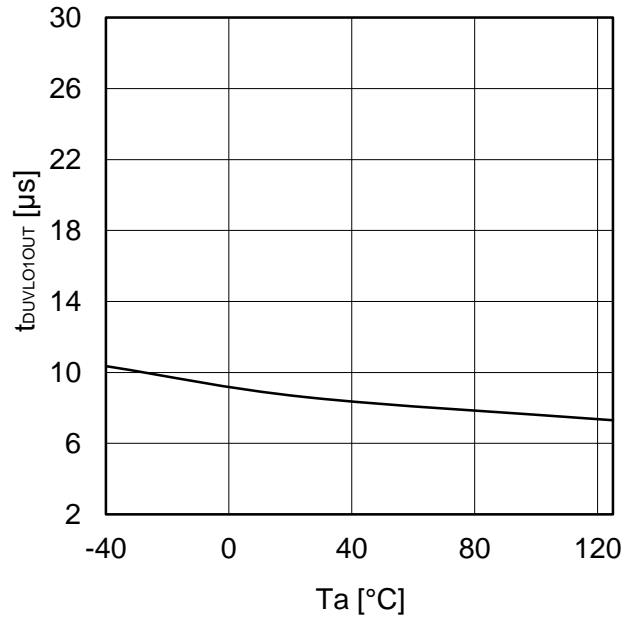

Figure 60. Input-side UVLO Delay Time (OUT1)

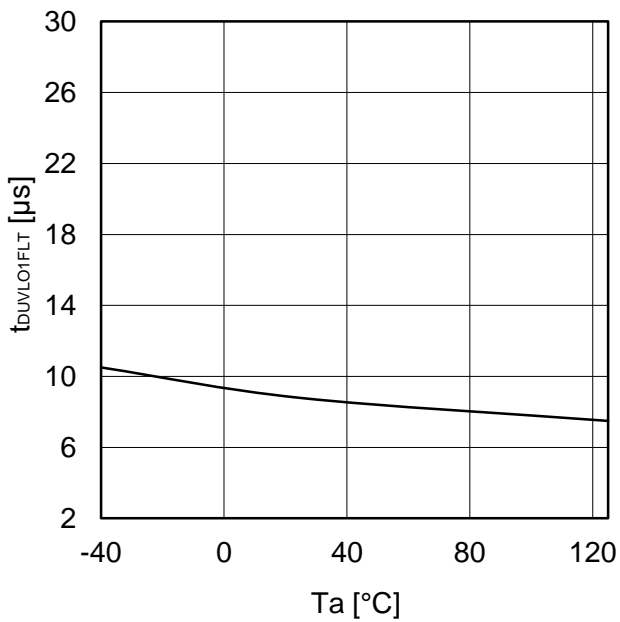

Figure 61. Input-side UVLO Delay Time (FLT)

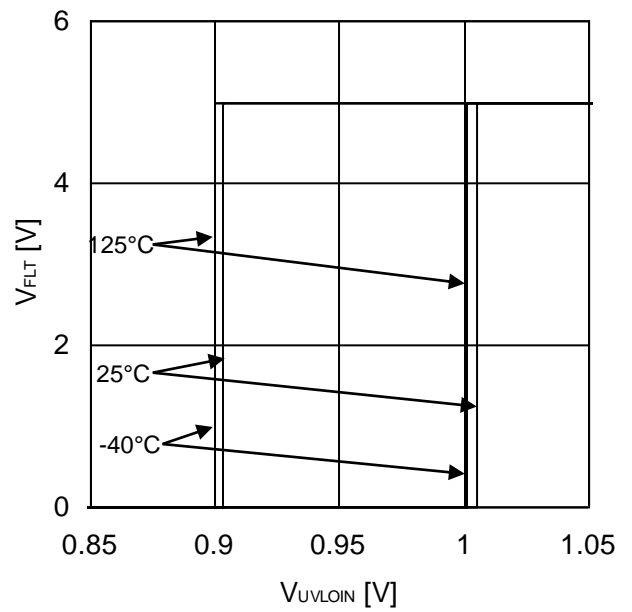

Figure 62. Output-side UVLO ON / OFF Threshold Voltage

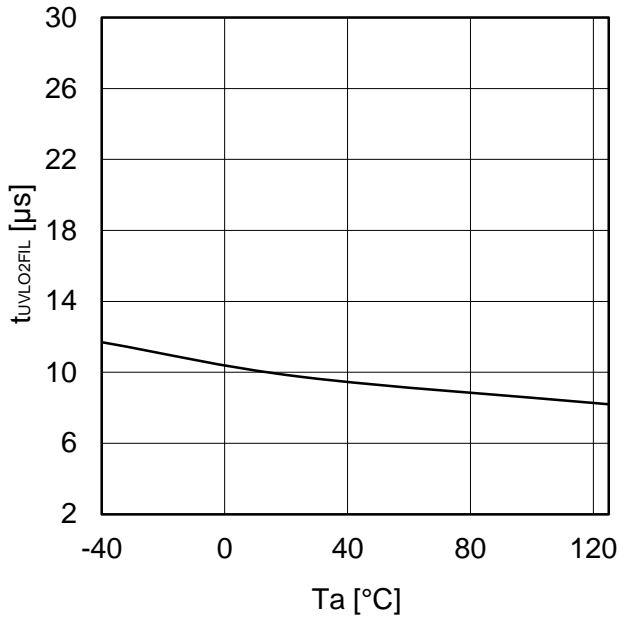

Figure 63. Output-side UVLO Filtering Time

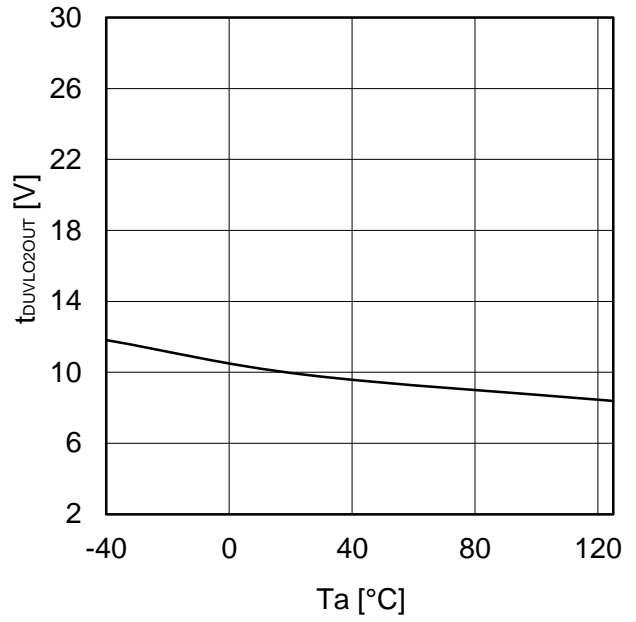

Figure 64. Output-side UVLO Delay Time (OUT1)

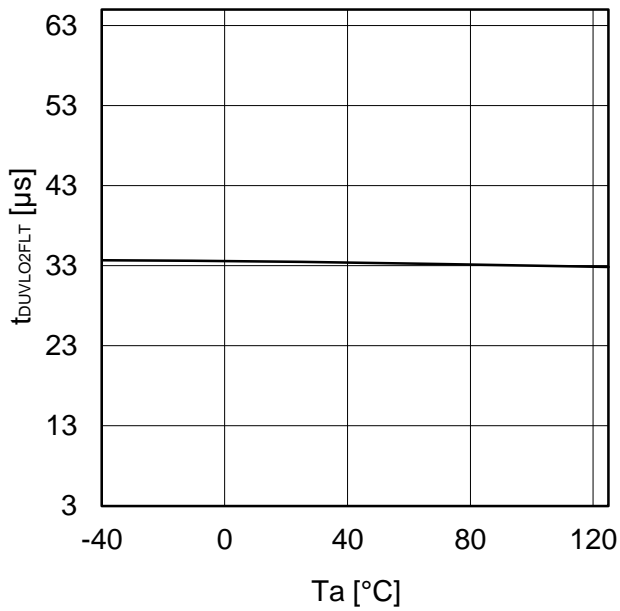

Figure 65. Output-side UVLO Delay Time (FLT)

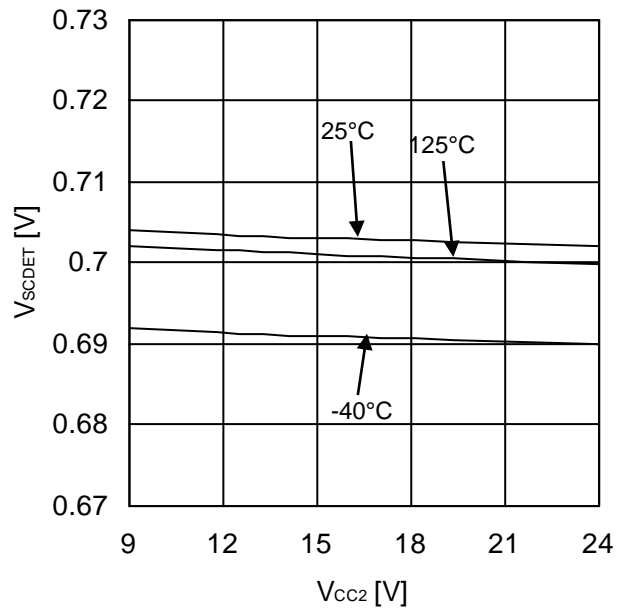

Figure 66. Short Current Detection Voltage

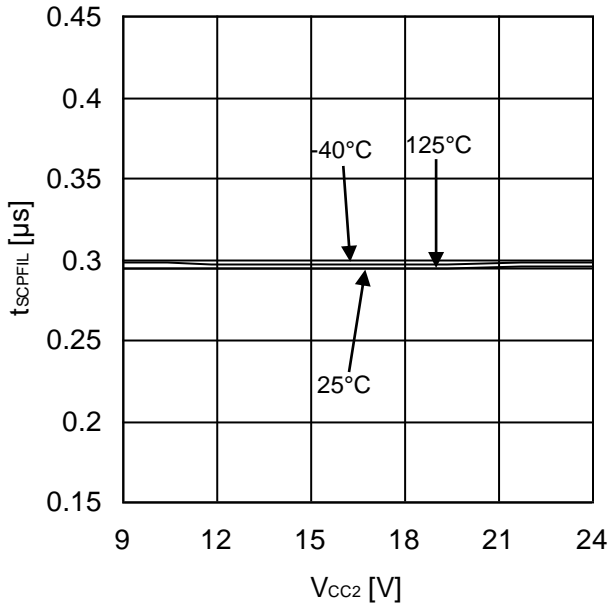

Figure 67. Short Current Detection Filtering Time

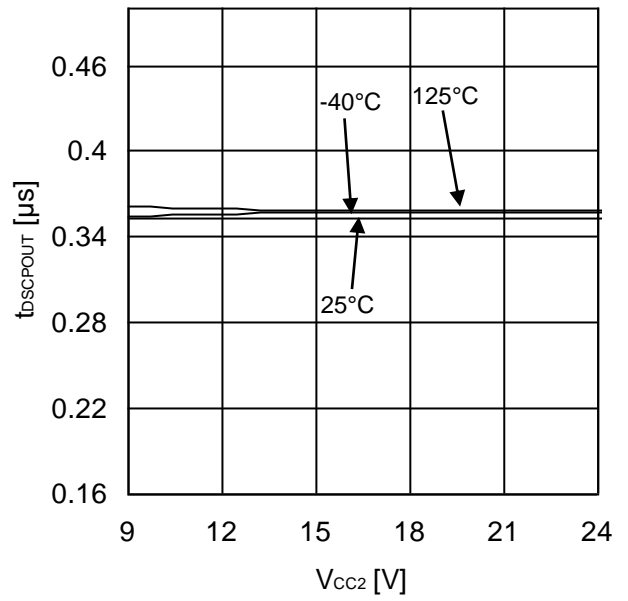

Figure 68. Short Current Detection Delay time (OUT1)

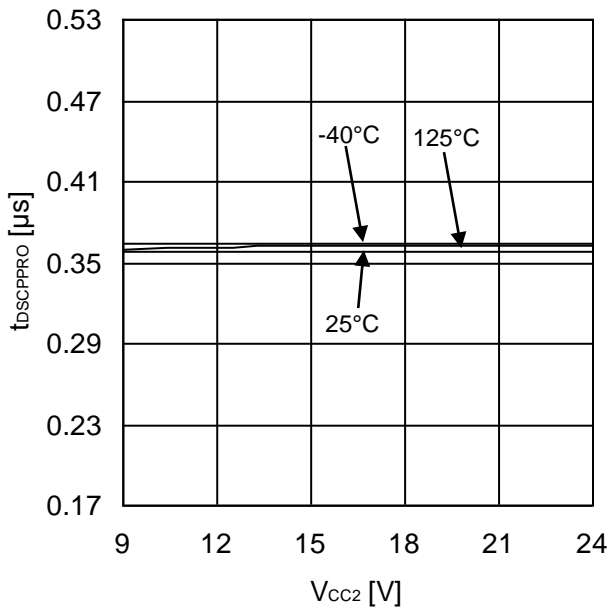

Figure 69. Short Current Detection Delay time (PROOUT)

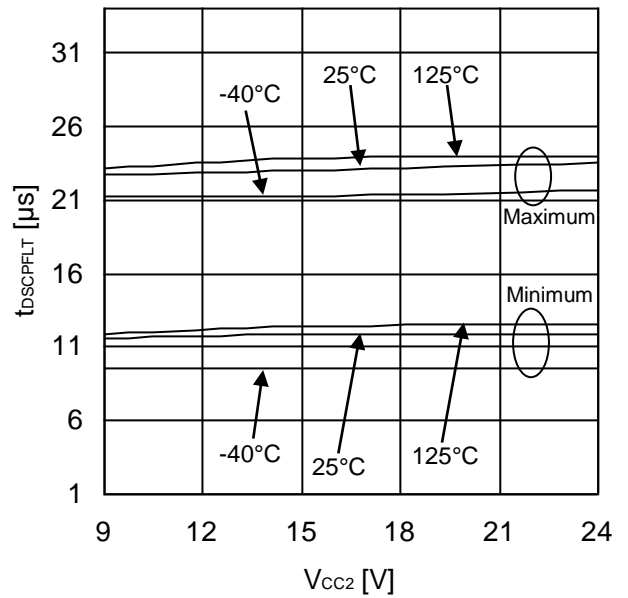

Figure 70. Short Current Detection Delay time (FLT)

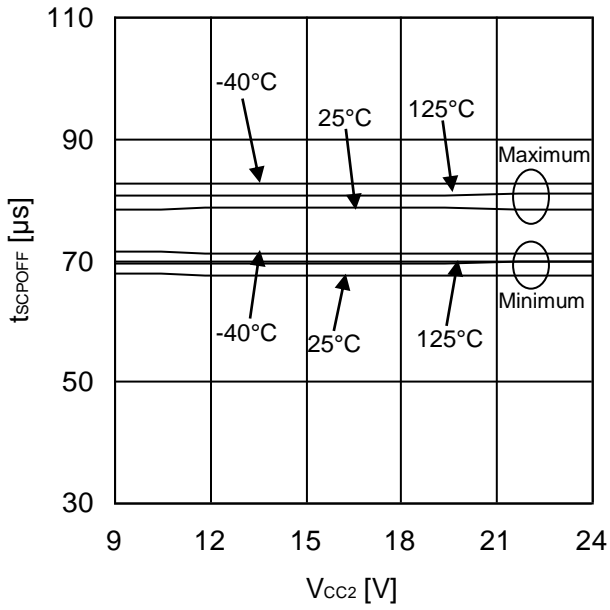

Figure 71. Soft Turn OFF Release Time

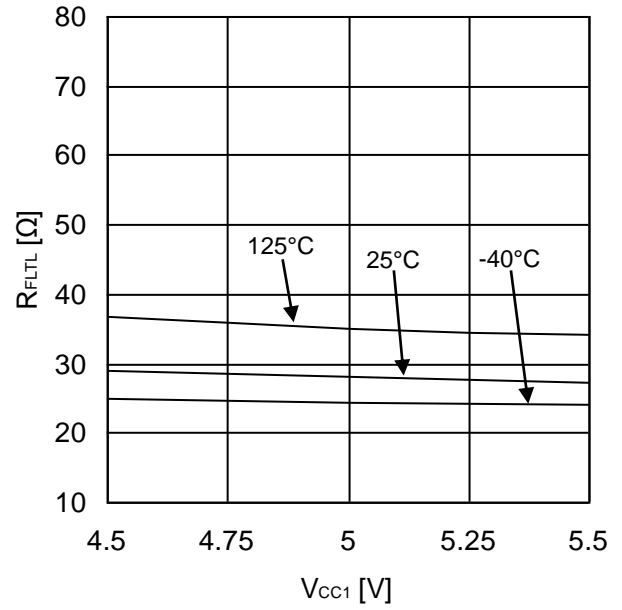

Figure 72. FLT Output ON-Resistance (IFLT=5mA)

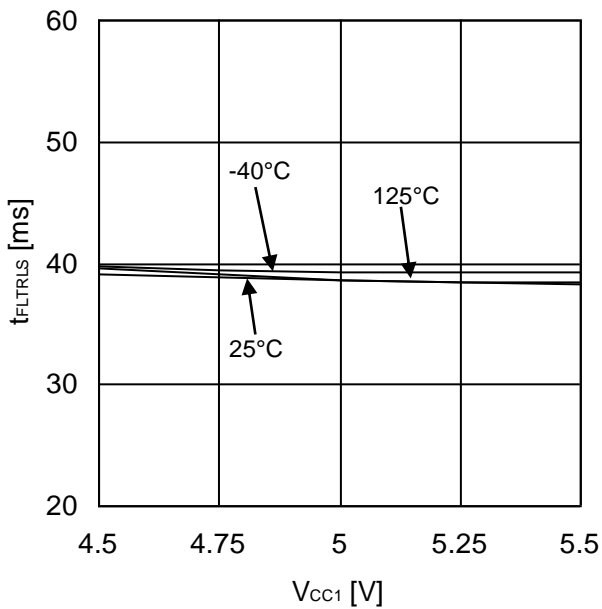

Figure 73. Fault Output Holding Time

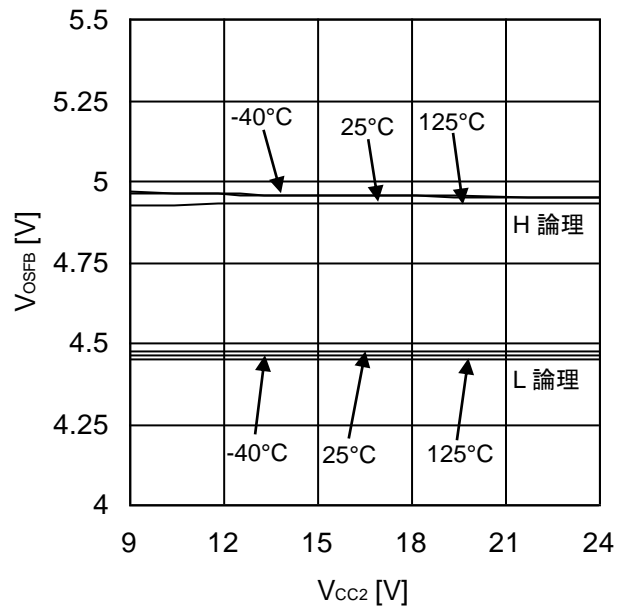

Figure 74. Gate State H/L Detection Threshold Voltage

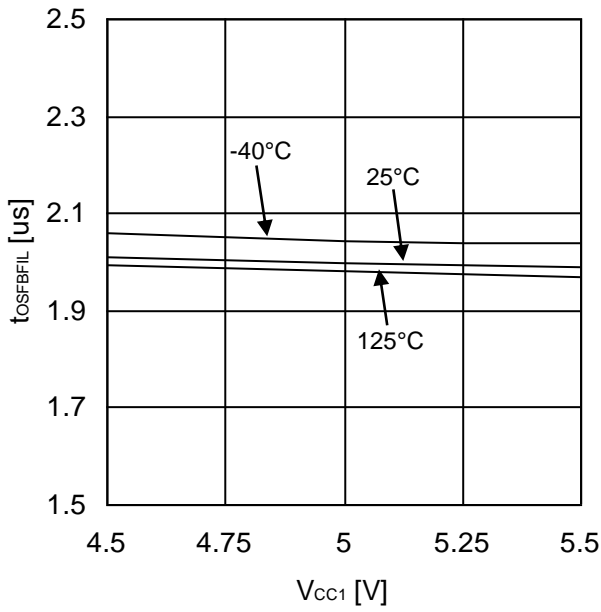

Figure 75. OSFB Output Filtering Time

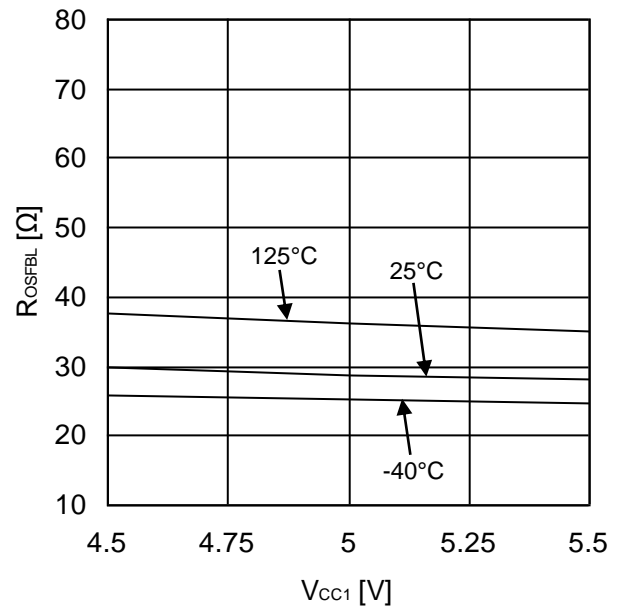

Figure 76. OSFB Output ON-Resistance ($I_{OSFB}=5mA$)

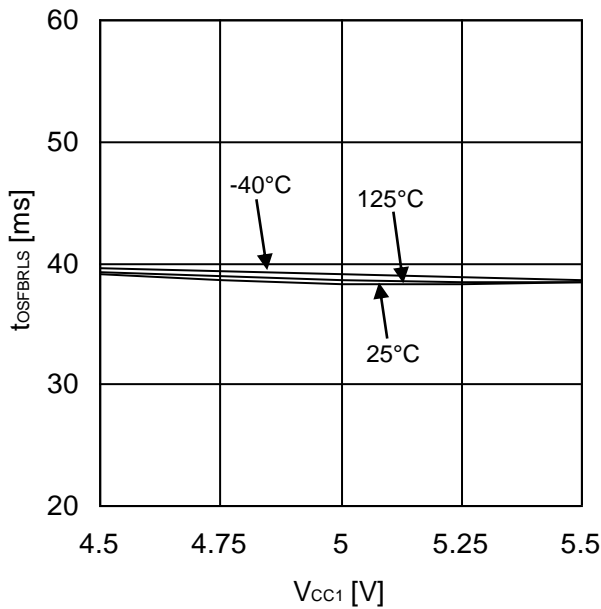

Figure 77. OSFB Output Holding Time

Description of Pins and Cautions on Layout of Board

1. V_BATT (Main power supply pin)
This is the main power supply pin. Connect a bypass capacitor between V_BATT and GND1 in order to suppress voltage variations. Be sure to apply a power supply even when the switching power supply is not used, since the internal reference voltage of the input side chip is generated from this power supply.
2. VCC1 (Input-side power supply pin)
The VCC1 pin is a power supply pin on the input side. To suppress voltage fluctuations due to the driving current of the internal transformer, connect a bypass capacitor between the VCC1 and the GND1 pins.
3. GND1 (Input-side ground pin)
The GND1 pin is a ground pin on the input side.
4. VCC2 (Output-side positive power supply pin)
The VCC2 pin is a positive power supply pin on the output side. To reduce voltage fluctuations due to the driving current of the internal transformer and output current, connect a bypass capacitor between the VCC2 and the GND2 pins.
5. GND2 (Output-side ground pin)
The GND2 pin is a ground pin on the output side. Connect the GND2 pin to the emitter / source of output device.
6. INA, DIS (Control input pin, input enabling signal input pin)
They are pins for deciding the output logic.

DIS	INA	OUT1
H	X	L
L	L	L
L	H	H

X: Don't care

7. FLT (Fault output pin)
The FLT pin is an open drain pin that outputs a fault signal when a fault occurs (i.e., when the under voltage lockout function (UVLO) or short circuit protection function (SCP) is activated).

State	FLT
While in normal operation	Hi-Z
When a Fault occurs (UVLO / SCP)	L

8. OSFB (Output pin for monitoring gate condition)
This is an open drain pin which compares gate logic of the output element monitored with PROOUT pin and DIS/INA pin input logic, and outputs L when they disaccord.

Status	DIS	INA	PROOUT(input)	OSFB
Normal operation	H	X	H	L
	H	X	L	Hi-Z
	L	L	H	L
	L	L	L	Hi-Z
	L	H	H	Hi-Z
Fault	X	X	X	L

X: Don't care

9. SENSOR (Temperature information output pin)
This is a pin which outputs the voltage of either TO1 or TO2, whichever is lower, converted to Duty cycle.
10. FB (Error amplifier inverting input pin for switching controller)
This is a voltage feedback pin of the switching controller. Connect it to VCC1 when the switching controller is not used.
11. COMP (Error amplifier output pin for switching controller)
This is the gain control pin of the switching controller. Connect a phase compensation capacitor and resistor. When the switching controller is not used, connect it to GND1.
12. VREG (Power supply pin for the driving MOS FET of the switching controller)
This is the power supply pin for the driving MOSFET of the switching controller transformer drive. Be sure to connect a capacitor between VREG and GND1 even when the switching controller is not used, in order to prevent oscillation and suppress voltage variation due to FET_G output current.

Description of Pins and Cautions on Layout of Board – continued

13. FET_G (MOS FET control pin for switching controller)
This is a MOSFET control pin for the switching controller transformer drive. Leave it unconnected when the switching controller is not used.
14. SENSE (Connection to the current feedback resistor of the switching controller)
This is a pin connected to the resistor of the switching controller current feedback. FET_G pin output duty is controlled by the voltage value of this pin. Connect it to VCC1 when switching controller is not used.
15. OUT(Output pin)
The OUT pin is a gate driving pin.
16. OUT2 (Miller clamp pin)
This is the miller clamp pin for preventing a rise of gate voltage due to miller current of output element connected to OUT1. OUT2 should be unconnected when miller clamp function is not used.
17. PROOUT (Soft turn-OFF pin)
This is a pin for soft turn-OFF of output pin when short-circuit protection is in action. It also functions as a pin for monitoring gate voltage for miller clamp function and output state feedback function.
18. SCPIN1, SCPIN2, SCPIN3 (Short circuit current detection pin)
These are the pins used to detect current for short circuit protection. When the SCPIN1 pin, SCPIN2 pin or SCPIN3 pin voltage exceeds the voltage set with the V_{SCDET} parameter, the SCP function will be activated, this will make the IC function in an open state. To avoid such trouble, connect a resistor between the SCPIN and the GND2 or short the SCPIN pin to GND2 when the SCP function is not used.
19. TC (Resistor connection pin for setting constant current source output)
The TC pin is a resistor connection pin for setting the constant current output. If an arbitrary resistance value is connected between TC and GND2, it is possible to set the constant current value output from TO.
20. TO1, TO2 (Constant current output / sensor voltage input pin)
The TO1 pin and the TO2 pin are constant current output / voltage input pins. It can be used as a sensor input by connecting an element with arbitrary impedance between TOx pin and GND. Furthermore, the TOx pin disconnect detection function is built-in.
21. UVLOIN (Output-side UVLO setting input pin)
The UVLOIN pin is a pin for deciding UVLO setting value of VCC2. The threshold value of UVLO can be set by dividing the resistance voltage of VCC2 and inputting such value.

Description of Functions and Examples of Constant Setting

1. Fault status output

This function is used to output a fault signal from the FLT pin when a fault occurs (i.e., when the under voltage lockout function (UVLO) or short circuit protection function (SCP) is activated) and hold the fault signal until fault output holding time (t_{FLTRLS}) is completed.

Status	FLT pin
Normal	Hi-Z
Fault occurs	L

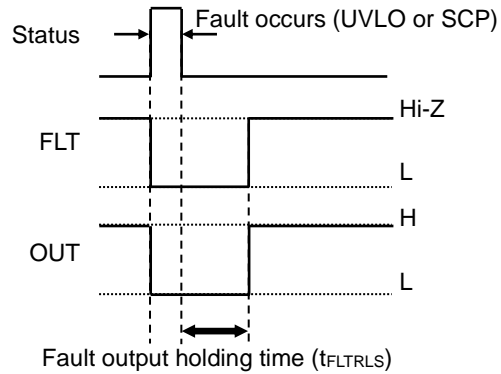

Figure 78. Fault Status Output Timing Chart

2. Under voltage Lockout (UVLO) function

The BM60051FV-C incorporates the under voltage lockout (UVLO) function on V_BATT, VCC1 and VCC2. When the power supply voltage drops to the UVLO ON voltage, the OUT pin and the FLT pin will both output the “L” signal. When the power supply voltage rises to the UVLO OFF voltage, these pins will be reset. However, during the fault output holding time set in “Fault status output” section, the OUT pin and the FLT pin will hold the “L” signal. In addition, to prevent mis-triggers due to noise, mask time $t_{UVLO1FIL}$ and $t_{UVLO2FIL}$ are set on both low and high sides.

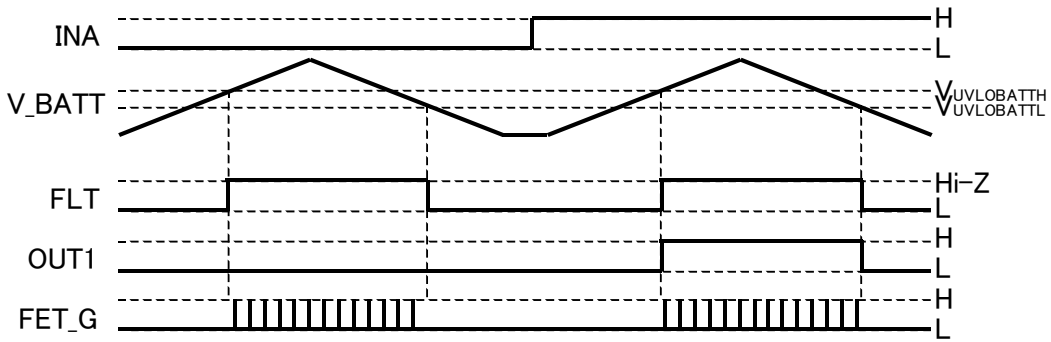

Figure 79. V_BATT UVLO Function Operation Timing Chart

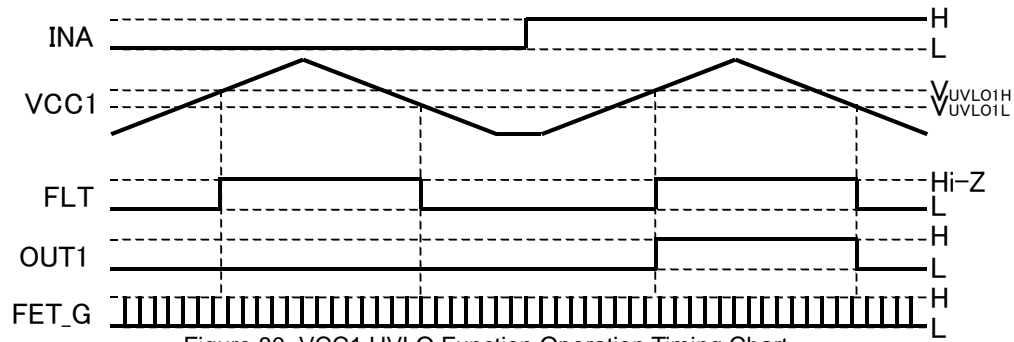

Figure 80. VCC1 UVLO Function Operation Timing Chart

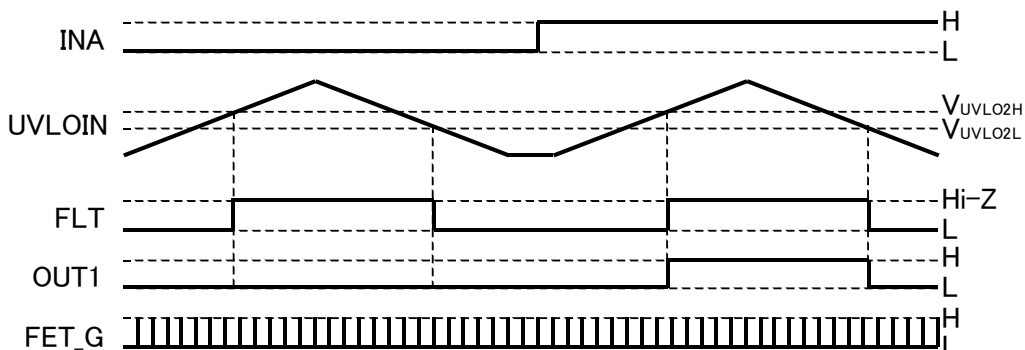

Figure 81. VCC2 UVLO Function Operation Timing Chart

Description of Functions and Examples of Constant Setting - continued

3. Short circuit protection (SCP) function

When the SCPIN pin voltage exceeds a voltage set with the V_{SCDET} parameter, the SCP function will be activated. When the SCP function is activated, the OUT pin voltage will be set to the "Hi-Z" level and the PROOUT pin voltage will go to the "L" level first (soft turn-OFF). Next, when the short-circuit current falls below the threshold value and after t_{SCPOFF} has passed, OUT pin and PROOUT pin become L. Finally, when the fault output holding time is completed, the SCP function will be released.

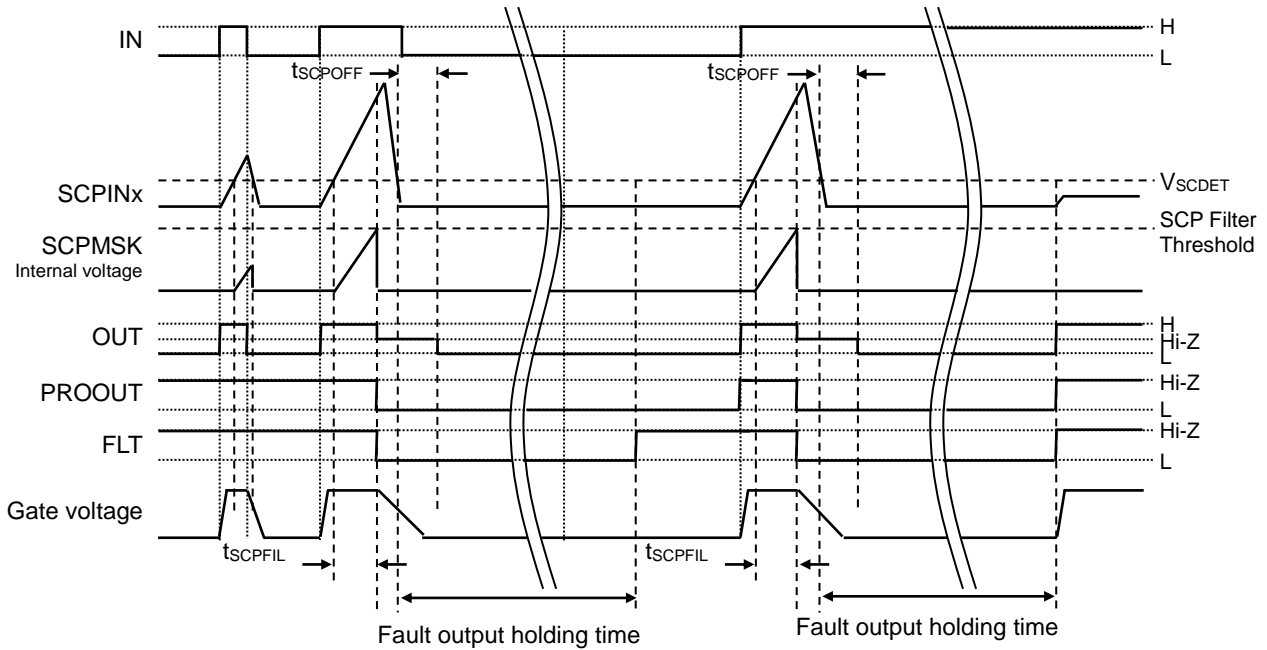

Figure 82. SCP Operation Timing Chart

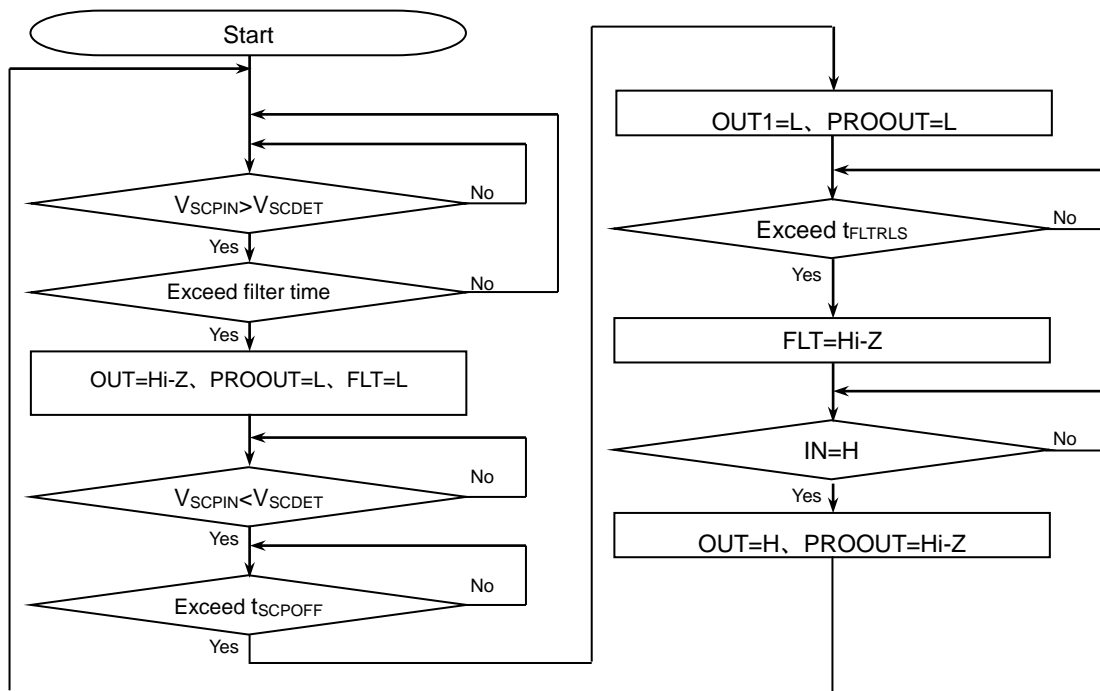

Figure 83. SCP Operation Status Transition Diagram

Description of Functions and Examples of Constant Setting - continued

4. Miller Clamp function

When $OUT1=L$ and $PROOUT$ pin voltage $< V_{OUT2ON}$, internal MOS of $OUT2$ pin is turned ON, and miller clamp function operates. While the short-circuit protection function is activated, miller clamp function operates after lapse of soft turn-OFF release time t_{SCPOFF} .

Short current	SCPIN	INA	PROOUT	OUT2
Detected	Not less than V_{SCDET}	X	X	Hi-Z
Not detected	X	L	Not less than V_{OUT2ON}	Hi-Z
	X	L	Not more than V_{OUT2ON}	L
	X	H	X	Hi-Z

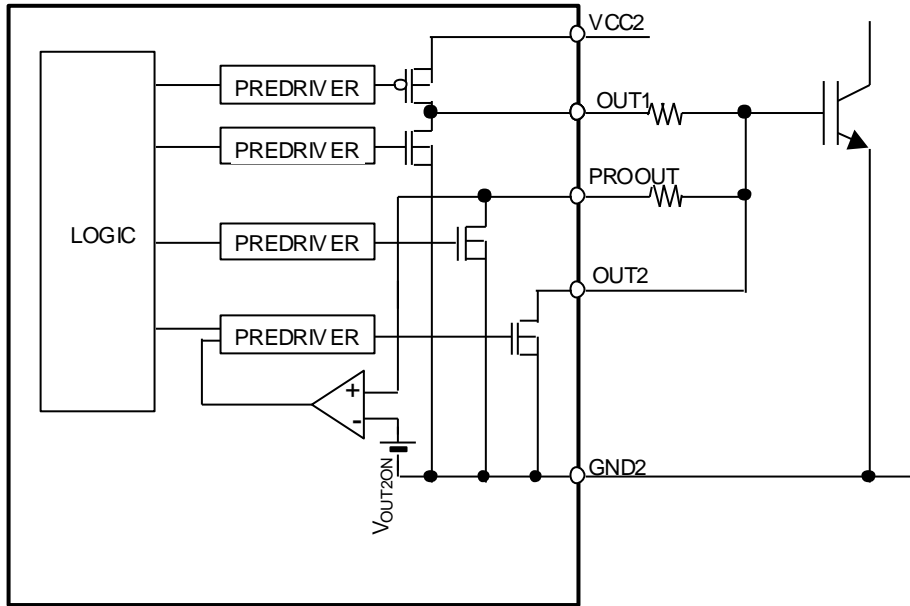

Figure 84. Block Diagram of Miller Clamp Function

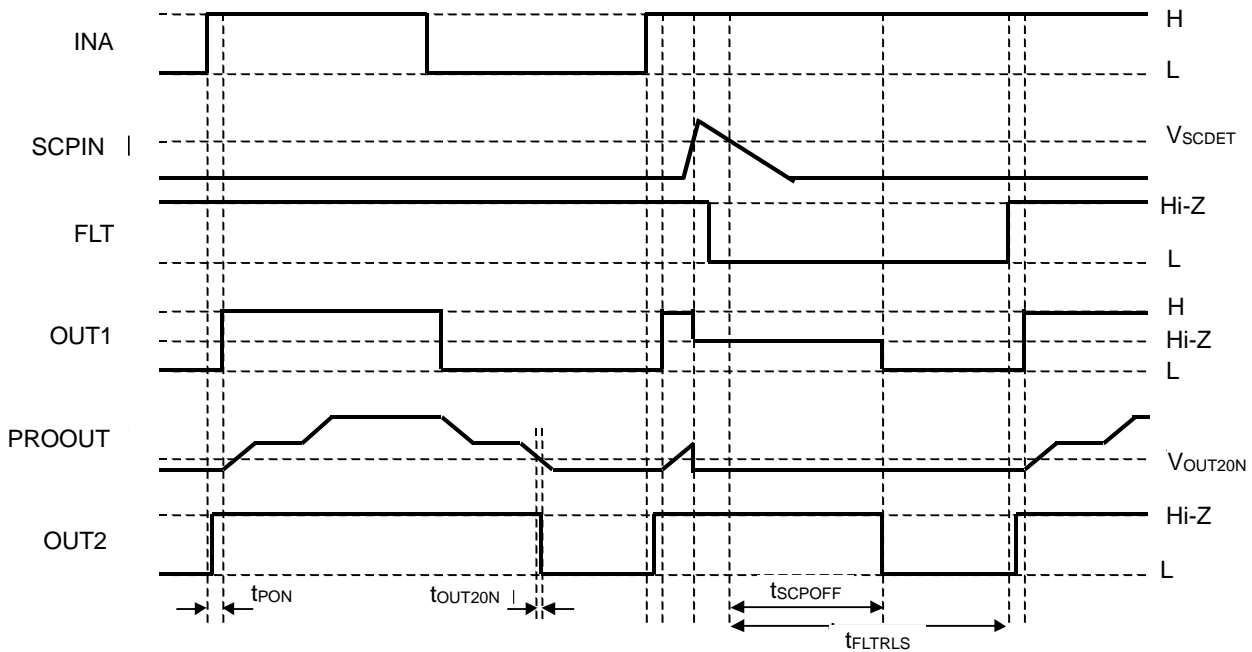

Figure 85. Timing chart of Miller Clamp Function

Description of Functions and Examples of Constant Setting - continued

5. Temperature monitor function

Constant current is supplied from TOx pins from the built-in constant current circuit. This current value can be adjusted in accordance with the resistance value connected between TC and GND2. Furthermore, TOx pin has voltage input function, and outputs signal of TOx pin voltage converted to Duty from SENSOR pin. When voltage of either one of TOx pins is no less than disconnect detection voltage V_{TOH} , SENSOR pin outputs L. Therefore, when only one of the TOx pins is used, connect a resistor between the other TO pins and GND2 to keep pin voltage at no more than V_{TOH} .

$$\text{Constant current value} = \frac{V_{TC} \times 10}{R_{TC}}$$

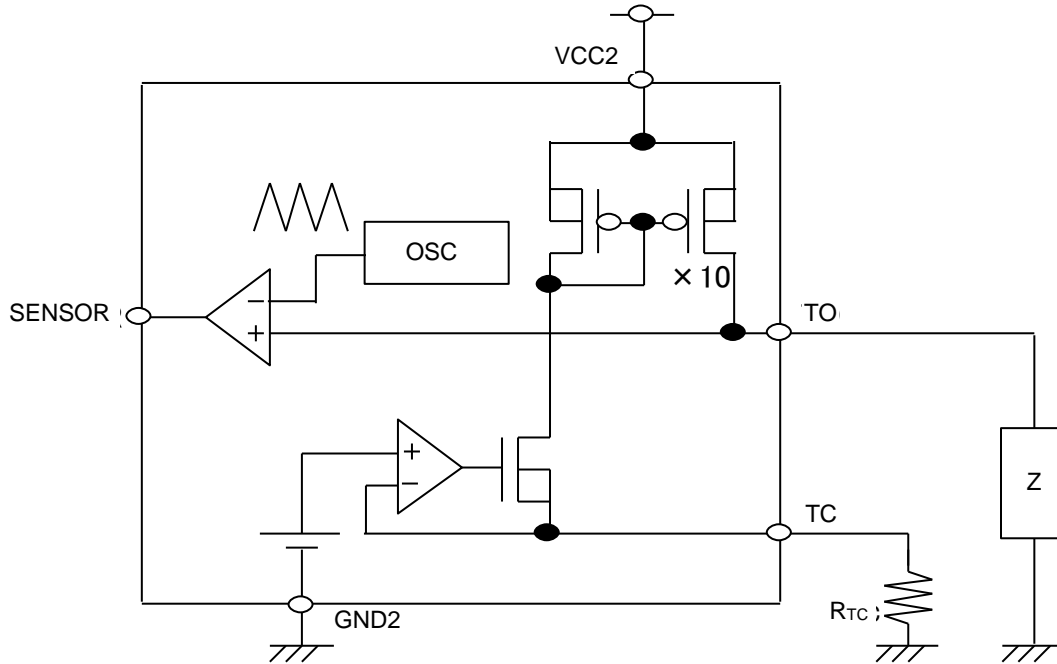
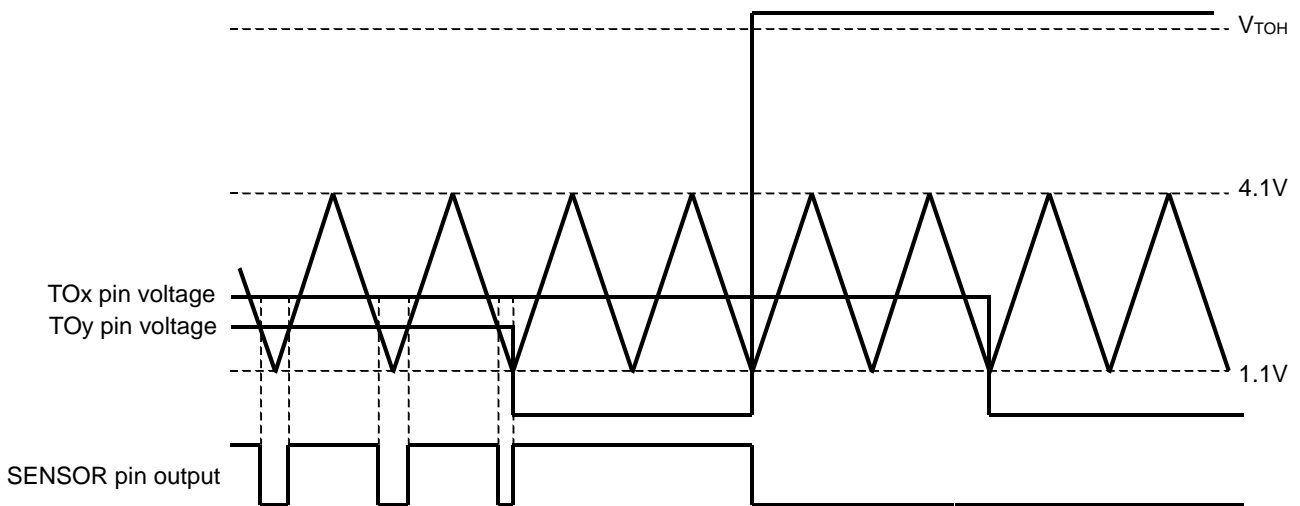

Figure 86. Block Diagram of Temperature Monitor Function



When voltage is no more than V_{TOH} , either one of TO1 and TO2 terminals with lower voltage has precedence.

Figure 87. Timing Chart of Temperature Monitor Function

Description of Functions and Examples of Constant Setting - continued

6. Switching regulator

(1) Basic action

This IC has a built-in switching power supply controller which repeats ON/OFF synchronizing with internal clock. When VBATT voltage is supplied ($V_{BATT} > V_{UVLOBATT}$), FTE_G pin starts switching by soft-start. Output voltage is determined by the following equation by external resistance and winding ratio "n" of flyback transformer (n= V_{OUT2} side winding number/ V_{OUT1} side winding number)

$$V_{OUT2} = V_{FB} \times \left\{ (R_1 + R_2) / R_2 \right\} \times n [V]$$

(2) MAX DUTY

When, for example, output load is large, and voltage level of SENSE pin does not reach current detection level, output is forcibly turned OFF by Maximum On Duty (D_{ONMAX}).

(3) Pin conditions when the switching power supply controller is not used

Implement pin treatment as shown below when switching power supply is not used.

Pin Number	Pin Name	Treatment Method
22	FB	Connect to VCC1
23	COMP	Connect to GND1
24	V_BATT	Connect power supply
25	VREG	Connect capacitor
26	FET_G	No connection
27	SENSE	Connect to VCC1

7. Gate state monitoring function

When gate logic and input logic of output device monitored with PROOUT pin are compared, a logic L is output from OSFB pin when they disaccord. In order to prevent the detection error due to delay of input and output, OSFB filter time t_{OSFBON} is provided.

Description of Functions and Examples of Constant Setting - continued

8. I/O condition table

No.	Status	Input							Output				
		VCC1	UVLOIN	VBATT	SC P I N X	DIS	INA	PRO O U T	OUT 1	OUT 2	PRO O U T	FLT	OS F B
1	SCP	○	H	○	H	L	H	X	Z	Z	L	L	Z
2	VCC1UVLO	UVLO	X	X	L	X	X	H	L	Z	Z	L	Z
3		UVLO	X	X	L	X	X	L	L	L	Z	L	Z
4	VCC2UVLO	X	L	X	L	X	X	H	L	Z	Z	L	Z
5		X	L	X	L	X	X	L	L	L	Z	L	Z
6	VBATT1UVLO	X	X	UVLO	L	X	X	H	L	Z	Z	L	Z
7		X	X	UVLO	L	X	X	L	L	L	Z	L	Z
8	Disable	○	H	○	L	H	X	H	L	Z	Z	Z	L
9		○	H	○	L	H	X	L	L	L	Z	Z	Z
10	Normal Operation L Input	○	H	○	L	L	L	H	L	Z	Z	Z	L
11		○	H	○	L	L	L	L	L	L	Z	Z	Z
12	Normal Operation H Input	○	H	○	L	L	H	H	H	Z	Z	Z	Z
13		○	H	○	L	L	H	L	H	Z	Z	Z	L

○: VCC1 > UVLO, X: Don't care, Z: Hi-Z

Description of Functions and Examples of Constant Setting - continued

9. Power supply startup / shutoff sequence

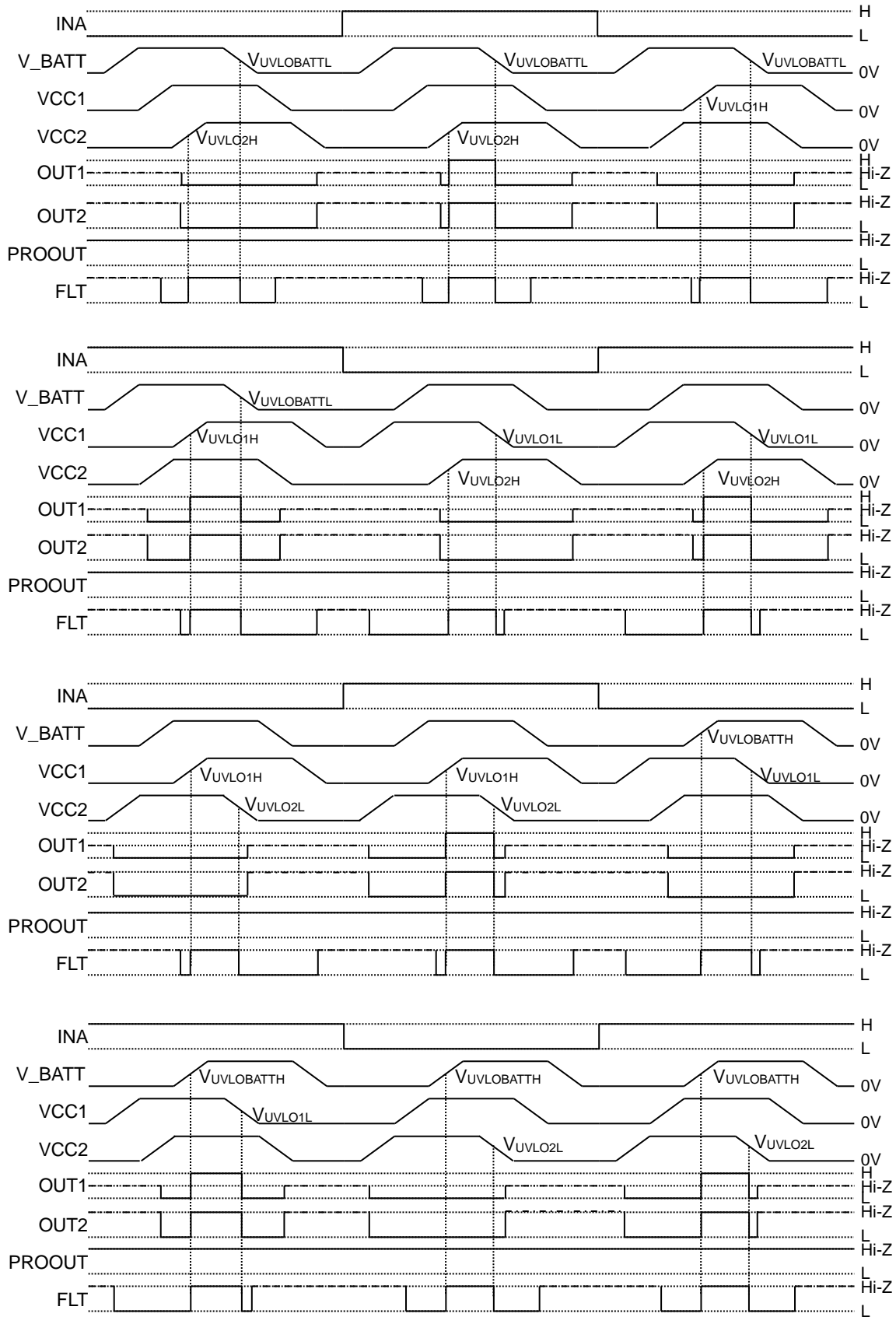

----- : Since the VCC2 to GND2 pin voltage is low and the output MOS does not turn ON, the output pins become Hi-Z conditions.
 ----- : Since the VCC1 pin voltage is low and the FLT output MOS does not turn ON, the output pins become Hi-Z conditions.

Figure 88. Power Supply Startup / Shutoff Sequence

Selection of Components Externally Connected

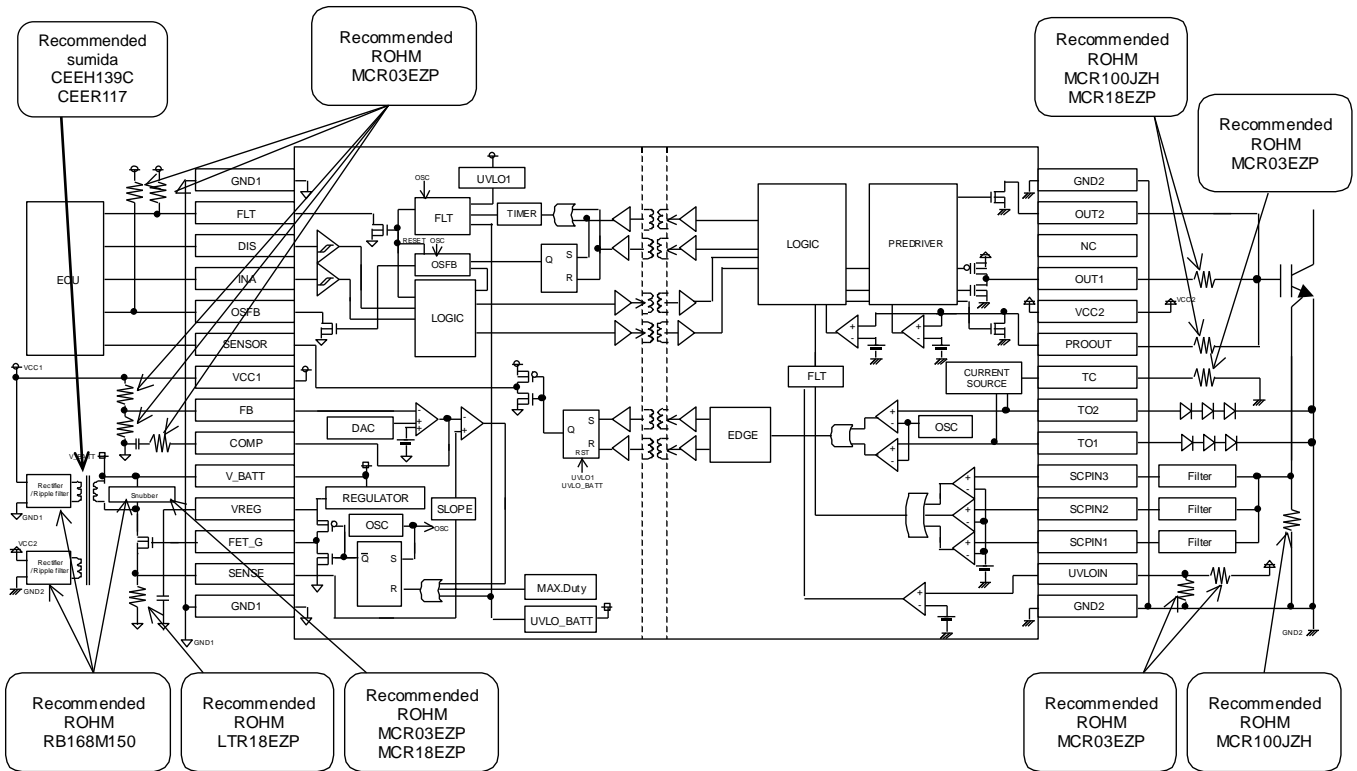

Figure 89. For using switching power supply controller

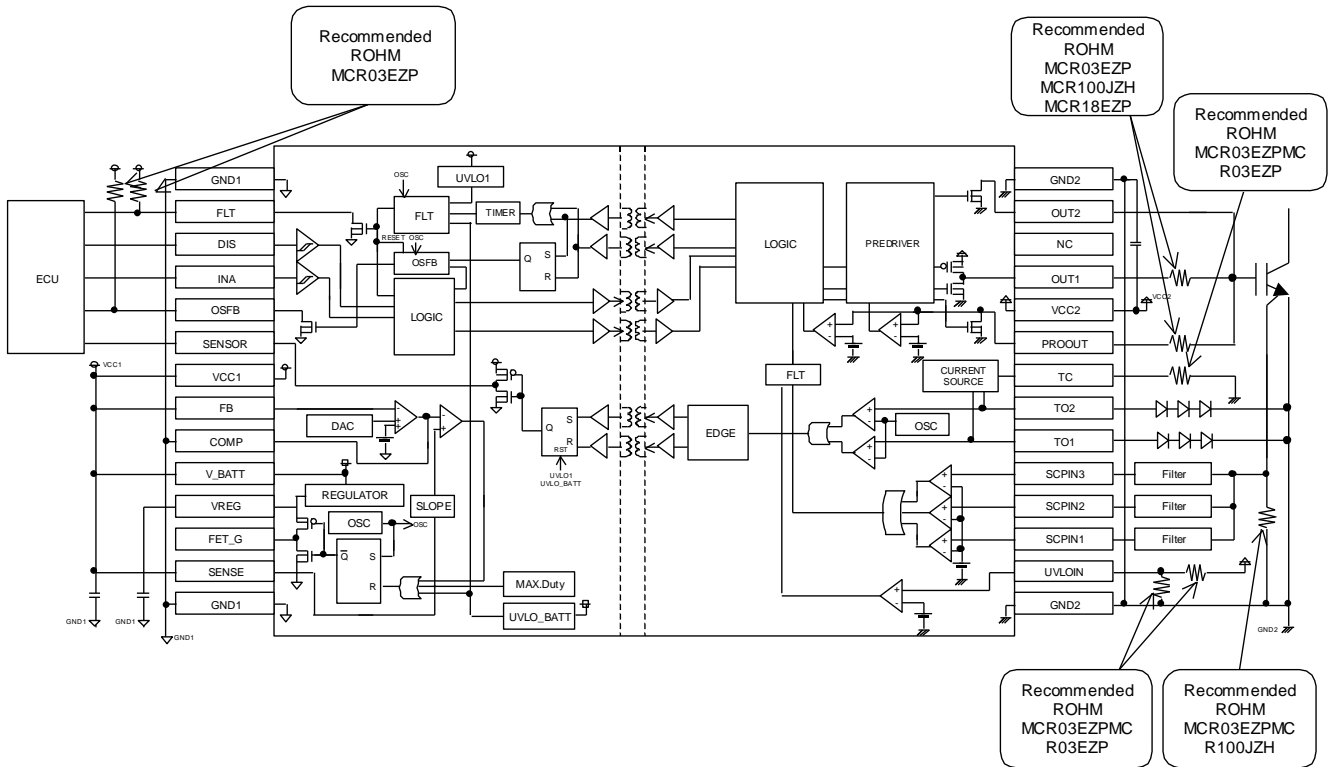

Figure 90. For no using switching power supply controller

Power Dissipation

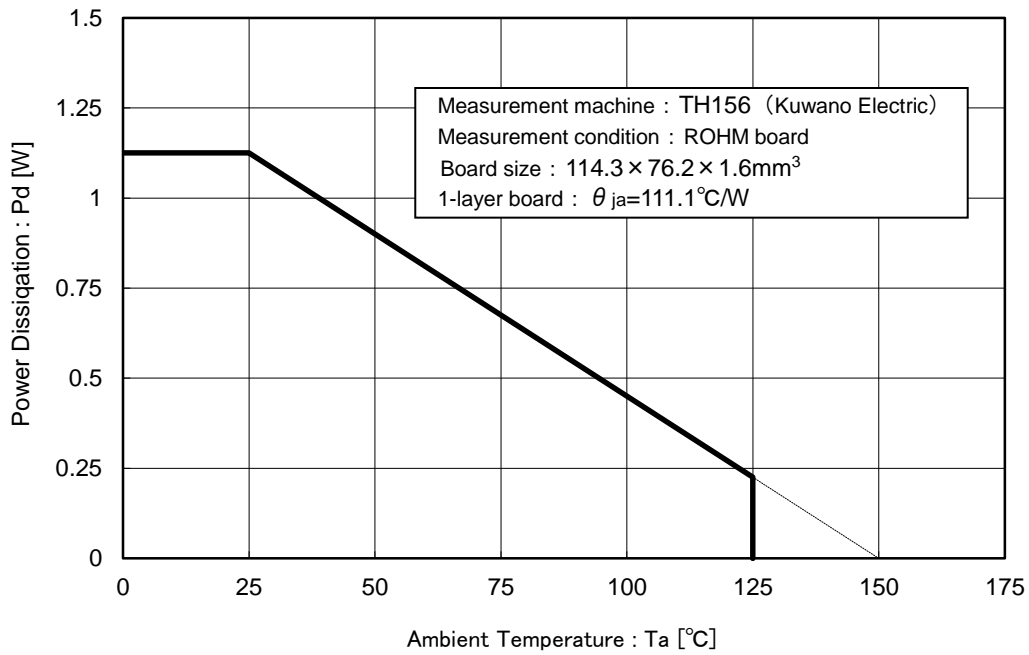

Figure 91. SSOP-B28W Power Dissipation Curve (Pd-Ta Curve)

Thermal Design

Please make sure that the IC's chip temperature T_j is not over 150°C, while considering the IC's power consumption (W), package power (Pd) and ambient temperature (Ta). When $T_j=150^\circ\text{C}$ is exceeded, the IC may malfunction or some problems (ex. abnormal operation of various parasitic elements and increasing of leak current) may occur. Constant use under these circumstances leads to deterioration and eventually IC may destruct. $T_{j\text{max}}=150^\circ\text{C}$ must be strictly obeyed under all circumstances.

I/O Equivalent Circuit

Pin No.	Pin Name	Input Output Equivalent Circuit Diagram
	Pin Function	
2	UVLOIN	
	Output-side UVLO setting pin	
3	SCPIN1	
4	SCPIN2	
	SCPIN3	
5	Short circuit current detection pin 3	
6	TO1	
	Constant current output pin / sensor voltage input pin 1	
7	TO2	
	Constant current output pin / sensor voltage input pin 2	
8	TC	
	Constant current setting resistor connection pin	

I/O Equivalent Circuit - continued

Pin No.	Pin Name	Input Output Equivalent Circuit Diagram
	Pin Function	
11	OUT1	
	Output pin	
9	PROOUT	
	Soft turn-OFF pin /Gate voltage input pin	
13	OUT2	
	Output pin for Miller Clamp	
16	FLT	
	Fault output pin	
19	OSFB	
	Output state feedback output pin	
20	SENSOR	
	Temperature information output pin	

I/O Equivalent Circuit - continued

Pin No.	Pin Name	Input Output Equivalent Circuit Diagram
	Pin Function	
17	DIS	
	Input enabling signal input pin	
18	INA	
	Control input pin	
22	FB	
	Error amplifier inverting input pin for switching controller	
23	COMP	
	Error amplifier output pin for switching controller	

I/O Equivalent Circuit - continued

Pin No.	Pin Name	Input Output Equivalent Circuit Diagram
	Pin Function	
25	VREG	
	Power supply pin for driving MOS FET of switching controller	
26	FET_G	
	MOS FET control pin for switching controller	
27	SENSE	
	Current feedback resistor connection pin for switching controller	

Operational Notes

1. Reverse Connection of Power Supply

Connecting the power supply in reverse polarity can damage the IC. Take precautions against reverse polarity when connecting the power supply, such as mounting an external diode between the power supply and the IC's power supply terminals.

2. Power Supply Lines

Design the PCB layout pattern to provide low impedance supply lines. Separate the ground and supply lines of the digital and analog blocks to prevent noise in the ground and supply lines of the digital block from affecting the analog block. Furthermore, connect a capacitor to ground at all power supply pins. Consider the effect of temperature and aging on the capacitance value when using electrolytic capacitors.

3. Ground Voltage

Ensure that no pins are at a voltage below that of the ground pin at any time, even during transient condition.

4. Ground Wiring Pattern

When using both small-signal and large-current ground traces, the two ground traces should be routed separately but connected to a single ground at the reference point of the application board to avoid fluctuations in the small-signal ground caused by large currents. Also ensure that the ground traces of external components do not cause variations on the ground voltage. The ground lines must be as short and thick as possible to reduce line impedance.

5. Thermal Consideration

Should by any chance the power dissipation rating be exceeded the rise in temperature of the chip may result in deterioration of the properties of the chip. The absolute maximum rating of the Pd stated in this specification is when the IC is mounted on a 70mm x 70mm x 1.6mm glass epoxy board. In case of exceeding this absolute maximum rating, increase the board size and copper area to prevent exceeding the Pd rating.

6. Recommended Operating Conditions

These conditions represent a range within which the expected characteristics of the IC can be approximately obtained. The electrical characteristics are guaranteed under the conditions of each parameter.

7. Rush Current

When power is first supplied to the IC, it is possible that the internal logic may be unstable and inrush current may flow instantaneously due to the internal powering sequence and delays, especially if the IC has more than one power supply. Therefore, give special consideration to power coupling capacitance, power wiring, width of ground wiring, and routing of connections.

8. Operation Under Strong Electromagnetic Field

Operating the IC in the presence of a strong electromagnetic field may cause the IC to malfunction.

9. Testing on Application Boards

When testing the IC on an application board, connecting a capacitor directly to a low-impedance output pin may subject the IC to stress. Always discharge capacitors completely after each process or step. The IC's power supply should always be turned off completely before connecting or removing it from the test setup during the inspection process. To prevent damage from static discharge, ground the IC during assembly and use similar precautions during transport and storage.

10. Inter-pin Short and Mounting Errors

Ensure that the direction and position are correct when mounting the IC on the PCB. Incorrect mounting may result in damaging the IC. Avoid nearby pins being shorted to each other especially to ground, power supply and output pin. Inter-pin shorts could be due to many reasons such as metal particles, water droplets (in very humid environment) and unintentional solder bridge deposited in between pins during assembly to name a few.

Operational Notes – continued

11. Unused Input Terminals

Input terminals of an IC are often connected to the gate of a MOS transistor. The gate has extremely high impedance and extremely low capacitance. If left unconnected, the electric field from the outside can easily charge it. The small charge acquired in this way is enough to produce a significant effect on the conduction through the transistor and cause unexpected operation of the IC. So unless otherwise specified, unused input terminals should be connected to the power supply or ground line.

12. Regarding the Input Pin of the IC

This monolithic IC contains P+ isolation and P substrate layers between adjacent elements in order to keep them isolated. P-N junctions are formed at the intersection of the P layers with the N layers of other elements, creating a parasitic diode or transistor. For example (refer to figure below):

- When GND > Pin A and GND > Pin B, the P-N junction operates as a parasitic diode.
- When GND > Pin B, the P-N junction operates as a parasitic transistor.

Parasitic diodes inevitably occur in the structure of the IC. The operation of parasitic diodes can result in mutual interference among circuits, operational faults, or physical damage. Therefore, conditions that cause these diodes to operate, such as applying a voltage lower than the GND voltage to an input pin (and thus to the P substrate) should be avoided.

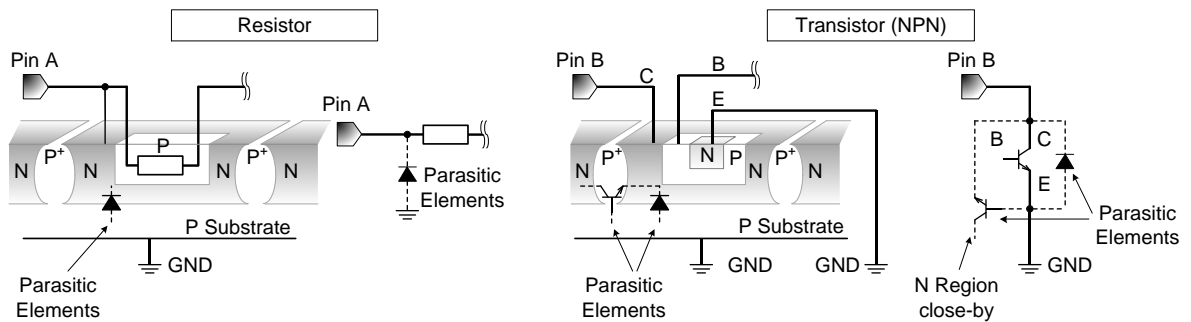
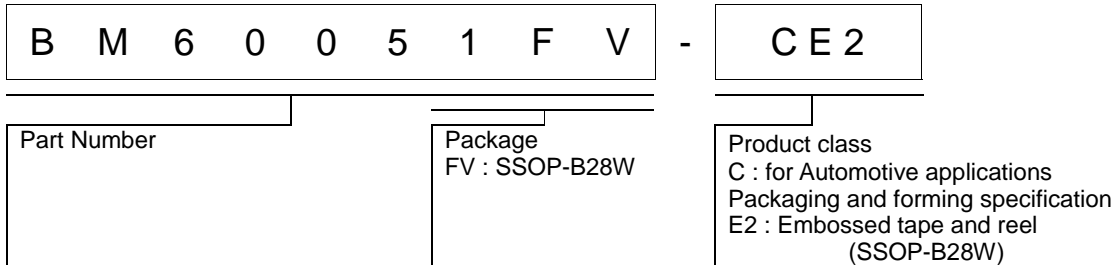

Figure 24. Example of monolithic IC structure

13. Ceramic Capacitor

When using a ceramic capacitor, determine the dielectric constant considering the change of capacitance with temperature and the decrease in nominal capacitance due to DC bias and others.

Ordering Information



Marking Diagram

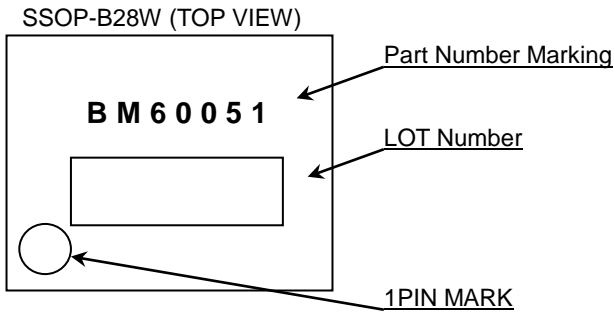

Physical Dimension, Tape and Reel Information

Package Name	SSOP-B28W
--------------	-----------

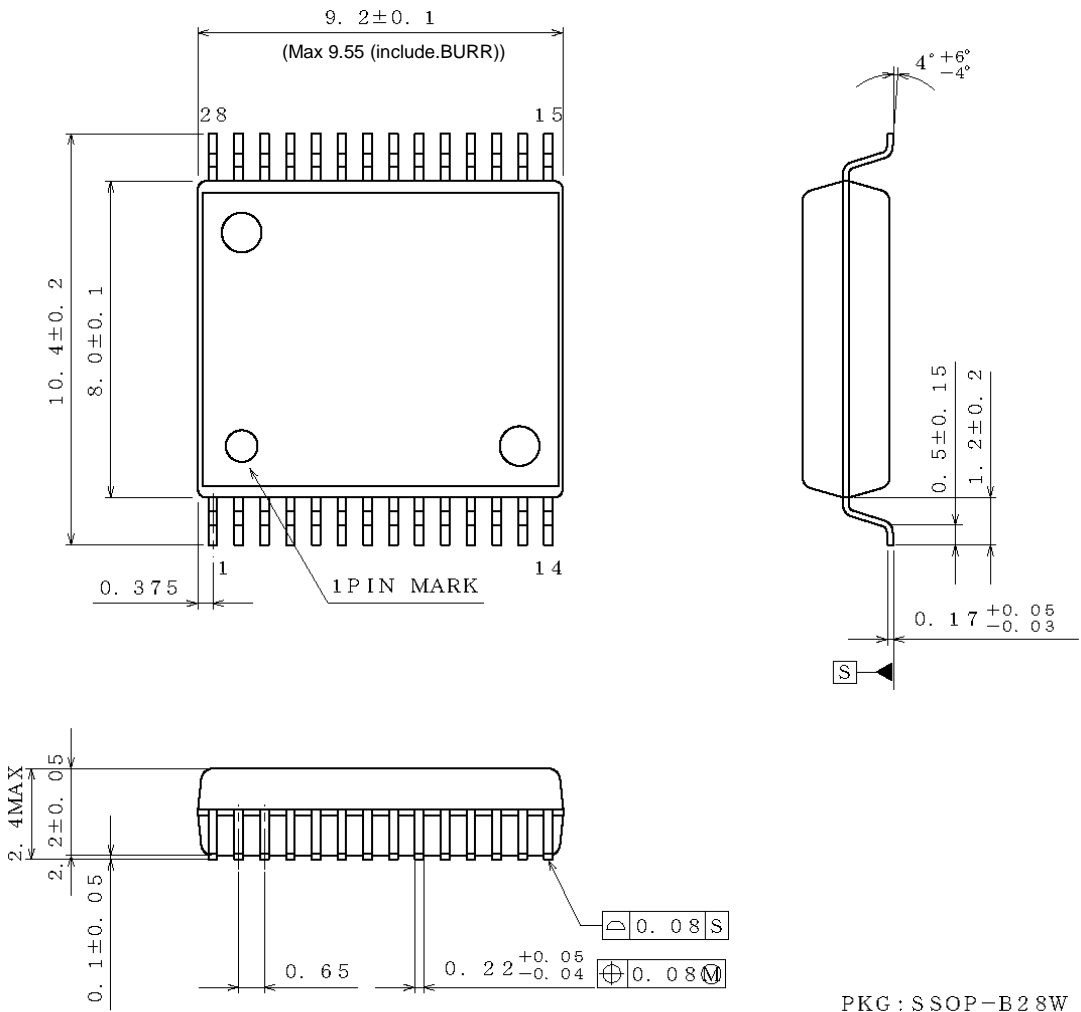

PKG : SSOP-B28W
 Drawing No. ; EX072-5001

(UNIT : mm)

< Tape and Reel Information >

Tape	Embossed carrier tape
Quantity	1500pcs
Direction of feed	E2 The direction is the pin 1 of product is at the upper left when you hold reel on the left hand and you pull out the tape on the right hand

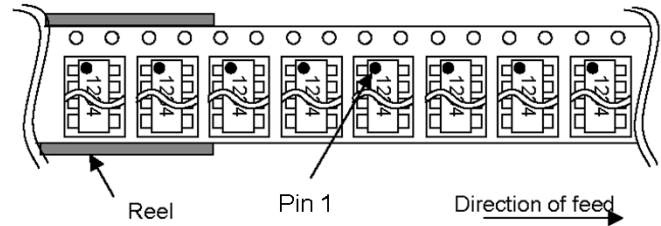

Revision History

Date	Revision	Changes
25.Apr.2014	001	New Release
13.May.2015	002	P.1 Features Adding item (UL1577 Recognized) P.21,22 Typical Performance Curves Correcting mistakes
25.Dec.2015	003	P.9 Adding UL1577 Rating Table

Notice

Precaution on using ROHM Products

1. If you intend to use our Products in devices requiring extremely high reliability (such as medical equipment ^(Note 1), aircraft/spacecraft, nuclear power controllers, etc.) and whose malfunction or failure may cause loss of human life, bodily injury or serious damage to property ("Specific Applications"), please consult with the ROHM sales representative in advance. Unless otherwise agreed in writing by ROHM in advance, ROHM shall not be in any way responsible or liable for any damages, expenses or losses incurred by you or third parties arising from the use of any ROHM's Products for Specific Applications.

(Note1) Medical Equipment Classification of the Specific Applications

JAPAN	USA	EU	CHINA
CLASS III	CLASS III	CLASS II b	CLASS III
CLASS IV		CLASS III	

2. ROHM designs and manufactures its Products subject to strict quality control system. However, semiconductor products can fail or malfunction at a certain rate. Please be sure to implement, at your own responsibilities, adequate safety measures including but not limited to fail-safe design against the physical injury, damage to any property, which a failure or malfunction of our Products may cause. The following are examples of safety measures:
 - [a] Installation of protection circuits or other protective devices to improve system safety
 - [b] Installation of redundant circuits to reduce the impact of single or multiple circuit failure
3. Our Products are not designed under any special or extraordinary environments or conditions, as exemplified below. Accordingly, ROHM shall not be in any way responsible or liable for any damages, expenses or losses arising from the use of any ROHM's Products under any special or extraordinary environments or conditions. If you intend to use our Products under any special or extraordinary environments or conditions (as exemplified below), your independent verification and confirmation of product performance, reliability, etc. prior to use, must be necessary:
 - [a] Use of our Products in any types of liquid, including water, oils, chemicals, and organic solvents
 - [b] Use of our Products outdoors or in places where the Products are exposed to direct sunlight or dust
 - [c] Use of our Products in places where the Products are exposed to sea wind or corrosive gases, including Cl₂, H₂S, NH₃, SO₂, and NO₂
 - [d] Use of our Products in places where the Products are exposed to static electricity or electromagnetic waves
 - [e] Use of our Products in proximity to heat-producing components, plastic cords, or other flammable items
 - [f] Sealing or coating our Products with resin or other coating materials
 - [g] Use of our Products without cleaning residue of flux (even if you use no-clean type fluxes, cleaning residue of flux is recommended); or Washing our Products by using water or water-soluble cleaning agents for cleaning residue after soldering
 - [h] Use of the Products in places subject to dew condensation
4. The Products are not subject to radiation-proof design.
5. Please verify and confirm characteristics of the final or mounted products in using the Products.
6. In particular, if a transient load (a large amount of load applied in a short period of time, such as pulse. is applied, confirmation of performance characteristics after on-board mounting is strongly recommended. Avoid applying power exceeding normal rated power; exceeding the power rating under steady-state loading condition may negatively affect product performance and reliability.
7. De-rate Power Dissipation depending on ambient temperature. When used in sealed area, confirm that it is the use in the range that does not exceed the maximum junction temperature.
8. Confirm that operation temperature is within the specified range described in the product specification.
9. ROHM shall not be in any way responsible or liable for failure induced under deviant condition from what is defined in this document.

Precaution for Mounting / Circuit board design

1. When a highly active halogenous (chlorine, bromine, etc.) flux is used, the residue of flux may negatively affect product performance and reliability.
2. In principle, the reflow soldering method must be used on a surface-mount products, the flow soldering method must be used on a through hole mount products. If the flow soldering method is preferred on a surface-mount products, please consult with the ROHM representative in advance.

For details, please refer to ROHM Mounting specification

Precautions Regarding Application Examples and External Circuits

1. If change is made to the constant of an external circuit, please allow a sufficient margin considering variations of the characteristics of the Products and external components, including transient characteristics, as well as static characteristics.
2. You agree that application notes, reference designs, and associated data and information contained in this document are presented only as guidance for Products use. Therefore, in case you use such information, you are solely responsible for it and you must exercise your own independent verification and judgment in the use of such information contained in this document. ROHM shall not be in any way responsible or liable for any damages, expenses or losses incurred by you or third parties arising from the use of such information.

Precaution for Electrostatic

This Product is electrostatic sensitive product, which may be damaged due to electrostatic discharge. Please take proper caution in your manufacturing process and storage so that voltage exceeding the Products maximum rating will not be applied to Products. Please take special care under dry condition (e.g. Grounding of human body / equipment / solder iron, isolation from charged objects, setting of Ionizer, friction prevention and temperature / humidity control).

Precaution for Storage / Transportation

1. Product performance and soldered connections may deteriorate if the Products are stored in the places where:
 - [a] the Products are exposed to sea winds or corrosive gases, including Cl₂, H₂S, NH₃, SO₂, and NO₂
 - [b] the temperature or humidity exceeds those recommended by ROHM
 - [c] the Products are exposed to direct sunshine or condensation
 - [d] the Products are exposed to high Electrostatic
2. Even under ROHM recommended storage condition, solderability of products out of recommended storage time period may be degraded. It is strongly recommended to confirm solderability before using Products of which storage time is exceeding the recommended storage time period.
3. Store / transport cartons in the correct direction, which is indicated on a carton with a symbol. Otherwise bent leads may occur due to excessive stress applied when dropping of a carton.
4. Use Products within the specified time after opening a humidity barrier bag. Baking is required before using Products of which storage time is exceeding the recommended storage time period.

Precaution for Product Label

A two-dimensional barcode printed on ROHM Products label is for ROHM's internal use only.

Precaution for Disposition

When disposing Products please dispose them properly using an authorized industry waste company.

Precaution for Foreign Exchange and Foreign Trade act

Since concerned goods might be fallen under listed items of export control prescribed by Foreign exchange and Foreign trade act, please consult with ROHM in case of export.

Precaution Regarding Intellectual Property Rights

1. All information and data including but not limited to application example contained in this document is for reference only. ROHM does not warrant that foregoing information or data will not infringe any intellectual property rights or any other rights of any third party regarding such information or data.
2. ROHM shall not have any obligations where the claims, actions or demands arising from the combination of the Products with other articles such as components, circuits, systems or external equipment (including software).
3. No license, expressly or implied, is granted hereby under any intellectual property rights or other rights of ROHM or any third parties with respect to the Products or the information contained in this document. Provided, however, that ROHM will not assert its intellectual property rights or other rights against you or your customers to the extent necessary to manufacture or sell products containing the Products, subject to the terms and conditions herein.

Other Precaution

1. This document may not be reprinted or reproduced, in whole or in part, without prior written consent of ROHM.
2. The Products may not be disassembled, converted, modified, reproduced or otherwise changed without prior written consent of ROHM.
3. In no event shall you use in any way whatsoever the Products and the related technical information contained in the Products or this document for any military purposes, including but not limited to, the development of mass-destruction weapons.
4. The proper names of companies or products described in this document are trademarks or registered trademarks of ROHM, its affiliated companies or third parties.

General Precaution

1. Before you use our Products, you are requested to carefully read this document and fully understand its contents. ROHM shall not be in any way responsible or liable for failure, malfunction or accident arising from the use of any ROHM's Products against warning, caution or note contained in this document.
2. All information contained in this document is current as of the issuing date and subject to change without any prior notice. Before purchasing or using ROHM's Products, please confirm the latest information with a ROHM sales representative.
3. The information contained in this document is provided on an "as is" basis and ROHM does not warrant that all information contained in this document is accurate and/or error-free. ROHM shall not be in any way responsible or liable for any damages, expenses or losses incurred by you or third parties resulting from inaccuracy or errors of or concerning such information.

X-ON Electronics

Largest Supplier of Electrical and Electronic Components

Click to view similar products for [Gate Drivers](#) category:

Click to view products by [ROHM](#) manufacturer:

Other Similar products are found below :

[00028](#) [00053P0231](#) [8967380000](#) [56956](#) [CR7E-30DB-3.96E\(72\)](#) [57.404.7355.5](#) [LT4936](#) [57.904.0755.0](#) [5801-0903](#) [5803-0901](#) [5811-0902](#)
[5813-0901](#) [58410](#) [00576P0030](#) [00581P0070](#) [5882900001](#) [00103P0020](#) [00600P0005](#) [00-9050-LRPP](#) [00-9090-RDPP](#) [5951900000](#) [01-](#)
[1003W-10/32-15](#) [LTI LA6E-1S-WH-RC-FN12VXCR1](#) [0131700000](#) [00-2240](#) [LTP70N06](#) [LVP640](#) [0158-624-00](#) [5J0-1000LG-SIL](#) [020017-13](#)
[LY1D-2-5S-AC120](#) [LY2-0-US-AC120](#) [LY2-US-AC240](#) [LY3-UA-DC24](#) [00-5150](#) [00576P0020](#) [00600P0010](#) [LZNQ2M-US-DC5](#) [LZNQ2-](#)
[US-DC12](#) [LZP40N10](#) [00-8196-RDPP](#) [00-8274-RDPP](#) [00-8275-RDNP](#) [00-8609-RDPP](#) [00-8722-RDPP](#) [00-8728-WHPP](#) [00-8869-RDPP](#) [00-](#)
[9051-RDPP](#) [00-9091-LRPP](#) [00-9291-RDPP](#)