

CMOS LDO Regulators for Portable Equipments

1ch 200mA CMOS LDO Regulators



BUxxSA4 series

● **General Description**

BUxxSA4 series are high-performance CMOS LDO regulators with output current ability of up to 200-mA. These devices have excellent noise and load response characteristics despite of its low circuit current consumption of 40μA. They are most appropriate for various applications such as power supplies for logic IC, RF, and camera modules.

● **Features**

- High Output Voltage Accuracy: ±0.6% (±15mV on VOUT<2.5V)
- High Ripple Rejection: 70 dB (Typ, 1 kHz,)
- Compatible with small ceramic capacitor (Cin=Cout=0.47 μF)
- Low Current Consumption: 40 μA
- Output Voltage ON/OFF control
- Built-in Over Current Protection Circuit (OCP)
- Built-in Thermal Shutdown Circuit (TSD)
- Adopting ultra-small WLCSP UCSP50L1

● **Applications**

- Portable devices
- Camera modules
- Other electronic devices using microcontrollers or logic circuits

● **Key Specifications**

- Input Power Supply Voltage Range: 1.7V to 5.5V
- Output Current Range: 0 to 200mA
- Operating Temperature Range: -40°C to +85°C
- Output Voltage Lineup: 1.8V,2.5V,2.55V
2.8V,3.0V,3.3V
- Output Voltage Accuracy: ±0.6%
- Circuit Current: 40μA(Typ.)
- Standby Current: 0μA (Typ.)

● **Package**

UCSP50L1(BUXXSA4WGWL) W(Typ.) x D(Typ.) x H(Max.)
0.8mm x 0.8mm x 0.5mm

● **Typical Application Circuit**

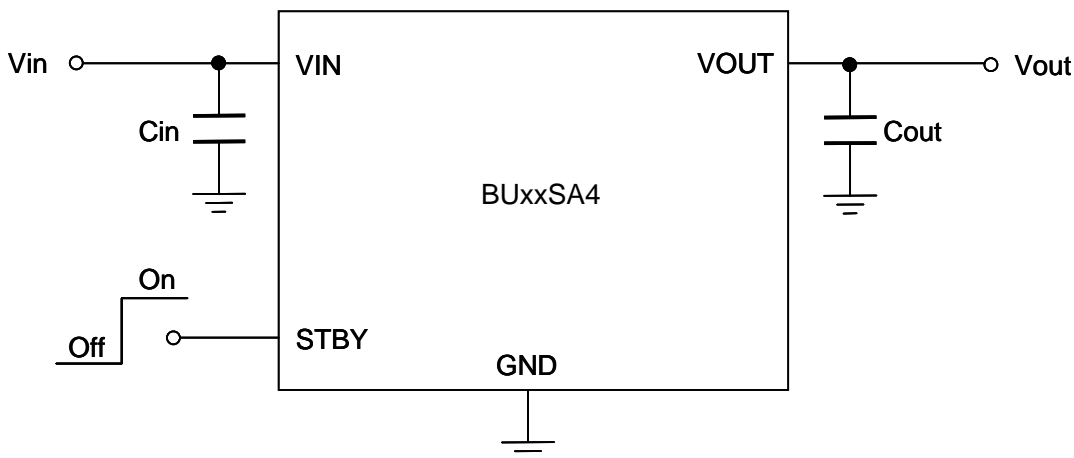
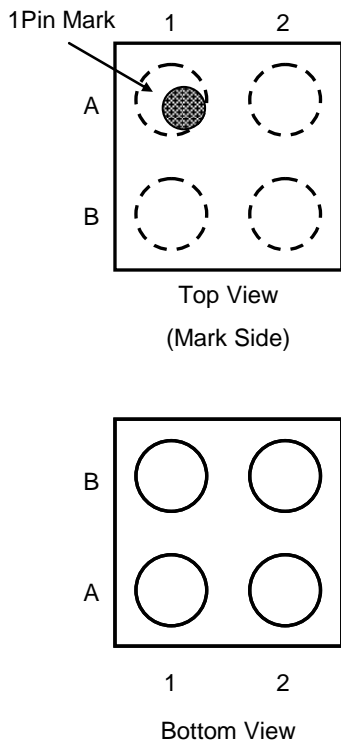

Figure 1. Typical Application Circuit

●Pin Configuration



●Pin Description

Pin No.	Symbol	Function
A1	GND	GND Pin
A2	STBY	Output Control Pin (High:ON, Low:OFF)
B1	VOUT	Output Pin
B2	VIN	Input Pin

●Block Diagram

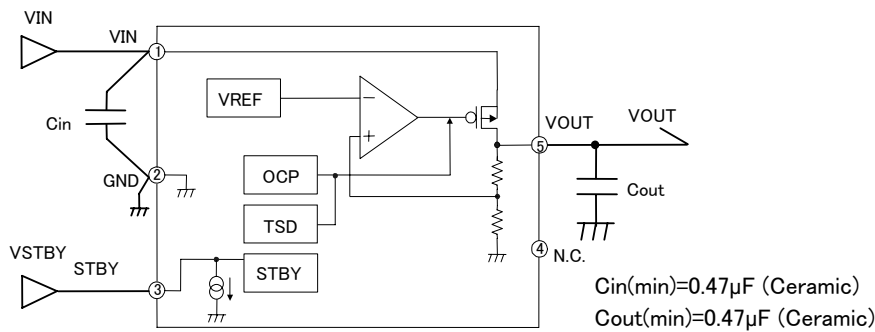

Figure 2. Block diagram

●Absolute Maximum Ratings

Parameter	Symbol	Rating	Unit
Power Supply Voltage	V _{MAX}	-0.3 to +6.5	V
Power Dissipation	P _d	410 ^(*1)	mW
Maximum Junction Temperature	T _{jmax}	+125	°C
Operating Temperature Range	T _{opr}	-40 to +85	°C
Storage Temperature Range	T _{stg}	-55 to +125	°C

(*1) Derate by 4.1mW/°C when operating above T_a=25°C. (When mounted on a board 63mm × 55mm × 1.6mm glass-epoxy board, 9 layer)

●Recommended Operating Ratings

Parameter	Symbol	Limit	Unit
Input Power Supply Voltage Range	V _{IN}	1.7 to 5.5	V

●Recommended Operating Conditions

Parameter	Symbol	Rating			Unit	Conditions
		Min.	Typ.	Max.		
Input capacitor	C _{in}	0.47 ^(*2)	1.0	—	μF	A ceramic capacitor is recommended.
Output capacitor	C _{out}	0.47 ^(*2)	1.0	—	μF	A ceramic capacitor is recommended.

(*2) Set the value of the capacitor so that it does not fall below the minimum value. Take into consideration the temperature characteristics, DC device characteristics, and degradation with time.

●Electrical Characteristics

(Unless otherwise noted, $T_a = -25^\circ\text{C}$, $V_{IN} = V_{OUT} + 1.0\text{V}^{(*)6}$, $V_{STBY} = 1.5\text{V}$, $C_{in} = 1\mu\text{F}$, $C_{out} = 1\mu\text{F}$.)

PARAMETER	Symbol	Limit			Unit	Conditions
		MIN.	TYP.	MAX.		
Output Voltage 1	VOUT1	$V_{OUT} \times 0.994$	VOUT	$V_{OUT} \times 1.006$	V	$I_{OUT} = 10\mu\text{A}$, $V_{OUT} \geq 2.5\text{V}$
		VOUT -15mV		$V_{OUT} + 15\text{mV}$		$I_{OUT} = 10\mu\text{A}$, $V_{OUT} < 2.5\text{V}$
Output Voltage 2	VOUT2	$V_{OUT} \times 0.98$	VOUT	$V_{OUT} \times 1.02$	V	$I_{OUT} = 0$ to 200mA , $V_{OUT} \geq 2.5\text{V}$ $V_{IN} = V_{OUT} + 0.5$ to 5.5V $T_a = -40$ to $+85^\circ\text{C}^{(*)3,4,5}$
		VOUT -50mV		$V_{OUT} + 50\text{mV}$		$I_{OUT} = 0$ to 200mA , $V_{OUT} < 2.5\text{V}$ $V_{IN} = 3.0$ to 5.5V $T_a = -40$ to $+85^\circ\text{C}^{(*)3,4,5}$
Circuit Current 1	IGND1	-	40	65	μA	$I_{OUT} = 0\text{mA}$
Circuit Current 2	IGND2	-	40	80	μA	$T_a = -40$ to $+85^\circ\text{C}^{(*)4}$, $I_{OUT} = 0\text{mA}$
Circuit Current (STBY)	ICCST	-	-	1.0	μA	STBY=0V
Ripple Rejection Ratio1	RR1	-	70	-	dB	VRR=-20dBv, fRR=1kHz, $I_{OUT} = 10\text{mA}$
Ripple Rejection Ratio2	RR2	-	55	-	dB	VRR=-20dBv, fRR=10kHz, $I_{OUT} = 10\text{mA}$
Ripple Rejection Ratio3	RR3	-	45	-	dB	VRR=-20dBv, fRR=100kHz, $I_{OUT} = 10\text{mA}$
Dropout Voltage	VDROP	-	80	150	mV	$V_{IN} = 0.98 \times V_{OUT}$, $I_{OUT} = 100\text{mA}$ $T_a = -40$ to $+85^\circ\text{C}$, $V_{OUT} \geq 2.5\text{V}$
		-	150	360	mV	$V_{IN} = 0.98 \times V_{OUT}$, $I_{OUT} = 100\text{mA}$ $T_a = -40$ to $+85^\circ\text{C}$, $V_{OUT} < 2.5\text{V}$
Load transient resp.	VLOT	-	± 65	-	mV	$I_o = 1$ to 150mA , $T_{rise} = T_{fall} = 1\mu\text{s}$, $V_{IN} = V_{OUT} + 1.0\text{V}^{(*)4}$
Line Transient resp.	VLIT	-	± 5	-	mV	$V_{IN} = V_{OUT} + 0.5$ to $V_{OUT} + 1.0\text{V}$, $T_{rise} = T_{fall} = 10\mu\text{s}$
Output noise voltage	VNOIS	-	30	-	μVrms	Bandwidth 10 to 100kHz
Startup time	TST	-	100	300	μsec	Output voltage settled within tolerancies
Line Regulation	VDLI	-	2	8	mV	$I_{OUT} = 10\text{mA}$ $V_{IN} = V_{OUT} + 0.5$ to $5.5\text{V}^{(*)5}$
Load Regulation1	VDLO1	-	2	8	mV	$I_{OUT} = 1$ to 100mA
Load Regulation2	VDLO2	-	4	16	mV	$I_{OUT} = 1$ to 200mA
Maximum Output Current	IOMAX	200	-	-	mA	$V_{IN} = V_{OUT} + 1.0\text{V}^{(*)6}$
Limit Current	ILMAX	250	400	-	mA	$V_o = V_{OUT} \times 0.98$
Short Current	ISHORT	-	100	200	mA	$V_o = 0\text{V}$
STBY Pin Current	ISTBY	-	-	4.0	μA	$T_a = -40$ to $+85^\circ\text{C}$
STBY Control Voltage	ON	VSTBH	1.1	-	V	
	OFF	VSTBL	-0.2	-	0.5	

(*)3) Operating conditions are limited by Pd.

(*)4) Typical values apply for $T_a = 25^\circ\text{C}$.

(*)5) $V_{IN} = 3.0\text{V}$ to 5.0V for $V_{OUT} < 2.5\text{V}$.

(*)6) $V_{IN} = 3.5\text{V}$ for $V_{OUT} < 2.5\text{V}$.

●Reference data BU18SA4WGWL (Unless otherwise specified, $T_a=25^\circ\text{C}$.)

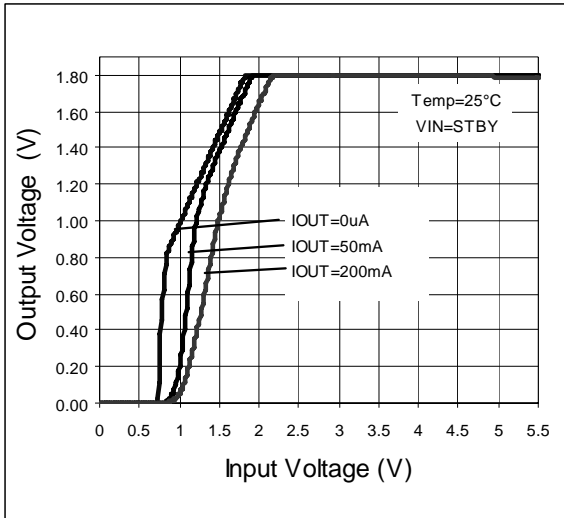

Figure 3. Output Voltage vs. Input Voltage

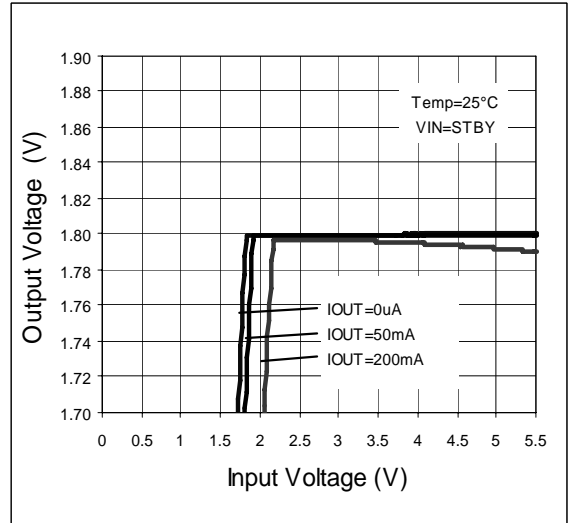

Figure 4. Line Regulation

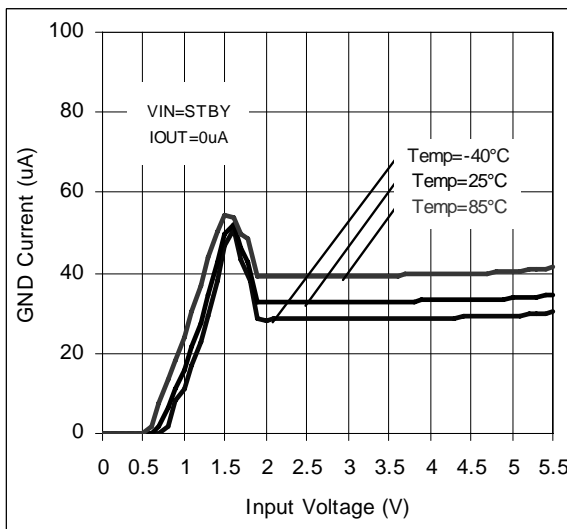

Figure 5. GND Current vs. Input Voltage

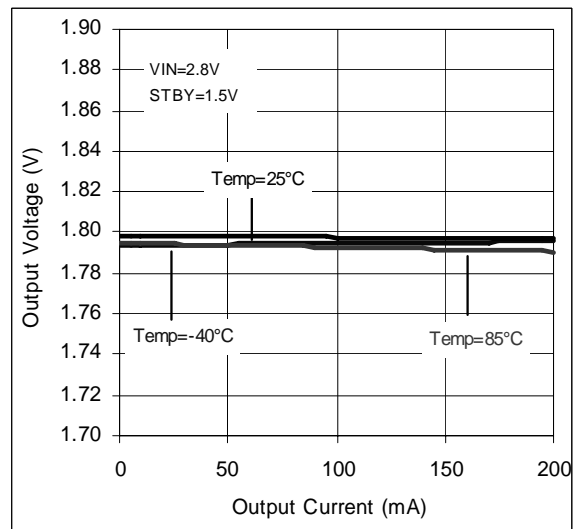

Figure 6. Load Regulation

●Reference data BU18SA4WGWL (Unless otherwise specified, Ta=25°C.)

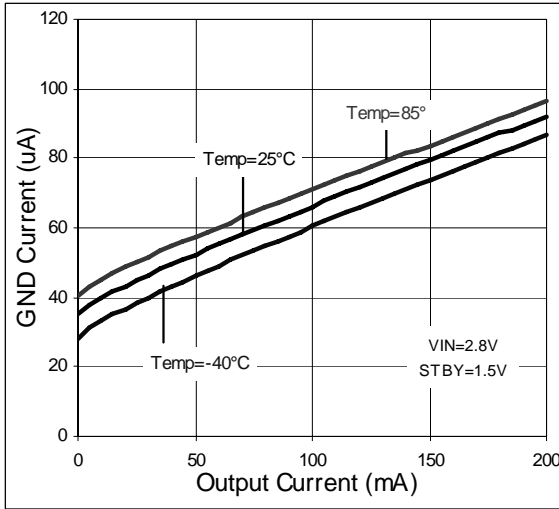

Figure 7. GND Current vs. Output Current

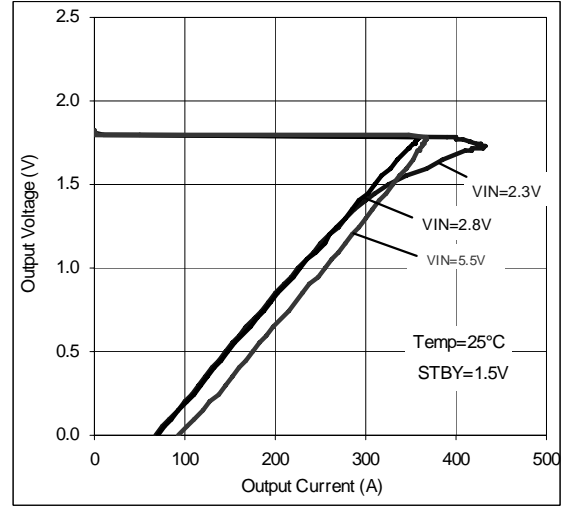

Figure 8. OCP Threshold

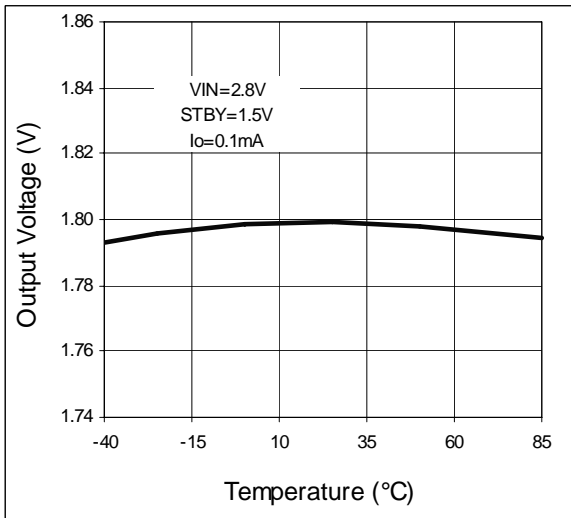

Figure 9. Output Voltage vs. Temperature

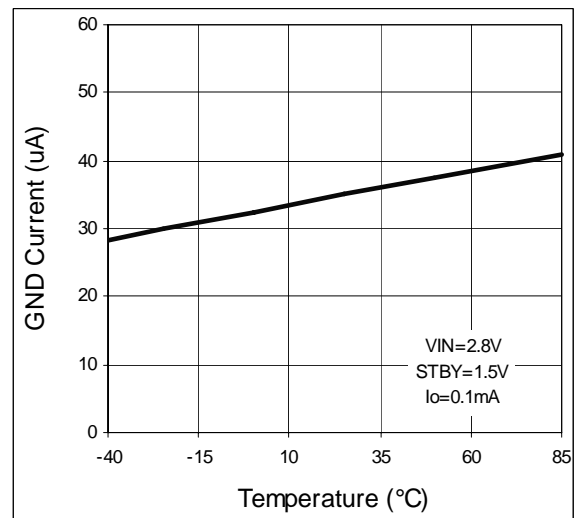

Figure 10. GND Current vs. Temperature

●Reference data BU18SA4WGWL (Unless otherwise specified, Ta=25°C.)

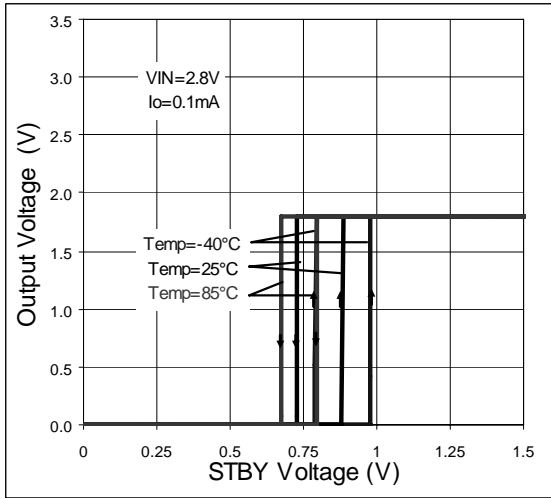

Figure 11. STBY Threshold

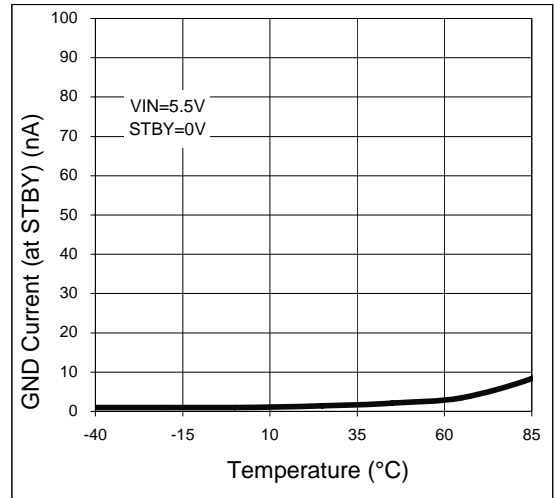

Figure 12. GND Current (at STBY) vs. Temperature

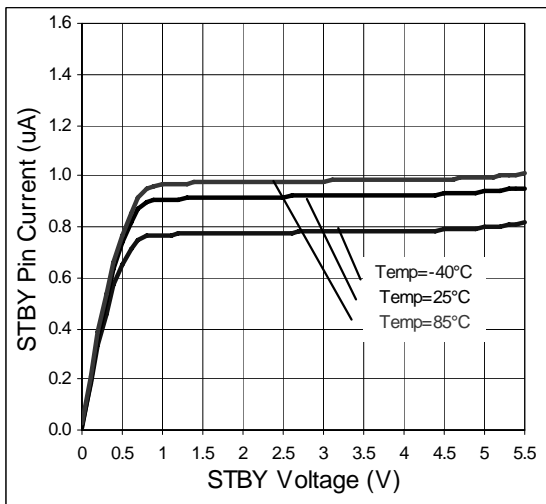

Figure 13. STBY Pin Current vs. STBY Pin Voltage

●Reference data BU18SA4WGWL (Unless otherwise specified, Ta=25°C,Cin = Cout =1μF.)

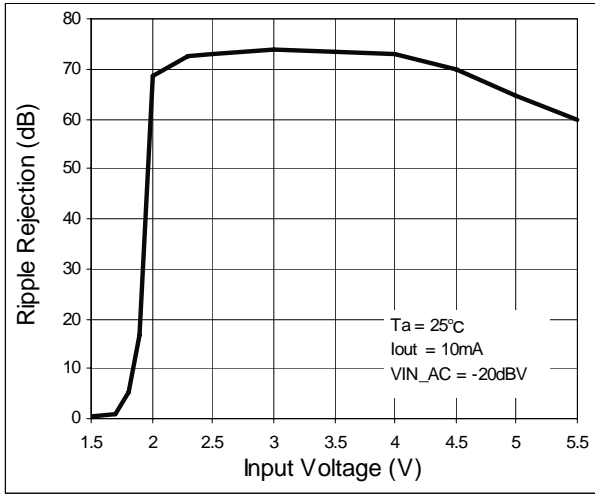

Figure 14. Ripple Rejection vs. Input Voltage

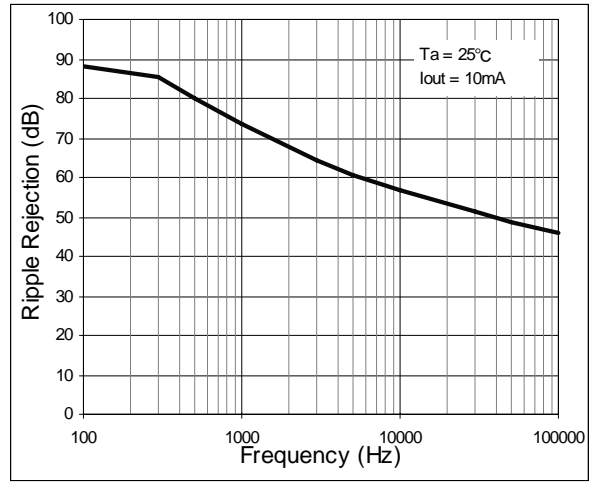

Figure 15. Ripple Rejection vs. Frequency

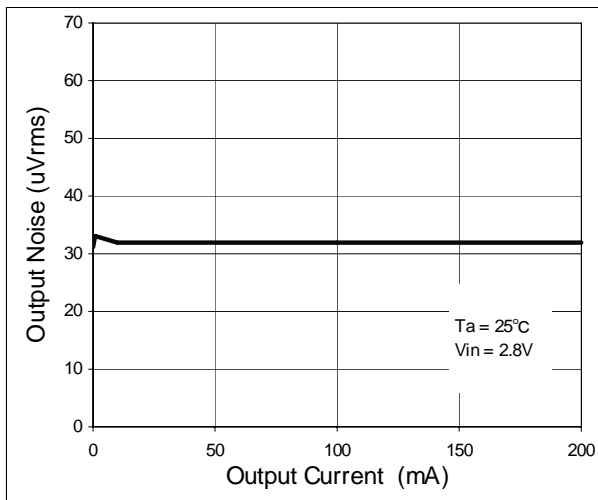

Figure 16. Output Noise vs. Output Current

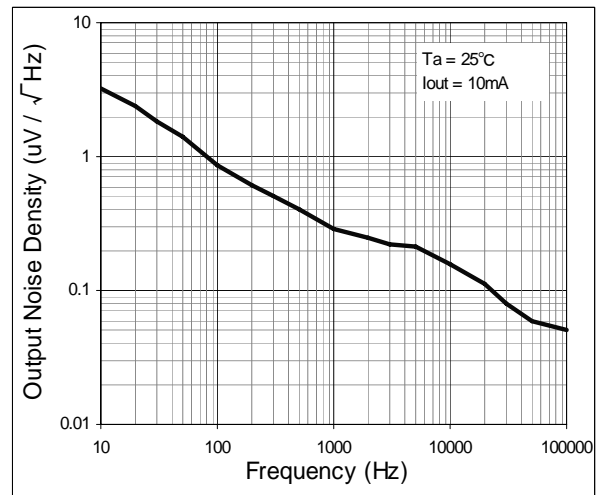

Figure 17. Output Noise Density vs. Frequency

●Reference data BU18SA4WGWL (Unless otherwise specified, Ta=25°C, Cin = Cout =1μF.)

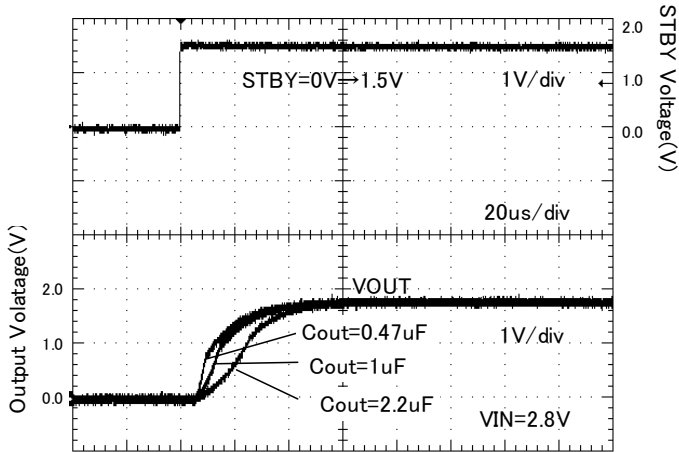

Figure 18. Startup time (Rout = none)

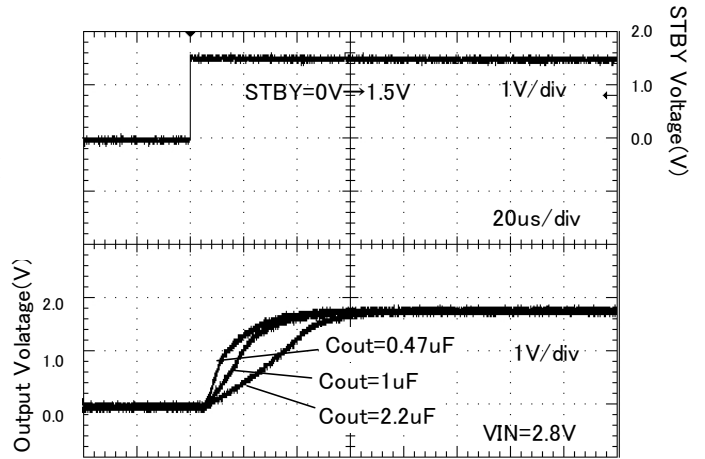

Figure 19. Startup time (Rout = 9 ohm)

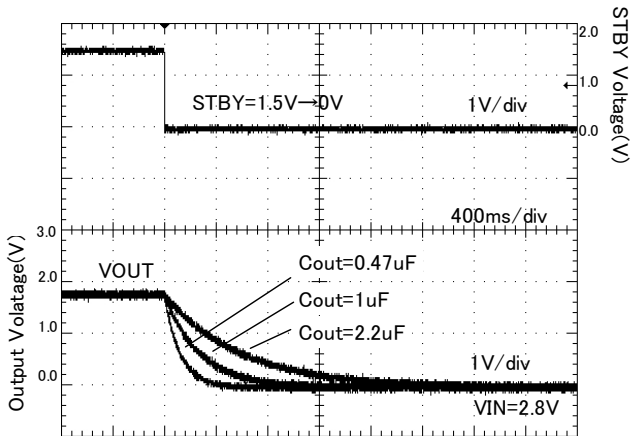

Figure 20. Discharge time (Rout = none)

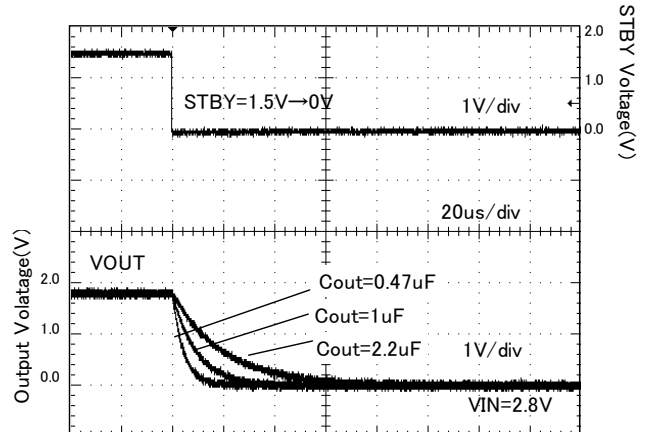

Figure 21. Discharge time (Rout = 9 ohm)

●Reference data BU18SA4WGWL (Unless otherwise specified, $T_a=25^{\circ}\text{C}$, $C_{in} = C_{out} = 1\mu\text{F}$.)

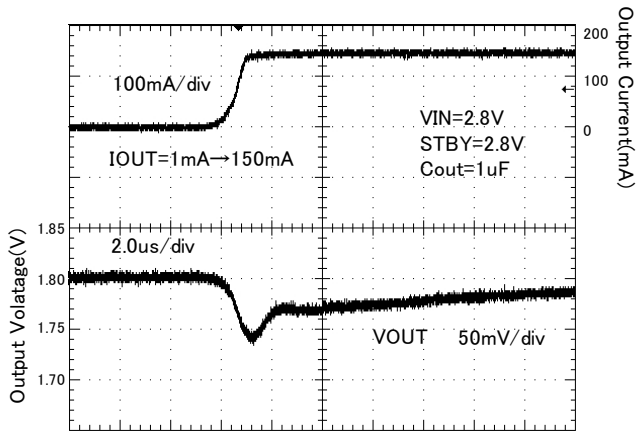

Figure 22. Load response
($I_{out} = 1\text{mA} \rightarrow 150\text{mA}$)

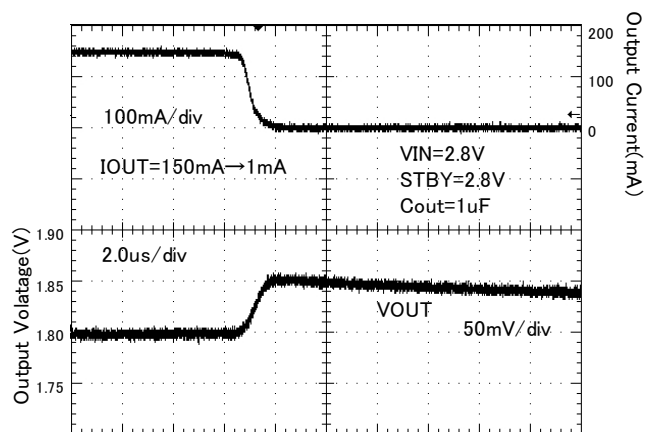

Figure 23. Load response
($I_{out} = 150\text{mA} \rightarrow 1\text{mA}$)

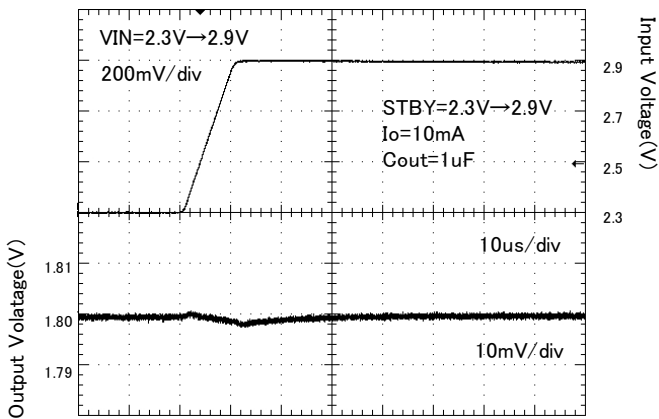

Figure 24. Line response
($V_{in} = 2.3\text{V} \rightarrow 2.9\text{V}$)

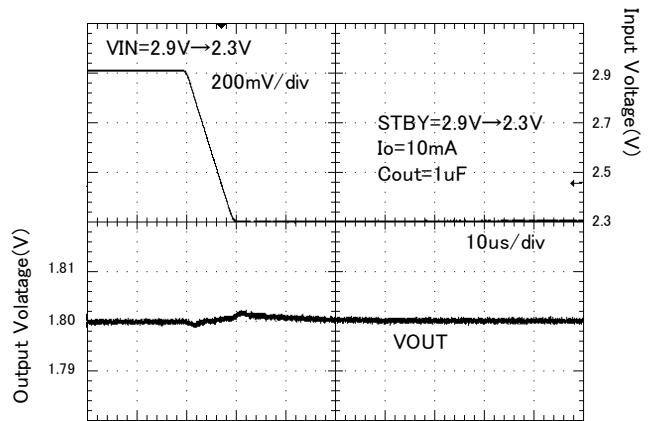

Figure 25. Line response
($V_{in} = 2.9\text{V} \rightarrow 2.3\text{V}$)

●Reference data BU28SA4WGWL (Unless otherwise specified, Ta=25°C.)

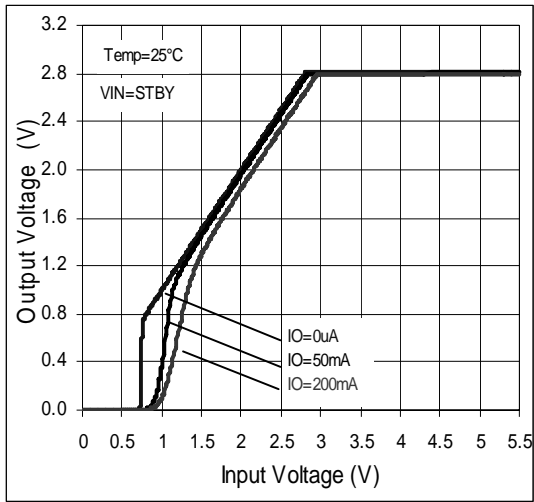

Figure 26. Output Voltage vs. Input Voltage

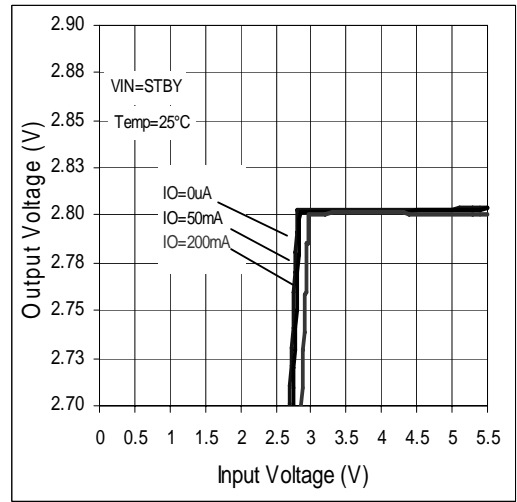

Figure 27. Line Regulation

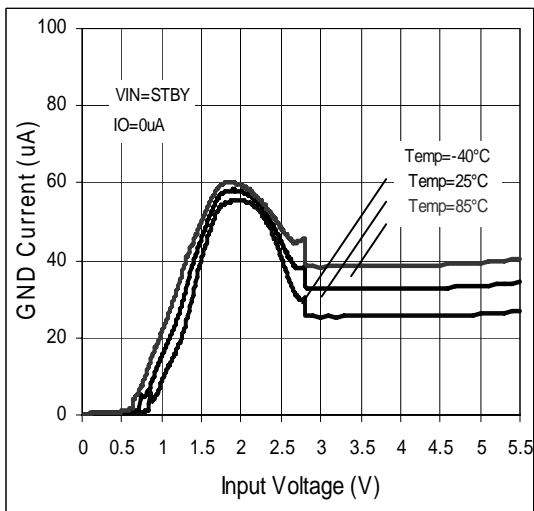

Figure 28. GND Current vs. Input Voltage

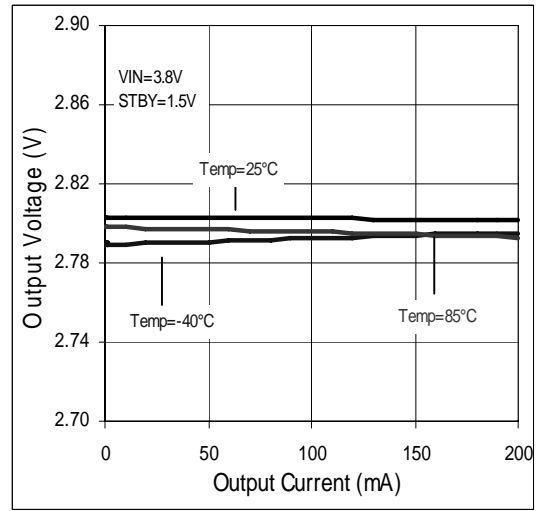

Figure 29. Load Regulation

●Reference data BU28SA4WGWL (Unless otherwise specified, Ta=25°C.)

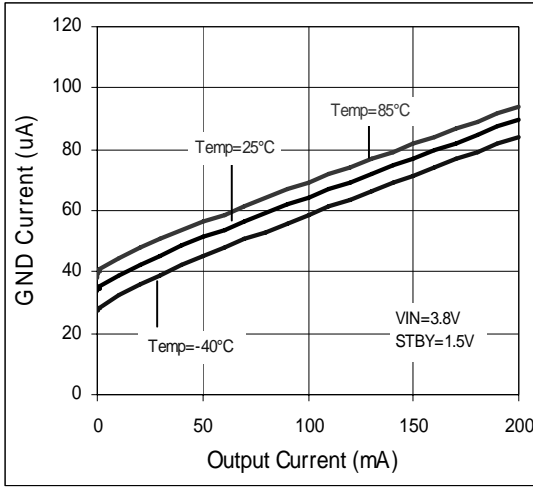

Figure 30. GND Current vs. Output Current

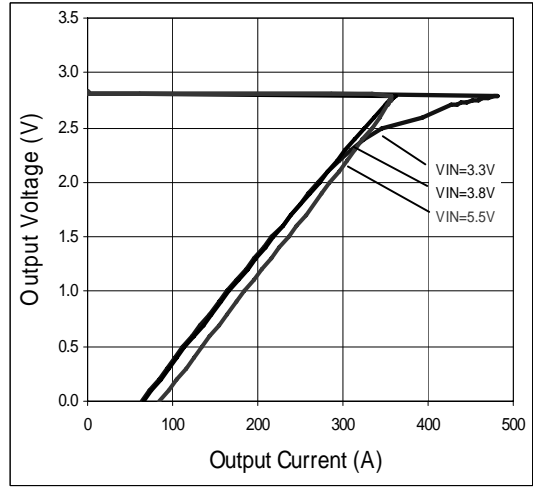

Figure 31. OCP Threshold

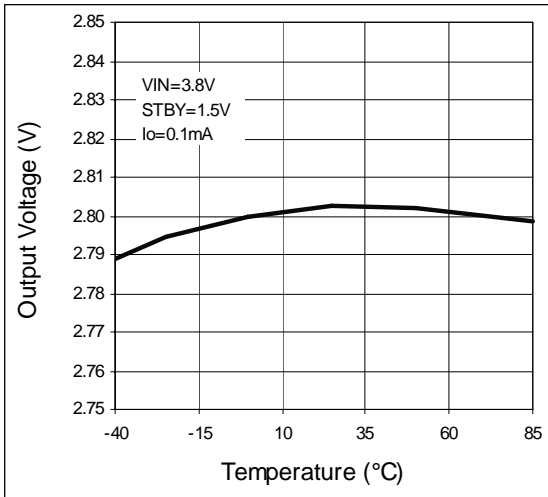

Figure 32. Output Voltage vs. Temperature

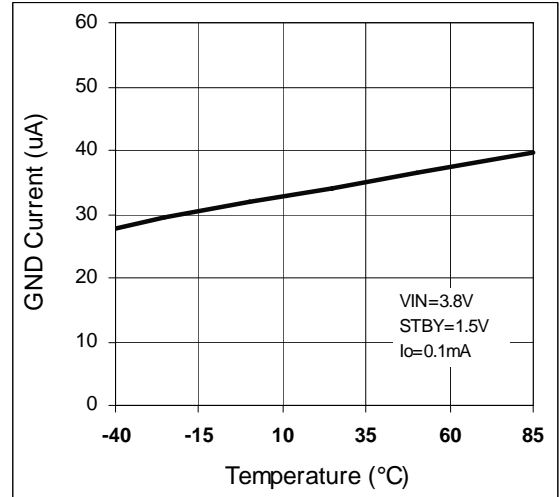

Figure 33. GND Current vs. Temperature

●Reference data BU28SA4WGWL (Unless otherwise specified, Ta=25°C.)

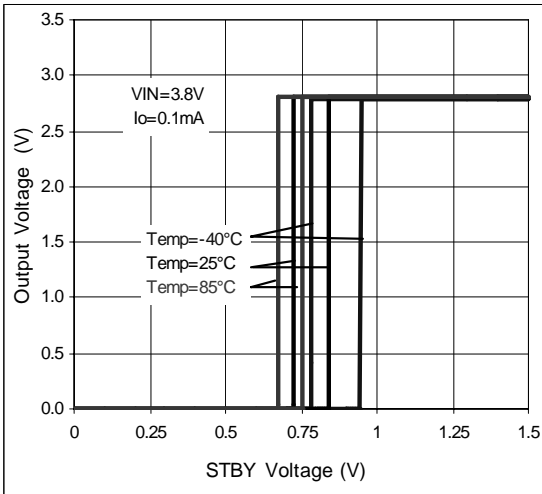

Figure 34. STBY Threshold

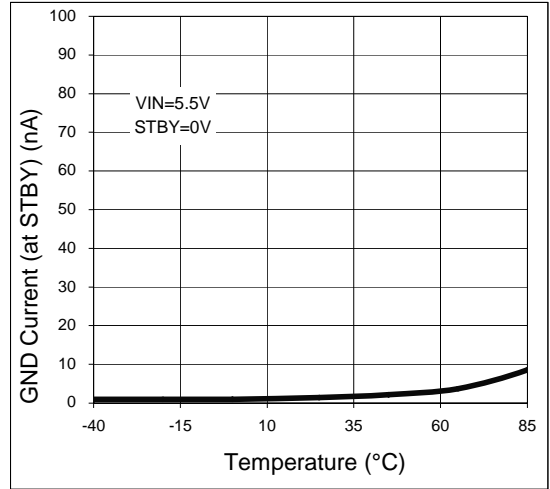

Figure 35. GND Current (at STBY) vs. Temperature

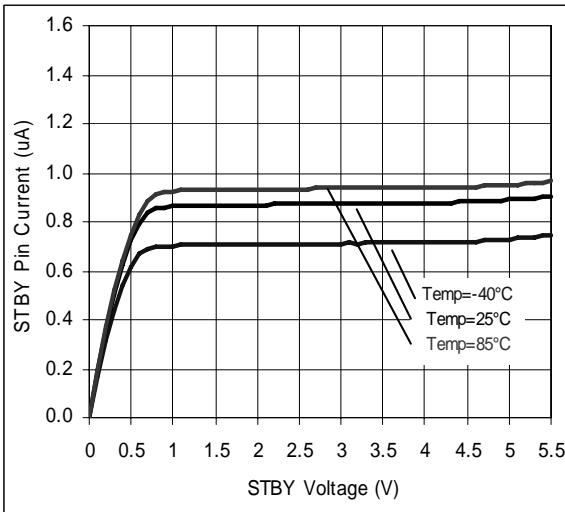

Figure 36. STBY Pin Current vs. STBY Voltage

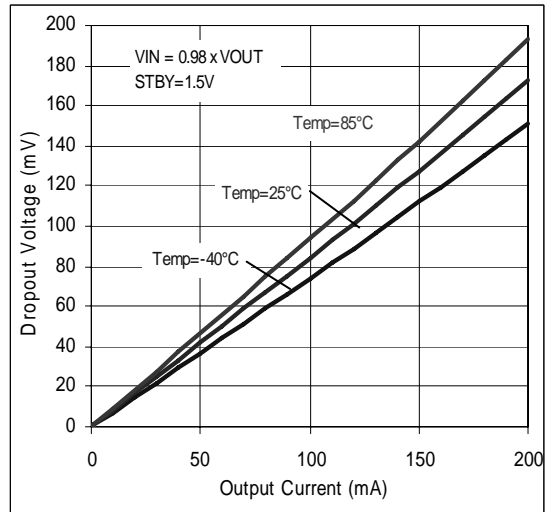

Figure 37. Dropouut Voltage vs. Output Current

●Reference data BU28SA4WGWL (Unless otherwise specified, Ta=25°C,Cin = Cout =1μF.)

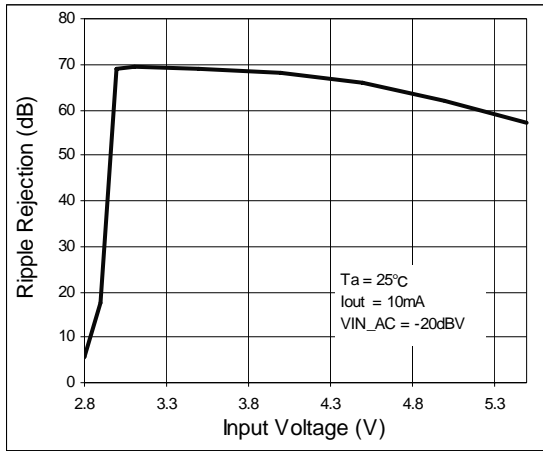

Figure 38. Ripple Rejection vs. Input Voltage

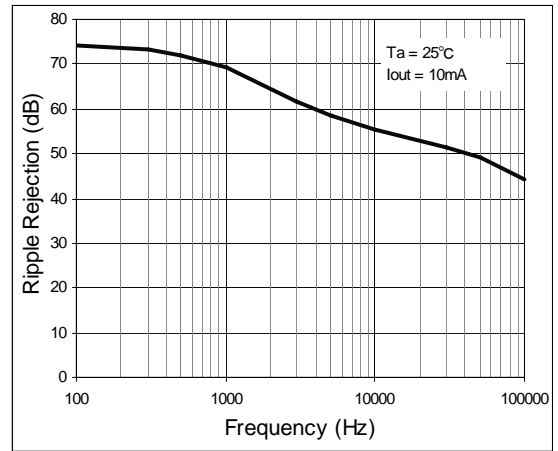

Figure 39. Ripple Rejection vs. Frequency

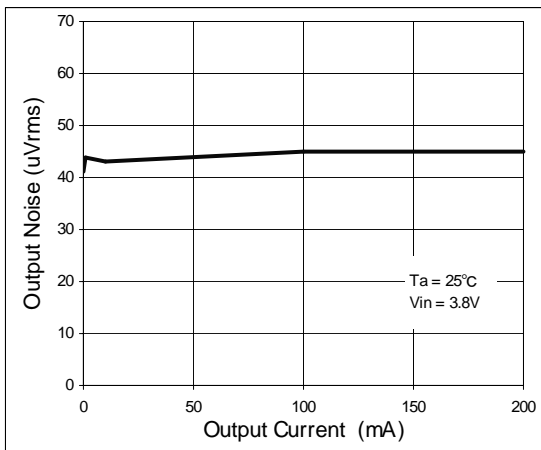

Figure 40. Output Noise vs. Output Current

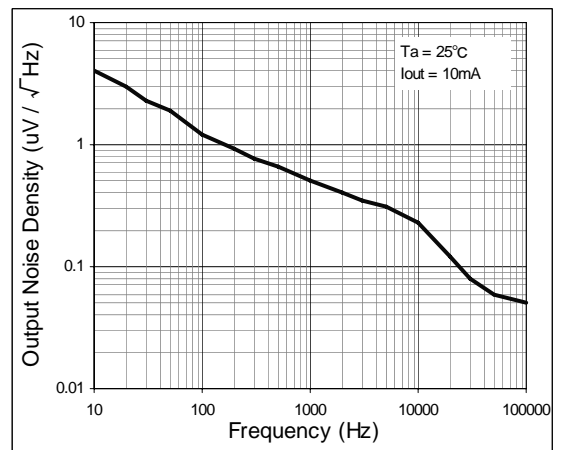

Figure 41. Output Noise Density vs. Frequency

●Reference data BU28SA4WGWL (Unless otherwise specified, Ta=25°C,Cin = Cout =1μF.)

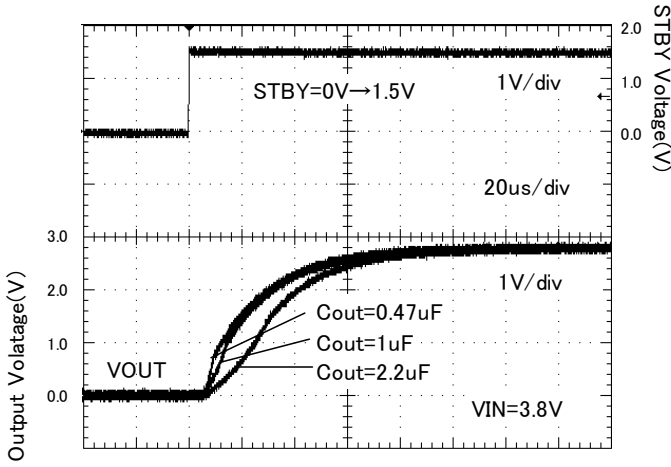

Figure 42. Startup time (Rout = none)

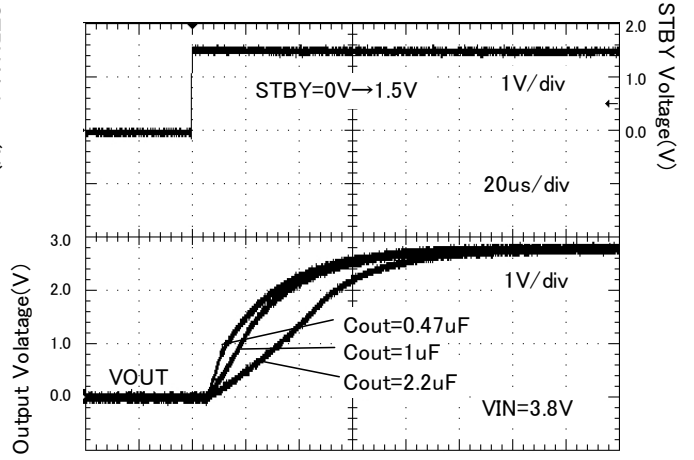

Figure 43. Startup time (Rout = 14 ohm)

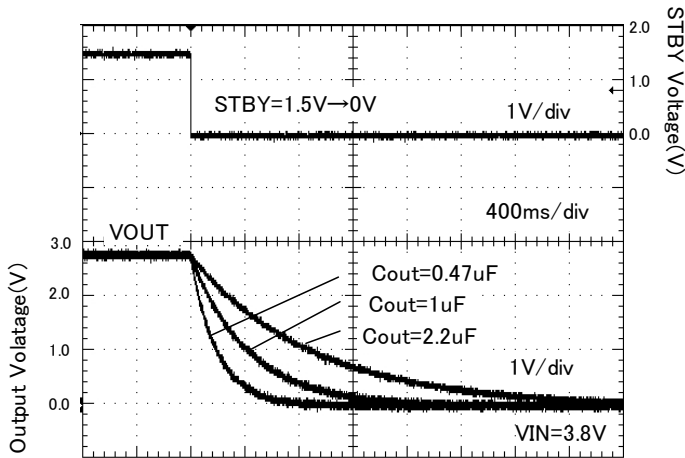

Figure 44. Discharge time (Rout = none)

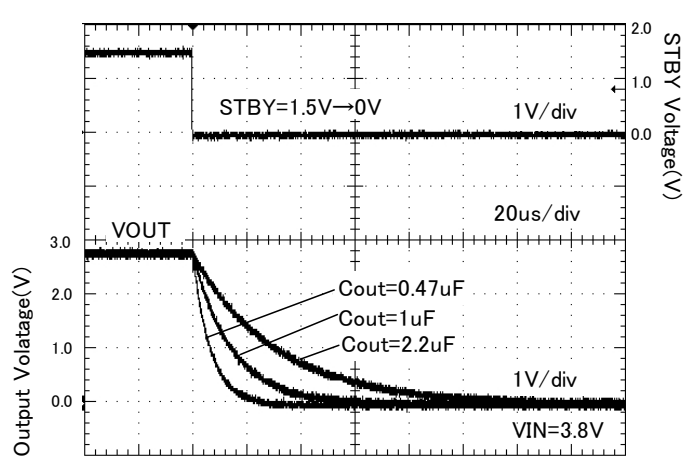

Figure 45. Discharge time (Rout = 14 ohm)

●Reference data BU28SA4WGWL (Unless otherwise specified, Ta=25°C, Cin = Cout =1μF.)

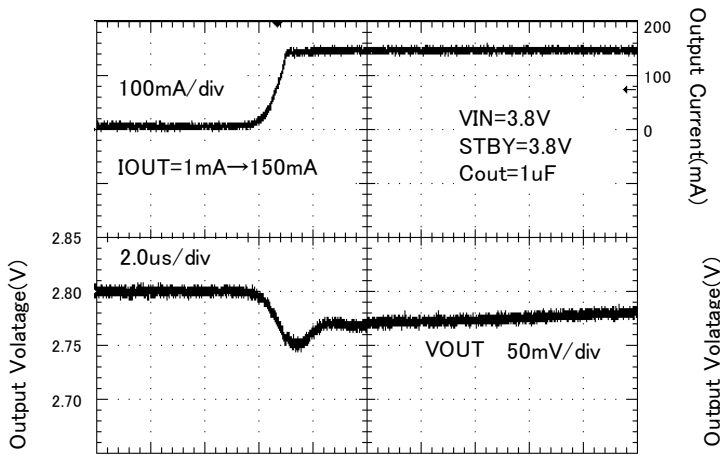

Figure 46. Load response
(Iout = 1mA → 150mA)

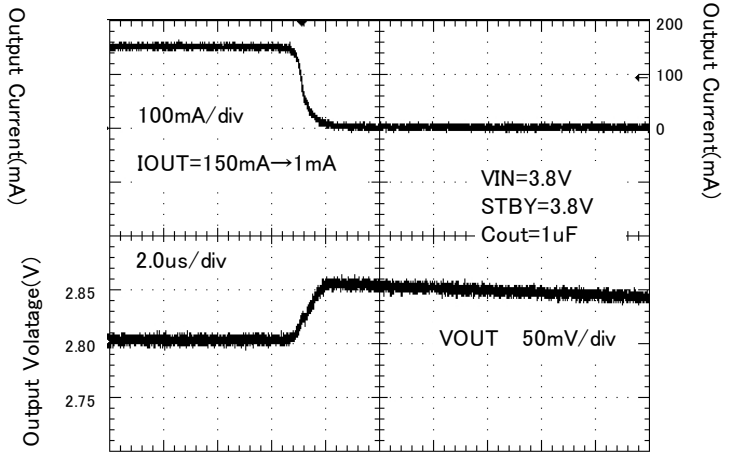

Figure 47. Load response
(Iout = 150mA → 1mA)

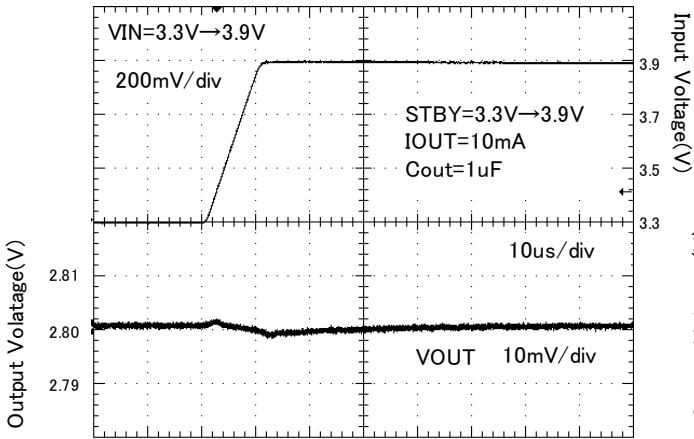

Figure 48. Line response (Vin = 3.3V → 3.9V)

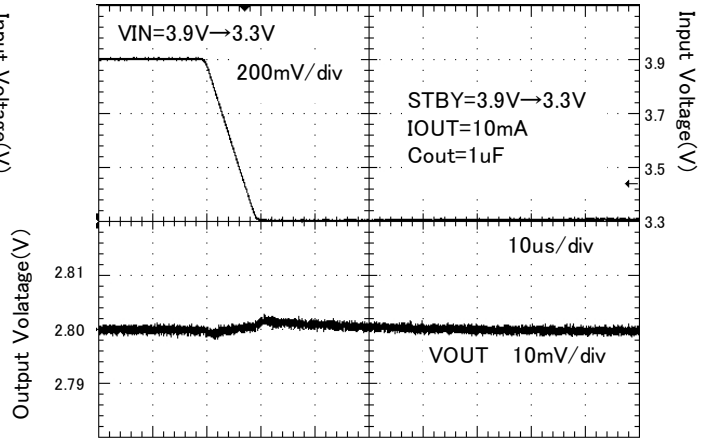

Figure 49. Line response (Vin = 3.9V → 3.3V)

●Reference data BU30SA4WGWL (Unless otherwise specified, Ta=25°C.)

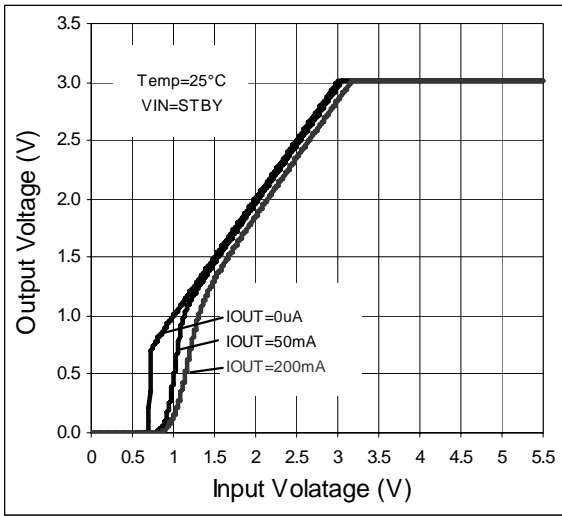

Figure 50. Output Voltage vs. Input Voltage

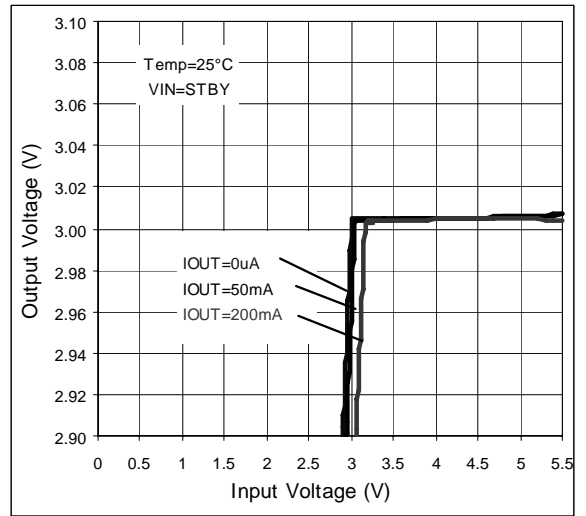

Figure 51. Line Regulation

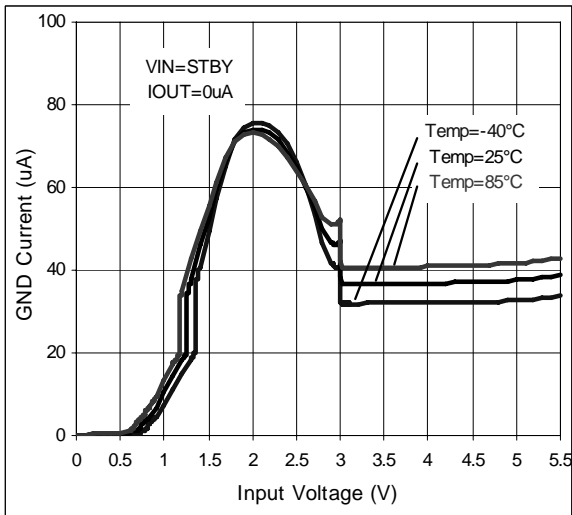

Figure 52. GND Current vs. Input Voltage

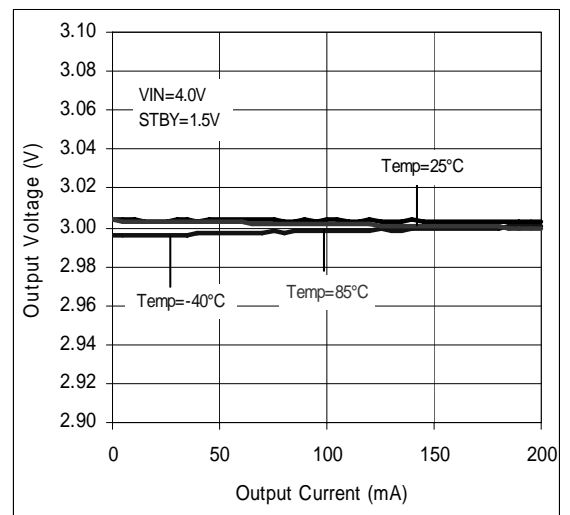

Figure 53. Load Regulation

●Reference data BU30SA4WGWL (Unless otherwise specified, Ta=25°C.)

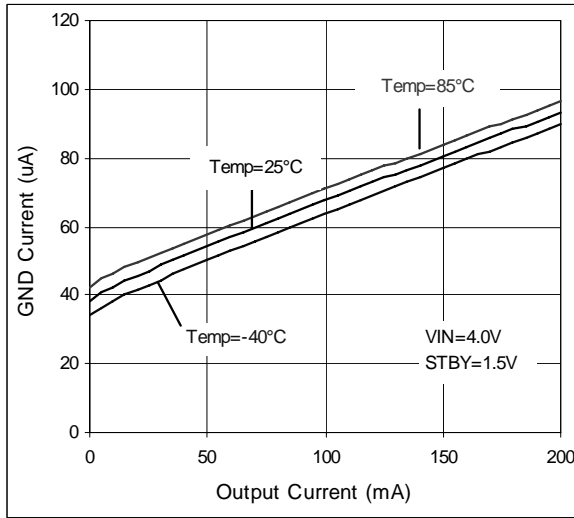

Figure 54. GND Current vs. Output Current

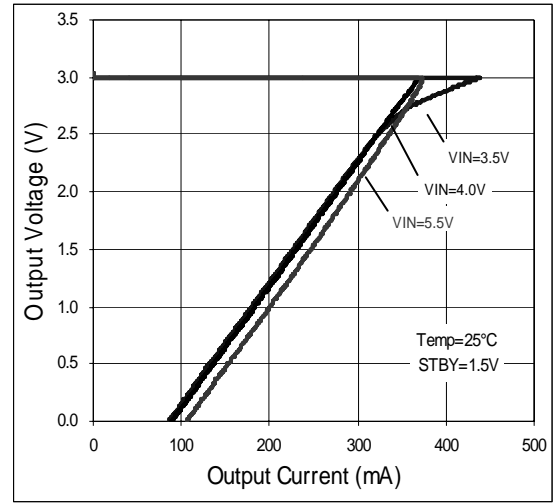

Figure 55. OCP Threshold

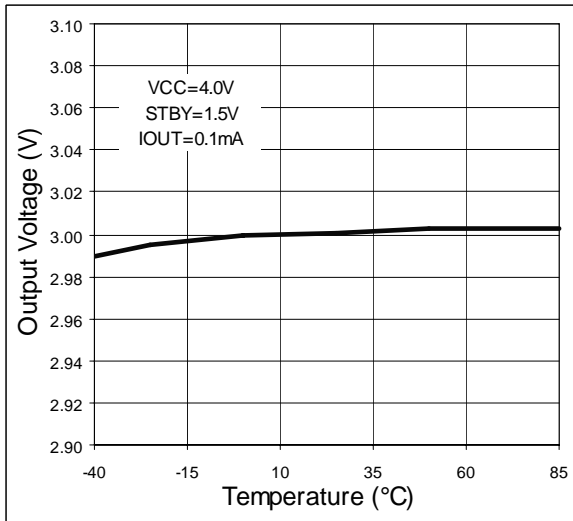

Figure 56. Output Voltage vs. Temperature

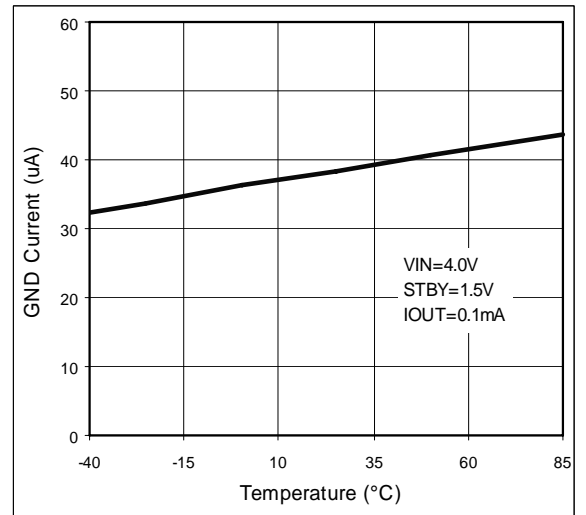

Figure 57. GND Current vs. Temperature

●Reference data BU30SA4WGWL (Unless otherwise specified, Ta=25°C.)

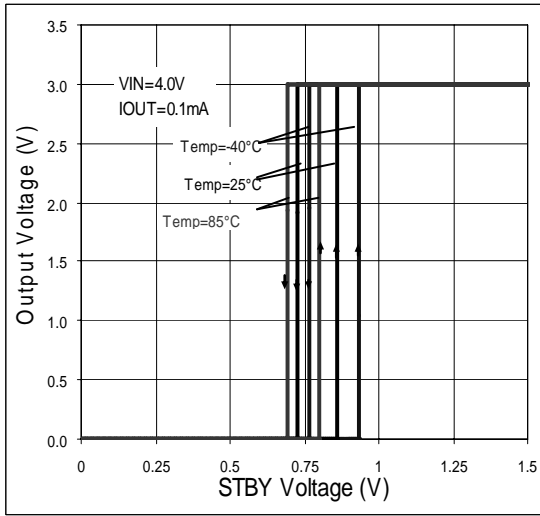

Figure 58. STBY Threshold

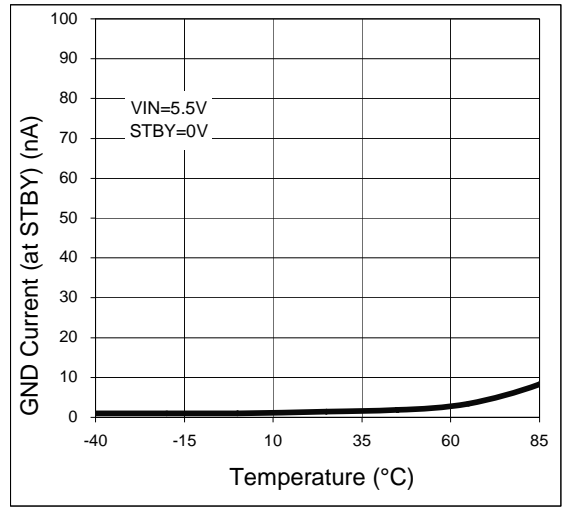

Figure 59. GND Current(at STBY) vs. Temperature

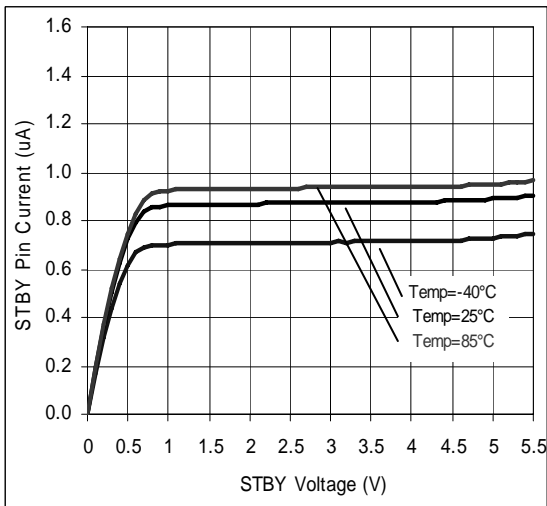

Figure 60. STBY Pin Voltage vs. STBY Pin Current

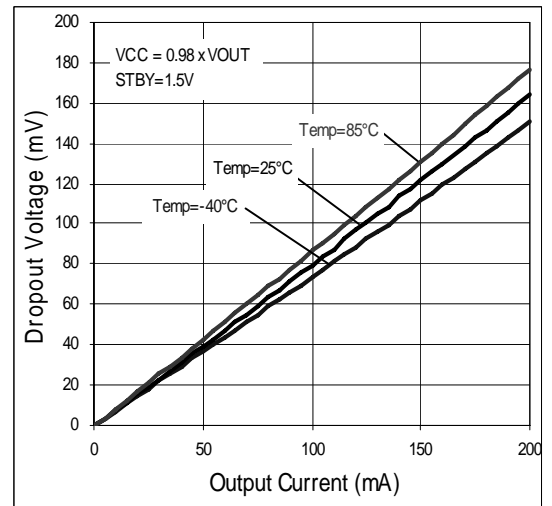

Figure 61. Dropout Voltage vs. Output Current

●Reference data BU30SA4WGWL (Unless otherwise specified, Ta=25°C,Cin = Cout =1μF.)

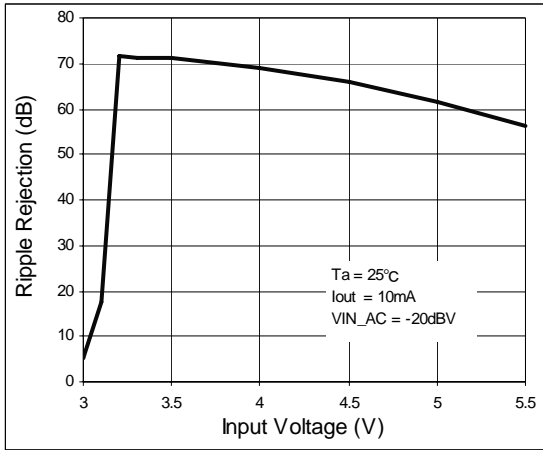

Figure 62. Ripple Rejection vs. Input Voltage

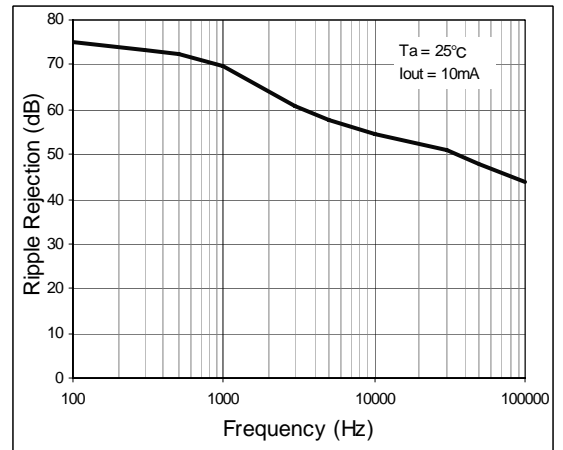

Figure 63. Ripple Rejection vs. Frequency

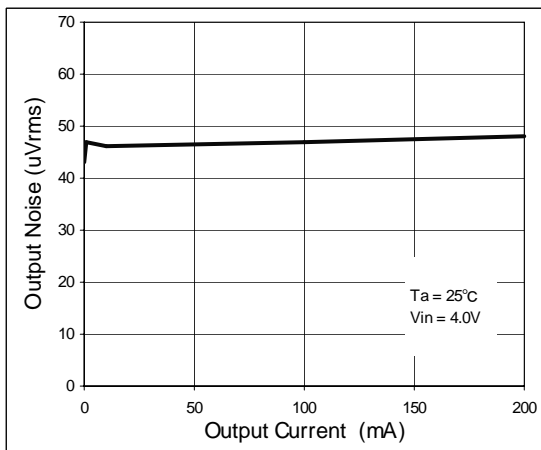

Figure 64. Output Noise vs. Output Current

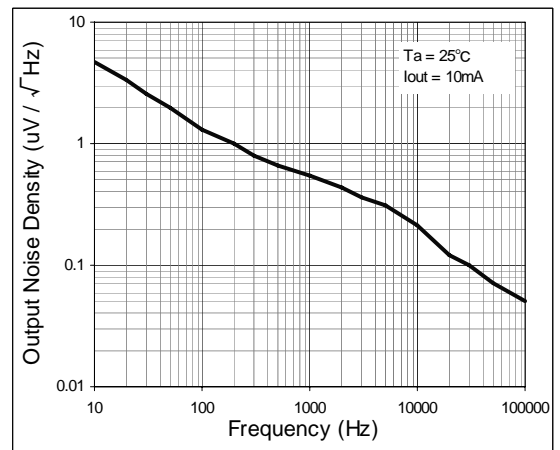

Figure 65. Output Noise Density vs. Frequency

●Reference data BU30SA4WGWL (Unless otherwise specified, Ta=25°C, Cin = Cout =1μF.)

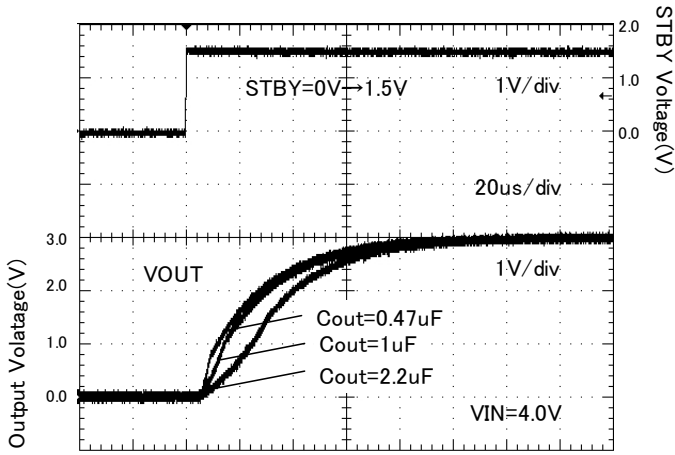

Figure 66. Startup time (Rout = none)

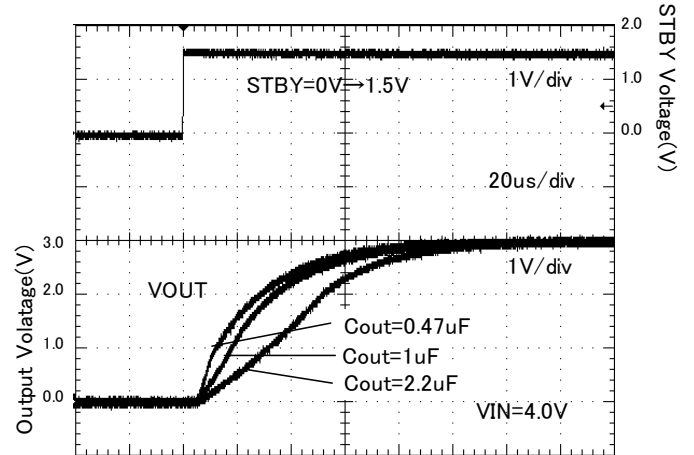

Figure 67. Startup time (Rout = 15 ohm)

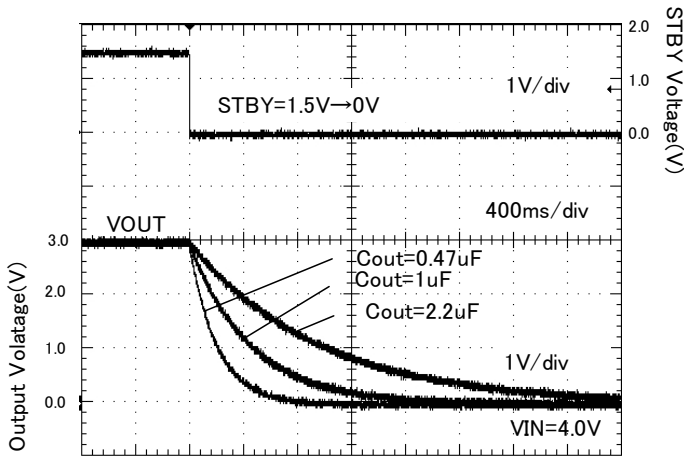

Figure 68. Discharge time (Rout = none)

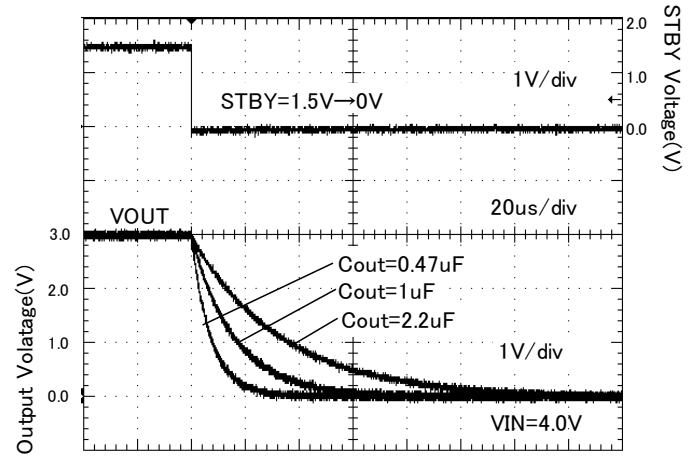

Figure 69. Discharge time (Rout = 15 ohm)

●Reference data BU30SA4WGWL (Unless otherwise specified, Ta=25°C, Cin = Cout =1μF.)

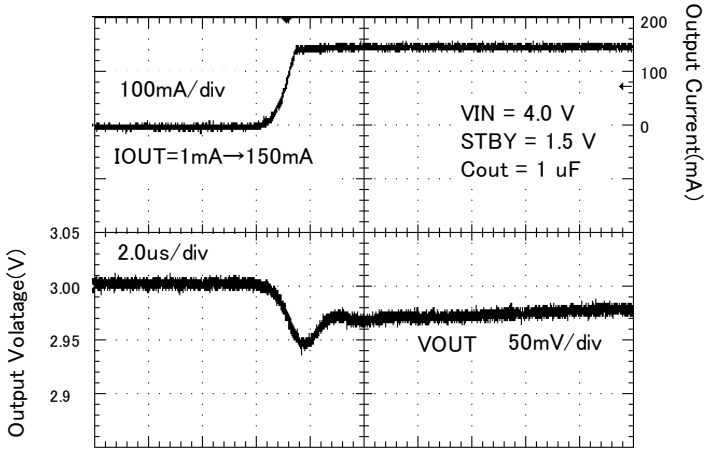

Figure 70. Load response (Iout = 1mA → 150mA)

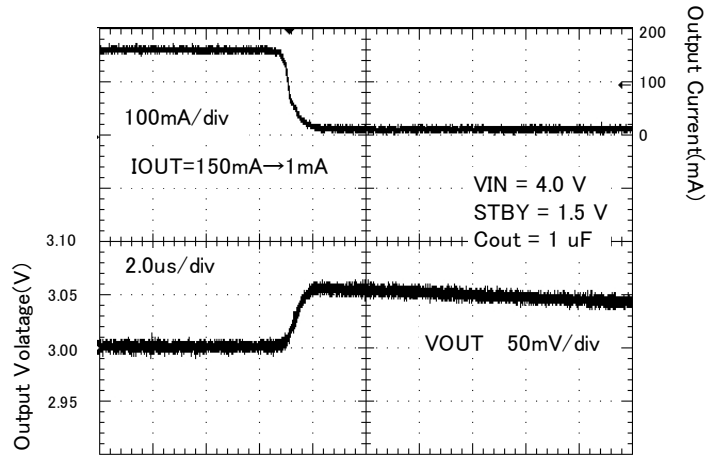

Figure 71. Load response (Iout = 150mA → 1mA)

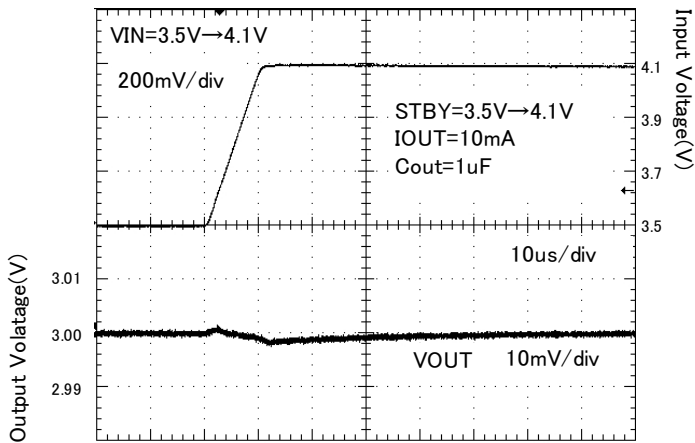

Figure 72. Line response (Vin = 3.5 V → 4.1 V)

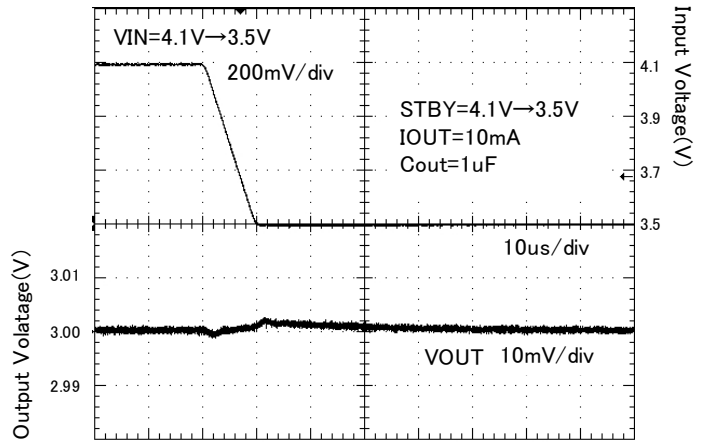

Figure 73. Line response (Vin = 4.1 V → 3.5 V)

●Reference data BU33SA4WGWL (Unless otherwise specified, Ta=25°C.)

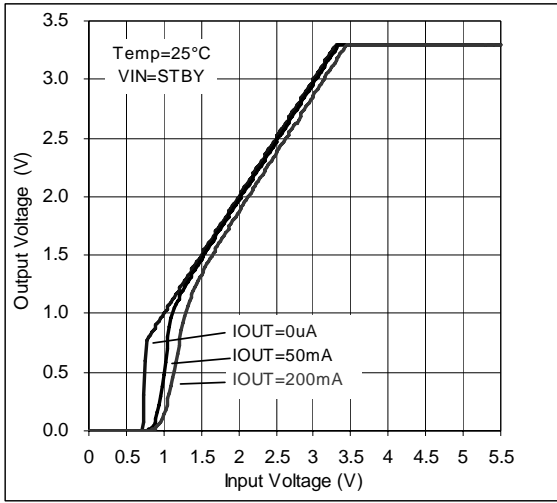

Figure 74. Output Voltage vs. Input Voltage

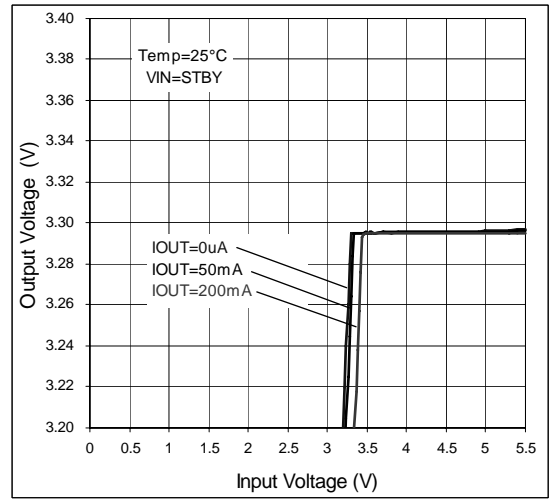

Figure 75. Line Regulation

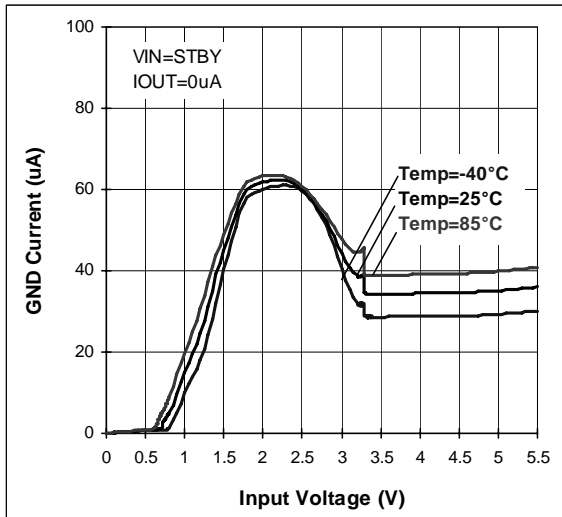

Figure 76. GND Current vs. Input Voltage

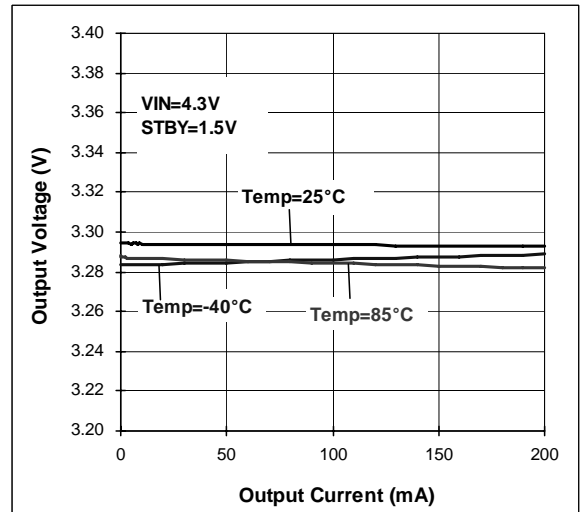

Figure 77. Load Regulation

●Reference data BU33SA4WGWL (Unless otherwise specified, Ta=25°C.)

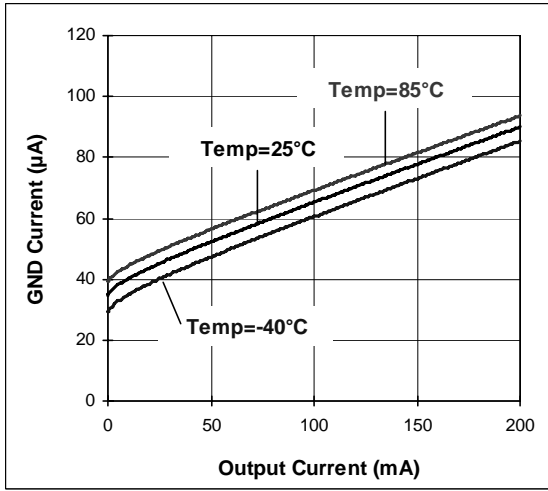

Figure 78. GND Current vs. Output Current

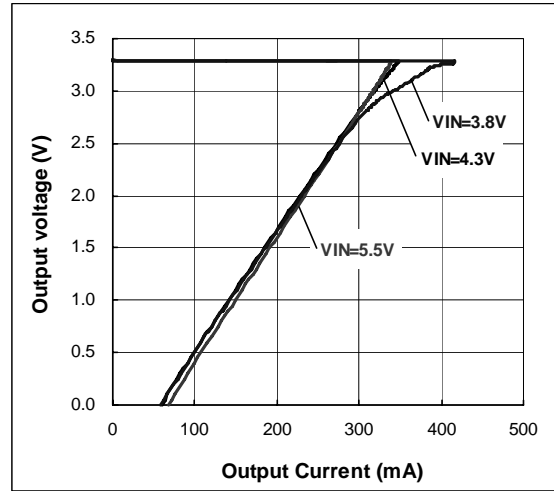

Figure 79. OCP Threshold

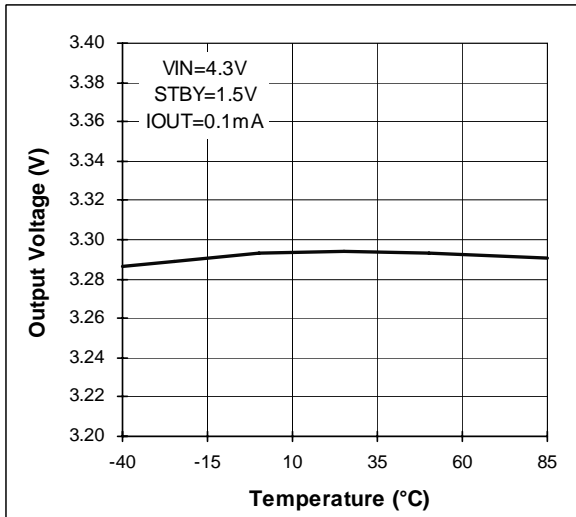

Figure 80. Output Voltage vs. Temperature

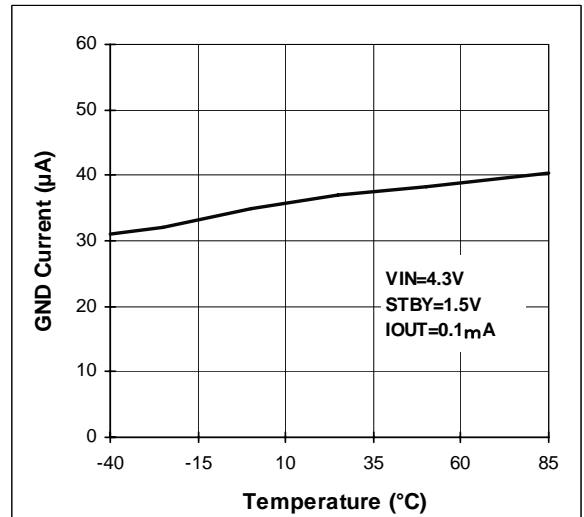

Figure 81. GND Current vs. Temperature

●Reference data BU33SA4WGWL (Unless otherwise specified, Ta=25°C.)

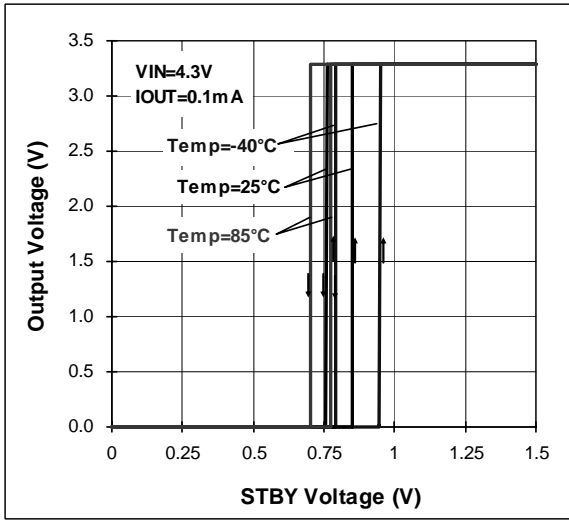

Figure 82. STBY Threshold

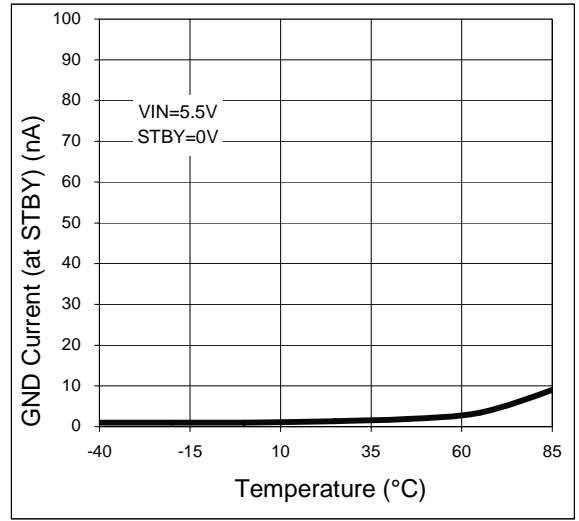

Figure 83. GND Current (at STBY) vs. Temperature

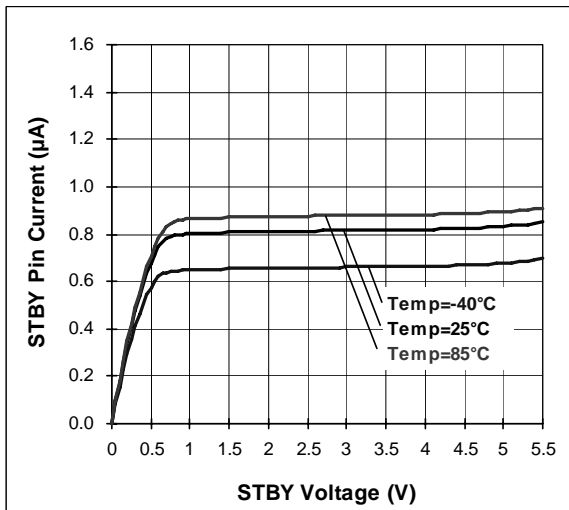

Figure 84. STBY Pin Current vs. STBY Voltage

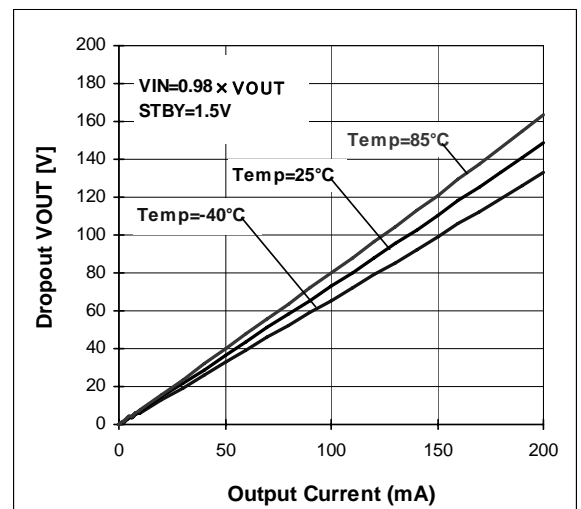

Figure 85. Dropout Voltage vs. Output Current

●Reference data BU33SA4WGWL (Unless otherwise specified, Ta=25°C,Cin = Cout =1μF.)

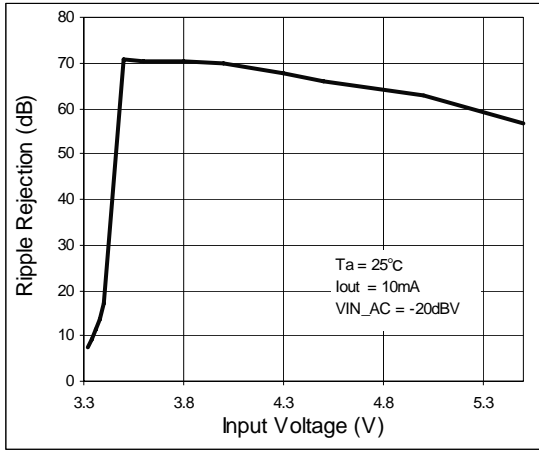

Figure 86. Ripple Rejection vs. Input Voltage

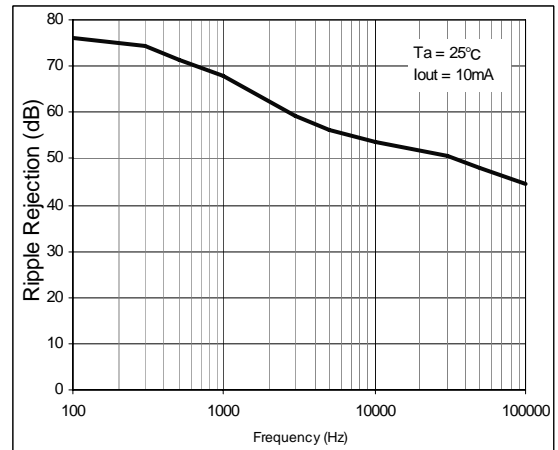

Figure 87. Ripple Rejection vs. Frequency

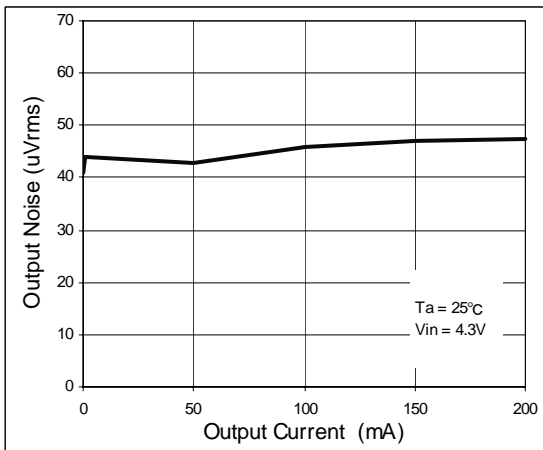

Figure 88. Output Noise vs. Output Current

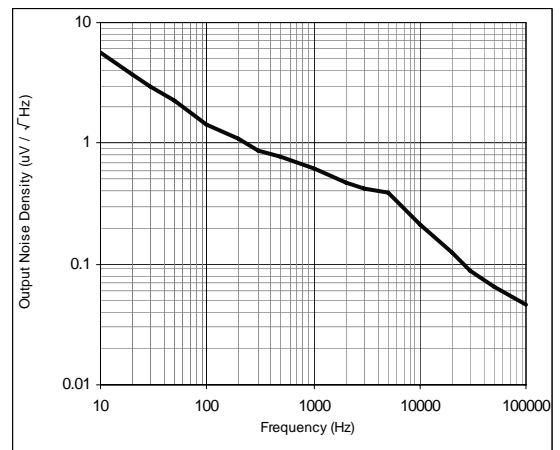

Figure 89. Output Noise Density vs. Frequency

●Reference data BU33SA4WGWL (Unless otherwise specified, Ta=25°C, Cin = Cout =1μF.)

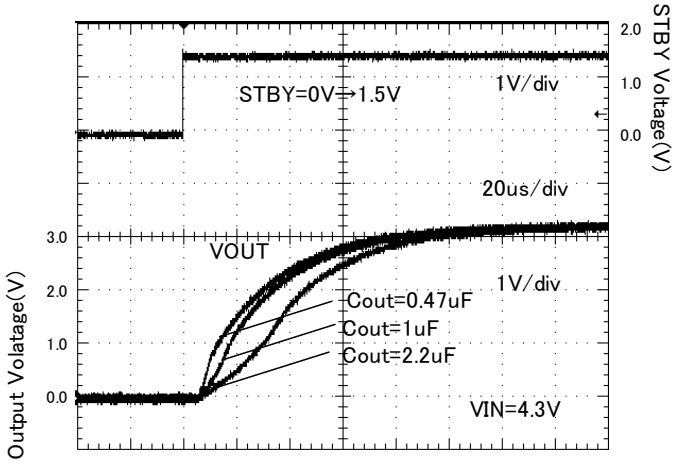

Figure 90. Startup time (Rout = none)

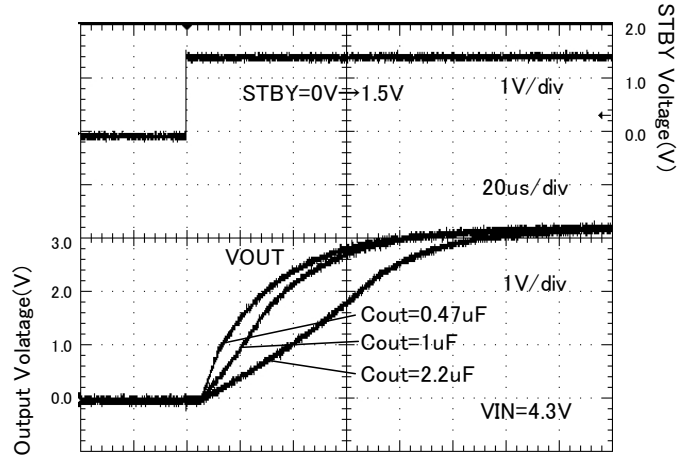

Figure 91. Startup time (Rout = 16.5 ohm)

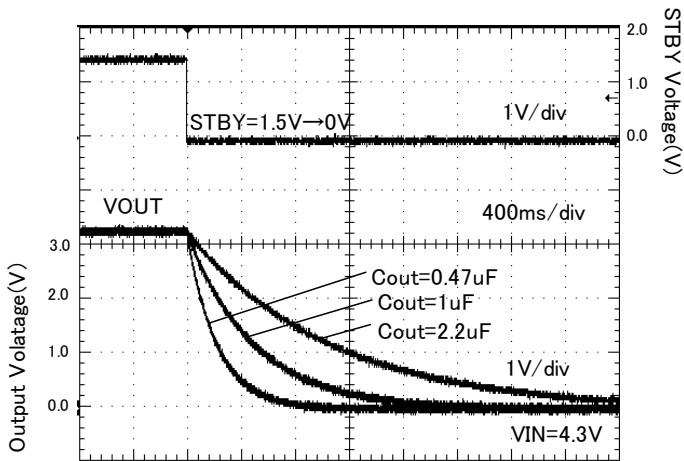

Figure 92. Discharge time (Rout = none)

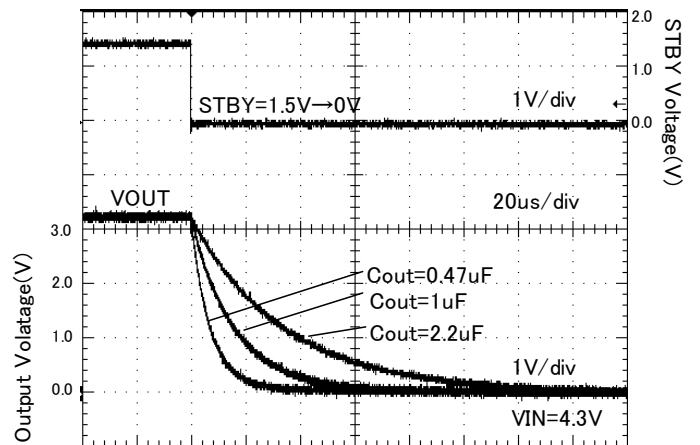

Figure 93. Discharge time (Rout = 16.5 ohm)

●Reference data BU33SA4WGWL (Unless otherwise specified, Ta=25°C, Cin = Cout =1μF.)

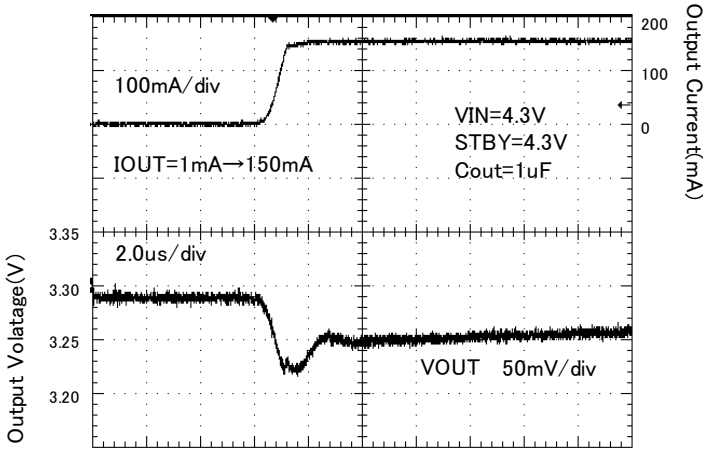

Figure 94. Load response
(Iout = 1mA → 150mA)

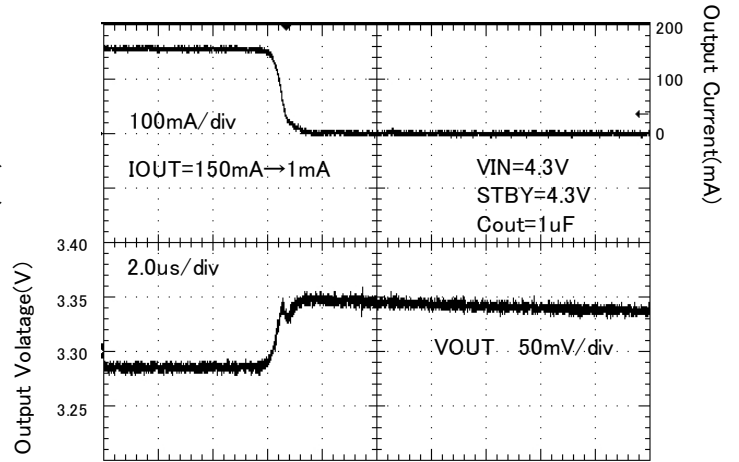

Figure 95. Load response
(Iout = 150mA → 1mA)

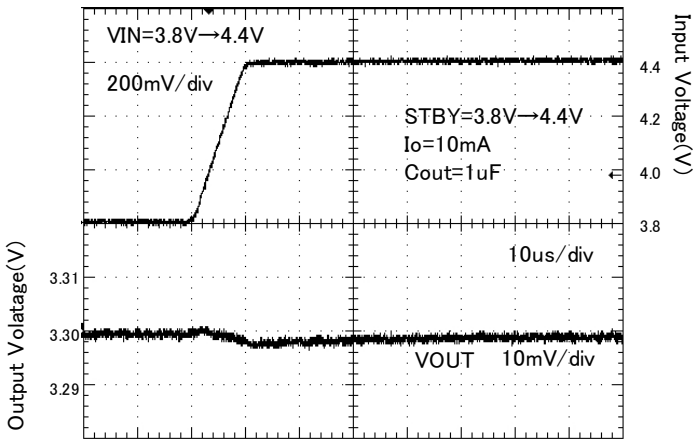

Figure 96. Line response
(Vin= 3.8 V → 4.4 V)

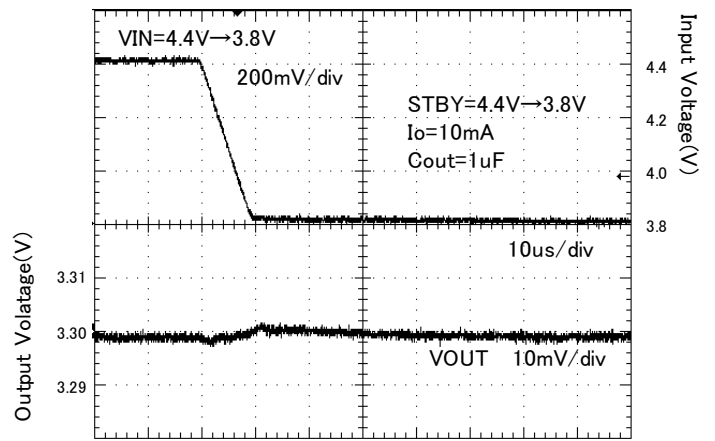

Figure 97. Line response
(Vin= 4.4 V → 3.8 V)

●Input/Output Capacitor

It is recommended that an input capacitor is placed near pins between the VCC pin and GND as well as an output capacitor between the output pin and GND. The input is valid when the power supply impedance is high or when the PCB trace has significant length. For the output capacitor, the greater the capacitance, the more stable the output will be depending on the load and line voltage variations. However, please check the actual functionality of this capacitor by mounting it on a board for the actual application. Ceramic capacitors usually have different, thermal and equivalent series resistance characteristics, and may degrade gradually over continued use.

For additional details, please check with the manufacturer, and select the best ceramic capacitor for your application

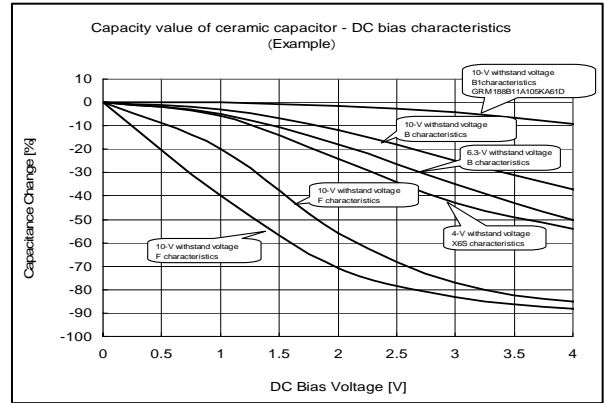

Figure 98. Capacity-bias characteristics

●Equivalent Series Resistance (ESR) of a Ceramic Capacitor

Capacitors generally have ESR (equivalent series resistance) and it operates stably in the ESR-IOUT area shown on the right. Since ceramic capacitors, tantalum capacitors, electrolytic capacitors, etc. generally have different ESR, please check the ESR of the capacitor to be used and use it within the stability area range shown in the right graph for evaluation of the actual application.

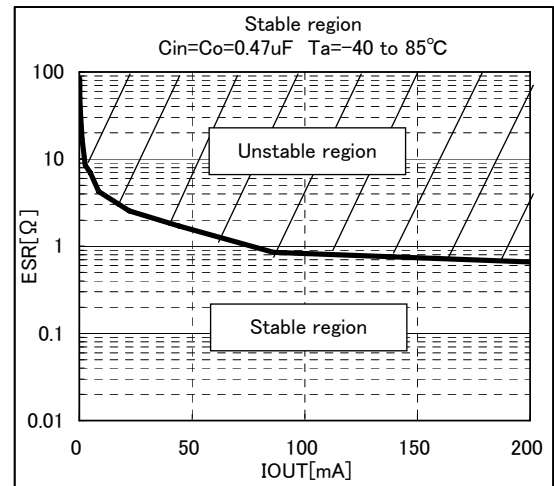

Figure 99. Stability area characteristics (Example)

●Power Dissipation (Pd)

As for power dissipation, an estimate of heat reduction characteristics and internal power consumption of IC are shown, so please use these for reference. Since power dissipation changes substantially depending on the implementation conditions (board size, board thickness, metal wiring rate, number of layers and through holes, etc.), it is recommended to measure Pd on a set board. Exceeding the power dissipation of IC may lead to deterioration of the original IC performance, such as causing the operation of the thermal shutdown circuit or reduction in current capability. Therefore, be sure to prepare sufficient margin within power dissipation for usage.

Calculation of the maximum internal power consumption of IC (P_{MAX})

$P_{MAX}=(V_{IN}-V_{OUT})\times I_{OMAX}$ Where : V_{IN} =Input voltage V_{OUT} = Output voltage I_{OMAX} : Maximum output current)

○Measurement conditions

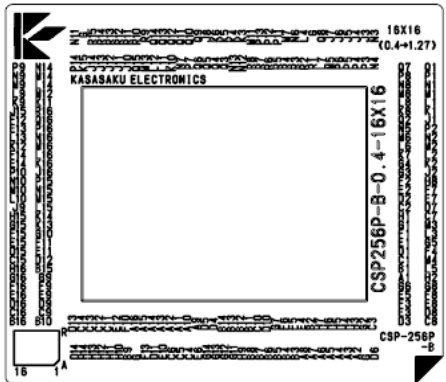
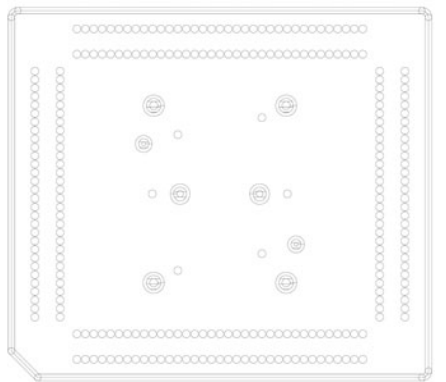
Layout of Board for Measurement	Evaluation board	
	 <p>Top Layer (Top View)</p>	 <p>Bottom Layer (Top View)</p>
Measurement State	With board implemented (Wind speed 0 m/s)	
Board Material	Glass epoxy resin (9 layers)	
Board Size	63 mm x 55 mm x 1.6 mm	
Wiring Rate	Top layer	Metal (GND) wiring rate: Approx. 0%
	Bottom layer	Metal (GND) wiring rate: Approx. 50%
Through Hole	Diameter 0.5mm x 6 holes	
Power Dissipation	0.41W	
Thermal Resistance	$\theta_{ja}=243.9^{\circ}\text{C/W}$	

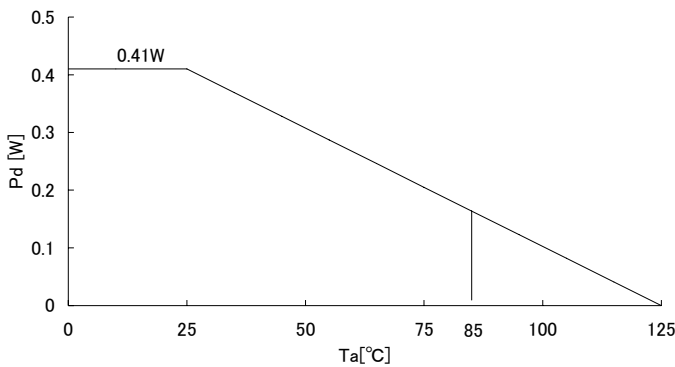

* Please design the margin so that P_{MAX} is less than Pd (P_{MAX}<Pd) within the usage temperature range

Figure 100. UCSP50L1(BUXXSA4WGWL) Power dissipation heat reduction characteristics (Reference)

● I/O Equivalence Circuits

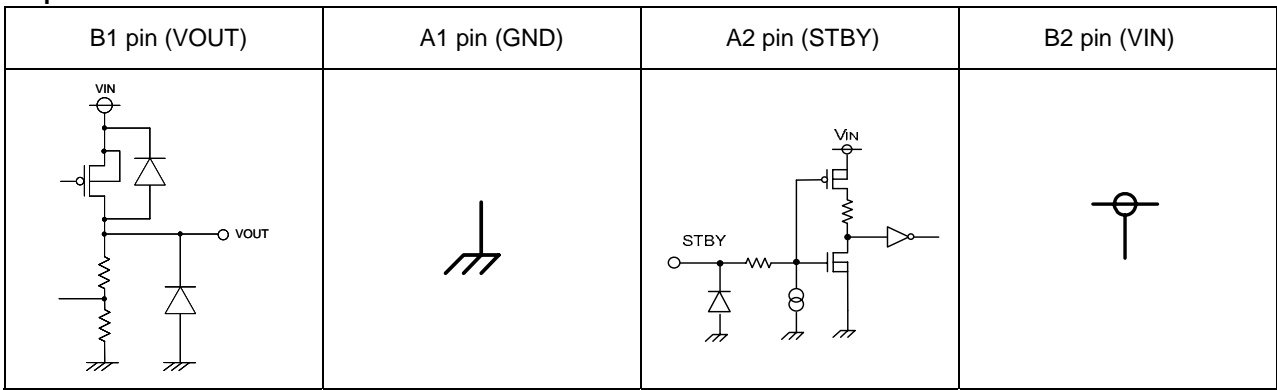

Figure 101. Input / Output equivalent circuit

●Operational Notes

- 1) Absolute maximum ratings
This product is produced with strict quality control, however it may be destroyed if operated beyond its absolute maximum ratings. In addition, it is impossible to predict all destructive situations such as short-circuit modes, open circuit modes, etc. Therefore, it is important to consider circuit protection measures, like adding a fuse, in case the IC is operated in a special mode exceeding the absolute maximum ratings.
- 2) GND Potential
GND potential must be the lowest potential of all pins of the IC at all operating conditions. Ensure that no pins are at a voltage below the ground pin at any time, even during transient condition.
- 3) Setting of Heat
Carry out the heat design that have adequate margin considering Pd of actual working states.
- 4) Pin Short and Mistake Fitting
When mounting the IC on the PCB, pay attention to the orientation of the IC. If there is mistake in the placement, the IC may be burned up.
- 5) Actions in Strong Magnetic Field
Using the IC within a strong magnetic field may cause the IC to malfunction.
- 6) Mutual Impedance
Use short and wide wiring tracks for the power supply and ground to keep the mutual impedance as small as possible. Use a capacitor to keep ripple to a minimum.
- 7) STBY Pin Voltage
To enable standby mode for all channels, set the STBY pin to 0.5 V or less, and for normal operation, to 1.1 V or more. Setting STBY to a voltage between 0.5 and 1.1 V may cause malfunction and should be avoided. Keep transition time between high and low (or vice versa) to a minimum. Additionally, if STBY is shorted to VIN, the IC will switch to standby mode and disable the output discharge circuit, causing a temporary voltage to remain on the output pin. If the IC is switched on again while this voltage is present, overshoot may occur on the output. Therefore, in applications where these pins are shorted, the output should always be completely discharged before turning the IC on.
- 8) Over Current Protection Circuit
Over current and short circuit protection is built-in at the output, and IC destruction is prevented at the time of load short circuit. These protection circuits are effective in the destructive prevention by sudden accidents, please avoid applications to where the over current protection circuit operates continuously.
- 9) Thermal Shutdown
This IC has Thermal Shutdown Circuit (TSD Circuit). When the temperature of IC Chip is higher than 175°C, the output is turned off by TSD Circuit. TSD Circuit is only designed for protecting IC from thermal over load. Therefore it is not recommended that you design application where TSD will work in normal condition.
- 10) Actions under Strong light
A strong light like a halogen lamp may be caused malfunction. In our testing, fluorescence light and white LED causes little effects for the IC, but infrared light causes strong effects on the IC. The IC should be shielded from light like sunrays or halogen lamps.
- 11) Output capacitor
To prevent oscillation at output, it is recommended that the IC be operated at the stable region shown in Figure 99. It operates at the capacitance of more than 0.47μF. As capacitance is larger, stability becomes more stable and characteristic of output load fluctuation is also improved.

●Ordering Information

B U x x S A 4 W G W L - E 2

ROHM Part No.	Output voltage xx=18:1.8V 25:2.5V 2F:2.55V 28:2.8V 30:3.0V 33:3.3V	Series name SA4W:High-speed load response Low noise Shutdown SW	Package GWL: UCSP50L1 (BUXXA4WGWL)	Packaging and forming specifications E2:Embossed tape and reel UCSP50L1(BUXXA4WGWL)
------------------	--	---	--	--

●Physical Dimension Tape and Reel Information

UCSP50L1(BUXXA4WGWL)

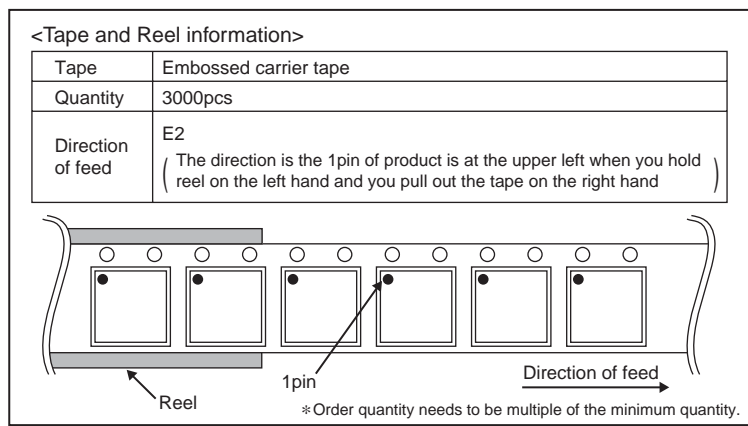
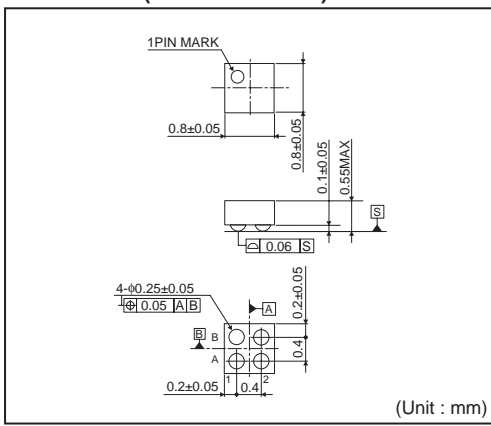

●Marking Diagram

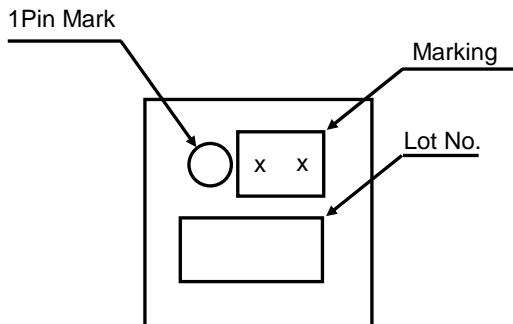

Part No.	Marking
BU18SA4WGWL	C3
BU25SA4WGWL	C9
BU2FSA4WGWL	FA
BU28SA4WGWL	E2
BU30SA4WGWL	E5
BU33SA4WGWL	E8

●Revision History

Date	Revision	Changes
04.Apr.2013	001	New Release

Notice

Precaution on using ROHM Products

- Our Products are designed and manufactured for application in ordinary electronic equipments (such as AV equipment, OA equipment, telecommunication equipment, home electronic appliances, amusement equipment, etc.). If you intend to use our Products in devices requiring extremely high reliability (such as medical equipment ^(Note 1), transport equipment, traffic equipment, aircraft/spacecraft, nuclear power controllers, fuel controllers, car equipment including car accessories, safety devices, etc.) and whose malfunction or failure may cause loss of human life, bodily injury or serious damage to property ("Specific Applications"), please consult with the ROHM sales representative in advance. Unless otherwise agreed in writing by ROHM in advance, ROHM shall not be in any way responsible or liable for any damages, expenses or losses incurred by you or third parties arising from the use of any ROHM's Products for Specific Applications.

(Note1) Medical Equipment Classification of the Specific Applications

JAPAN	USA	EU	CHINA
CLASS III	CLASS III	CLASS II b	CLASS III
CLASS IV		CLASS III	

- ROHM designs and manufactures its Products subject to strict quality control system. However, semiconductor products can fail or malfunction at a certain rate. Please be sure to implement, at your own responsibilities, adequate safety measures including but not limited to fail-safe design against the physical injury, damage to any property, which a failure or malfunction of our Products may cause. The following are examples of safety measures:
 - Installation of protection circuits or other protective devices to improve system safety
 - Installation of redundant circuits to reduce the impact of single or multiple circuit failure
- Our Products are designed and manufactured for use under standard conditions and not under any special or extraordinary environments or conditions, as exemplified below. Accordingly, ROHM shall not be in any way responsible or liable for any damages, expenses or losses arising from the use of any ROHM's Products under any special or extraordinary environments or conditions. If you intend to use our Products under any special or extraordinary environments or conditions (as exemplified below), your independent verification and confirmation of product performance, reliability, etc. prior to use, must be necessary:
 - Use of our Products in any types of liquid, including water, oils, chemicals, and organic solvents
 - Use of our Products outdoors or in places where the Products are exposed to direct sunlight or dust
 - Use of our Products in places where the Products are exposed to sea wind or corrosive gases, including Cl₂, H₂S, NH₃, SO₂, and NO₂
 - Use of our Products in places where the Products are exposed to static electricity or electromagnetic waves
 - Use of our Products in proximity to heat-producing components, plastic cords, or other flammable items
 - Sealing or coating our Products with resin or other coating materials
 - Use of our Products without cleaning residue of flux (even if you use no-clean type fluxes, cleaning residue of flux is recommended); or Washing our Products by using water or water-soluble cleaning agents for cleaning residue after soldering
 - Use of the Products in places subject to dew condensation
- The Products are not subject to radiation-proof design.
- Please verify and confirm characteristics of the final or mounted products in using the Products.
- In particular, if a transient load (a large amount of load applied in a short period of time, such as pulse. is applied, confirmation of performance characteristics after on-board mounting is strongly recommended. Avoid applying power exceeding normal rated power; exceeding the power rating under steady-state loading condition may negatively affect product performance and reliability.
- De-rate Power Dissipation (Pd) depending on Ambient temperature (Ta). When used in sealed area, confirm the actual ambient temperature.
- Confirm that operation temperature is within the specified range described in the product specification.
- ROHM shall not be in any way responsible or liable for failure induced under deviant condition from what is defined in this document.

Precaution for Mounting / Circuit board design

- When a highly active halogenous (chlorine, bromine, etc.) flux is used, the residue of flux may negatively affect product performance and reliability.
- In principle, the reflow soldering method must be used; if flow soldering method is preferred, please consult with the ROHM representative in advance.

For details, please refer to ROHM Mounting specification

Precautions Regarding Application Examples and External Circuits

1. If change is made to the constant of an external circuit, please allow a sufficient margin considering variations of the characteristics of the Products and external components, including transient characteristics, as well as static characteristics.
2. You agree that application notes, reference designs, and associated data and information contained in this document are presented only as guidance for Products use. Therefore, in case you use such information, you are solely responsible for it and you must exercise your own independent verification and judgment in the use of such information contained in this document. ROHM shall not be in any way responsible or liable for any damages, expenses or losses incurred by you or third parties arising from the use of such information.

Precaution for Electrostatic

This Product is electrostatic sensitive product, which may be damaged due to electrostatic discharge. Please take proper caution in your manufacturing process and storage so that voltage exceeding the Products maximum rating will not be applied to Products. Please take special care under dry condition (e.g. Grounding of human body / equipment / solder iron, isolation from charged objects, setting of Ionizer, friction prevention and temperature / humidity control).

Precaution for Storage / Transportation

1. Product performance and soldered connections may deteriorate if the Products are stored in the places where:
 - [a] the Products are exposed to sea winds or corrosive gases, including Cl₂, H₂S, NH₃, SO₂, and NO₂
 - [b] the temperature or humidity exceeds those recommended by ROHM
 - [c] the Products are exposed to direct sunshine or condensation
 - [d] the Products are exposed to high Electrostatic
2. Even under ROHM recommended storage condition, solderability of products out of recommended storage time period may be degraded. It is strongly recommended to confirm solderability before using Products of which storage time is exceeding the recommended storage time period.
3. Store / transport cartons in the correct direction, which is indicated on a carton with a symbol. Otherwise bent leads may occur due to excessive stress applied when dropping of a carton.
4. Use Products within the specified time after opening a humidity barrier bag. Baking is required before using Products of which storage time is exceeding the recommended storage time period.

Precaution for Product Label

QR code printed on ROHM Products label is for ROHM's internal use only.

Precaution for Disposition

When disposing Products please dispose them properly using an authorized industry waste company.

Precaution for Foreign Exchange and Foreign Trade act

Since our Products might fall under controlled goods prescribed by the applicable foreign exchange and foreign trade act, please consult with ROHM representative in case of export.

Precaution Regarding Intellectual Property Rights

1. All information and data including but not limited to application example contained in this document is for reference only. ROHM does not warrant that foregoing information or data will not infringe any intellectual property rights or any other rights of any third party regarding such information or data. ROHM shall not be in any way responsible or liable for infringement of any intellectual property rights or other damages arising from use of such information or data.:
2. No license, expressly or implied, is granted hereby under any intellectual property rights or other rights of ROHM or any third parties with respect to the information contained in this document.

Other Precaution

1. This document may not be reprinted or reproduced, in whole or in part, without prior written consent of ROHM.
2. The Products may not be disassembled, converted, modified, reproduced or otherwise changed without prior written consent of ROHM.
3. In no event shall you use in any way whatsoever the Products and the related technical information contained in the Products or this document for any military purposes, including but not limited to, the development of mass-destruction weapons.
4. The proper names of companies or products described in this document are trademarks or registered trademarks of ROHM, its affiliated companies or third parties.

General Precaution

1. Before you use our Products, you are requested to carefully read this document and fully understand its contents. ROHM shall not be in any way responsible or liable for failure, malfunction or accident arising from the use of any ROHM's Products against warning, caution or note contained in this document.
2. All information contained in this document is current as of the issuing date and subject to change without any prior notice. Before purchasing or using ROHM's Products, please confirm the latest information with a ROHM sales representative.
3. The information contained in this document is provided on an "as is" basis and ROHM does not warrant that all information contained in this document is accurate and/or error-free. ROHM shall not be in any way responsible or liable for any damages, expenses or losses incurred by you or third parties resulting from inaccuracy or errors of or concerning such information.

X-ON Electronics

Largest Supplier of Electrical and Electronic Components

Click to view similar products for [LDO Voltage Regulators](#) category:

Click to view products by [ROHM](#) manufacturer:

Other Similar products are found below :

[AP7363-SP-13](#) [L79M05TL-E](#) [PT7M8202B12TA5EX](#) [TCR3DF185,LM\(CT](#) [TCR3DF24,LM\(CT](#) [TCR3DF285,LM\(CT](#) [TCR3DF31,LM\(CT](#)
[TCR3DF45,LM\(CT](#) [MP2013GQ-33-Z](#) [059985X](#) [NCP4687DH15T1G](#) [701326R](#) [TCR2EN28,LF\(S](#) [NCV8170AXV250T2G](#)
[TCR3DF27,LM\(CT](#) [TCR3DF19,LM\(CT](#) [TCR3DF125,LM\(CT](#) [TCR2EN18,LF\(S](#) [AP2112R5A-3.3TRG1](#) [AP7315-25W5-7](#)
[IFX30081LDVGRNXUMA1](#) [NCV47411PAAJR2G](#) [AP2113KTR-G1](#) [AP2111H-1.2TRG1](#) [ZLDO1117QK50TC](#) [AZ1117IH-1.8TRG1](#)
[AZ1117ID-ADJTRG1](#) [TCR3DG12,LF](#) [MIC5514-3.3YMT-T5](#) [MIC5512-1.2YMT-T5](#) [MIC5317-2.8YM5-T5](#) [SCD7912BTG](#)
[NCP154MX180270TAG](#) [SCD33269T-5.0G](#) [NCV8170BMX330TCG](#) [NCV8170AMX120TCG](#) [NCP706ABMX300TAG](#)
[NCP153MX330180TCG](#) [NCP114BMX075TCG](#) [MC33269T-3.5G](#) [CAT6243-ADJCMT5T](#) [TCR3DG33,LF](#) [AP2127N-1.0TRG1](#)
[TCR4DG35,LF](#) [LT1117CST-3.3](#) [LT1117CST-5](#) [TAR5S15U\(TE85L,F\)](#) [TAR5S18U\(TE85L,F\)](#) [TCR3UG19A,LF](#) [TCR4DG105,LF](#)