

1.8V to 5.5V, 300mA 1ch Synchronous Boost DC/DC Converter

BU34DV7NUX

•General Description

The BU34DV7NUX devices provide a power supply solution for products powered by either two-cell alkaline, NiCd or NiMH, or one-cell Li-ion or Li-polymer battery.

Output currents can go as high as 300mA while using two alkaline, and discharge it down to 1.8 V.

With the MODE pin, the BU34DV7NUX provides mode selection of PWM control or PFM/PWM automatic switching control. When load current is large, the product switches automatically to the PWM mode so that high efficiency is achievable over a wide range of load conditions. The maximum peak current in the boost switch is typically limited to a value of 1.85A.

BU34DV7NUX output voltage is fixed by an internal resistor divider. When VIN voltage is higher than 3.4 V, Vout is connected with Vin.

•Features

- Synchronous Boost DC/DC Converter(PFM/PWM)
300mA @Vout=3.4V, Vin=1.8V
- Fixed Output voltage (3.4V)
- Pass-Through Function1 (VIN > VOUT<3.4V>)
- Thermal Shutdown
- VSON010X3030 (Small Package)

•Key Specifications

■ Input voltage range:	1.8V to 5.5V
■ Output Voltage range:	3.33V to 3.47V
■ Output current:	300mA (Max.)
■ Switching frequency:	0.6MHz (Typ.)
■ Pch FET ON resistance:	160mΩ (Typ.)
■ Nch FET ON resistance:	90mΩ (Typ.)
■ Standby current (MODE=0V):	4.5μA (Max.)
■ Standby current (MODE=VIN):	1.5μA (Max.)
■ Operating temperature range:	-40°Cto+85°C

<Available Features with MODE=0V>

- Pass-Through Function2 during EN-OFF
- Disconnect Function during UVLO
- UVLO-detect Voltage:1.8V(typ)
- UVLO-release Voltage:2.0V(typ)
- PWM(Switching Frequency 600kHz)

<Available Features with MODE=VIN>

- Disconnect Function during EN-OFF and UVLO
- UVLO-detect Voltage:1.8V(typ)
- UVLO-release Voltage:2.0V(typ)
- PFM/PWM(Switching Frequency to 600kHz)

•Applications

- Two-Cell Alkaline, NiCd or NiMH or Single-Cell Li Battery-Powered Products
- Portable Audio Players
- PDA
- Cellular Phones
- Personal Medical Products

•Package

10-pin small "VSON010X3030" package.
<3.1mm (Typ.) x 3.1mm (Typ.) x 0.6mm (Max.)>

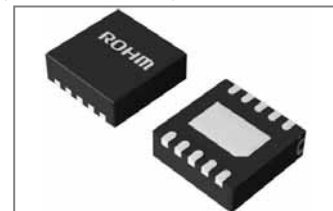

VSON010X3030

•Typical Application Circuit

[] Necessary at PFM

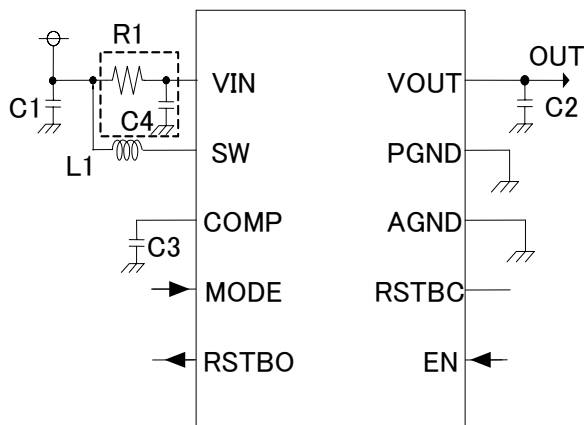

Figure 1. Application Circuit

•Typical Performance characteristics

Efficiency T_{emp}=25°C

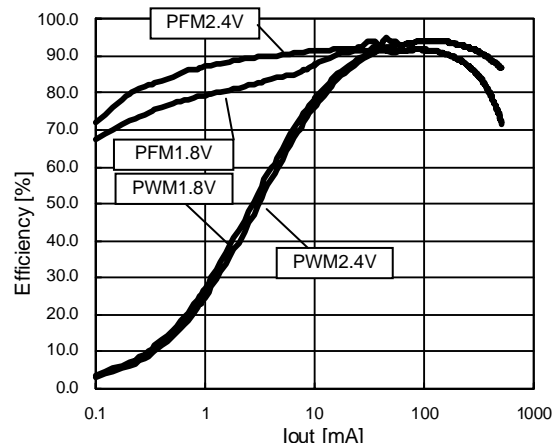

Figure 2. Efficiency

●Absolute maximum ratings(Ta=25°C)

Parameter	Symbol	Ratings	Unit	Condition
Maximum applied voltage	Vmax	7.0	V	
Power dissipation1	Pd1	464 (Note1)	mW	1layer(74.2x74.2mm)board (Surface heat radiation copper foil: 6.28mm ²)
Power dissipation2	Pd2	1440 (Note2)	mW	4layer(74.2x74.2mm)board (1,4layer heat radiation copper foil: 6.28mm ²) (2,3layer heat radiation copper foil: 5500mm ²)
Operating temperature range	Topr	-40 to +85	°C	
Storage temperature range	Tstr	-55 to +125	°C	

*1 When it is used by more than Ta=25°C, it is reduced by 4.64mW/°C.

*2 When it is used by more than Ta=25°C, it is reduced by 14.4mW/°C.

●Operating conditions

Parameter	Symbol	Ratings	Unit	Condition
Power supply voltage range	VCC	1.8 to 5.5	V	VIN terminal voltage

●Electrical characteristics [BU34DV7NUX]

(Unless otherwise specified Ta=25°C、VIN=2.4V)

Parameter	Symbol	Min.	Typ.	Max.	Unit	Condition
Circuit current1(EN=0V)	ICC1A	-	1.6	4.5	μA	EN=0V,MODE=0V
Circuit current2(EN=0V)	ICC2A	-	0.3	1.5	μA	EN=0V,MODE=VIN
Circuit current1 no switching (EN=VIN,VOUT=5V)	ICC1B	-	140	250	μA	EN=VIN,MODE=0V, VOUT=5.0V (not include SW)
Circuit current2 no switching (EN=VIN,VOUT=5V)	ICC2B	-	25	50	μA	EN=VIN,MODE=VIN, VOUT=5.0V (not include SW)
Circuit current1(EN=VIN)	ICC1C	-	3.5	-	mA	EN=VIN,MODE=0V, I _o =0mA
Circuit current2(EN=VIN)	ICC2C	-	30	-	μA	EN=VIN,MODE=VIN, I _o =0mA
Oscillation frequency	Fsw	0.5	0.6	0.7	MHz	
Output voltage range	Vout	3.33	3.4	3.47	V	I _o =1mA
Current limit	Ilim	1.4	1.85	2.2	A	DC - Current
EN Input High	VIH_EN	0.9	-	-	V	
EN Input Low	VIL_EN	-	-	0.2	V	
MODE Input High	VIH_MODE	0.9	-	-	V	
MODE Input Low	VIL_MODE	-	-	0.2	V	
RSTBO output low voltage	Vrstol	-	0.1	0.2	V	I _{oi} =100uA,MODE=0V
RSTBO output high voltage	Vrstoh	VIN-0.2	VIN-0.1	-	V	I _{oi} =-100uA,MODE=0V
RSTBC output resistance	Rrstbc	450	600	750	kΩ	
SWN1 switch on resistance	Rswn1	-	90	-	mΩ	VOUT=3.4V
SWP1 switch on resistance	Rswp1	-	160	-	mΩ	
SWN2 switch on resistance	Rswn2	-	1.0	-	kΩ	MODE=VIN,EN=0V
SWP2 switch on resistance	Rswp2	-	60	-	Ω	MODE=0V,EN=0V
UVLO Release Threshold	VuvloR	1.9	2.0	2.1	V	VIN rising
UVLO Detect Threshold	VuvloD	1.75	1.8	1.85	V	VIN falling
UVLO Hysteresis	Vuvlohys	-	0.2	-	V	
VIN Thru	Vinthru	3.3	3.4	3.5	V	
VIN Thru Hysteresis	Vinthruhys	20	50	80	mV	

●Block diagram

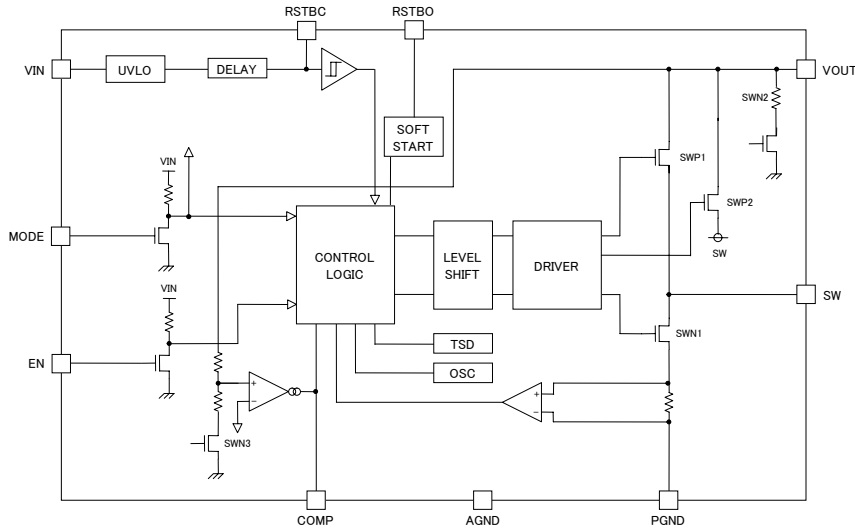

Figure 3. Circuit Block

●MODE

INPUT PIN		FUNCTION				SW-ON/OFF				
MODE PIN	EN PIN	UVLO	UVLO RELEASE VOLTAGE	DC/DC-control PWM or PFM/PWM	RSTBO	SWP2	SWN2	SWN3	SWP1	SWN1
0V	0V	ON	2.0V(typ)	-	0V	ON	OFF	OFF	OFF	OFF
0V	VIN	ON	2.0V(typ)	PWM	While Soft Start : 0V After Soft Start : VIN	OFF	OFF	ON	Switching	Switching
VIN	0V	OFF	-	-	0V	OFF	ON	OFF	OFF	OFF
VIN	VIN	ON	2.0V(typ)	PFM/PWM	While Soft Start : 0V After Soft Start : VIN	OFF	OFF	ON	Switching	Switching

●Pin Configuration

Symbol	Pin No.	Function	Terminal circuit
VIN	1	Power supply input	C
SW	2	Inductor connection terminal	C
COMP	3	Phase Compensation Pin	A
MODE	4	Function Select Pin	C
RSTBO	5	Soft Start Output Pin While Soft Start : LOW(GND) After Soft Start : High(VIN)	A
EN	6	EN=VIN: Power-ON EN=GND: Power-OFF	C
RSTBC	7	Low Battery Detect Delay Pin	A
AGND	8	GND	B
PGND	9	GND	B
VOUT	10	Boost voltage output Pin	C

※ Don't use EN PIN and MODE PIN at open.

VSON010X3030

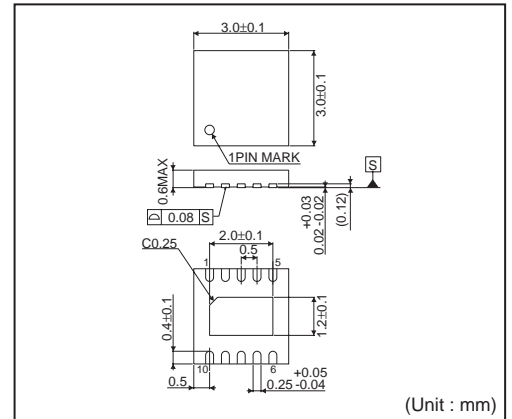
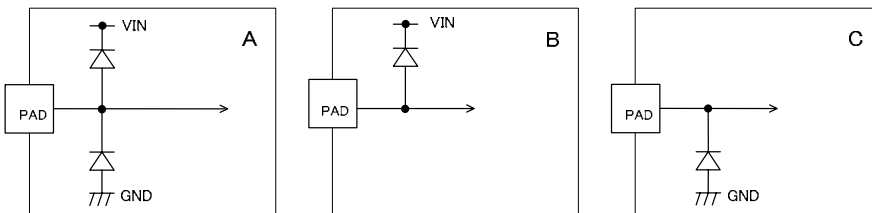

Figure 4. Package

●Input-Output Equivalent Circuit

I/O equivalent circuit diagram is as follows.



•Electrical characteristic curves (Reference data)

• Quiescent Current

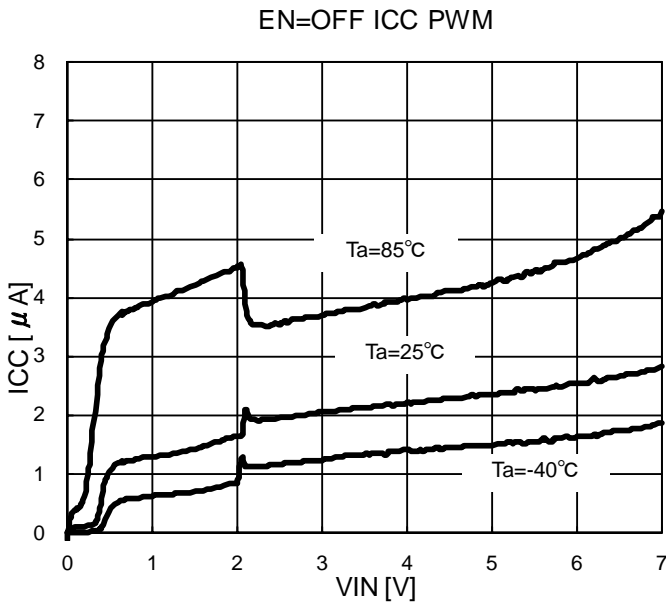

Figure 5. Quiescent Current PWM

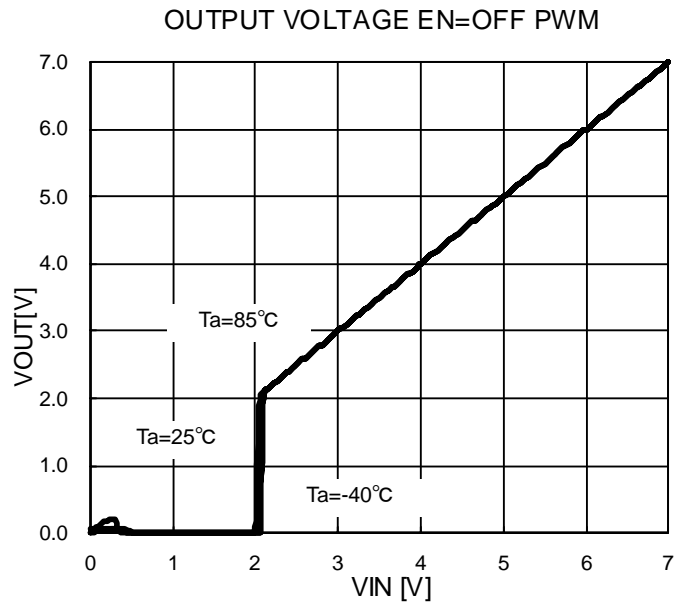

Figure 6. Out Put Voltage (EN=OFF) PWM

•Electrical characteristic curves (Reference data) - Continued

• Quiescent Current - Continued

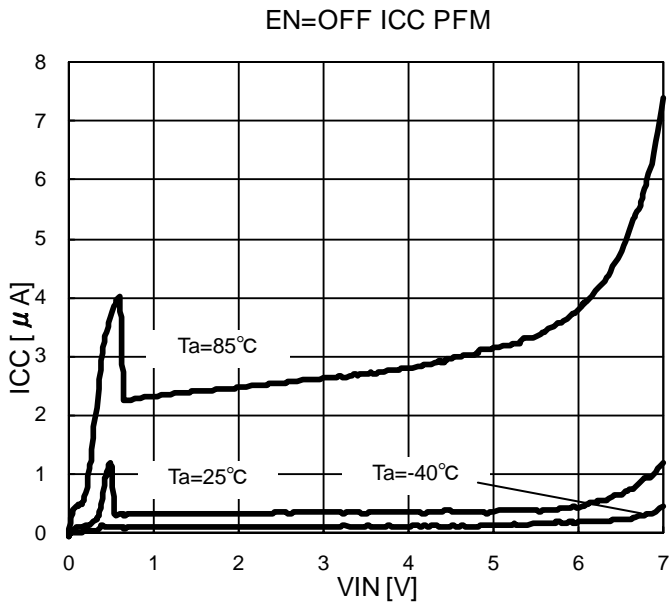

Figure 7. Quiescent Current PFM

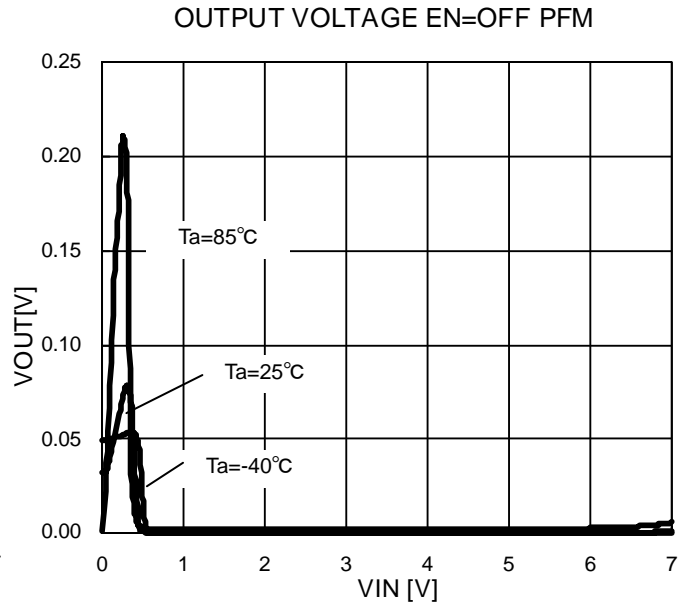

Figure 8. Out Put Voltage (EN=OFF) PFM

• Frequency

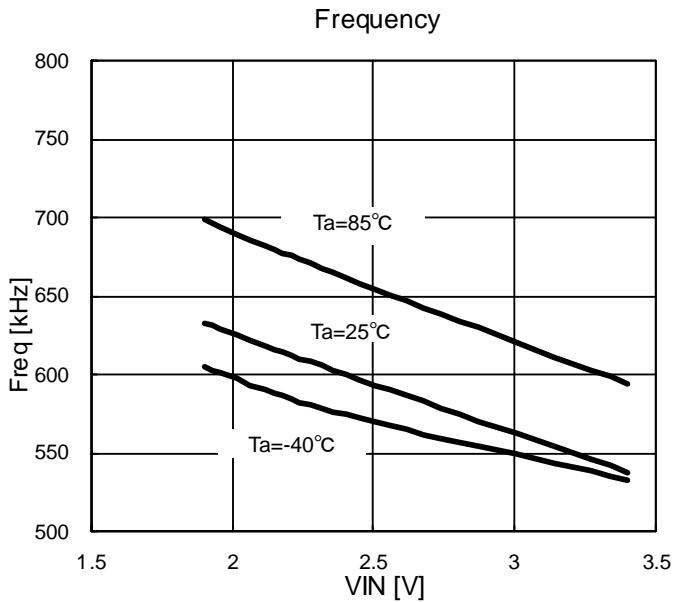

Figure 9. Frequency

•Electrical characteristic curves (Reference data) - Continued

• Efficiency

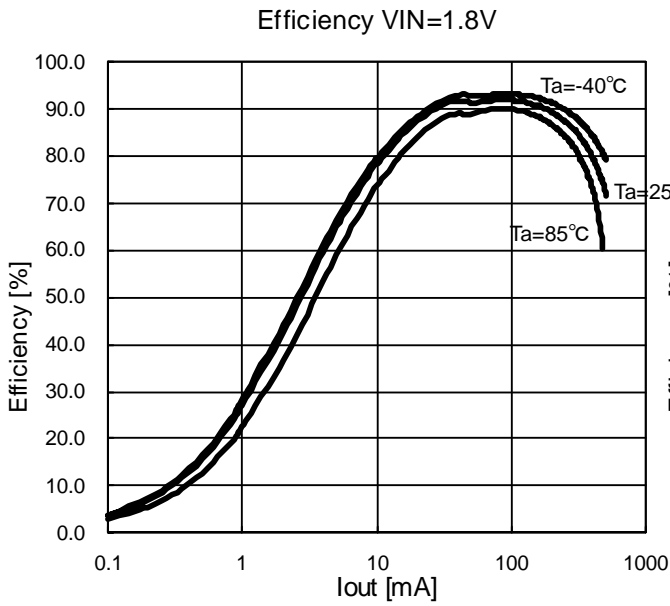

Figure 10. Efficiency PWM VIN=1.8V

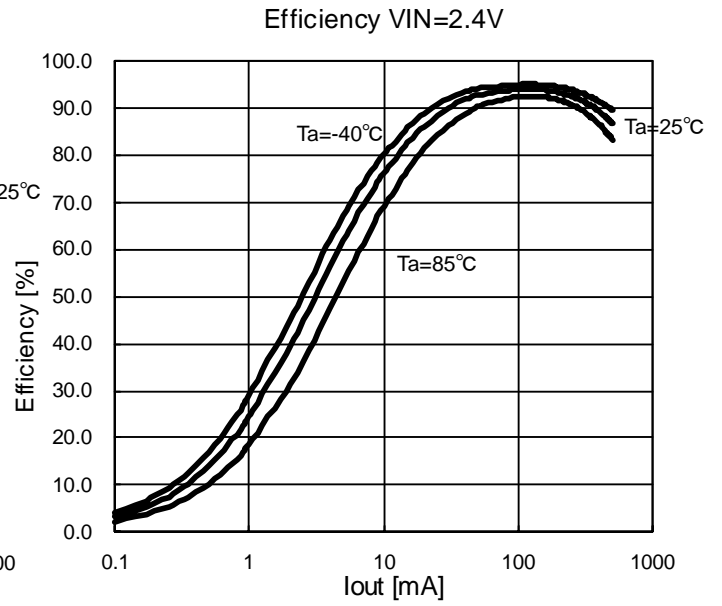

Figure 11. Efficiency PWM VIN=2.4V

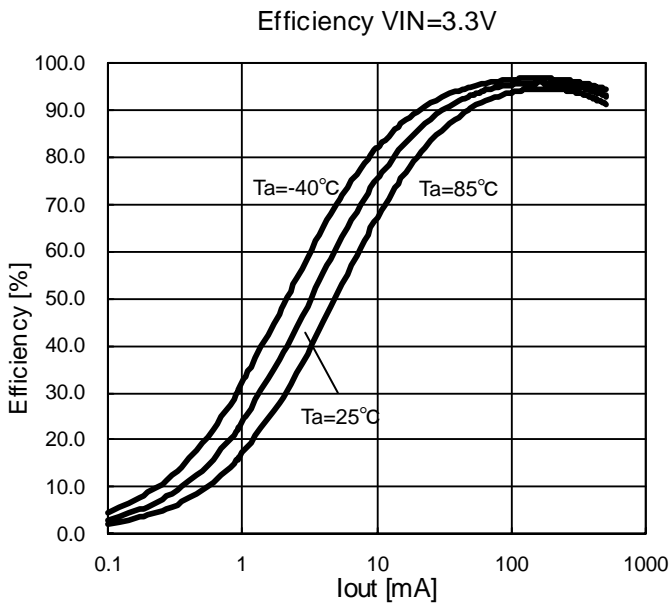

Figure 12. Efficiency PWM VIN=3.3V

•Electrical characteristic curves (Reference data) - Continued

• Efficiency - Continued

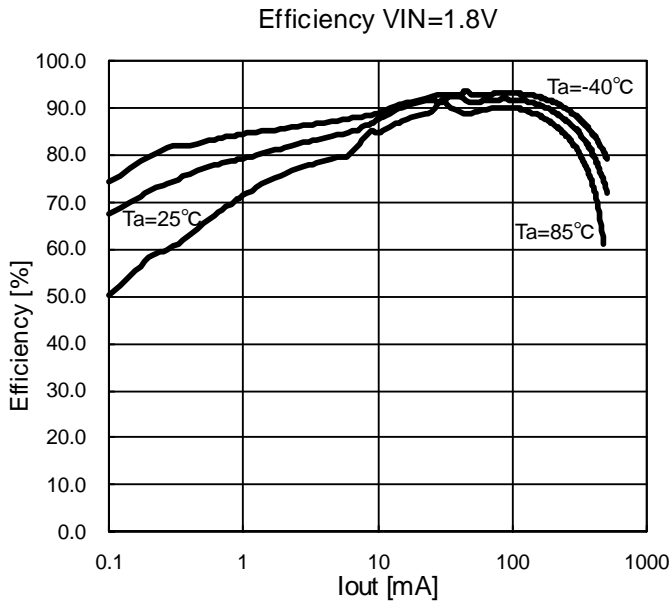

Figure 13. Efficiency PFM VIN=1.8V

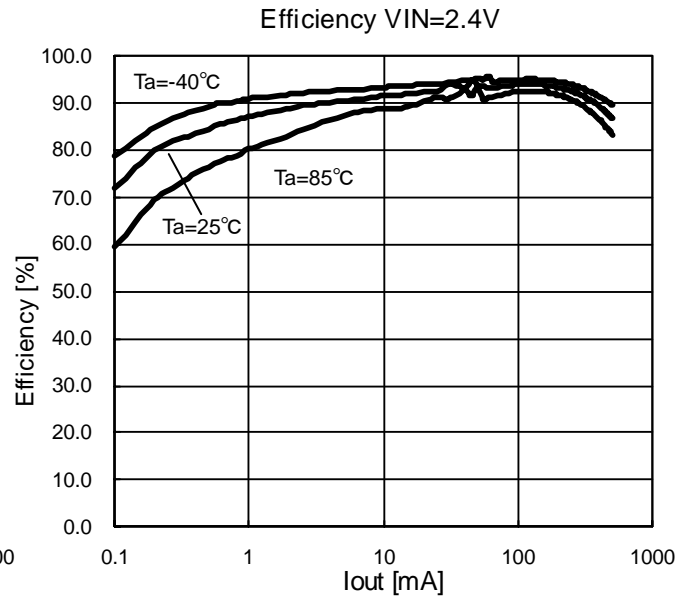

Figure 14. Efficiency PFM VIN=2.4V

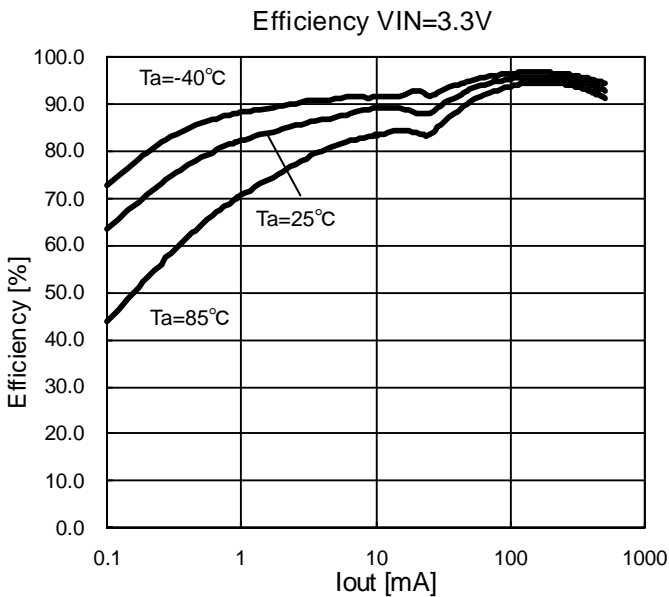

Figure 15. Efficiency PFM VIN=3.3V

•Electrical characteristic curves (Reference data) - Continued

• Load Regulation

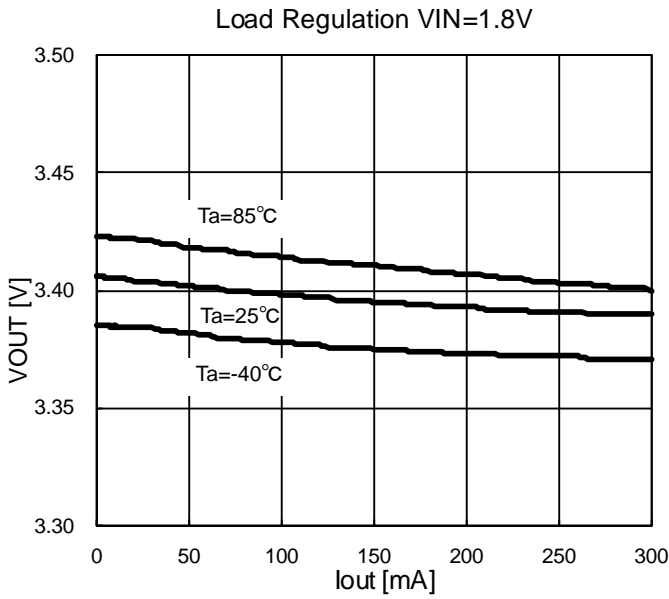

Figure 16. Load Regulation PWM VIN=1.8V

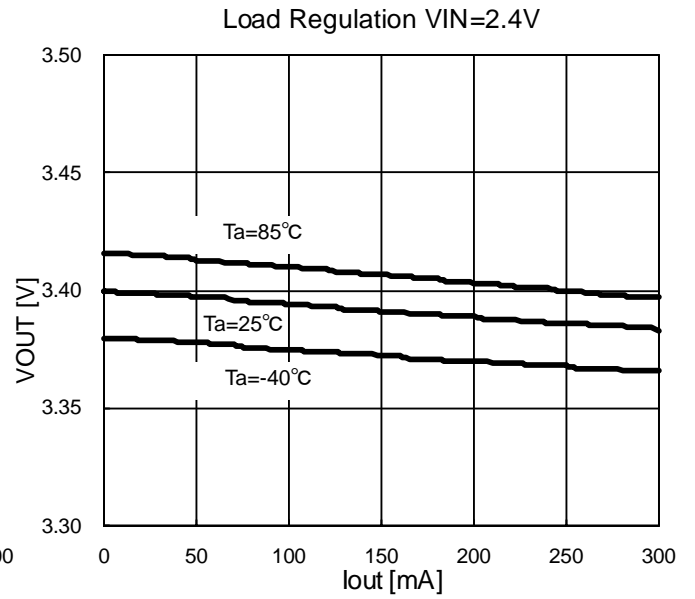

Figure 17. Load Regulation PWM VIN=2.4V

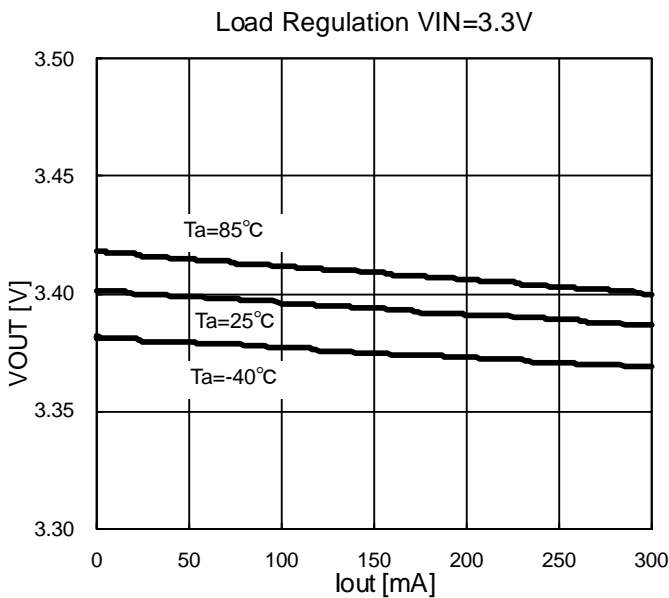

Figure 18. Load Regulation PWM VIN=3.3V

•Electrical characteristic curves (Reference data) – Continued

• Load Regulation - Continued

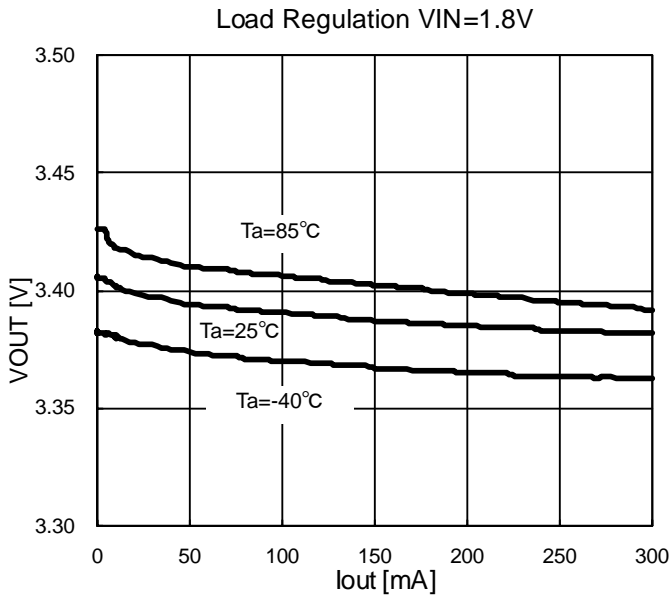

Figure 19. Load Regulation PFM VIN=1.8V

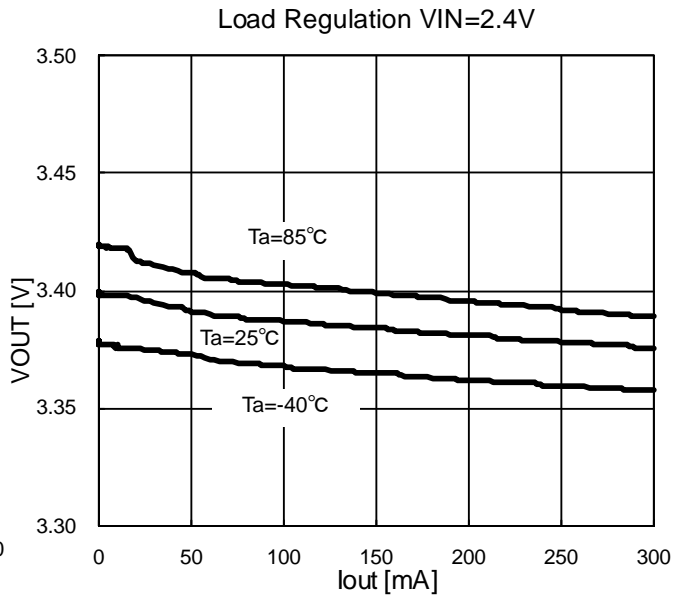

Figure 20. Load Regulation PFM VIN=2.4V

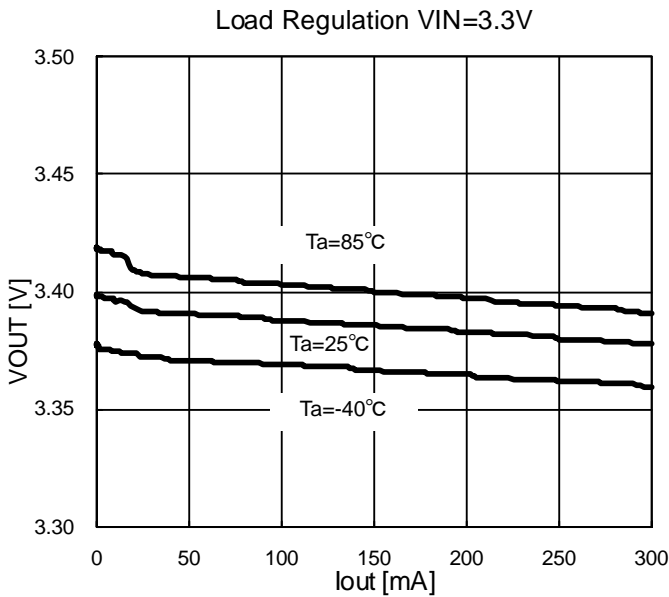

Figure 21. Load Regulation PFM VIN=3.3V

•Electrical characteristic curves (Reference data) - Continued

• Rise

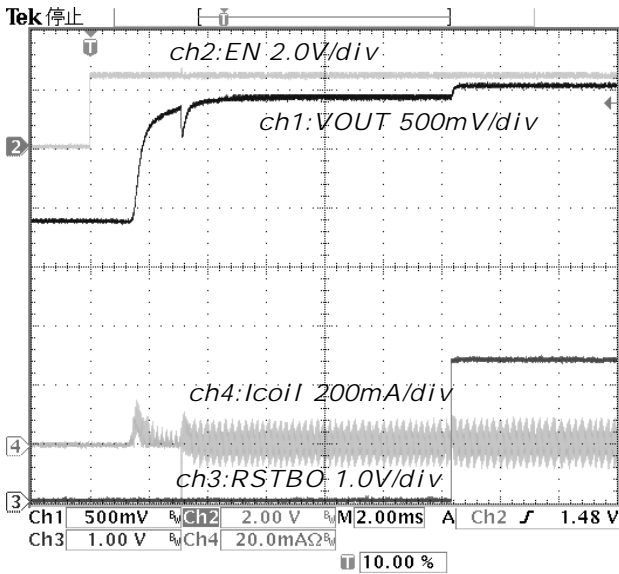

Figure 22. RISE [EN : OFF=>ON] PWM
VIN=2.4V Io=0mA

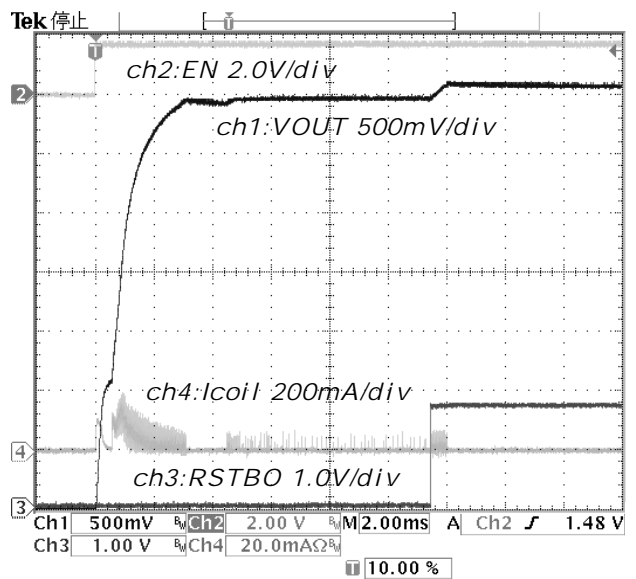

Figure 23. RISE [EN : OFF=>ON] PFM
VIN=2.4V Io=0mA

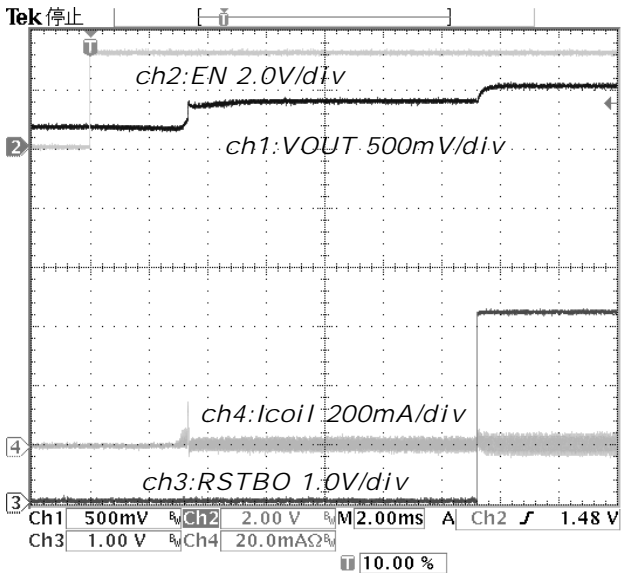

Figure 24. RISE [EN : OFF=>ON] PWM
VIN=3.3V Io=0mA

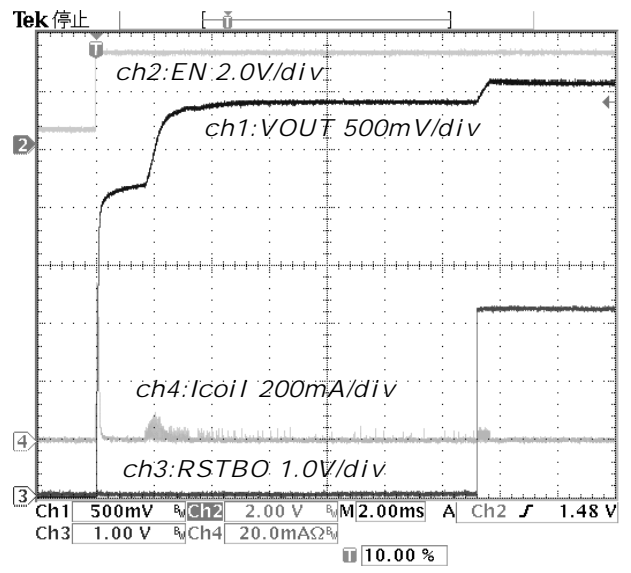

Figure 25. RISE [EN : OFF=>ON] PFM
VIN=3.3V Io=0mA

•Electrical characteristic curves (Reference data) - Continued

• Rise - Continued

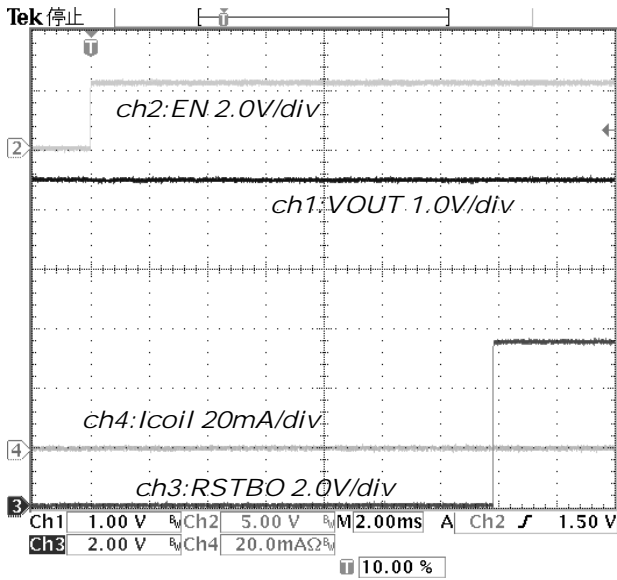

Figure 26. RISE [EN : OFF=>ON] PWM
VIN=5.5V Io=0mA

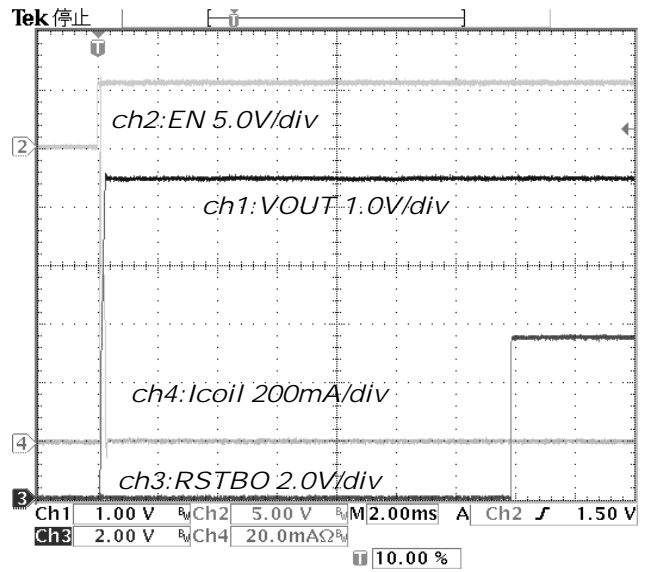

Figure 27. RISE [EN : OFF=>ON] PFM
VIN=5.5V Io=0mA

•Electrical characteristic curves (Reference data) - Continued

• Fall

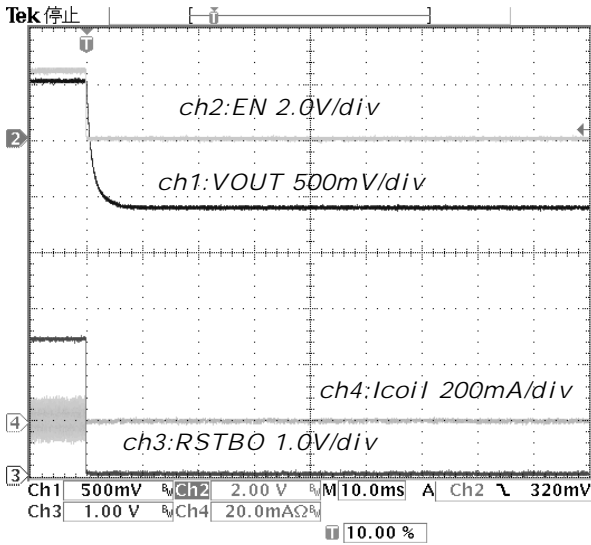

Figure 28. FALL [EN : ON=>OFF] PWM
VIN=2.4V Io=0mA

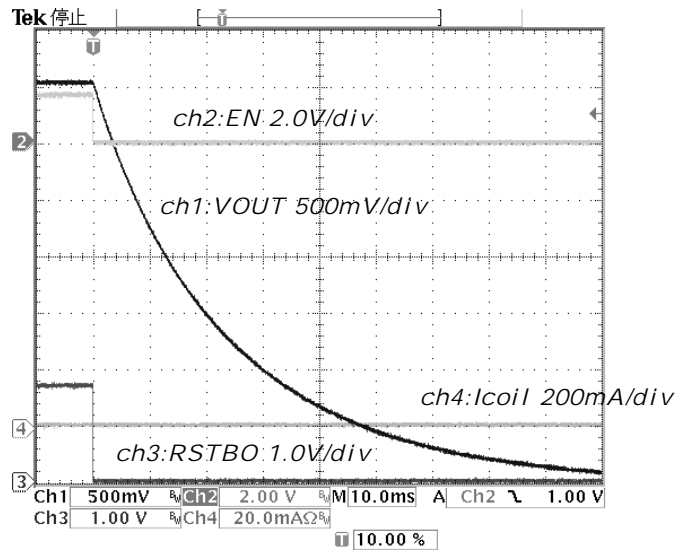

Figure 29. FALL [EN : ON=>OFF] PFM
VIN=2.4V Io=0mA

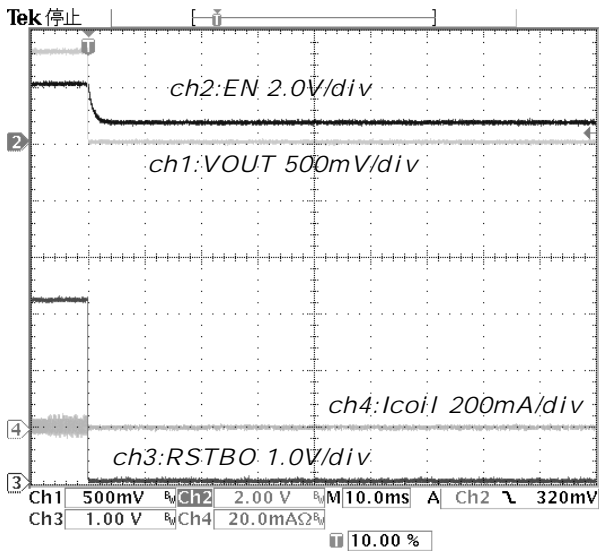

Figure 30. FALL [EN : ON=>OFF] PWM
VIN=3.3V Io=0mA

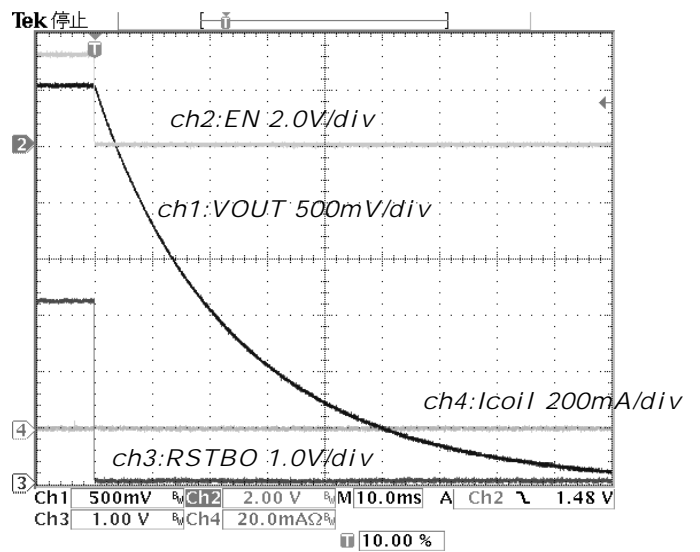

Figure 31. FALL [EN : ON=>OFF] PFM
VIN=3.3V Io=0mA

•Electrical characteristic curves (Reference data) – Continued

• Fall - Continued

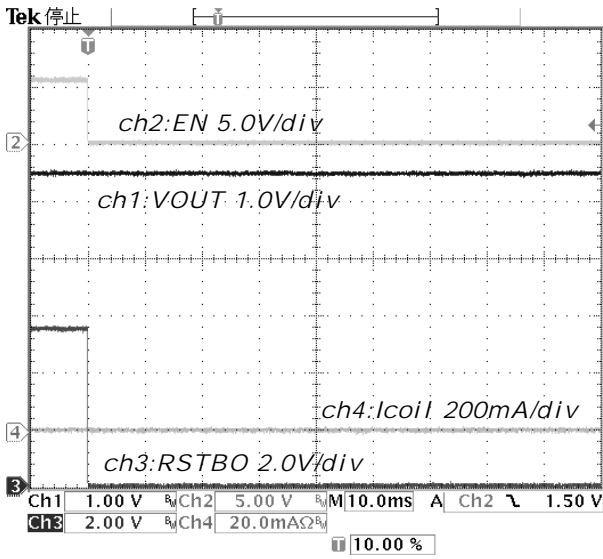

Figure 32. FALL [EN : ON=>OFF] PWM
VIN=5.5V Io=0mA

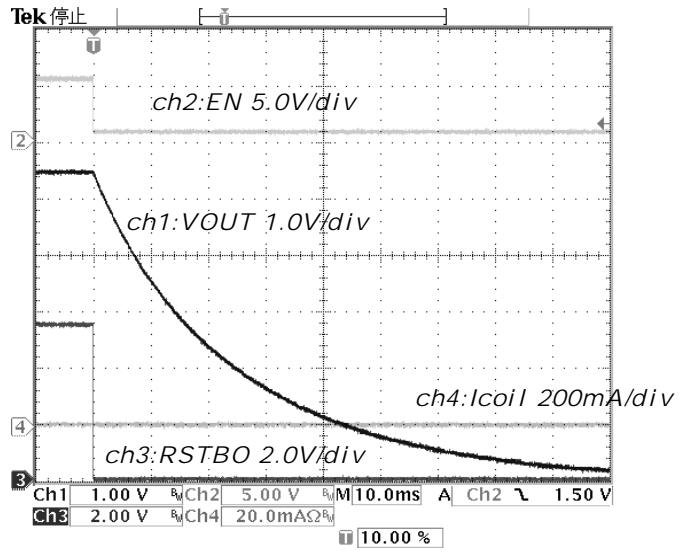

Figure 33. FALL [EN : ON=>OFF] PFM
VIN=5.5V Io=0mA

•Electrical characteristic curves (Reference data) - Continued

• I_o change PWM

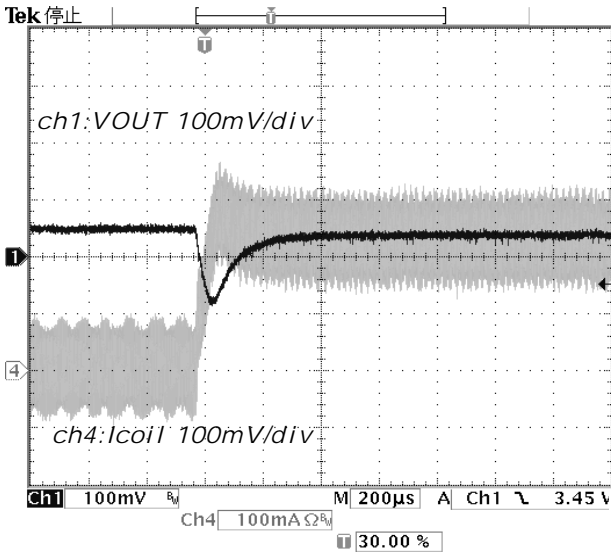

Figure 34. I_o change PWM 1mA=>100mA
VIN=1.8V

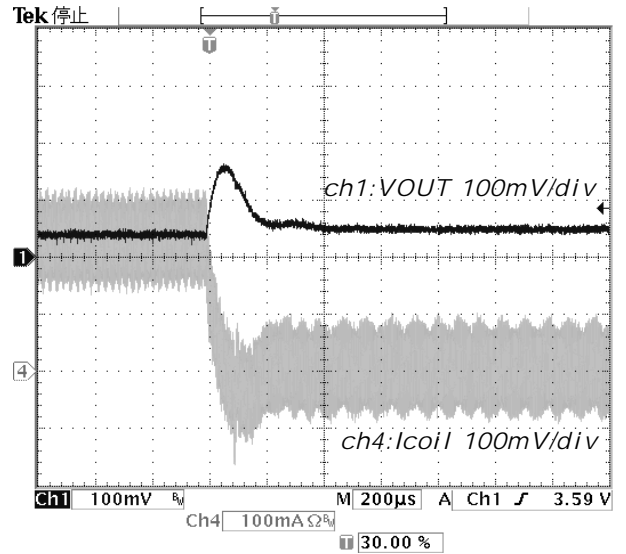

Figure 35. I_o change PWM 100mA=>1mA
VIN=1.8V

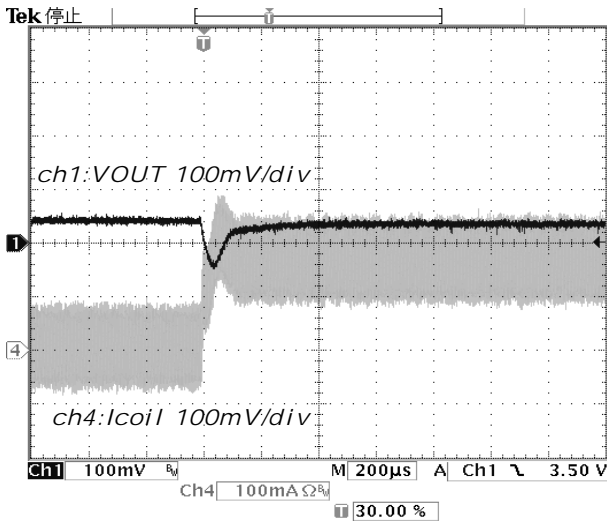

Figure 36. I_o change PWM 1mA=>100mA
VIN=2.4V

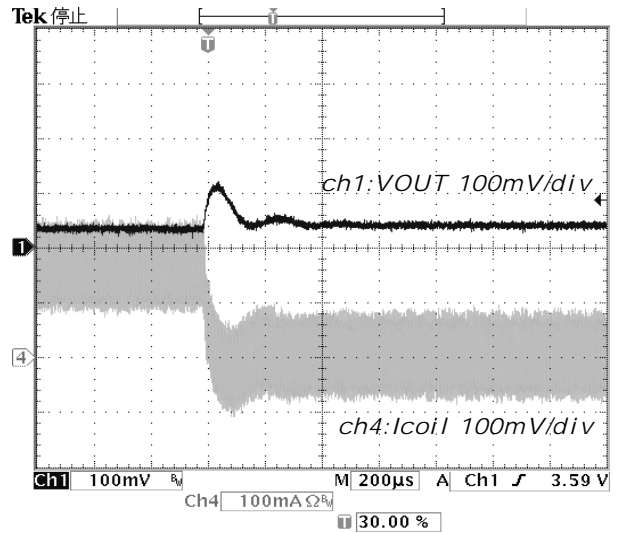

Figure 37. I_o change PWM 100mA=>1mA
VIN=2.4V

•Electrical characteristic curves (Reference data) – Continued

• Io change PWM - Continued

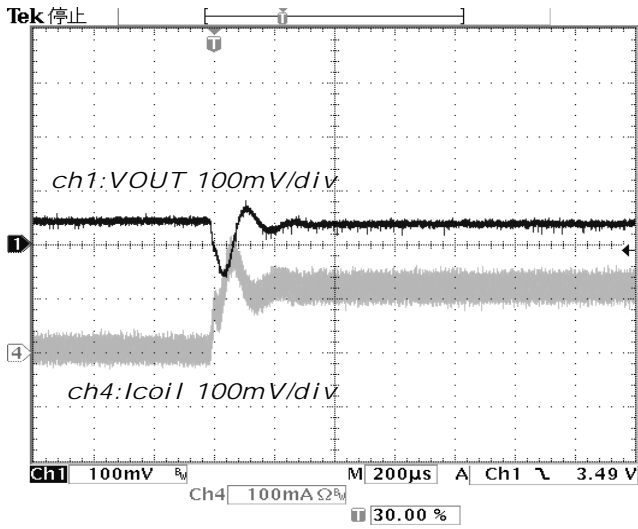

Figure 38. Io change PWM 1mA=>100mA
VIN=3.3V

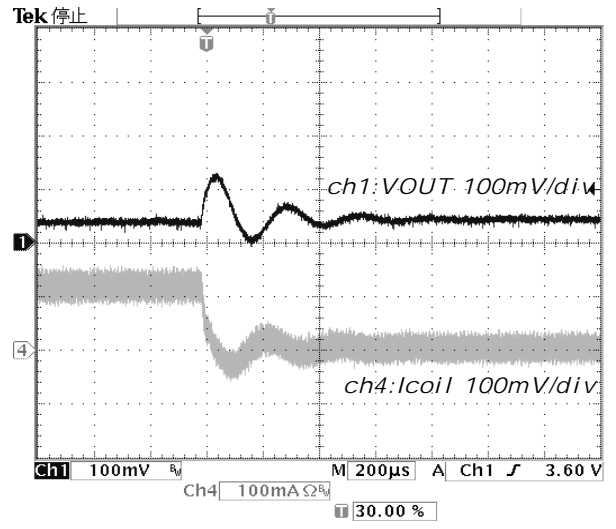

Figure 39. Io change PWM 100mA=>1mA
VIN=3.3V

●Electrical characteristic curves (Reference data) - Continued

• I_o change PFM

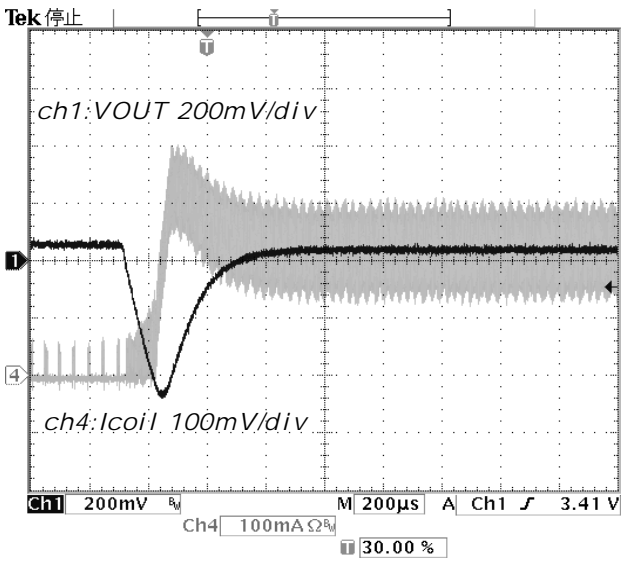

Figure 40. I_o change PFM 1mA=>100mA
VIN=1.8V

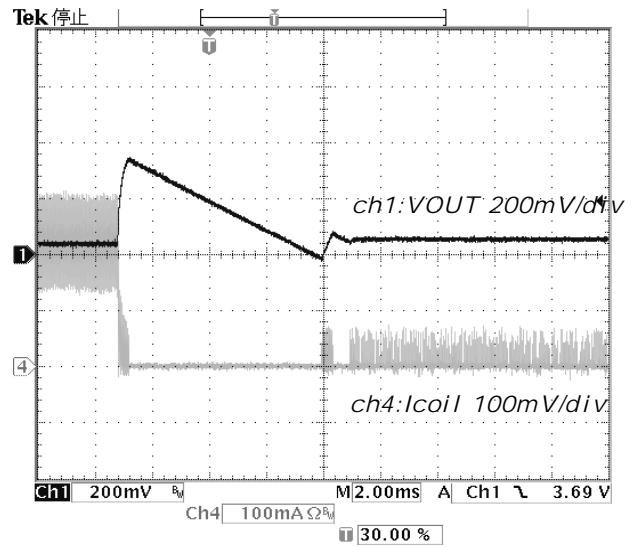

Figure 41. I_o change PFM 100mA=>1mA
VIN=1.8V

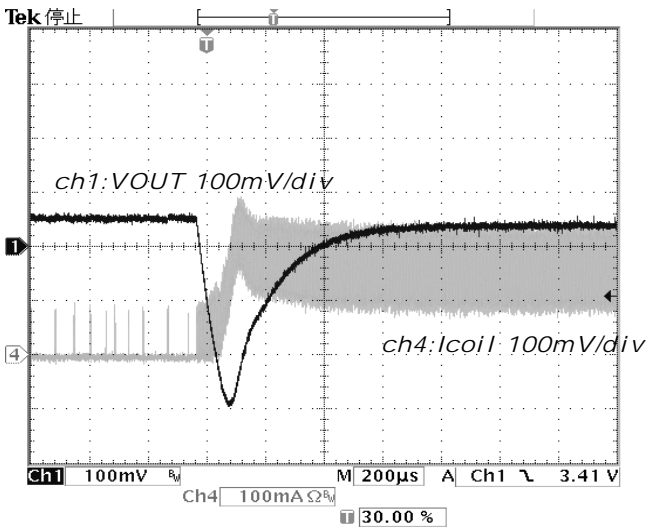

Figure 42. I_o change PFM 1mA=>100mA
VIN=2.4V

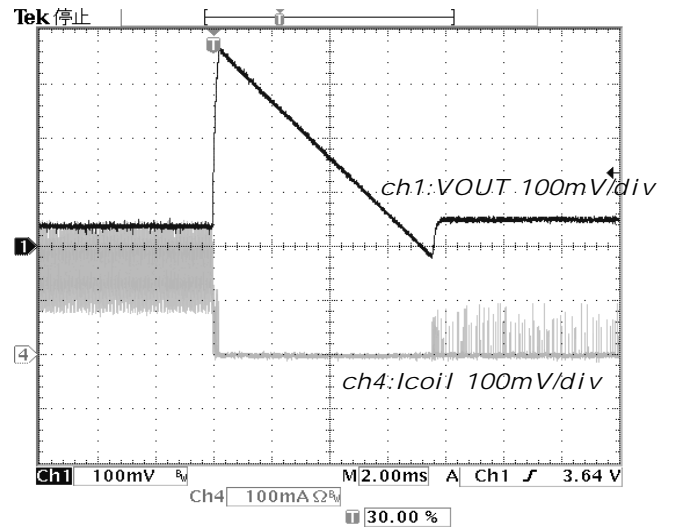

Figure 43. I_o change PFM 100mA=>1mA
VIN=2.4V

•Electrical characteristic curves (Reference data) – Continued

• Io change PFM - Continued

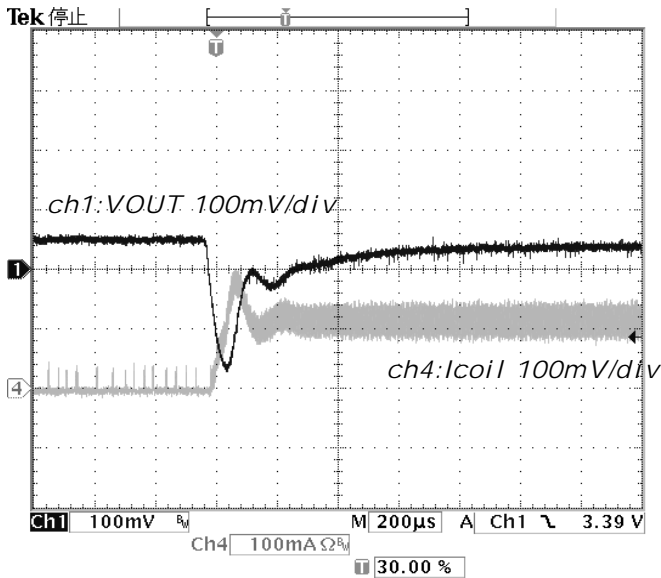

Figure 44. Io change PFM 1mA=>100mA
VIN=3.3V

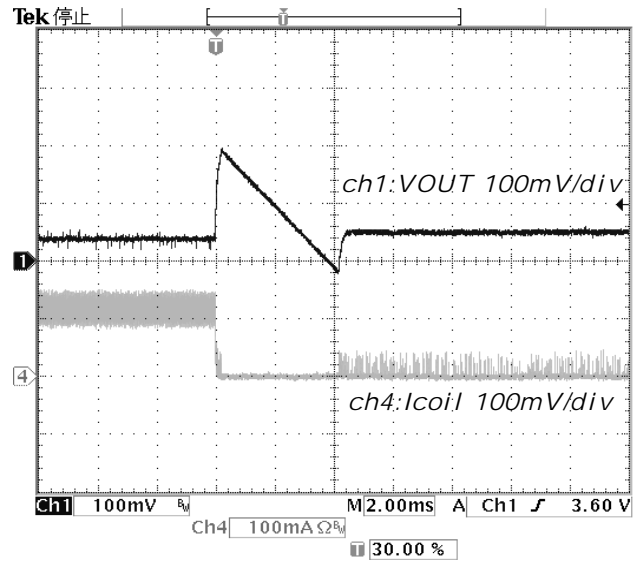

Figure 45. Io change PFM 100mA=>1mA
VIN=3.3V

•Notes

- Load Current 300mA (max)

Timing of possible Load 300mA (max) is dueling RSTBO "H".

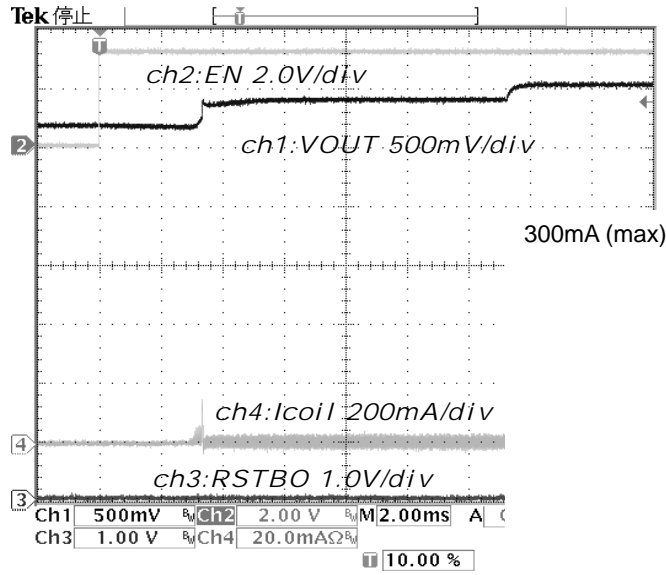

Figure 46. Load Current 300mA timing

-EN: ON<=>OFF PFM (MODE=VIN)

VIN connect to VOUT at Rswp2 MODE=VIN. Please note Drop of VOUT.

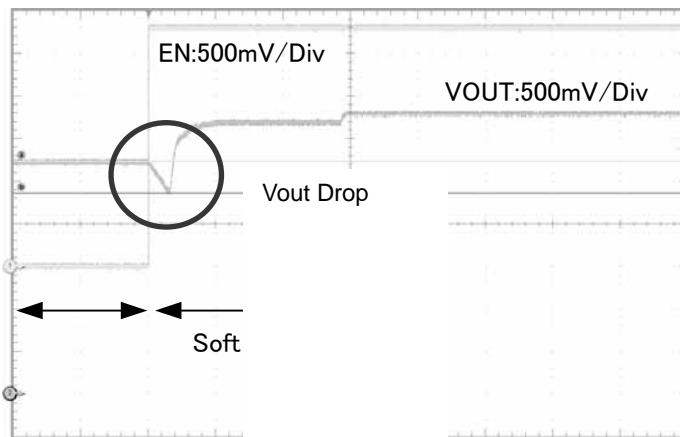
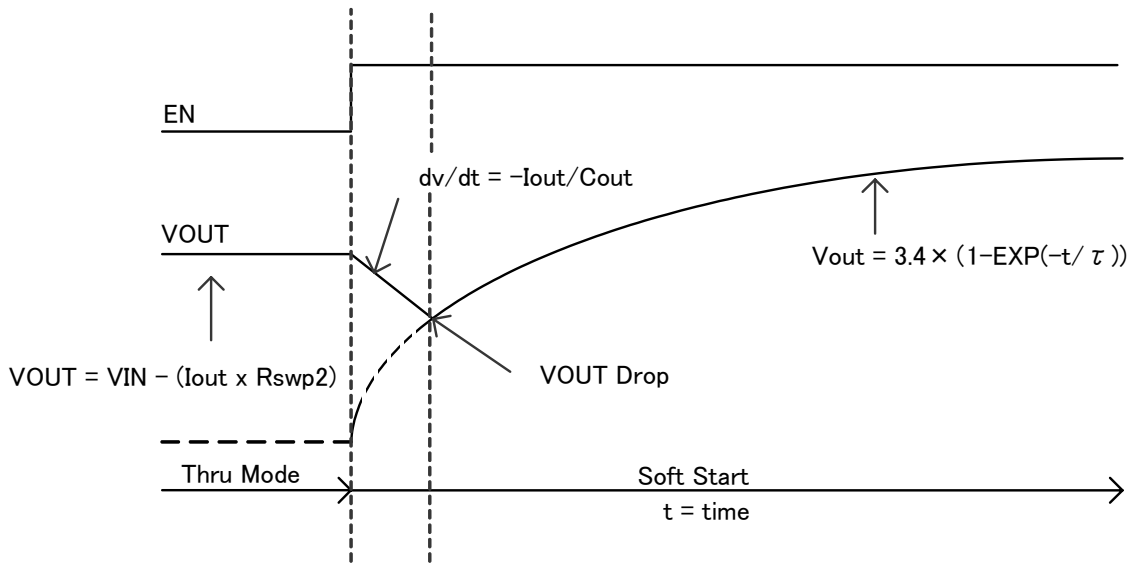
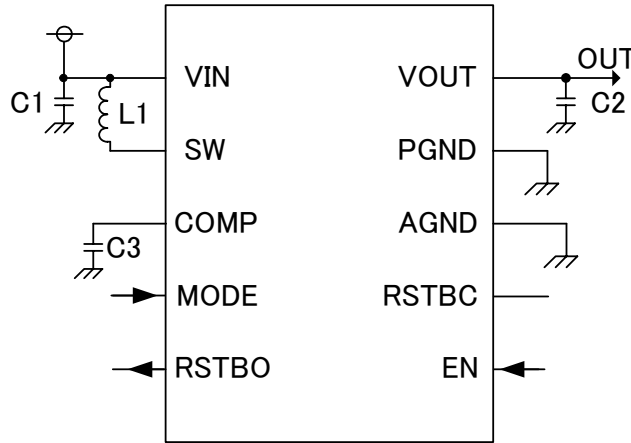

Figure 47. EN : L=>H PFM I_o=5mA
VIN=3.6V

•How to select parts of application

• PWM



Parts No.	Name	Value	STYLE(VENDOR)
L1	Inductance	6.8μH	VLF504015M-6R8M(TDK), LQH44PN6R8MP0L(Murata)
C1	Capacitor	10μF	X7R,X5R Ceramic
C2	Capacitor	22μF	X7R,X5R Ceramic
C3	Capacitor	470pF	X7R,X5R Ceramic

• PFM

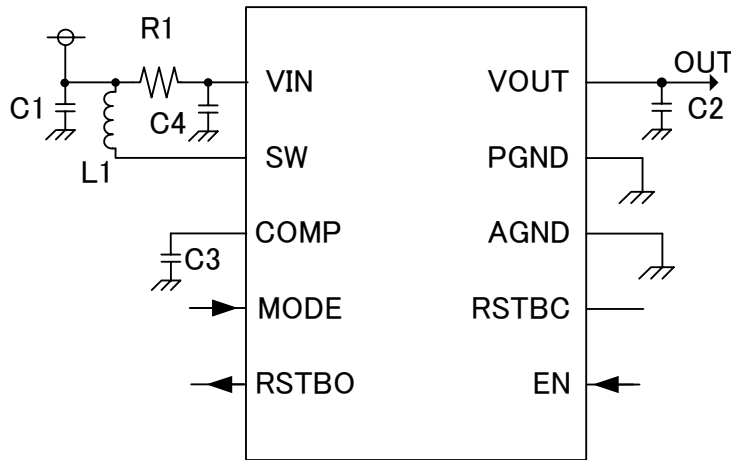

Parts No.	Name	Value	STYLE(VENDOR)
L1	Inductance	6.8uH	VLF504015M-6R8M(TDK), LQH44PN6R8MP0L(Murata)
C1	Capacitor	10μF	X7R,X5R Ceramic
C2	Capacitor	22μF	X7R,X5R Ceramic
C3	Capacitor	470pF	X7R,X5R Ceramic
C4	Capacitor	4.7μF	-
R1	Resister	10Ω	-

●Notes of board layout

BU34DV7NUX is switching DCDC converter, so characteristics of noise and etc changing by board layout. Please note the following respect besides a general board layout matter when you make PCB.

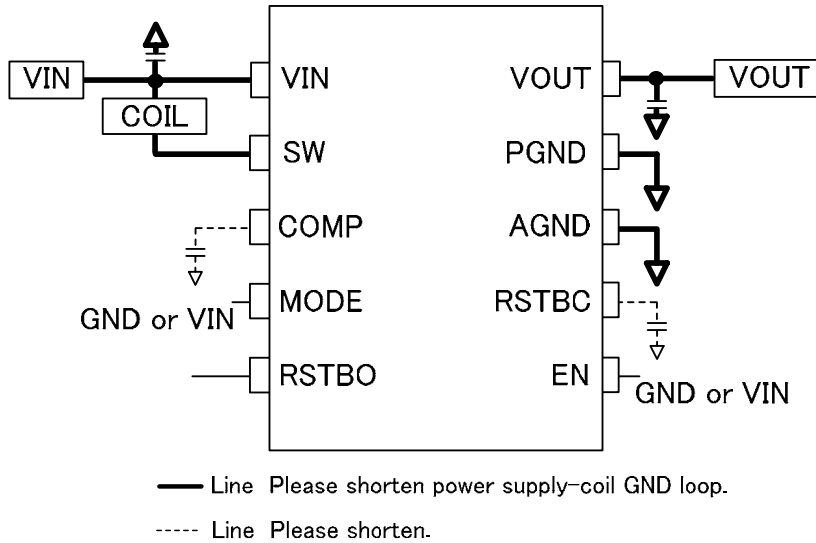

●About heat loss

In the heat design, please operate it in the following condition.
 (Please consider the margin etc. because the following temperature is a guarantee temperature.)

1. Surrounding temperature T_a must be 85°C or less.
2. Loss of IC must be permissible loss P_d or less.

The allowable dissipation (P_d) characteristics are described below.

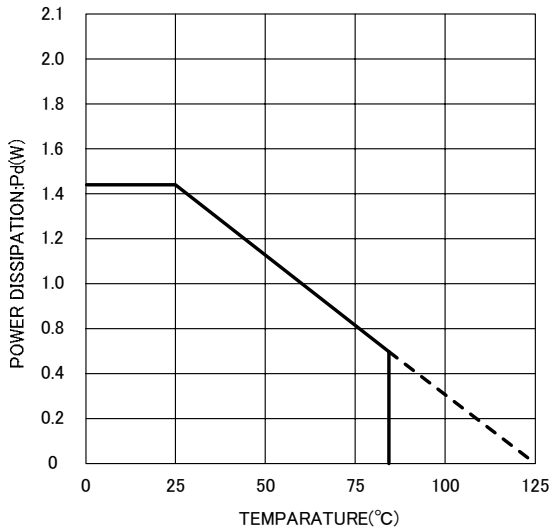

4layer(74.2 × 74.2mm) board
 (1,4layer heat radiation copper foil : 6.28mm²)
 (2,3layer heat radiation copper foil : 5500mm²)

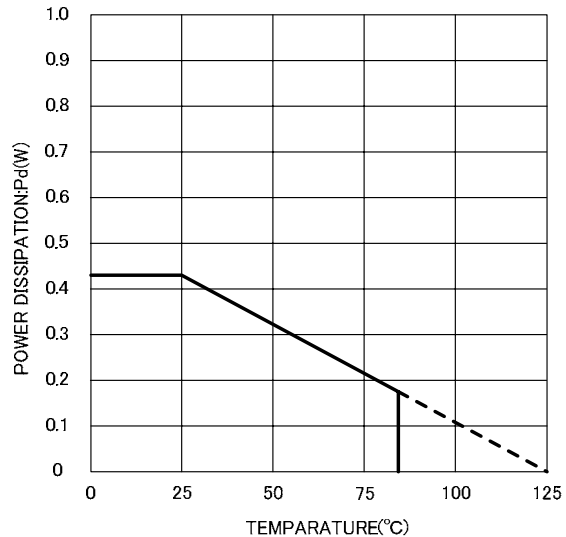

1layer(74.2 × 74.2mm) board
 (Surface heat radiation copper foil : 6.28mm²)

●Caution on use**(1) Absolute Maximum Ratings**

An excess in the absolute maximum rating, such as supply voltage, temperature range of operating conditions, etc., can break down devices, thus making impossible to identify breaking mode such as a short circuit or an open circuit. If any special mode exceeding the absolute maximum ratings is assumed, consideration should be given to take physical safety measures including the use of fuses, etc.

(2) The power supply and the GND lines

Design PCB pattern to provide low impedance for the wiring between the power supply and the GND lines. Please take care about interference by common impedance of the wiring pattern when there are two or more power supply and GND line. For the GND line, please note the separation of the large current route and the small signal route including the external circuit. Furthermore, for all power supply terminals to ICs; mount a capacitor between the power supply and the GND terminal. At the same time, in order to use an electrolytic capacitor, thoroughly check to be sure the characteristics of the capacitor to be used present no problem including the occurrence of capacity dropout at a low temperature, thus determining the constant.

(3) GND voltage

Make setting of the potential of the GND terminal so that it will be maintained at the minimum in any operating state.

(4) Short circuit between terminals and erroneous mounting

In order to mount ICs on a set PCB, pay thorough attention to the direction and offset of the ICs. Erroneous mounting can break down the ICs. Furthermore, if a short circuit occurs due to foreign matters entering between terminals or between the terminal and the power supply or the GND terminal, the ICs can break down.

(5) Operation in strong electromagnetic field

Be noted that using ICs in the strong electromagnetic field can malfunction them.

(6) Input terminals

In terms of the construction of IC, parasitic elements are inevitably formed in relation to potential. The operation of the parasitic element can cause interference with circuit operation, thus resulting in a malfunction and then breakdown of the input terminal. Therefore, pay thorough attention not to handle the input terminals, such as to apply to the input terminals a voltage lower than the GND respectively, so that any parasitic element will operate. Furthermore, do not apply a voltage to the input terminals when no power supply voltage is applied to the IC. In addition, even if the power supply voltage is applied, apply to the input terminals a voltage lower than the power supply voltage or within the guaranteed value of electrical characteristics.

(7) External capacitor

In order to use a ceramic capacitor as the external capacitor, determine the constant with consideration given to a degradation in the nominal capacitance due to DC bias and changes in the capacitance due to temperature, etc.

(8) Thermal design

Perform thermal design in which there are adequate margins by taking into account the permissible dissipation (Pd) in actual states of use. Moreover, please use it within the range where output Tr doesn't exceed the rated voltage and ASO.

- Caution on use- Continued

(9)Rush current

In CMOS IC, when the power supply is turned on rush current might flow momentarily in logical internal irregular state. Therefore, note drawing the capacity of the power supply coupling, the power supply, and width and drawing the GND pattern wiring, please.

(10)Test terminal and unused terminal processing

Please process a test terminal and unused terminal according to explanations of the function manual and the application note, etc. to be unquestionable while real used. Moreover, please inquire of the person in charge of our company about the terminal without the explanation especially.

(11)Content of material

The application notes etc. are the design material to design the application, and no one of the content securing it. Please decide the application after it examines enough and it evaluates it including external parts.

Status of this document

The Japanese version of this document is formal specification. A customer may use this translation version only for a reference to help reading the formal version.

If there are any differences in translation version of this document formal version takes priority

●Ordering part number

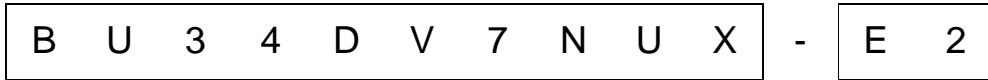

Part No.	Output Voltage	Package NUX: VSON010X3030	Wrapping, Forming specification E2:Reelemboss taping
----------	----------------	------------------------------	------------------------------------------------------------

VSON010X3030

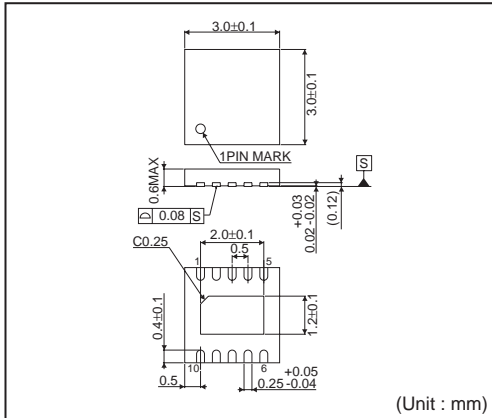

<Tape and Reel information>

Tape	Embossed carrier tape
Quantity	4000pcs
Direction of feed	E2 (The direction is the 1pin of product is at the upper left when you hold reel on the left hand and you pull out the tape on the right hand)

Reel

1pin

Direction of feed

*Order quantity needs to be multiple of the minimum quantity.

●Lineup

Output Voltage(Typ.)	Package	Orderable Part Number
3.4V	VSON010X3030	BU34DV7NUX-E2
3.3V	VSON010X3030	BU33DV7NUX-E2

●Marking Diagram(s) (TOP VIEW)

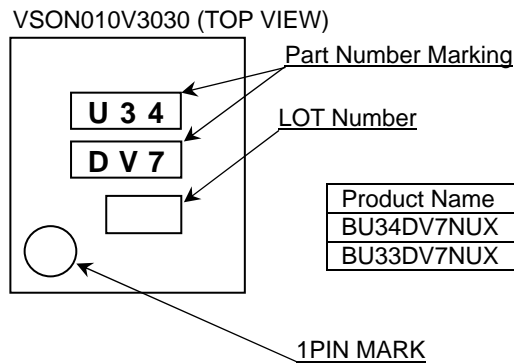
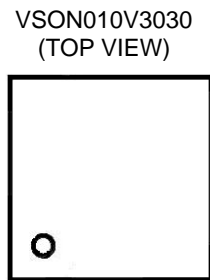

Product Name	Part Number Marking	
BU34DV7NUX	U34	DV7
BU33DV7NUX	U33	DV7

●Revision History

Date	Revision	Changes
2.Aug.2012	001	New Release

Notice

Precaution on using ROHM Products

- Our Products are designed and manufactured for application in ordinary electronic equipments (such as AV equipment, OA equipment, telecommunication equipment, home electronic appliances, amusement equipment, etc.). If you intend to use our Products in devices requiring extremely high reliability (such as medical equipment ^(Note 1), transport equipment, traffic equipment, aircraft/spacecraft, nuclear power controllers, fuel controllers, car equipment including car accessories, safety devices, etc.) and whose malfunction or failure may cause loss of human life, bodily injury or serious damage to property ("Specific Applications"), please consult with the ROHM sales representative in advance. Unless otherwise agreed in writing by ROHM in advance, ROHM shall not be in any way responsible or liable for any damages, expenses or losses incurred by you or third parties arising from the use of any ROHM's Products for Specific Applications.

(Note1) Medical Equipment Classification of the Specific Applications

JAPAN	USA	EU	CHINA
CLASS III	CLASS III	CLASS II b	CLASS III
CLASS IV		CLASS III	

- ROHM designs and manufactures its Products subject to strict quality control system. However, semiconductor products can fail or malfunction at a certain rate. Please be sure to implement, at your own responsibilities, adequate safety measures including but not limited to fail-safe design against the physical injury, damage to any property, which a failure or malfunction of our Products may cause. The following are examples of safety measures:
 - Installation of protection circuits or other protective devices to improve system safety
 - Installation of redundant circuits to reduce the impact of single or multiple circuit failure
- Our Products are designed and manufactured for use under standard conditions and not under any special or extraordinary environments or conditions, as exemplified below. Accordingly, ROHM shall not be in any way responsible or liable for any damages, expenses or losses arising from the use of any ROHM's Products under any special or extraordinary environments or conditions. If you intend to use our Products under any special or extraordinary environments or conditions (as exemplified below), your independent verification and confirmation of product performance, reliability, etc. prior to use, must be necessary:
 - Use of our Products in any types of liquid, including water, oils, chemicals, and organic solvents
 - Use of our Products outdoors or in places where the Products are exposed to direct sunlight or dust
 - Use of our Products in places where the Products are exposed to sea wind or corrosive gases, including Cl₂, H₂S, NH₃, SO₂, and NO₂
 - Use of our Products in places where the Products are exposed to static electricity or electromagnetic waves
 - Use of our Products in proximity to heat-producing components, plastic cords, or other flammable items
 - Sealing or coating our Products with resin or other coating materials
 - Use of our Products without cleaning residue of flux (even if you use no-clean type fluxes, cleaning residue of flux is recommended); or Washing our Products by using water or water-soluble cleaning agents for cleaning residue after soldering
 - Use of the Products in places subject to dew condensation
- The Products are not subject to radiation-proof design.
- Please verify and confirm characteristics of the final or mounted products in using the Products.
- In particular, if a transient load (a large amount of load applied in a short period of time, such as pulse. is applied, confirmation of performance characteristics after on-board mounting is strongly recommended. Avoid applying power exceeding normal rated power; exceeding the power rating under steady-state loading condition may negatively affect product performance and reliability.
- De-rate Power Dissipation (Pd) depending on Ambient temperature (Ta). When used in sealed area, confirm the actual ambient temperature.
- Confirm that operation temperature is within the specified range described in the product specification.
- ROHM shall not be in any way responsible or liable for failure induced under deviant condition from what is defined in this document.

Precaution for Mounting / Circuit board design

- When a highly active halogenous (chlorine, bromine, etc.) flux is used, the residue of flux may negatively affect product performance and reliability.
- In principle, the reflow soldering method must be used; if flow soldering method is preferred, please consult with the ROHM representative in advance.

For details, please refer to ROHM Mounting specification

Precautions Regarding Application Examples and External Circuits

1. If change is made to the constant of an external circuit, please allow a sufficient margin considering variations of the characteristics of the Products and external components, including transient characteristics, as well as static characteristics.
2. You agree that application notes, reference designs, and associated data and information contained in this document are presented only as guidance for Products use. Therefore, in case you use such information, you are solely responsible for it and you must exercise your own independent verification and judgment in the use of such information contained in this document. ROHM shall not be in any way responsible or liable for any damages, expenses or losses incurred by you or third parties arising from the use of such information.

Precaution for Electrostatic

This Product is electrostatic sensitive product, which may be damaged due to electrostatic discharge. Please take proper caution in your manufacturing process and storage so that voltage exceeding the Products maximum rating will not be applied to Products. Please take special care under dry condition (e.g. Grounding of human body / equipment / solder iron, isolation from charged objects, setting of Ionizer, friction prevention and temperature / humidity control).

Precaution for Storage / Transportation

1. Product performance and soldered connections may deteriorate if the Products are stored in the places where:
 - [a] the Products are exposed to sea winds or corrosive gases, including Cl₂, H₂S, NH₃, SO₂, and NO₂
 - [b] the temperature or humidity exceeds those recommended by ROHM
 - [c] the Products are exposed to direct sunshine or condensation
 - [d] the Products are exposed to high Electrostatic
2. Even under ROHM recommended storage condition, solderability of products out of recommended storage time period may be degraded. It is strongly recommended to confirm solderability before using Products of which storage time is exceeding the recommended storage time period.
3. Store / transport cartons in the correct direction, which is indicated on a carton with a symbol. Otherwise bent leads may occur due to excessive stress applied when dropping of a carton.
4. Use Products within the specified time after opening a humidity barrier bag. Baking is required before using Products of which storage time is exceeding the recommended storage time period.

Precaution for Product Label

QR code printed on ROHM Products label is for ROHM's internal use only.

Precaution for Disposition

When disposing Products please dispose them properly using an authorized industry waste company.

Precaution for Foreign Exchange and Foreign Trade act

Since our Products might fall under controlled goods prescribed by the applicable foreign exchange and foreign trade act, please consult with ROHM representative in case of export.

Precaution Regarding Intellectual Property Rights

1. All information and data including but not limited to application example contained in this document is for reference only. ROHM does not warrant that foregoing information or data will not infringe any intellectual property rights or any other rights of any third party regarding such information or data. ROHM shall not be in any way responsible or liable for infringement of any intellectual property rights or other damages arising from use of such information or data.:
2. No license, expressly or implied, is granted hereby under any intellectual property rights or other rights of ROHM or any third parties with respect to the information contained in this document.

Other Precaution

1. This document may not be reprinted or reproduced, in whole or in part, without prior written consent of ROHM.
2. The Products may not be disassembled, converted, modified, reproduced or otherwise changed without prior written consent of ROHM.
3. In no event shall you use in any way whatsoever the Products and the related technical information contained in the Products or this document for any military purposes, including but not limited to, the development of mass-destruction weapons.
4. The proper names of companies or products described in this document are trademarks or registered trademarks of ROHM, its affiliated companies or third parties.

General Precaution

1. Before you use our Products, you are requested to carefully read this document and fully understand its contents. ROHM shall not be in any way responsible or liable for failure, malfunction or accident arising from the use of any ROHM's Products against warning, caution or note contained in this document.
2. All information contained in this document is current as of the issuing date and subject to change without any prior notice. Before purchasing or using ROHM's Products, please confirm the latest information with a ROHM sales representative.
3. The information contained in this document is provided on an "as is" basis and ROHM does not warrant that all information contained in this document is accurate and/or error-free. ROHM shall not be in any way responsible or liable for any damages, expenses or losses incurred by you or third parties resulting from inaccuracy or errors of or concerning such information.

X-ON Electronics

Largest Supplier of Electrical and Electronic Components

Click to view similar products for [Switching Voltage Regulators](#) category:

Click to view products by [ROHM](#) manufacturer:

Other Similar products are found below :

[FAN53610AUC33X](#) [FAN53611AUC123X](#) [FAN48610BUC33X](#) [FAN48610BUC45X](#) [FAN48617UC50X](#) [R3](#) [430464BB](#) [KE177614](#)
[MAX809TTR](#) [NCV891234MW50R2G](#) [NCP81103MNTXG](#) [NCP81203PMNTXG](#) [NCP81208MNTXG](#) [NCP81109GMNTXG](#)
[SCY1751FCCT1G](#) [NCP81109JMNTXG](#) [AP3409ADNTR-G1](#) [NCP81241MNTXG](#) [LTM8064IY](#) [LT8315EFE#TRPBF](#) [LTM4664EY#PBF](#)
[LTM4668AIY#PBF](#) [NCV1077CSTBT3G](#) [XCL207A123CR-G](#) [MPM54304GMN-0002](#) [MPM54304GMN-0004](#) [MPM54304GMN-0003](#)
[XDPE132G5CG000XUMA1](#) [AP62300Z6-7](#) [MP8757GL-P](#) [MIC23356YFT-TR](#) [LD8116CGL](#) [HG2269M/TR](#) [OB2269](#) [XD3526](#) [U6215A](#)
[U6215B](#) [U6620S](#) [LTC3412IFE](#) [LT1425IS](#) [MAX25203BATJA/VY+](#) [MAX77874CEWM+](#) [XC9236D08CER-G](#) [ISL95338IRTZ](#) [MP3416GJ-P](#)
[BD9S201NUX-CE2](#) [MP5461GC-Z](#) [MPQ4415AGQB-Z](#) [MPQ4590GS-Z](#) [MAX38640BENT18+T](#)