

One Package Regulator Series

0.65A Output, Fully Integrated, Step-down Switching Power Supply Module



BZ6Axx06GM Series

●General Description

The BZ6Axx06GM is a fully integrated power supply module that is useful for shortening the product at the design period and shortening the product launch time for electronics product, communication of portable it, and various applications industrial etc.
BZ6Axx06GM is based on a high efficiency 6MHz synchronous step-down switching regulator. It provides up to 0.65A load current and an input voltage range from 2.3V to 5.5V, optimized for battery powered portable applications.
BZ6Axx06GM has a mode control pin that allows the user to select Forced PWM(Pulse Width Modulation) mode or PFM(Pulse Frequency Modulation) and PWM auto change mode utilized power save operation at light load current.

●Features

- No External components required SMPS
- Fast transient response
- Automatic PFM/PWM operation
- Forced PWM operation
- Internal Soft Start
- Under voltage lockout
- Over current protection
- Thermal shutdown
- Ultra small and low profile package

●Lineup

Part No.	Output voltage
BZ6A1206GM	1.20V
BZ6A7D06GM	1.25V

●Pin Configuration(s) (Top View)

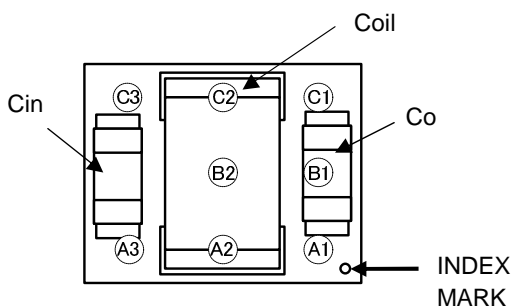

Figure 2. Pin Configuration(s)

●Applications

Smart Phones, Cell phones, Portable applications, POL applications, RF applications, and USB Line Application

●Package(s)
BGA-MD

W(Typ.) x D(Typ.) x H(Max.)
2.90mm x 2.30mm x 1.00mm



BGA-MD

●Typical Application Circuit(s)

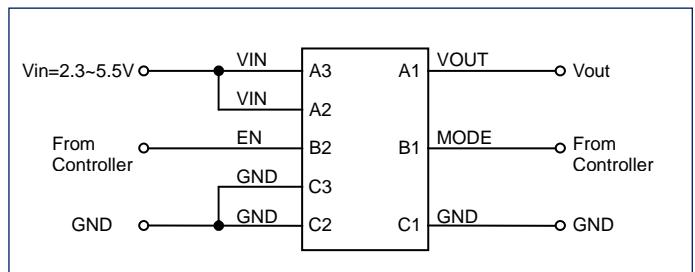
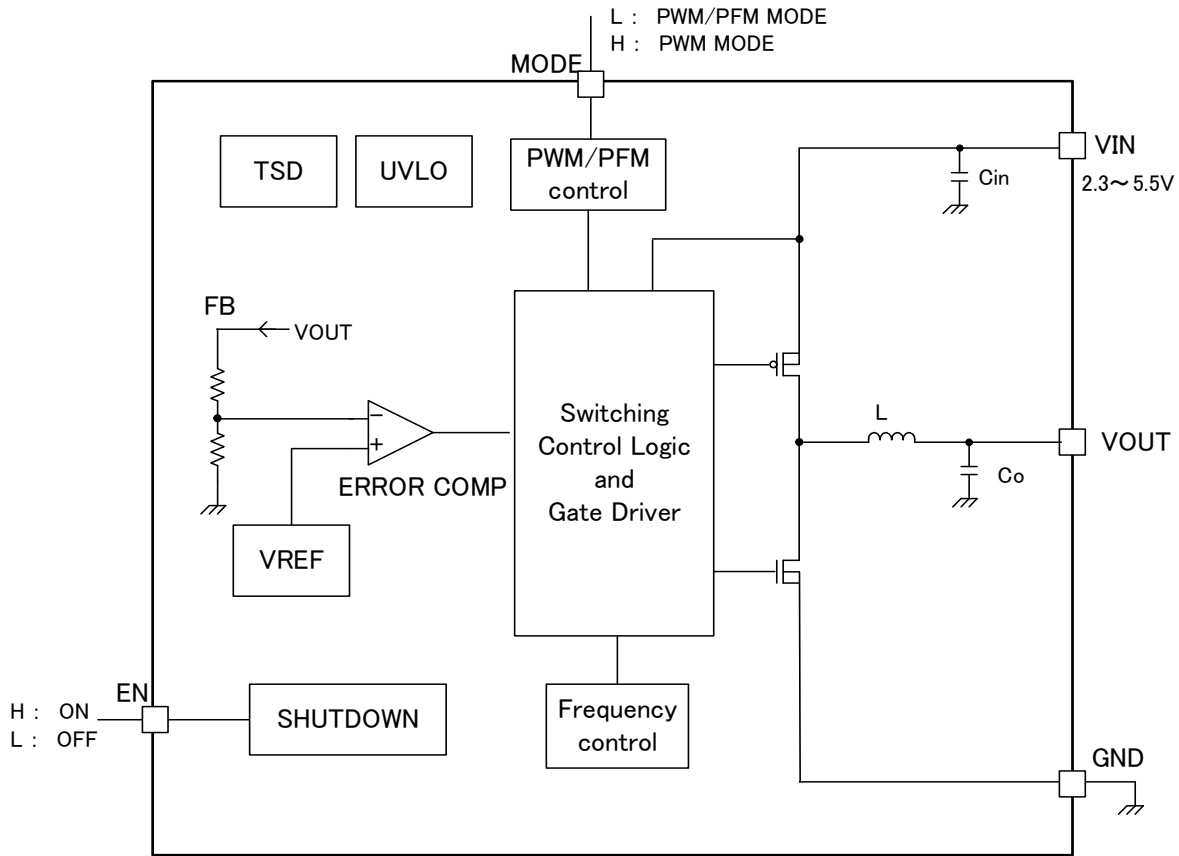

Figure 1. Typical Application Circuit(s)

●Pin Description(s)

Pin No.	Symbol	Name	Function
1	A1	VOUT	Output pin
2	A2	VIN	Power supply input pin
3	A3	VIN	Power supply input pin
4	B1	MODE	Forced PWM mode pin
5	B2	EN	Enable pin
6	C1	GND	GND pin
7	C2	GND	GND pin
8	C3	GND	GND pin

●Block Diagram(s)



Cin : C1005X5R0J225M
 Co : C1005X5R0J475M
 L : MLP2012V1R0M

Figure 3. Block Diagram(s)

●Description of Block(s)

The BZ6Axx06GM are a synchronous step-down DC/DC converter that achieves fast transient response from light load to heavy load by hysteretic PWM control system and current constant PFM control system.

○PWM control

BZ6Axx06GM operates by hysteretic PWM control. This scheme ensures fast switching, high efficiency, and fast transient response.

When the output voltage is below the VREF voltage, the error comparator output is low to high and turning on P-channel MOSFET until above the VREF voltage and minimum on time.

○PFM control

At light load the regulator and MODE=low, the regulator operates with reduced switching frequency and improves the efficiency.

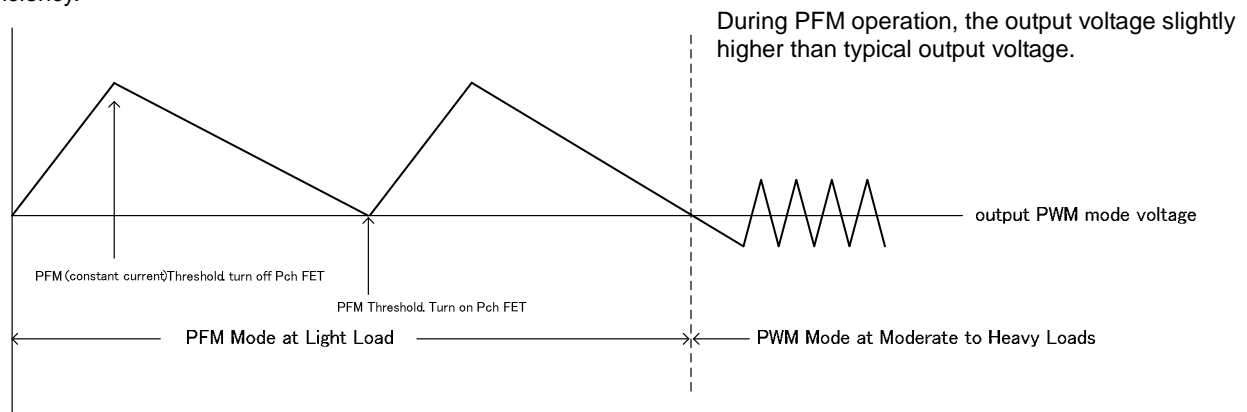

Figure 4. Operation of PFM mode and PWM mode

●Description of operations

- 1) Shutdown
If the EN input pin set to low (<0.4V), all circuit are shut down and the regulator is standby mode.
Do not leave the EN pin floating.
- 2) Soft start function
The regulator has a soft start circuit that reduces in-rush current at start-up. Typical start up times with a 4.7uF output capacitor is 120usec.
- 3) Current limit
The BZ6Axx06GM has a current limit circuit that protects itself and external components during overload condition.
- 4) Under Voltage Lock Out (UVLO)
The BZ6Axx06GM has a Under Voltage Lock Out circuit that turn off device when VIN>2.05V(typ.)
- 5) FORCED PWM MODE
Setting MODE pin high (>1.4V) places the regulator in forced PWM.This control provides noise reduction and output stability.
Do not leave the MODE pin floating.
- 6) TSD
The BZ6Axx06GM has a thermal shutdown feature to protect the device if the junction temperature exceeds 150°C.In thermal shutdown, the DRIVER is disabled.
This circuit is only to cut off the IC from thermal runaway, and has not been design to protect or guarantee the IC. Therefore, the user should not plan to activate this circuit with continued operation in mind.

●Absolute Maximum Ratings (Ta=25°C)

Parameter	Symbol	Rating	Unit
Maximum input power supply voltage	VIN	7	V
Power dissipation	Pd	0.75 *1	W
Operating temperature range	Topr	-40 to +85	°C
Storage temperature range	Tstg	-55 to +125	°C
Junction temperature	Tjmax	+125	°C

*1 When mounted on the specified PCB (55mm x 63mm), Deducted by 3.9m W/c when used over Ta=25c

●Recommended Operating Rating(s)

Parameter	Symbol	Rating			Unit
		Min.	Typ.	Max.	
Input voltage	VIN	2.3		5.5	V
Output current	IOUT	0		0.65	A

● **Electrical Characteristic(s)** (unless otherwise specified VIN=3.6V, Ta=25°C)

Item	Symbol	Rating			Unit	Condition	
		Min.	Typ.	Max.			
【Switching regulator】							
Output voltage accuracy	VOUTA	-2.5	-	+2.5	%	MODE:H(PWM Operation)	
		-2.5	-	+3.5		MODE:L(PFM Operation)	
【Soft start】							
Soft start time	Tss	65	120	240	usec		
【Control】							
EN pin control voltage	Operation	VENH	1.4	-	VIN	V	
	Non Operation	VENL	0	-	0.4	V	
MODE pin control voltage	Operation	VMODEH	1.4	-	VIN	V	Forced PWM
	Non Operation	VMODEL	0	-	0.4	V	Automatic PFM/PWM
【UVLO】							
Protect threshold voltage	Uvth	1.95	2.05	2.15	V		
Hysteresis	Uvhy	50	100	150	mV		
【Circuit current】							
Operating quiescent current	IINS	-	45	72	uA	EN:H, MODE:L, VOUT=3.6V forced Not switching	
Shutdown current	SHD	-	0	1	uA	EN=0V	

●Electrical characteristic curves (Reference data)
 BZ6A1206GM(1.20V OUTPUT)

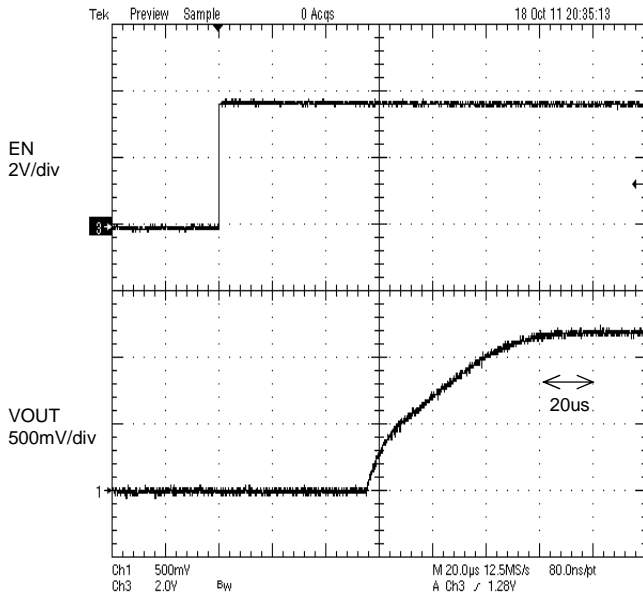

Figure 5. Start up

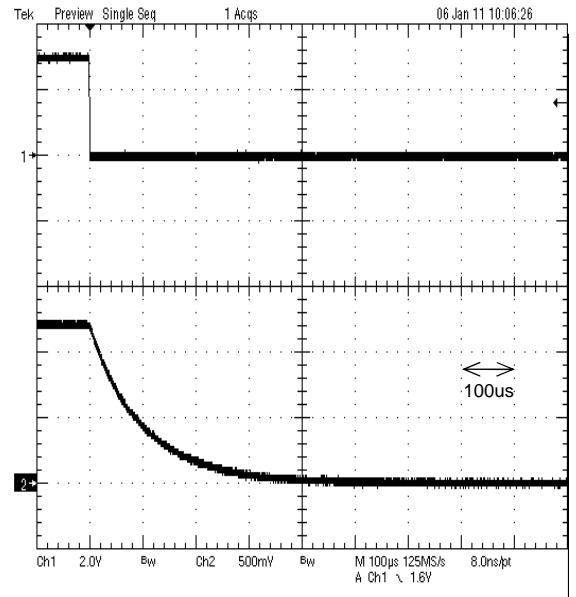

Figure 6. Shut down

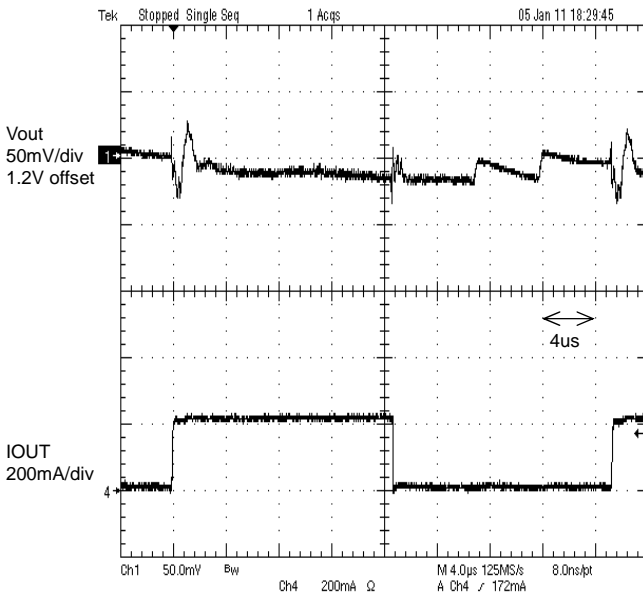

Figure 7. Load transient response 5mA to 200mA
 tr=tf=100ns, MODE : Low

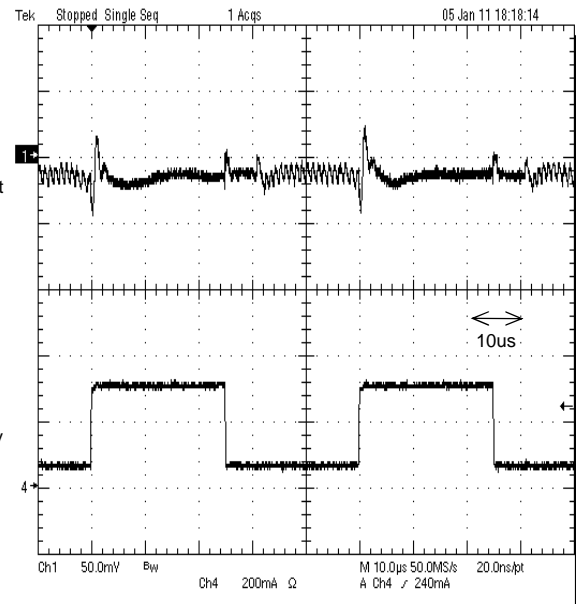

Figure 8. Load transient response 50mA to 350mA
 tr=tf=100ns, MODE : Low

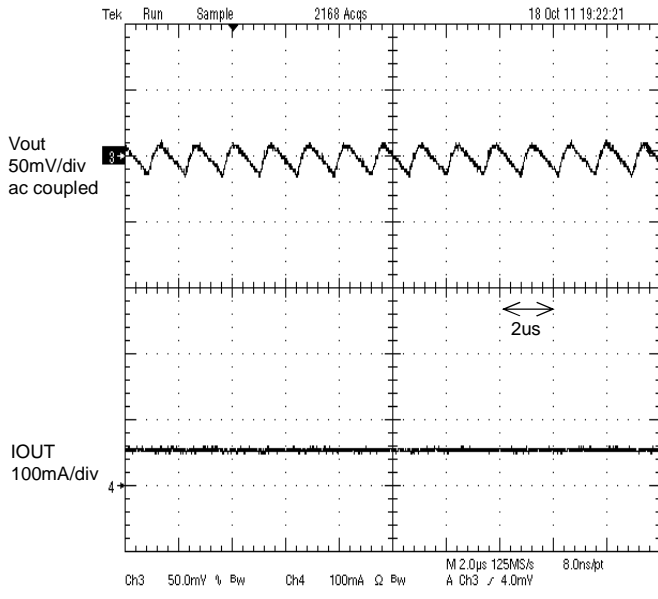

Figure 9. PWM/PFM Auto mode Operation
Iout=50mA

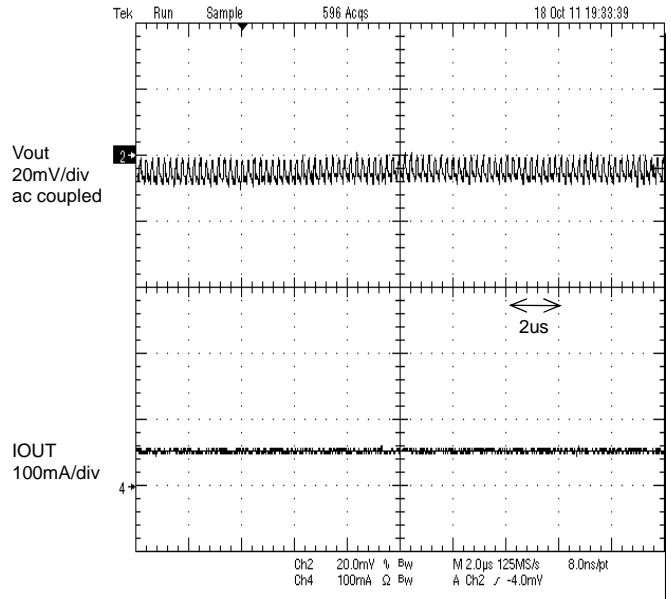

Figure 10. PWM mode Operation
Iout=50mA

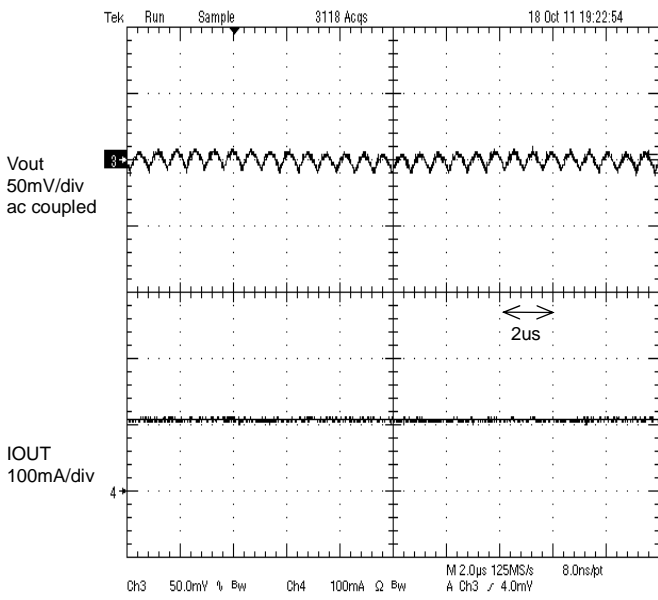

Figure 11. PWM/PFM Auto mode Operation
Iout=100mA

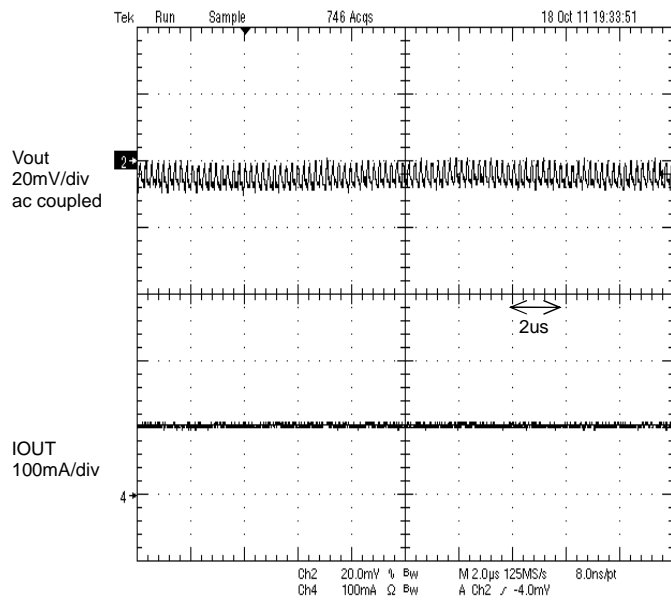

Figure 12. PWM mode Operation
Iout=100mA

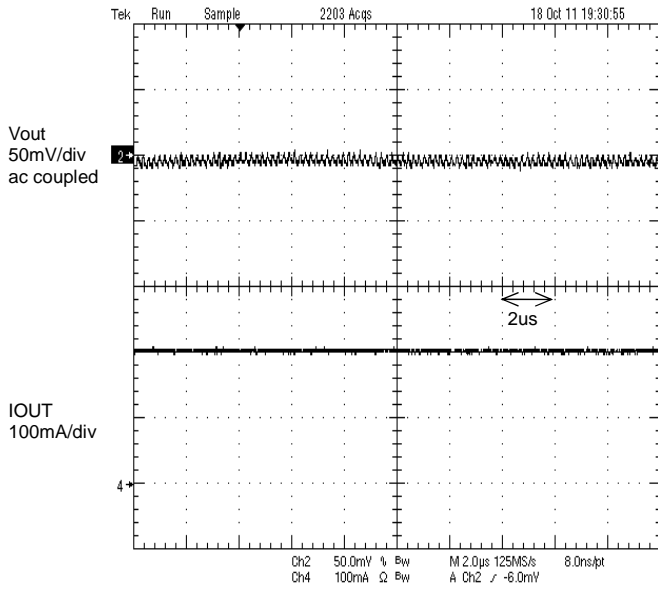

Figure 13. PWM/PFM Auto mode Operation
Iout=200mA

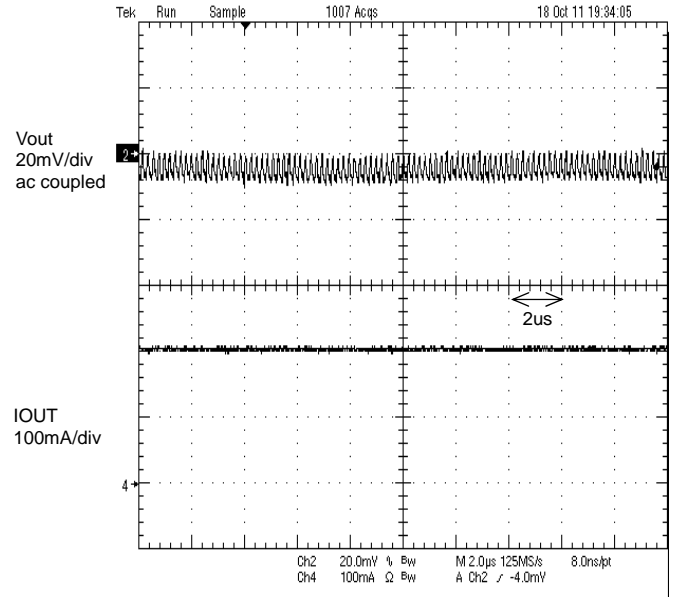

Figure 14. PWM mode Operation
Iout=200mA

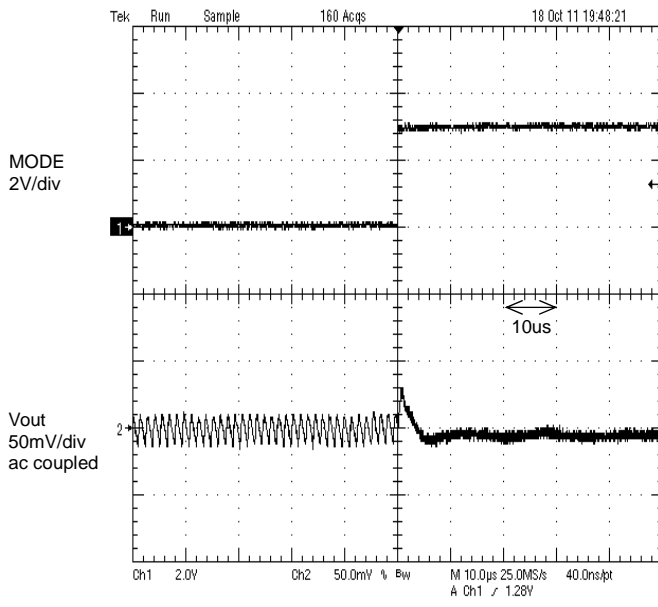

Figure 15. Mode Change Response
MODE : Low to High

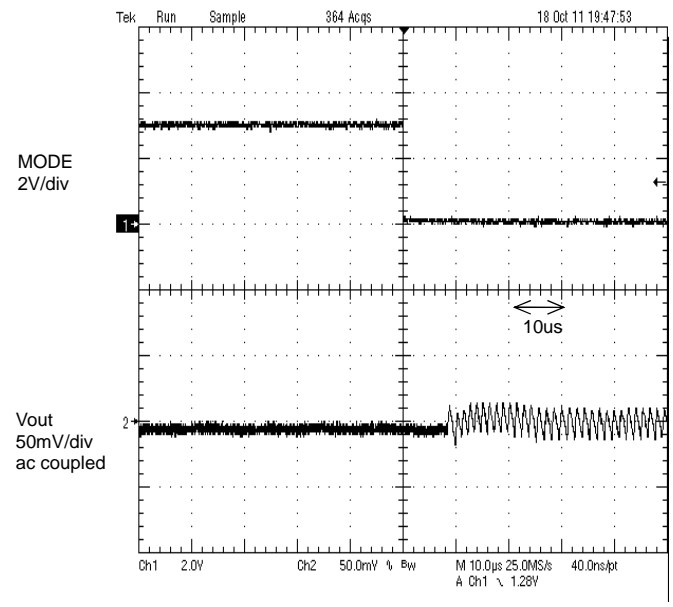

Figure 16. Mode Change Response
MODE : High to Low

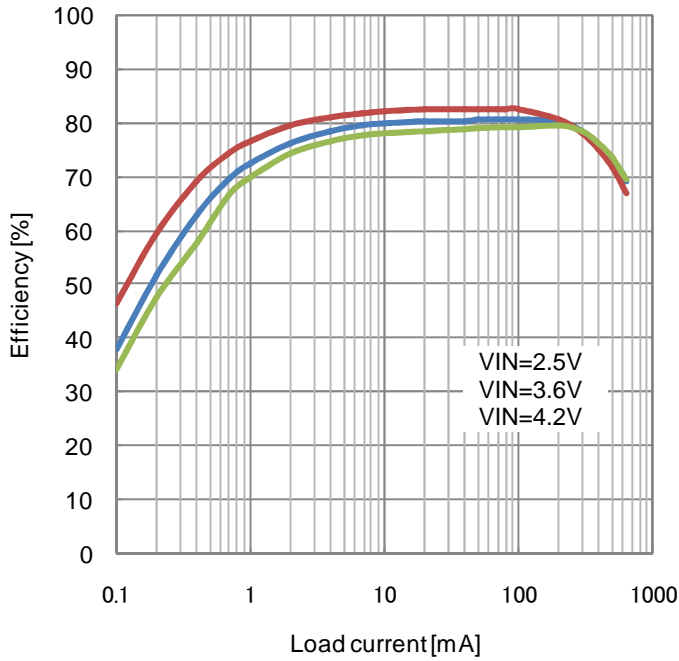

Figure 17. Efficiency vs Load current
PWM/PFM Auto mode

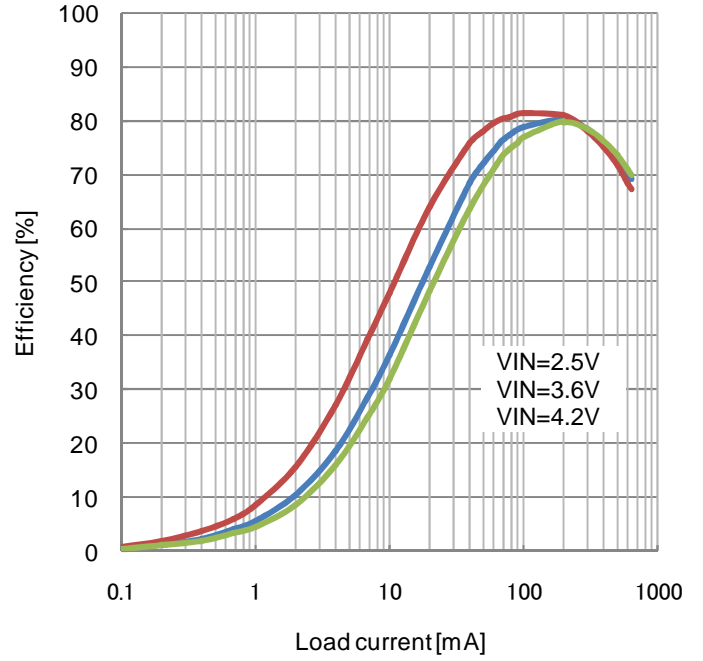

Figure 18. Efficiency vs Load current
PWM mode

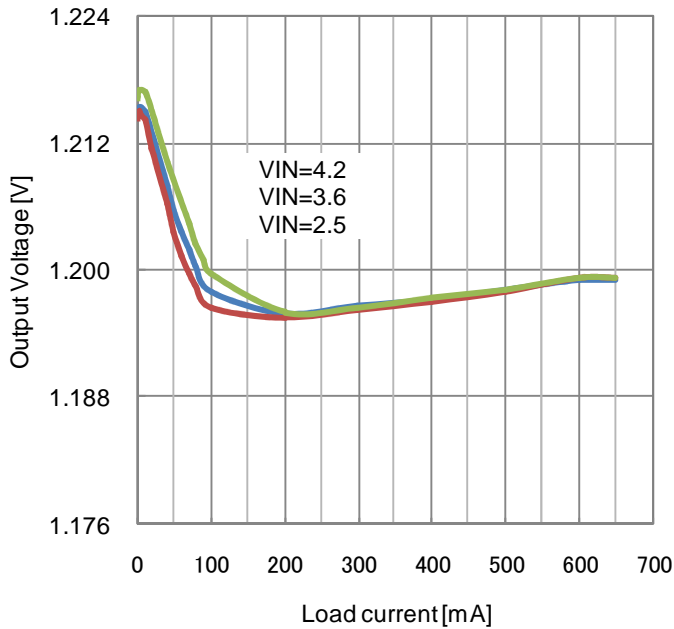

Figure 19. Load regulation
PWM/PFM Auto mode

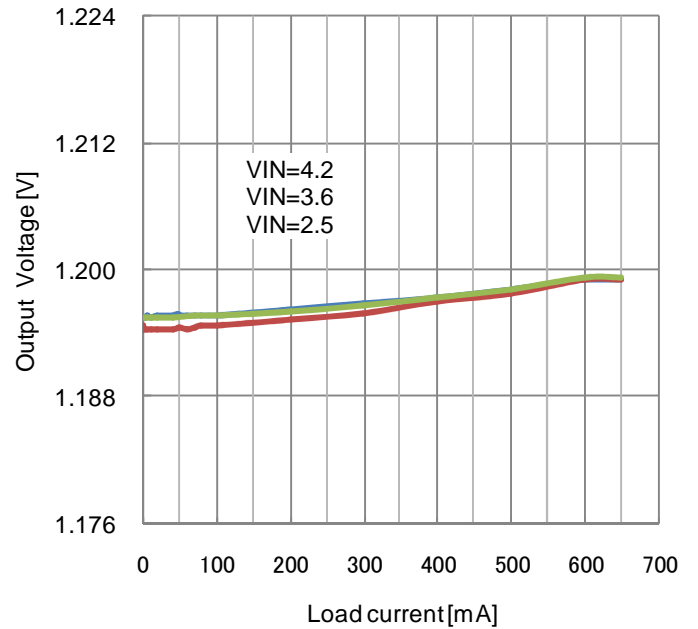

Figure 20. Load regulation
PWM mode

●Electrical characteristic curves (Reference data)
 BZ6A7D06GM(1.25V OUTPUT)

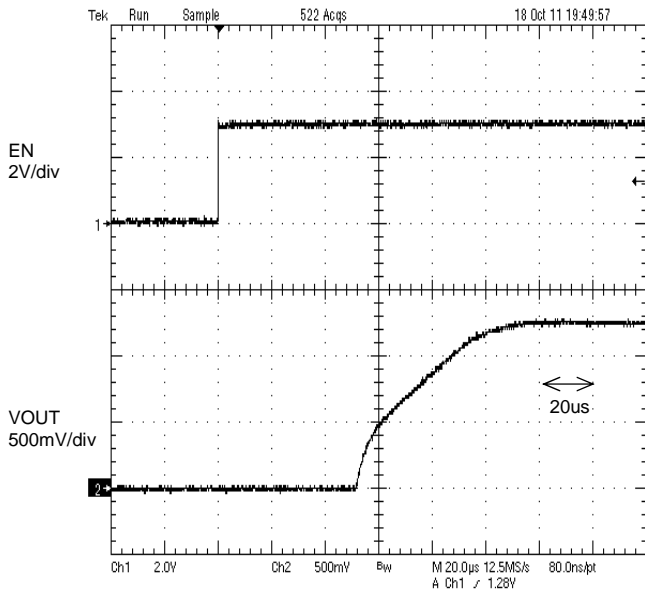

Figure 21. Start up

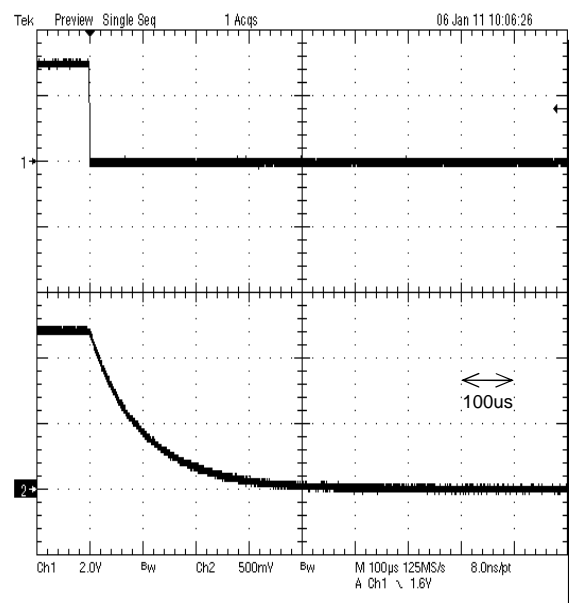

Figure 22. Shut down

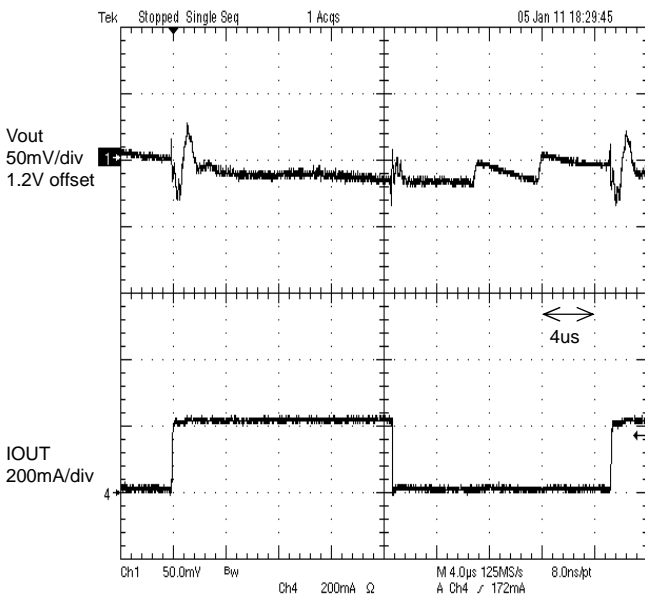

Figure 23. Load transient response 5mA to 200mA
 tr=tf=100ns, MODE : Low

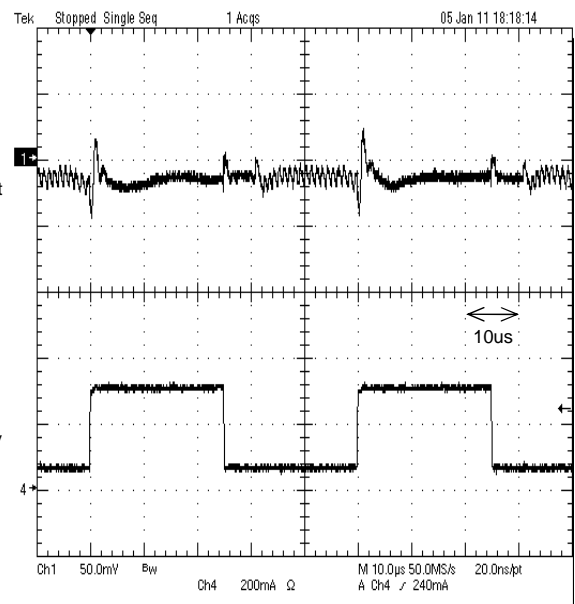

Figure 24. Load transient response 50mA to 350mA
 tr=tf=100ns, MODE : Low

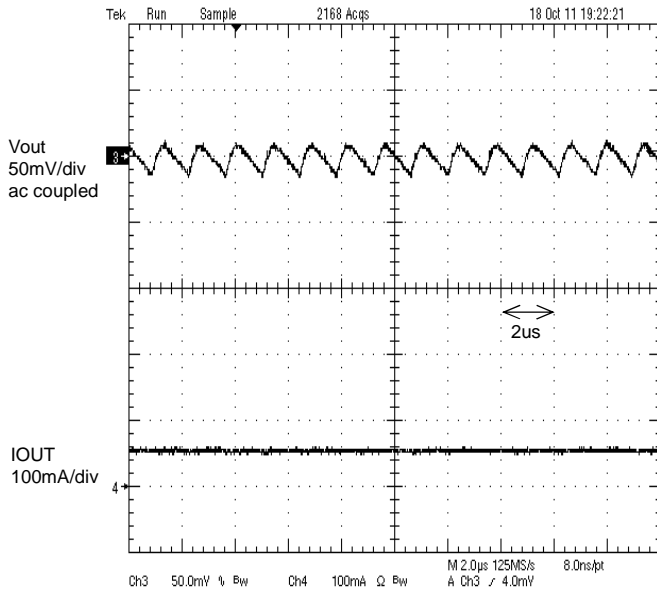

Figure 25. PWM/PFM Auto mode Operation
Iout=50mA

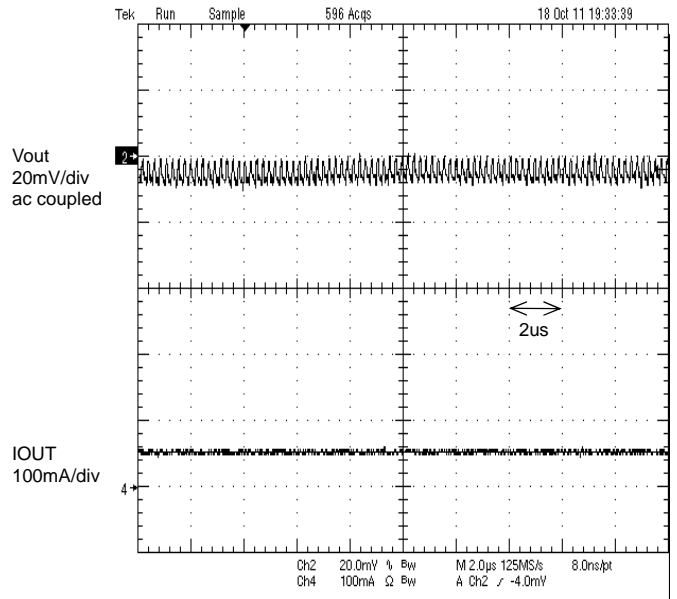

Figure 26. PWM mode Operation
Iout=50mA

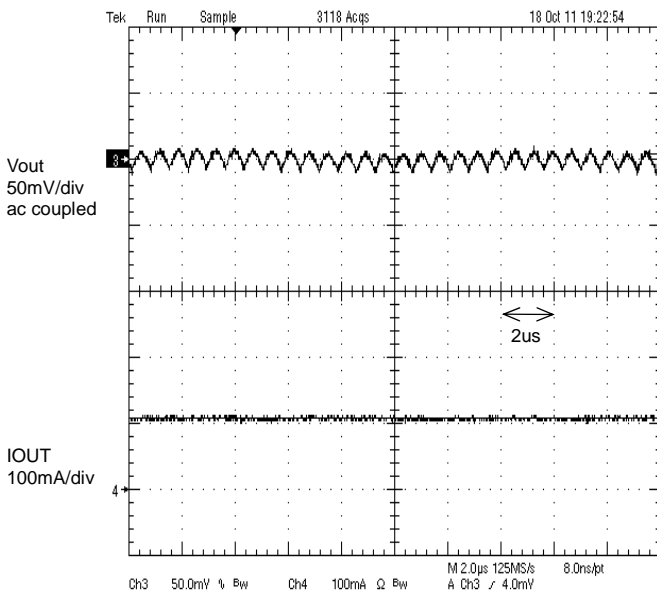

Figure 27. PWM/PFM Auto mode Operation
Iout=100mA

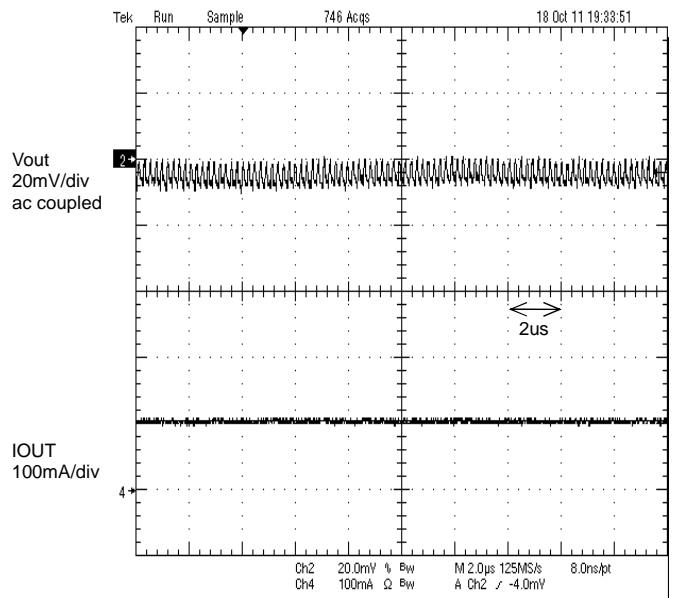

Figure 28. PWM mode Operation
Iout=100mA

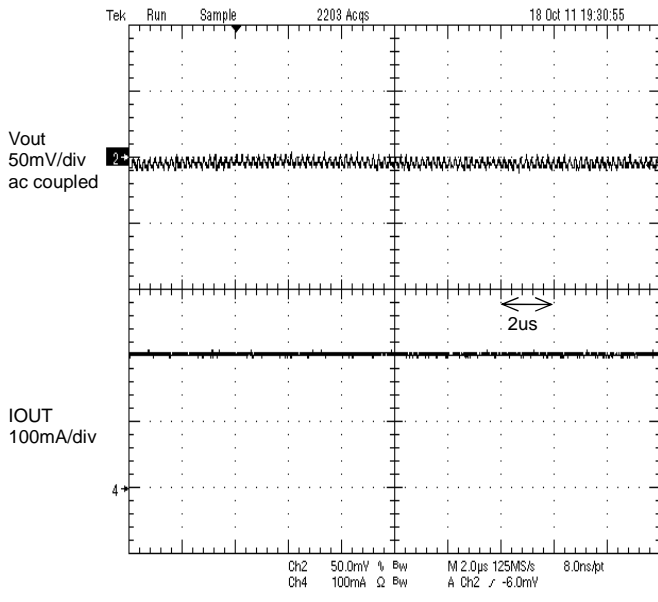

Figure 29. PWM/PFM Auto mode Operation
Iout=200mA

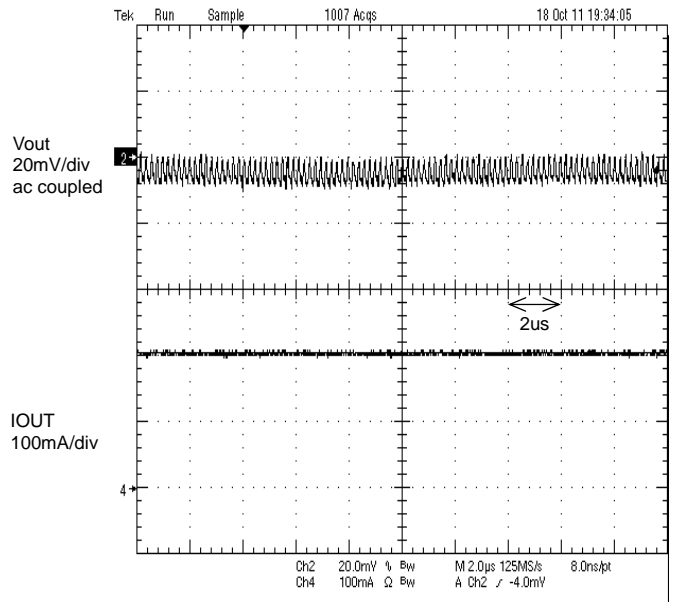

Figure 30. PWM mode Operation
Iout=200mA

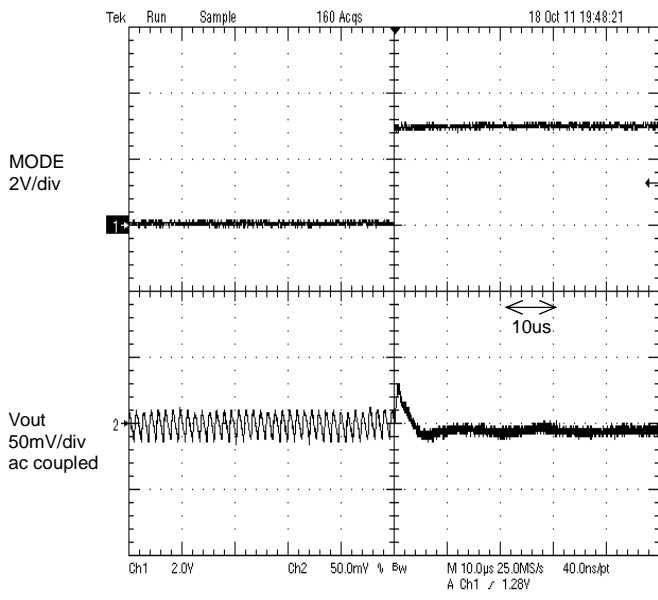

Figure 31. Mode Change Response
MODE : Low to High

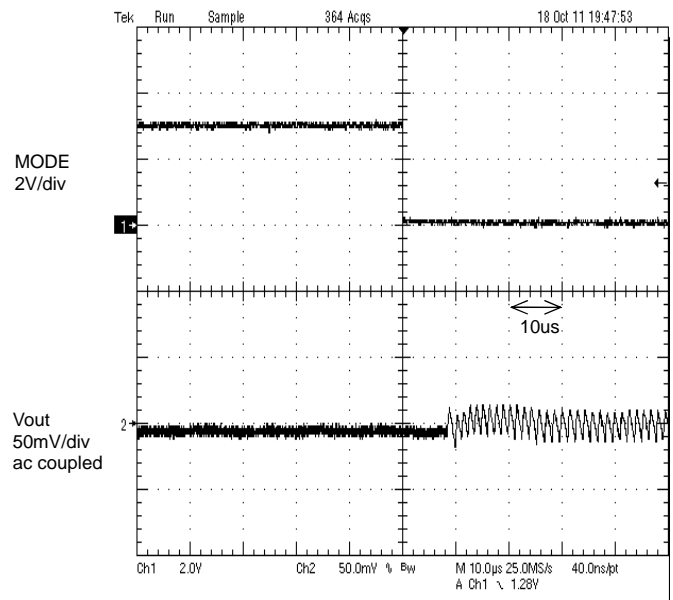

Figure 32. Mode Change Response
MODE : High to Low

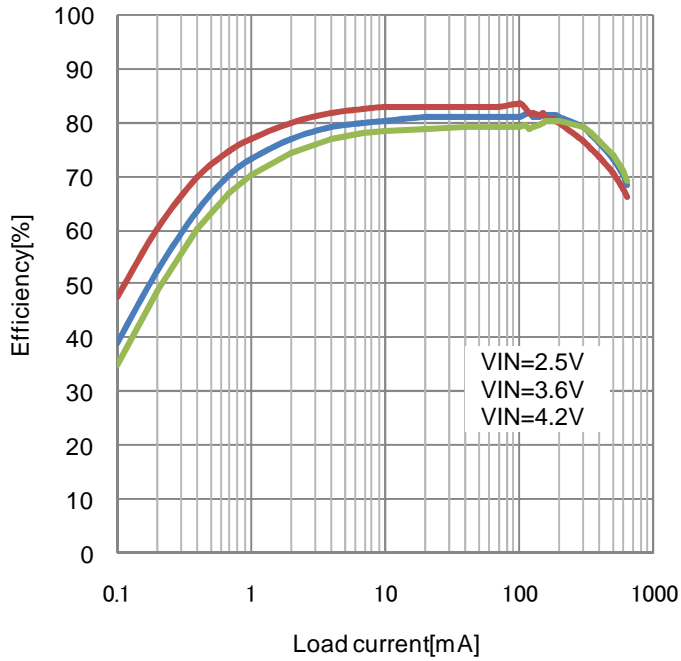

Figure 33. Efficiency vs Load current
PWM/PFM Auto mode

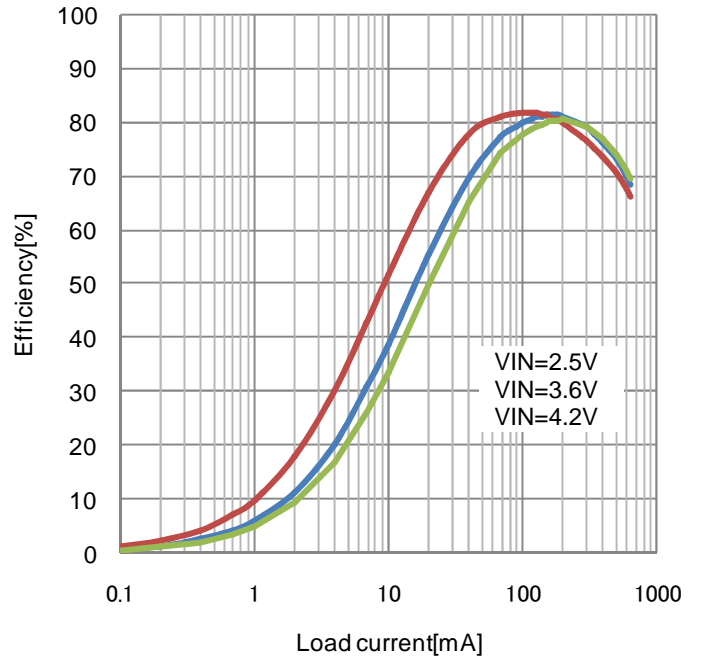

Figure 34. Efficiency vs Load current
PWM mode

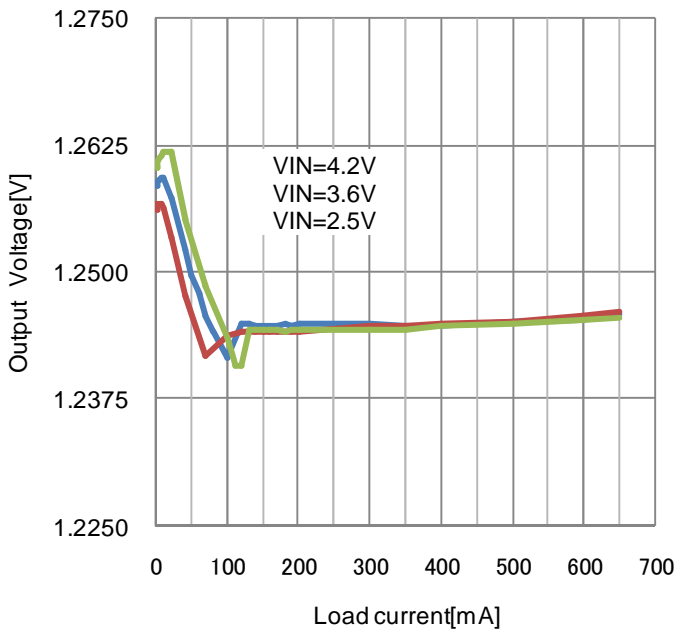

Figure 35. Load regulation
PWM/PFM Auto mode

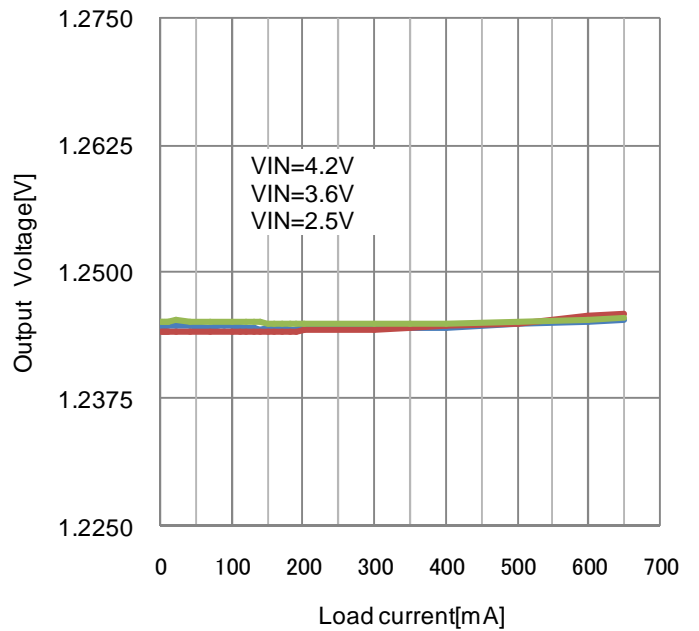

Figure 36. Load regulation
PWM mode

●PC Board layout

The suggested PCB layout for the BZ6Axx06GM is shown in Figure.

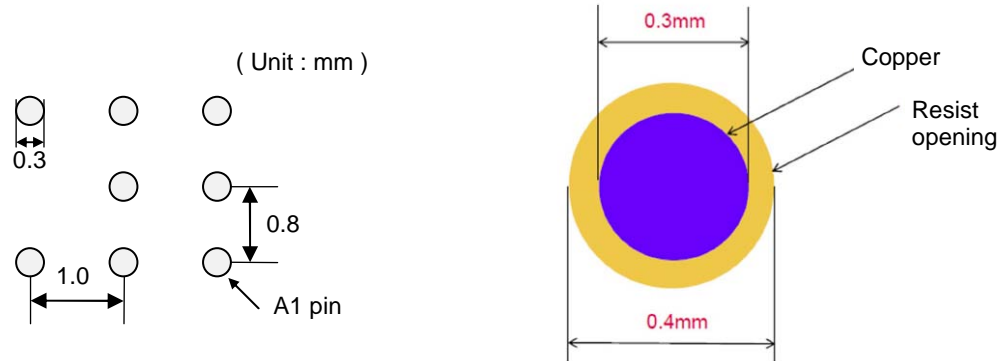

Figure 37. Recommended Land Pattern (TOP VIEW)

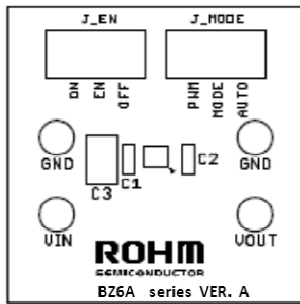

Figure 38. PCB layout (Mount side)

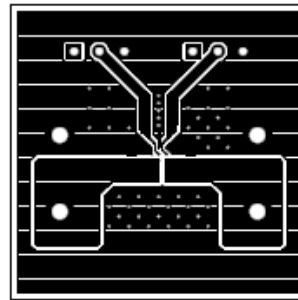

Figure 39. PCB layout (solder side)

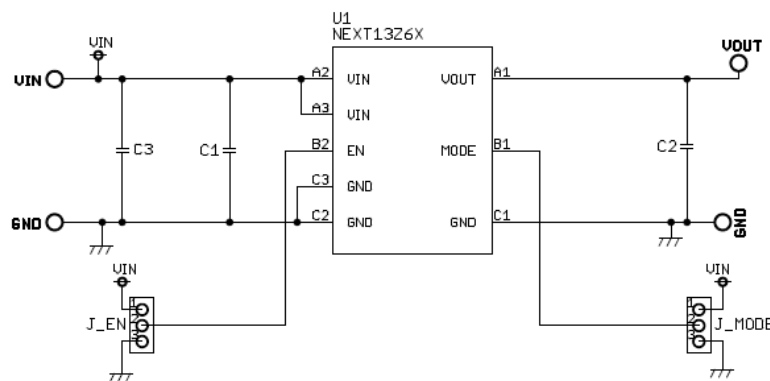

Figure 40. PCB Circuit

●Caution of use

1) Absolute maximum ratings

An excess in the absolute maximum rating, such as supply voltage, temperature range of operating conditions, etc., can break down the devices, thus making impossible to identify breaking mode, such as a short circuit or an open circuit. If any over rated values will expect to exceed the absolute maximum ratings, consider adding circuit protection devices, such as fuses.

2) GND voltage

The potential of GND pin must be minimum potential in all condition. As an exception, the circuit design allows voltages up to -0.3 V to be applied to the IC pin.

3) Thermal design

Use a thermal design that allows for a sufficient margin in light of the power dissipation (Pd) in actual operating conditions.

4) Inter-pin shorts and mounting errors

Use caution when positioning the IC for mounting on printed circuit boards. The IC may be damaged if there is any connection error or if pins are shorted together.

5) Actions in strong electromagnetic field

Use caution when using the IC in the presence of a strong electromagnetic field as doing so may cause the IC to malfunction.

6) Mutual impedance

Power supply and ground wiring should reflect consideration of the need to lower mutual impedance and minimize ripple as much as possible (by making wiring as short and thick as possible or rejecting ripple by incorporating inductance and capacitance).

7) Thermal shutdown Circuit (TSD Circuit)

This model IC has a built-in TSD circuit. This circuit is only to cut off the IC from thermal runaway, and has not been design to protect or guarantee the IC. Therefore, the user should not plan to activate this circuit with continued operation in mind.

8) Regarding input pin of the IC

This monolithic IC contains P+ isolation and P substrate layers between adjacent elements in order to keep them isolated.

P-N junctions are formed at the intersection of these P layers with the N layers of other elements, creating a parasitic diode or transistor. For example, as shown in the figures below, the relation between each potential is as follows:

When $GND > Pin A$ and $GND > Pin B$, the P-N junction operates as a parasitic diode.

When $GND > Pin B$, the P-N junction operates as a parasitic transistor.

Parasitic diodes can occur inevitable in the structure of the IC. The operation of parasitic diodes can result in mutual interference among circuits, operational faults, or physical damage. Accordingly, methods by which parasitic diodes operate, such as applying a voltage that is lower than the GND (P substrate) voltage to an input pin, should not be used.

Status of this document

The Japanese version of this document is formal specification. A customer may use this translation version only for a reference to help reading the formal version.

If there are any differences in translation version of this document formal version takes priority

●Ordering Information

B Z 6 A x x 0 6 G M					TR
Part Number	Frequency 6A : 6MHz	Output voltage 12 : 1.20V 7D : 1.25V	Output current 06 : 0.65A	Package GM: BGA-MD	Packaging and forming specification TR: Embossed tape and reel

●Physical Dimension Tape and Reel Information

BGA -MD

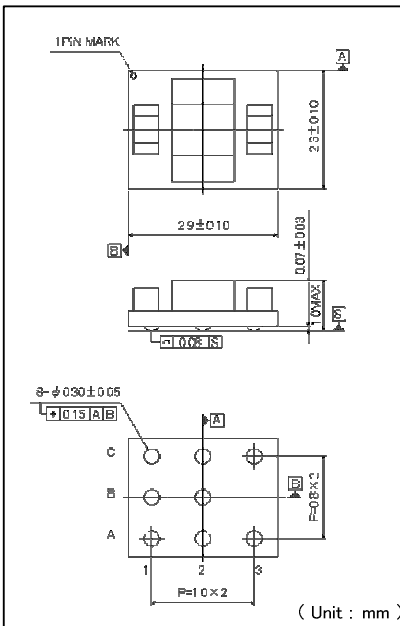

Tape	Embossed carrier tape
Quantity	9,000 pcs
Direction of feed	TR (The direction is the 1 pin of product is at the upper right when you hold reel on the left hand and you pull out the tape on the right hand.)

* Order quantity needs to be multiple of the minimum quantity.

●改訂履歴

Date	Revision	Changes
24.Jul.2012	001	New Release

Notice

Precaution on using ROHM Products

- Our Products are designed and manufactured for application in ordinary electronic equipments (such as AV equipment, OA equipment, telecommunication equipment, home electronic appliances, amusement equipment, etc.). If you intend to use our Products in devices requiring extremely high reliability (such as medical equipment ^(Note 1), transport equipment, traffic equipment, aircraft/spacecraft, nuclear power controllers, fuel controllers, car equipment including car accessories, safety devices, etc.) and whose malfunction or failure may cause loss of human life, bodily injury or serious damage to property ("Specific Applications"), please consult with the ROHM sales representative in advance. Unless otherwise agreed in writing by ROHM in advance, ROHM shall not be in any way responsible or liable for any damages, expenses or losses incurred by you or third parties arising from the use of any ROHM's Products for Specific Applications.

(Note1) Medical Equipment Classification of the Specific Applications

JAPAN	USA	EU	CHINA
CLASS III	CLASS III	CLASS II b	CLASS III
CLASS IV		CLASS III	

- ROHM designs and manufactures its Products subject to strict quality control system. However, semiconductor products can fail or malfunction at a certain rate. Please be sure to implement, at your own responsibilities, adequate safety measures including but not limited to fail-safe design against the physical injury, damage to any property, which a failure or malfunction of our Products may cause. The following are examples of safety measures:
 - Installation of protection circuits or other protective devices to improve system safety
 - Installation of redundant circuits to reduce the impact of single or multiple circuit failure
- Our Products are designed and manufactured for use under standard conditions and not under any special or extraordinary environments or conditions, as exemplified below. Accordingly, ROHM shall not be in any way responsible or liable for any damages, expenses or losses arising from the use of any ROHM's Products under any special or extraordinary environments or conditions. If you intend to use our Products under any special or extraordinary environments or conditions (as exemplified below), your independent verification and confirmation of product performance, reliability, etc. prior to use, must be necessary:
 - Use of our Products in any types of liquid, including water, oils, chemicals, and organic solvents
 - Use of our Products outdoors or in places where the Products are exposed to direct sunlight or dust
 - Use of our Products in places where the Products are exposed to sea wind or corrosive gases, including Cl₂, H₂S, NH₃, SO₂, and NO₂
 - Use of our Products in places where the Products are exposed to static electricity or electromagnetic waves
 - Use of our Products in proximity to heat-producing components, plastic cords, or other flammable items
 - Sealing or coating our Products with resin or other coating materials
 - Use of our Products without cleaning residue of flux (even if you use no-clean type fluxes, cleaning residue of flux is recommended); or Washing our Products by using water or water-soluble cleaning agents for cleaning residue after soldering
 - Use of the Products in places subject to dew condensation
- The Products are not subject to radiation-proof design.
- Please verify and confirm characteristics of the final or mounted products in using the Products.
- In particular, if a transient load (a large amount of load applied in a short period of time, such as pulse. is applied, confirmation of performance characteristics after on-board mounting is strongly recommended. Avoid applying power exceeding normal rated power; exceeding the power rating under steady-state loading condition may negatively affect product performance and reliability.
- De-rate Power Dissipation (Pd) depending on Ambient temperature (Ta). When used in sealed area, confirm the actual ambient temperature.
- Confirm that operation temperature is within the specified range described in the product specification.
- ROHM shall not be in any way responsible or liable for failure induced under deviant condition from what is defined in this document.

Precaution for Mounting / Circuit board design

- When a highly active halogenous (chlorine, bromine, etc.) flux is used, the residue of flux may negatively affect product performance and reliability.
- In principle, the reflow soldering method must be used; if flow soldering method is preferred, please consult with the ROHM representative in advance.

For details, please refer to ROHM Mounting specification

Precautions Regarding Application Examples and External Circuits

1. If change is made to the constant of an external circuit, please allow a sufficient margin considering variations of the characteristics of the Products and external components, including transient characteristics, as well as static characteristics.
2. You agree that application notes, reference designs, and associated data and information contained in this document are presented only as guidance for Products use. Therefore, in case you use such information, you are solely responsible for it and you must exercise your own independent verification and judgment in the use of such information contained in this document. ROHM shall not be in any way responsible or liable for any damages, expenses or losses incurred by you or third parties arising from the use of such information.

Precaution for Electrostatic

This Product is electrostatic sensitive product, which may be damaged due to electrostatic discharge. Please take proper caution in your manufacturing process and storage so that voltage exceeding the Products maximum rating will not be applied to Products. Please take special care under dry condition (e.g. Grounding of human body / equipment / solder iron, isolation from charged objects, setting of ionizer, friction prevention and temperature / humidity control).

Precaution for Storage / Transportation

1. Product performance and soldered connections may deteriorate if the Products are stored in the places where:
 - [a] the Products are exposed to sea winds or corrosive gases, including Cl₂, H₂S, NH₃, SO₂, and NO₂
 - [b] the temperature or humidity exceeds those recommended by ROHM
 - [c] the Products are exposed to direct sunshine or condensation
 - [d] the Products are exposed to high Electrostatic
2. Even under ROHM recommended storage condition, solderability of products out of recommended storage time period may be degraded. It is strongly recommended to confirm solderability before using Products of which storage time is exceeding the recommended storage time period.
3. Store / transport cartons in the correct direction, which is indicated on a carton with a symbol. Otherwise bent leads may occur due to excessive stress applied when dropping of a carton.
4. Use Products within the specified time after opening a humidity barrier bag. Baking is required before using Products of which storage time is exceeding the recommended storage time period.

Precaution for Product Label

QR code printed on ROHM Products label is for ROHM's internal use only.

Precaution for Disposition

When disposing Products please dispose them properly using an authorized industry waste company.

Precaution for Foreign Exchange and Foreign Trade act

Since our Products might fall under controlled goods prescribed by the applicable foreign exchange and foreign trade act, please consult with ROHM representative in case of export.

Precaution Regarding Intellectual Property Rights

1. All information and data including but not limited to application example contained in this document is for reference only. ROHM does not warrant that foregoing information or data will not infringe any intellectual property rights or any other rights of any third party regarding such information or data. ROHM shall not be in any way responsible or liable for infringement of any intellectual property rights or other damages arising from use of such information or data.:
2. No license, expressly or implied, is granted hereby under any intellectual property rights or other rights of ROHM or any third parties with respect to the information contained in this document.

Other Precaution

1. This document may not be reprinted or reproduced, in whole or in part, without prior written consent of ROHM.
2. The Products may not be disassembled, converted, modified, reproduced or otherwise changed without prior written consent of ROHM.
3. In no event shall you use in any way whatsoever the Products and the related technical information contained in the Products or this document for any military purposes, including but not limited to, the development of mass-destruction weapons.
4. The proper names of companies or products described in this document are trademarks or registered trademarks of ROHM, its affiliated companies or third parties.

General Precaution

1. Before you use our Products, you are requested to carefully read this document and fully understand its contents. ROHM shall not be in any way responsible or liable for failure, malfunction or accident arising from the use of any ROHM's Products against warning, caution or note contained in this document.
2. All information contained in this document is current as of the issuing date and subject to change without any prior notice. Before purchasing or using ROHM's Products, please confirm the latest information with a ROHM sales representative.
3. The information contained in this document is provided on an "as is" basis and ROHM does not warrant that all information contained in this document is accurate and/or error-free. ROHM shall not be in any way responsible or liable for any damages, expenses or losses incurred by you or third parties resulting from inaccuracy or errors of or concerning such information.

X-ON Electronics

Largest Supplier of Electrical and Electronic Components

Click to view similar products for [ROHM](#) manufacturer:

Other Similar products are found below :

[BP5034D24](#) [BP5013](#) [BP5011](#) [BP5718A12](#) [RPI-441C1](#) [RN142ZST2R](#) [SML-012VTT86A](#) [RB055LA-40TR](#) [RB886YT2R](#) [RB851YT2R](#)
[1SS400GT2R](#) [MCR100JZHF30R1](#) [MCR100JZHJ150](#) [MCR50JZHFLR820](#) [MCR50JZHJ330](#) [ML610Q793-SDK](#) [MNR34J5ABJ223](#)
[BD750L2FP-EVK-301](#) [BD9009HFP-EVK-001](#) [BD9285F-GE2](#) [SCT2H12NZGC11](#) [RB168L-60TE25](#) [MCR100JZHF1301](#) [MCR100JZHJ4R3](#)
[MCR100JZHJ513](#) [MCR100JZHJ683](#) [BD9B300MUV-EVK-001](#) [MNR12ERAPJ100](#) [MNR34J5ABJ221](#) [BD9060HFP-EVK-001](#)
[BD9611MUV-EVK-001](#) [BD9C601EFJ-EVK-001](#) [BD9D321EFJ-EVK-101](#) [BD9G341AEFJ-EVK-101](#) [BA7603F-E2](#) [BD95820N-LB](#)
[BD9A100MUV-EVK-001](#) [BD9C501EFJ-EVK-001](#) [BU90005GWZ-E2-EVK-101](#) [BH1715FVC-TR](#) [LA-401XD](#) [RSX301L-30TE25](#)
[BH1790GLC-EVK-001](#) [BU33UV7NUX-EVK-101](#) [BD9B301MUV-EVK-101](#) [BA7071F-E2](#) [SK-AD01-D62Q1367TB](#) [BM2P129TF-EVK-001](#)
[RB-D62Q1577TB100](#) [RB-D62Q1552GA64](#)