



## ± 2g / 4g / 8g / 16g Tri-axis Digital Accelerometer Specifications

PART NUMBER:

KXTJ3-1058  
Rev. 0.4  
July-2016

### Product Description

The KXTJ3 is a tri-axis +/-2g, +/-4g, +/-8g or +/-16g silicon micromachined accelerometer. The sense element is fabricated using Kionix's proprietary plasma micromachining process technology. Acceleration sensing is based on the principle of a differential capacitance arising from acceleration-induced motion of the sense element, which further utilizes common mode cancellation to decrease errors from process variation, temperature, and environmental stress. The sense element is hermetically sealed at the wafer level by bonding a second silicon lid wafer to the device using a glass frit. A separate ASIC device packaged with the sense element provides signal conditioning and digital communications. The accelerometer is delivered in a 2 x 2 x 0.9 mm LGA plastic package operating from a 1.8 – 3.6V DC supply. Voltage regulators are used to maintain constant internal operating voltages over the range of input supply voltages. This results in stable operating characteristics over the range of input supply voltages and virtually undetectable ratiometric error. The I<sup>2</sup>C digital protocol is used to communicate with the chip to configure the part and monitor outputs.

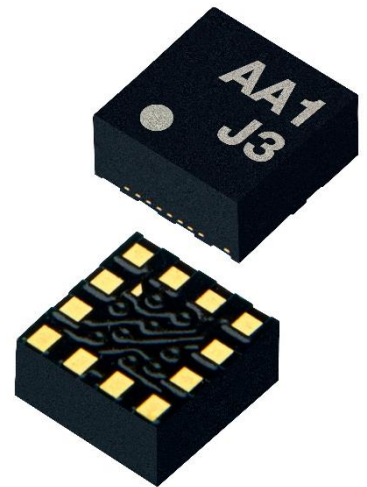





# ± 2g / 4g / 8g / 16g Tri-axis Digital Accelerometer Specifications

PART NUMBER:

KXTJ3-1058  
Rev. 0.4  
July-2016

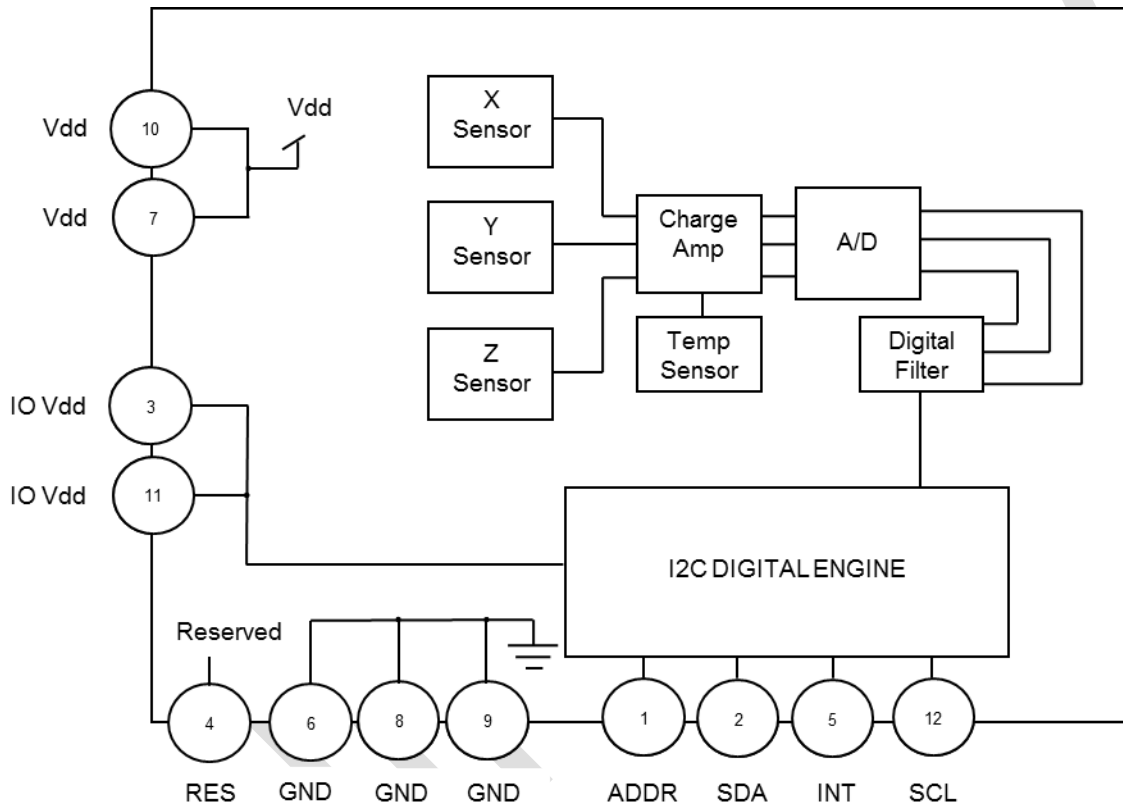
## Functional Diagram



	<b>± 2g / 4g / 8g / 16g Tri-axis Digital Accelerometer Specifications</b>	<b>PART NUMBER:</b>  <b>KXTJ3-1058</b> <b>Rev. 0.4</b> <b>July-2016</b>
---	---	---

## Product Specifications

**Table 1. Mechanical**

(specifications are for operation at 2.6V and T = 25C unless stated otherwise)

Parameters		Units	Min	Typical	Max
Operating Temperature Range		°C	-40	-	85
Zero-g Offset				±25	±100
Zero-g Offset Variation from RT over Temp.		mg/°C		0.2	
Sensitivity (14-bit) <sup>1,2</sup>	GSEL1=1, GSEL0=1, EN16G=0 (± 8g)	counts/g	973	1024	1075
	GSEL1=1, GSEL0=1, EN16G=1 (± 16g)		461	512	563
Sensitivity (12-bit) <sup>1</sup>	GSEL1=0, GSEL0=0, EN16G=0 (± 2g)	counts/g	973	1024	1075
	GSEL1=0, GSEL0=1, EN16G=0 (± 4g)		486	512	538
	GSEL1=1, GSEL0=0, EN16G=0 (± 8g)		243	256	269
	GSEL1=1, GSEL0=0, EN16G=1 (± 16g)		115	128	141
Sensitivity (8-bit) <sup>1</sup>	GSEL1=0, GSEL0=0, EN16G=0 (± 2g)	counts/g	61	64	67
	GSEL1=0, GSEL0=1, EN16G=0 (± 4g)		30	32	34
	GSEL1=1, GSEL0=0, EN16G=0 (± 8g)		15	16	17
	GSEL1=1, GSEL0=0, EN16G=1 (± 16g)		7	8	9
Sensitivity Variation from RT over Temp.		%/°C		0.01	
Self Test Output change on Activation <sup>4</sup>		g		0.5	
Mechanical Resonance (-3dB) <sup>3</sup>		Hz		3500 (xy) 1800 (z)	
Non-Linearity		% of FS		0.6	
Cross Axis Sensitivity		%		2	
Noise Density		µg / √Hz		150	

**Notes:**

- Resolution and acceleration ranges are user selectable via I<sup>2</sup>C.
- 14-bit Resolution is only available for registers 0x06h – 0x0Bh in the 8g or 16g High Resolution mode
- Resonance as defined by the dampened mechanical sensor.
- Self-test can be exercised by setting STPOL bit = 1 in INT\_CTRL\_REG1, then writing 0xCA to the SELF\_TEST register.

	<b>± 2g / 4g / 8g / 16g Tri-axis Digital Accelerometer Specifications</b>	<b>PART NUMBER:</b>  <b>KXTJ3-1058</b> <b>Rev. 0.4</b> <b>July-2016</b>
---	---	---

**Table 2. Electrical**

(specifications are for operation at 2.6V and T = 25C unless stated otherwise)

Parameters		Units	Min	Typical	Max
Supply Voltage (V <sub>dd</sub> )	Operating	V	1.71	2.6	3.6
I/O Pads Supply Voltage (V <sub>io</sub> )		V	1.7		V <sub>dd</sub>
Current Consumption	High Resolution Mode (RES = 1)	μA	145	155	165
	Low Power Mode <sup>1</sup> (RES = 0)			10	
	Disabled			0.9	
Output Low Voltage (V <sub>io</sub> < 2V) <sup>2</sup>		V	-	-	0.2 * V <sub>io</sub>
Output Low Voltage (V <sub>io</sub> > 2V) <sup>2</sup>		V	-	-	0.4
Output High Voltage		V	0.8 * V <sub>io</sub>	-	-
Input Low Voltage		V	-	-	0.2 * V <sub>io</sub>
Input High Voltage		V	0.8 * V <sub>io</sub>	-	-
Input Pull-down Current		μA		0	
Start Up Time <sup>3</sup>		ms		~1/ODR	
Power Up Time <sup>4</sup>		ms		10	
I <sup>2</sup> C Communication Rate		MHz			3.4
Output Data Rate (ODR) <sup>5</sup>		Hz	0.781	50	1600
Bandwidth (-3dB) <sup>6</sup>	RES = 0	Hz		800	
	RES = 1	Hz		ODR/2	

**Notes:**

1. Current varies with Output Data Rate (ODR) see table below.
2. For I<sup>2</sup>C communication, this assumes a minimum 1.5kΩ pull-up resistor on SCL and SDA pins.
3. Start up time is from PC1 set to valid outputs. Time varies with Output Data Rate (ODR); see chart below
4. Power up time is from V<sub>dd</sub> and IO\_V<sub>dd</sub> valid to device boot completion.
5. User selectable through I<sup>2</sup>C.
6. User selectable and dependent on ODR and RES.



# ± 2g / 4g / 8g / 16g Tri-axis Digital Accelerometer Specifications

PART NUMBER:

KXTJ3-1058  
Rev. 0.4  
July-2016

## Power-On Procedure

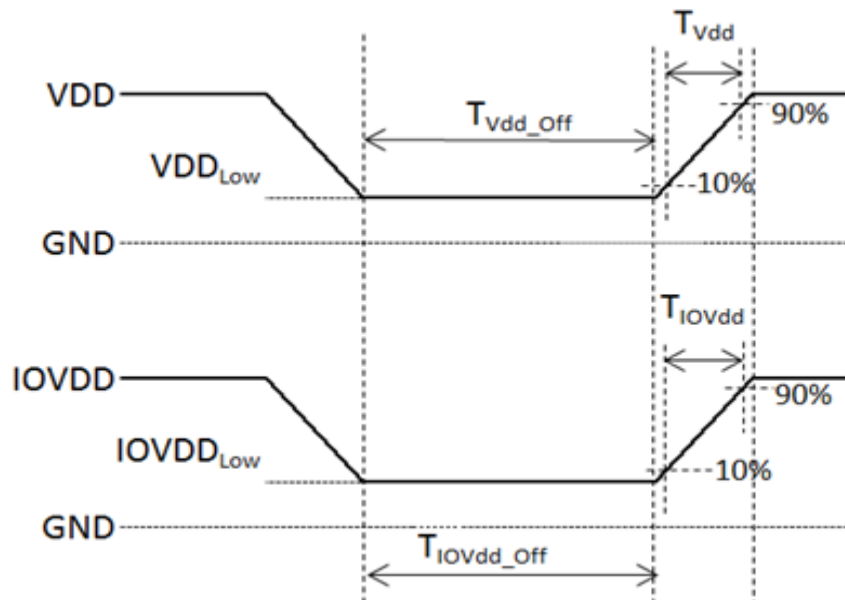

### Notes:

1. VDD and IOVDD must always be monotonic ramps without ambiguous state.
2. T<sub>Vdd</sub> is VDD rise time and T<sub>IOVdd</sub> is IOVDD rise time. T<sub>Vdd</sub> and T<sub>IOVdd</sub> rise from 10% to 90% of final value needs to be ≤ 5 ms.
3. T<sub>Vdd\_off</sub> and T<sub>IOVdd\_off</sub> are VDD and IOVDD OFF times. In order to prevent the accelerometer from entering an ambiguous state, both VDD and IOVDD need to be pulled to GND (≤ 50 mV) for a duration of time ≥ 500 ms.



# ± 2g / 4g / 8g / 16g Tri-axis Digital Accelerometer Specifications

PART NUMBER:

KXTJ3-1058  
Rev. 0.4  
July-2016

Table 3. Current Profile

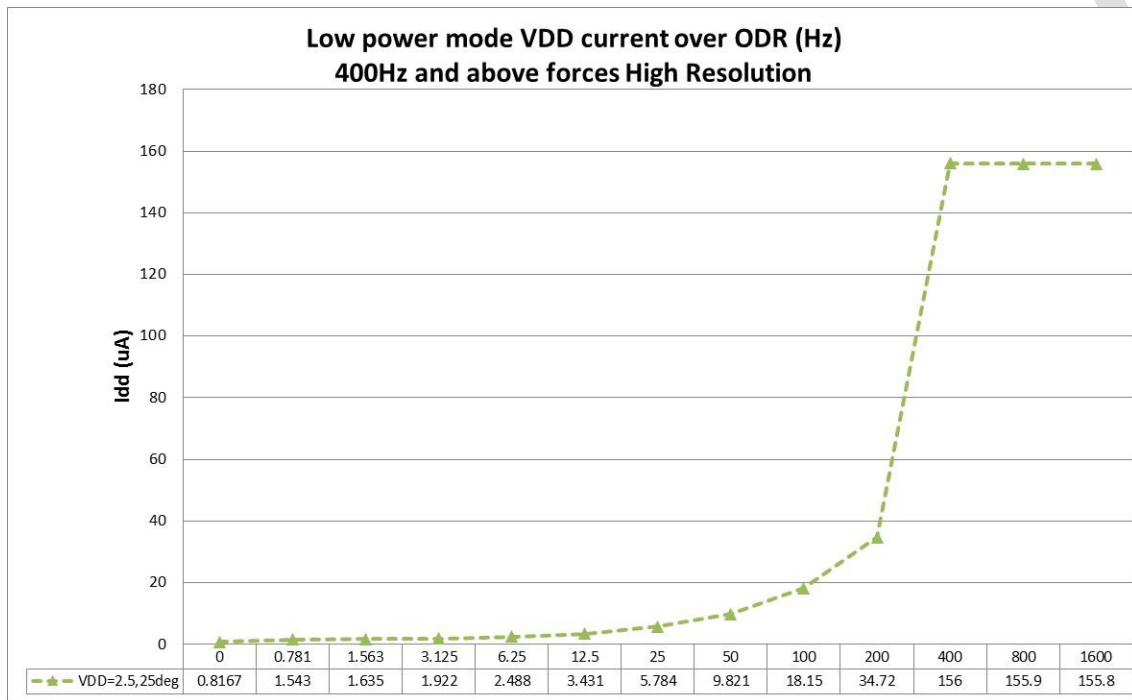



**± 2g / 4g / 8g / 16g Tri-axis Digital Accelerometer Specifications**

**PART NUMBER:**

**KXTJ3-1058  
Rev. 0.4  
July-2016**

**Table 4. Start Up Time**

RES	Mode	ODR (Hz)	Start up time (ms)
0	Low-power	0.781	2
0	Low-power	1.563	2
0	Low-power	3.125	2
0	Low-power	6.25	2
0	Low-power	12.5	2
0	Low-power	25	2
0	Low-power	50	2
0	Low-power	100	2
0	Low-power	200	2
0	Full-power	400	4
0	Full-power	800	3
0	Full-power	1600	2
1	Full-power	0.781	1281
1	Full-power	1.563	641
1	Full-power	3.125	321
1	Full-power	6.25	161
1	Full-power	12.5	81
1	Full-power	25	41
1	Full-power	50	21
1	Full-power	100	11
1	Full-power	200	6
1	Full-power	400	4
1	Full-power	800	3
1	Full-power	1600	2

	<p align="center"><b>± 2g / 4g / 8g / 16g Tri-axis Digital Accelerometer Specifications</b></p>	<p align="center"><b>PART NUMBER:</b> <b>KXTJ3-1058</b> <b>Rev. 0.4</b> <b>July-2016</b></p>
---	---	--

**Table 5. Environmental**

Parameters		Units	Min	Typical	Max
Supply Voltage (V <sub>dd</sub> )	Absolute Limits	V	-0.5	-	3.63
Operating Temperature Range		°C	-40	-	85
Storage Temperature Range		°C	-55	-	150
Mech. Shock (powered and unpowered)		g	-	-	5000 for 0.5ms 10000 for 0.2ms
ESD	HBM	V	-	-	2000



Caution: ESD Sensitive and Mechanical Shock Sensitive Component, improper handling can cause permanent damage to the device.



This product conforms to Directive 2002/95/EC of the European Parliament and of the Council of the European Union (RoHS). Specifically, this product does not contain lead, mercury, cadmium, hexavalent chromium, polybrominated biphenyls (PBB), or polybrominated diphenyl ethers (PBDE) above the maximum concentration values (MCV) by weight in any of its homogenous materials. Homogenous materials are "of uniform composition throughout."



This product is halogen-free per IEC 61249-2-21. Specifically, the materials used in this product contain a maximum total halogen content of 1500 ppm with less than 900-ppm bromine and less than 900-ppm chlorine.

**Soldering**

Soldering recommendations are available upon request or from [www.kionix.com](http://www.kionix.com).

**Floor Life**

Factory floor life exposure of the KXTJ3 reels removed from the moisture barrier bag should not exceed a maximum of 168 hours at 30C/60%RH. If this floor life is exceeded, the parts should be dried per the IPC/JEDEC J-STD-033A standard.





# ± 2g / 4g / 8g / 16g Tri-axis Digital Accelerometer Specifications

**PART NUMBER:**

**KXTJ3-1058**  
**Rev. 0.4**  
**July-2016**

## Application Schematic

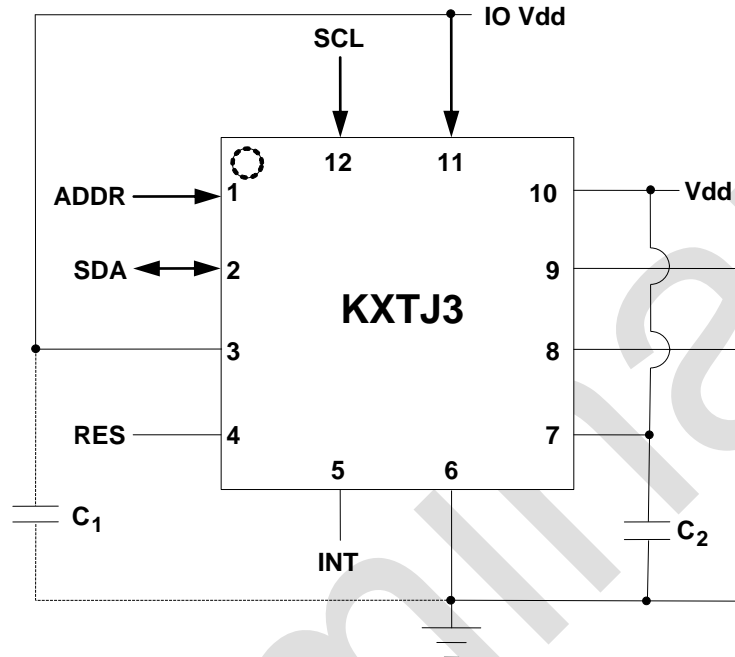

**Table 6. KXTJ3 Pin Descriptions**

Pin	Name	Description
1	ADDR	I <sup>2</sup> C programmable address bit – Connect to IO_Vdd or GND
2	SDA	I <sup>2</sup> C Serial Data
3	IO Vdd	The power supply input for the digital communication bus. Optionally decouple this pin to ground with a 0.1uF ceramic capacitor.
4	RSVD	Reserved – Connect to Vdd, IO Vdd, or GND
5	INT	Physical Interrupt
6	GND	Ground
7	Vdd	The power supply input. Decouple this pin to ground with a 0.1uF ceramic capacitor.
8	GND	Ground
9	GND	Ground
10	Vdd	The power supply input. Decouple this pin to ground with a 0.1uF ceramic capacitor.
11	IO Vdd	The power supply input for the digital communication bus. Optionally decouple this pin to ground with a 0.1uF ceramic capacitor.
12	SCL	I <sup>2</sup> C Serial Clock

	<b>± 2g / 4g / 8g / 16g Tri-axis Digital Accelerometer Specifications</b>	<b>PART NUMBER:</b>  <b>KXTJ3-1058</b> <b>Rev. 0.4</b> <b>July-2016</b>
---	---	---

## Test Specifications

### **Special Characteristics:**

These characteristics have been identified as being critical to the customer. Every part is tested to verify its conformance to specification prior to shipment.

**Table 7. Test Specifications**

Parameter	Specification	Test Conditions
Zero-g Offset @ RT	0 +/- 102 counts	25C, Vdd = 2.6 V
Sensitivity @ RT	1024 +/- 51.2 counts/g	25C, Vdd = 2.6 V
Current Consumption -- Operating	145 <= Idd <= 165 uA	25C, Vdd = 2.6 V



# ± 2g / 4g / 8g / 16g Tri-axis Digital Accelerometer Specifications

**PART NUMBER:**

**KXTJ3-1058**  
**Rev. 0.4**  
**July-2016**

## Package Dimensions and Orientation

2 x 2 x 0.9 mm LGA

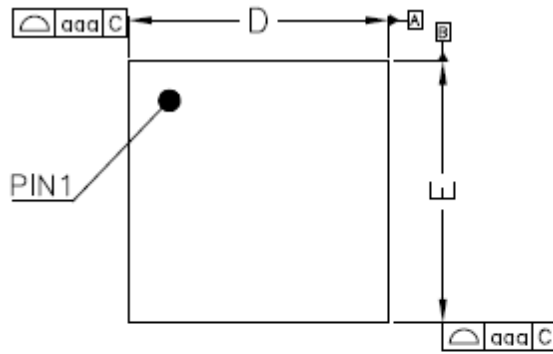

TOP VIEW

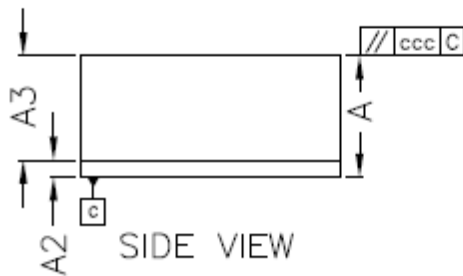

SIDE VIEW

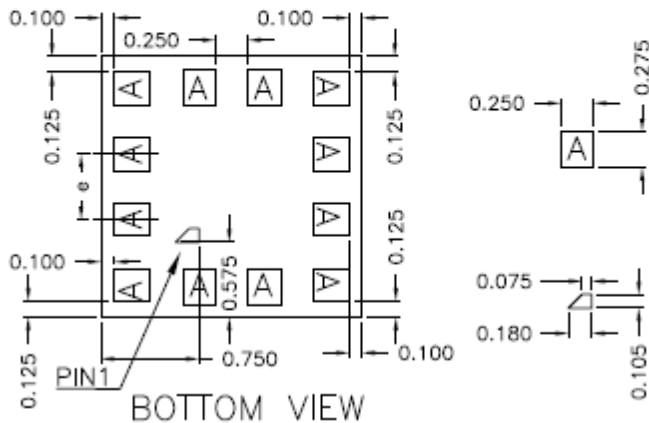

BOTTOM VIEW

ALL DIMENSIONS ARE IN MILLIMETERS.			
SYMBOL	MILLIMETER		
	MIN	NOR	MAX
A	0.88	0.93	1.00
A2	0.10	0.13	0.16
A3	0.78	0.80	0.84
D	1.95	2.00	2.05
E	1.95	2.00	2.05
e	0.50 BSC		
aaa	0.10		
ccc	0.05		

All dimensions and tolerances conform to ASME Y14.5M-1994



# ± 2g / 4g / 8g / 16g Tri-axis Digital Accelerometer Specifications

**PART NUMBER:**

**KXTJ3-1058**  
**Rev. 0.4**  
**July-2016**

## Orientation

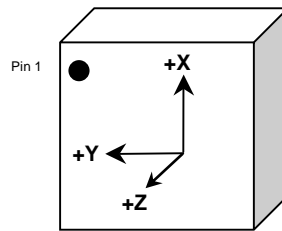

When device is accelerated in +X, +Y or +Z direction, the corresponding output will increase.

### Static X/Y/Z Output Response versus Orientation to Earth's surface (1g): GSEL1=0, GSEL0=0 (± 2g)

Position	1		2		3		4		5		6	
Diagram									Top Bottom		Bottom Top	
Resolution (bits)	12	8	12	8	12	8	12	8	12	8	12	8
X (counts)	1024	64	0	0	-1024	-64	0	0	0	0	0	0
Y (counts)	0	0	-1024	-64	0	0	1024	64	0	0	0	0
Z (counts)	0	0	0	0	0	0	0	0	1024	64	-1024	-64
X-Polarity	+		0		-		0		0		0	
Y-Polarity	0		-		0		+		0		0	
Z-Polarity	0		0		0		0		+		-	

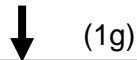

Earth's Surface



# ± 2g / 4g / 8g / 16g Tri-axis Digital Accelerometer Specifications

**PART NUMBER:**

**KXTJ3-1058**  
Rev. 0.4  
July-2016

## Static X/Y/Z Output Response versus Orientation to Earth's surface (1g): GSEL1=0, GSEL0=1 (± 4g)

Position	1		2		3		4		5		6	
Diagram									Top 		Bottom 	
Resolution (bits)	12	8	12	8	12	8	12	8	12	8	12	8
X (counts)	512	32	0	0	-512	-32	0	0	0	0	0	0
Y (counts)	0	0	-512	-32	0	0	512	32	0	0	0	0
Z (counts)	0	0	0	0	0	0	0	0	512	32	-512	-32
X-Polarity	+		0		-		0		0		0	
Y-Polarity	0		-		0		+		0		0	
Z-Polarity	0		0		0		0		+		-	

↓ (1g)

Earth's Surface

## Static X/Y/Z Output Response versus Orientation to Earth's surface (1g): GSEL1=1, GSEL0=0 (± 8g)

Position	1		2		3		4		5		6	
Diagram									Top 		Bottom 	
Resolution (bits)	12	8	12	8	12	8	12	8	12	8	12	8
X (counts)	256	16	0	0	-256	-16	0	0	0	0	0	0
Y (counts)	0	0	-256	-16	0	0	256	16	0	0	0	0
Z (counts)	0	0	0	0	0	0	0	0	256	16	-256	-16
X-Polarity	+		0		-		0		0		0	
Y-Polarity	0		-		0		+		0		0	
Z-Polarity	0		0		0		0		+		-	

↓ (1g)

Earth's Surface



# ± 2g / 4g / 8g / 16g Tri-axis Digital Accelerometer Specifications

**PART NUMBER:**

**KXTJ3-1058**  
**Rev. 0.4**  
**July-2016**

## Static X/Y/Z Output Response versus Orientation to Earth's surface (1g):

GSEL1=1, GSEL0=0 (± 16g)

Position	1		2		3		4		5		6	
Diagram									Top  Bottom		Bottom  Top	
Resolution (bits)	12	8	12	8	12	8	12	8	12	8	12	8
X (counts)	128	8	0	0	-128	-8	0	0	0	0	0	0
Y (counts)	0	0	-128	-8	0	0	128	8	0	0	0	0
Z (counts)	0	0	0	0	0	0	0	0	128	8	-128	-8
X-Polarity	+		0		-		0		0		0	
Y-Polarity	0		-		0		+		0		0	
Z-Polarity	0		0		0		0		+		-	

↓ (1g)

Earth's Surface

	<b>± 2g / 4g / 8g / 16g Tri-axis Digital Accelerometer Specifications</b>	<b>PART NUMBER:</b>  <b>KXTJ3-1058</b> <b>Rev. 0.4</b> <b>July-2016</b>
---	---	---

## KXTJ3 Digital Interface

The Kionix KXTJ3 digital accelerometer has the ability to communicate on the I<sup>2</sup>C digital serial interface bus. This allows for easy system integration by eliminating analog-to-digital converter requirements and by providing direct communication with system micro-controllers.

The serial interface terms and descriptions as indicated in Table 8. Serial Interface Terminologies below will be observed throughout this document.

Term	Description
Transmitter	The device that transmits data to the bus.
Receiver	The device that receives data from the bus.
Master	The device that initiates a transfer, generates clock signals, and terminates a transfer.
Slave	The device addressed by the Master.

**Table 8.** Serial Interface Terminologies

## I<sup>2</sup>C Serial Interface

As previously mentioned, the KXTJ3 has the ability to communicate on an I<sup>2</sup>C bus. I<sup>2</sup>C is primarily used for synchronous serial communication between a Master device and one or more Slave devices. The Master, typically a micro controller, provides the serial clock signal and addresses Slave devices on the bus. The KXTJ3 always operates as a Slave device during standard Master-Slave I<sup>2</sup>C operation.

I<sup>2</sup>C is a two-wire serial interface that contains a Serial Clock (SCL) line and a Serial Data (SDA) line. SCL is a serial clock that is provided by the Master, but can be held low by any Slave device, putting the Master into a wait condition. SDA is a bi-directional line used to transmit and receive data to and from the interface. Data is transmitted MSB (Most Significant Bit) first in 8-bit per byte format, and the number of bytes transmitted per transfer is unlimited. The I<sup>2</sup>C bus is considered free when both lines are high. The I<sup>2</sup>C interface is compliant with high-speed mode, fast mode and standard mode I<sup>2</sup>C standards.



# ± 2g / 4g / 8g / 16g Tri-axis Digital Accelerometer Specifications

PART NUMBER:

KXTJ3-1058  
Rev. 0.4  
July-2016

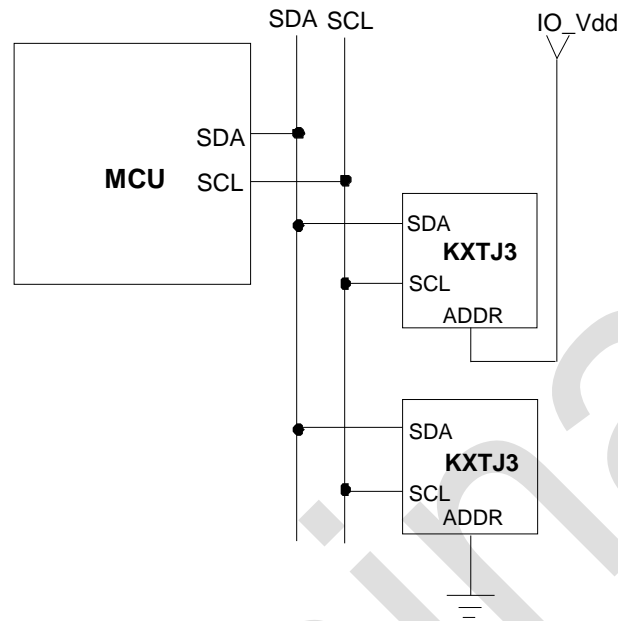



Figure 1. Multiple KXTJ3 I<sup>2</sup>C Connection

## I<sup>2</sup>C Operation

Transactions on the I<sup>2</sup>C bus begin after the Master transmits a start condition (S), which is defined as a high-to-low transition on the data line while the SCL line is held high. The bus is considered busy after this condition. The next byte of data transmitted after the start condition contains the Slave Address (SAD) in the seven MSBs (Most Significant Bits), and the LSB (Least Significant Bit) tells whether the Master will be receiving data '1' from the Slave or transmitting data '0' to the Slave. When a Slave Address is sent, each device on the bus compares the seven MSBs with its internally stored address. If they match, the device considers itself addressed by the Master. The KXTJ3's Slave Address is comprised of a programmable part and a fixed part, which allows for connection of multiple KXTJ3's to the same I<sup>2</sup>C bus. The Slave Address associated with the KXTJ3 is 000111X, where the programmable bit, X, is determined by the assignment of ADDR (pin 1) to GND or IO\_Vdd. Figure 1 above shows how two KXTJ3's would be implemented on an I<sup>2</sup>C bus.

It is mandatory that receiving devices acknowledge (ACK) each transaction. Therefore, the transmitter must release the SDA line during this ACK pulse. The receiver then pulls the data line low so that it remains stable low during the high period of the ACK clock pulse. A receiver that has been addressed, whether it is Master or Slave, is obliged to generate an ACK after each byte of data has been received. To conclude a transaction, the Master must transmit a stop condition (P) by transitioning the SDA line from low to high while SCL is high. The I<sup>2</sup>C bus is now free.



	<b>± 2g / 4g / 8g / 16g Tri-axis Digital Accelerometer Specifications</b>	<b>PART NUMBER:</b>  <b>KXTJ3-1058</b> <b>Rev. 0.4</b> <b>July-2016</b>
---	---	---

### Writing to a KXTJ3 8-bit Register

Upon power up, the Master must write to the KXTJ3's control registers to set its operational mode. Therefore, when writing to a control register on the I<sup>2</sup>C bus, as shown Sequence 1 on the following page, the following protocol must be observed: After a start condition, SAD+W transmission, and the KXTJ3 ACK has been returned, an 8-bit Register Address (RA) command is transmitted by the Master. This command is telling the KXTJ3 to which 8-bit register the Master will be writing the data. Since this is I<sup>2</sup>C mode, the MSB of the RA command should always be zero (0). The KXTJ3 acknowledges the RA and the Master transmits the data to be stored in the 8-bit register. The KXTJ3 acknowledges that it has received the data and the Master transmits a stop condition (P) to end the data transfer. The data sent to the KXTJ3 is now stored in the appropriate register. The KXTJ3 automatically increments the received RA commands and, therefore, multiple bytes of data can be written to sequential registers after each Slave ACK as shown in Sequence 2 on the following page.

### Reading from a KXTJ3 8-bit Register

When reading data from a KXTJ3 8-bit register on the I<sup>2</sup>C bus, as shown in Sequence 3 on the next page, the following protocol must be observed: The Master first transmits a start condition (S) and the appropriate Slave Address (SAD) with the LSB set at '0' to write. The KXTJ3 acknowledges and the Master transmits the 8-bit RA of the register it wants to read. The KXTJ3 again acknowledges, and the Master transmits a repeated start condition (Sr). After the repeated start condition, the Master addresses the KXTJ3 with a '1' in the LSB (SAD+R) to read from the previously selected register. The Slave then acknowledges and transmits the data from the requested register. The Master does not acknowledge (NACK) it received the transmitted data, but transmits a stop condition to end the data transfer. Note that the KXTJ3 automatically increments through its sequential registers, allowing data to be read from multiple registers following a single SAD+R command as shown below in Sequence 4 on the following page. The 8-bit register data is transmitted using a left-most format, first bit shifted/clocked out being the MSB bit.

If a receiver cannot transmit or receive another complete byte of data until it has performed some other function, it can hold SCL low to force the transmitter into a wait state. Data transfer only continues when the receiver is ready for another byte and releases SCL.

	<b>± 2g / 4g / 8g / 16g Tri-axis Digital Accelerometer Specifications</b>	<b>PART NUMBER:</b>  <b>KXTJ3-1058</b> <b>Rev. 0.4</b> <b>July-2016</b>
---	---	---

## Data Transfer Sequences

The following information clearly illustrates the variety of data transfers that can occur on the I<sup>2</sup>C bus and how the Master and Slave interact during these transfers. Table 9 defines the I<sup>2</sup>C terms used during the data transfers.

Term	Definition
S	Start Condition
Sr	Repeated Start Condition
SAD	Slave Address
W	Write Bit
R	Read Bit
ACK	Acknowledge
NACK	Not Acknowledge
RA	Register Address
Data	Transmitted/Received Data
P	Stop Condition

**Table 9.** I<sup>2</sup>C Terms

**Sequence 1.** The Master is writing one byte to the Slave.

Master	S	SAD + W		RA		DATA		P
Slave			ACK		ACK		ACK	

**Sequence 2.** The Master is writing multiple bytes to the Slave.

Master	S	SAD + W		RA		DATA		DATA		P
Slave			ACK		ACK		ACK		ACK	

**Sequence 3.** The Master is receiving one byte of data from the Slave.

Master	S	SAD + W		RA		Sr	SAD + R			NACK	P
Slave			ACK		ACK			ACK	DATA		

**Sequence 4.** The Master is receiving multiple bytes of data from the Slave.

Master	S	SAD + W		RA		Sr	SAD + R			ACK		NACK	P
Slave			ACK		ACK			ACK	DATA		DATA		

	<b>± 2g / 4g / 8g / 16g Tri-axis Digital Accelerometer Specifications</b>	<b>PART NUMBER:</b>  <b>KXTJ3-1058</b> <b>Rev. 0.4</b> <b>July-2016</b>
---	---	---

### KXTJ3 Embedded Registers

The KXTJ3 has 20 embedded 8-bit registers that are accessible by the user. This section contains the addresses for all embedded registers and also describes bit functions of each register.

Register Name	Type Read/Write	I2C Address	
		Hex	Binary
Kionix Reserved	-	0x00 – 0x05	-
XOUT_L	R	0x06	0000 0110
XOUT_H	R	0x07	0000 0111
YOUT_L	R	0x08	0000 1000
YOUT_H	R	0x09	0000 1001
ZOUT_L	R	0x0A	0000 1010
ZOUT_H	R	0x0B	0000 1011
DCST_RESP	R	0x0C	0000 1100
Kionix Reserved	-	0x0D – 0x0E	-
WHO_AM_I	R	0x0F	0000 1111
Kionix Reserved	-	0x10 – 0x15	-
INT_SOURCE1	R	0x16	0001 0110
INT_SOURCE2	R	0x17	0001 0111
STATUS_REG	R	0x18	0001 1000
Kionix Reserved	-	0x19	-
INT_REL	R	0x1A	0001 1010
CTRL_REG1*	R/W	0x1B	0001 1011
Kionix Reserved	-	0x1C	0001 1100
CTRL_REG2*	R/W	0x1D	0001 1101
INT_CTRL_REG1*	R/W	0x1E	0001 1110
INT_CTRL_REG2*	R/W	0x1F	0001 1111
Kionix Reserved	-	0x20	0010 0000
DATA_CTRL_REG*	R/W	0x21	0010 0001
Kionix Reserved	-	0x22 – 0x28	-
WAKEUP_TIMER*	R/W	0x29	0010 1001
BTS_TIMER*	R/W	0x2A	0010 1010
Kionix Reserved	-	0x2A – 0x39	-
SELF_TEST*	W	0x3A	0011 1010
Kionix Reserved	-	0x3B – 0x69	-
WAKUP_THRESHOLD*	R/W	0x6A-6B	0110 1010

\* Note: When changing the contents of these registers, the PC1 bit in CTRL\_REG1 must first be set to “0”.

**Table 10. KXTJ3 Register Map**

	<b>± 2g / 4g / 8g / 16g Tri-axis Digital Accelerometer Specifications</b>	<b>PART NUMBER:</b>  <b>KXTJ3-1058</b> <b>Rev. 0.4</b> <b>July-2016</b>
---	---	---

## KXTJ3 Register Descriptions

### Accelerometer Outputs

These registers contain up to 12-bits of valid acceleration data for each axis depending on the setting of the RES bit in CTRL\_REG1, where the acceleration outputs are represented in 12-bit valid data when RES = '1' and 8-bit valid data when RES = '0'. The data is updated every user-defined ODR period, is protected from overwrite during each read, and can be converted from digital counts to acceleration (g) per Table 11 below. The register acceleration output binary data is represented in 2's complement format. For example, if N = 12 bits, then the Counts range is from -2048 to 2047, and if N = 8 bits, then the Counts range is from -128 to 127.

12-bit Register Data (2's complement)	Equivalent Counts in decimal	Range = +/-2g	Range = +/-4g	Range = +/-8g	Range = +/-16g
0111 1111 1111	2047	+1.999g	+3.998g	+7.996g	+7.992g
0111 1111 1110	2046	+1.998g	+3.996g	+7.992g	+7.984g
...	...	...	...	...	...
0000 0000 0001	1	+0.001g	+0.002g	+0.004g	+0.008g
0000 0000 0000	0	0.000g	0.000g	0.000g	0.000g
1111 1111 1111	-1	-0.001g	-0.002g	-0.004g	-0.008g
...	...	...	...	...	...
1000 0000 0001	-2047	-1.999g	-3.998g	-7.996g	-7.992g
1000 0000 0000	-2048	-2.000g	-4.000g	-8.000g	-8.000g

8-bit Register Data (2's complement)	Equivalent Counts in decimal	Range = +/-2g	Range = +/-4g	Range = +/-8g	Range = +/-16g
0111 1111	127	+1.984g	+3.969g	+7.938g	+7.875g
0111 1110	126	+1.969g	+3.938g	+7.875g	+7.750g
...	...	...	...	...	...
0000 0001	1	+0.016g	+0.031g	+0.063g	+0.125g
0000 0000	0	0.000g	0.000g	0.000g	0.000g
1111 1111	-1	-0.016g	-0.031g	-0.063g	-0.125g
...	...	...	...	...	...
1000 0001	-127	-1.984g	-3.969g	-7.938g	-7.875g
1000 0000	-128	-2.000g	-4.000g	-8.000g	-8.000g

**Table 11. Acceleration (g) Calculation**



# ± 2g / 4g / 8g / 16g Tri-axis Digital Accelerometer Specifications

**PART NUMBER:**

**KXTJ3-1058**  
**Rev. 0.4**  
**July-2016**

## XOUT\_L

X-axis accelerometer output least significant byte

R	R	R	R	R	R	R	R
XOUTD3	XOUTD2	XOUTD1	XOUTD0	X	X	X	X
Bit7	Bit6	Bit5	Bit4	Bit3	Bit2	Bit1	Bit0
I <sup>2</sup> C Address: 0x06h							

## XOUT\_H

X-axis accelerometer output most significant byte

R	R	R	R	R	R	R	R
XOUTD11	XOUTD10	XOUTD9	XOUTD8	XOUTD7	XOUTD6	XOUTD5	XOUTD4
Bit7	Bit6	Bit5	Bit4	Bit3	Bit2	Bit1	Bit0
I <sup>2</sup> C Address: 0x07h							

## YOUT\_L

Y-axis accelerometer output least significant byte

R	R	R	R	R	R	R	R
YOUTD3	YOUTD2	YOUTD1	YOUTD0	X	X	X	X
Bit7	Bit6	Bit5	Bit4	Bit3	Bit2	Bit1	Bit0
I <sup>2</sup> C Address: 0x08h							

## YOUT\_H

Y-axis accelerometer output most significant byte

R	R	R	R	R	R	R	R
YOUTD11	YOUTD10	YOUTD9	YOUTD8	YOUTD7	YOUTD6	YOUTD5	YOUTD4
Bit7	Bit6	Bit5	Bit4	Bit3	Bit2	Bit1	Bit0
I <sup>2</sup> C Address: 0x09h							



# ± 2g / 4g / 8g / 16g Tri-axis Digital Accelerometer Specifications

**PART NUMBER:**

**KXTJ3-1058  
Rev. 0.4  
July-2016**

## ZOUT\_L

Z-axis accelerometer output least significant byte

R	R	R	R	R	R	R	R
ZOUTD3	ZOUTD2	ZOUTD1	ZOUTD0	X	X	X	X
Bit7	Bit6	Bit5	Bit4	Bit3	Bit2	Bit1	Bit0
I <sup>2</sup> C Address: 0x0Ah							

## ZOUT\_H

Z-axis accelerometer output most significant byte

R	R	R	R	R	R	R	R
ZOUTD11	ZOUTD10	ZOUTD9	ZOUTD8	ZOUTD7	ZOUTD6	ZOUTD5	ZOUTD4
Bit7	Bit6	Bit5	Bit4	Bit3	Bit2	Bit1	Bit0
I <sup>2</sup> C Address: 0x0Bh							

## DCST\_RESP

This register can be used to verify proper integrated circuit functionality. It always has a byte value of 0x55h unless the DCST bit in CTRL\_REG3 is set. At that point this value is set to 0xAAh. The byte value is returned to 0x55h after reading this register.

R	R	R	R	R	R	R	R	
DCSTR7	DCSTR6	DCSTR5	DCSTR4	DCSTR3	DCSTR2	DCSTR1	DCSTR0	Reset Value
Bit7	Bit6	Bit5	Bit4	Bit3	Bit2	Bit1	Bit0	01010101
I <sup>2</sup> C Address: 0x0Ch								

## WHO\_AM\_I

This register can be used for supplier recognition, as it can be factory written to a known byte value. The default value is 0x35h.

R	R	R	R	R	R	R	R	
WIA7	WIA6	WIA5	WIA4	WIA3	WIA2	WIA1	WIA0	Reset Value
Bit7	Bit6	Bit5	Bit4	Bit3	Bit2	Bit1	Bit0	00110101
I <sup>2</sup> C Address: 0x0Fh								



# ± 2g / 4g / 8g / 16g Tri-axis Digital Accelerometer Specifications

PART NUMBER:

KXTJ3-1058  
Rev. 0.4  
July-2016

## Interrupt Source Registers

These two registers report interrupt state changes. This data is updated when a new interrupt event occurs and each application's result is latched until the interrupt release register is read. The programmable interrupt engine can be configured to report data in an unlatched manner via the interrupt control registers.

### INT\_SOURCE1

This register reports which function caused an interrupt. Reading from the interrupt release register (INT\_REL, 0x1Ah) will clear the entire contents of this register.

R	R	R	R	R	R	R	R
0	0	0	DRDY	0	0	WUFS	0
Bit7	Bit6	Bit5	Bit4	Bit3	Bit2	Bit1	Bit0
I <sup>2</sup> C Address: 0x16h							

**DRDY** - indicates that new acceleration data (at Reg Addr 0x06h to 0x0Bh) is available. This bit is cleared when acceleration data is read or the interrupt release register (INT\_REL, 0x1Ah) is read.

0 = New acceleration data not available

1 = New acceleration data available

**WUFS** - Wake up, This bit is cleared when the interrupt source latch register (INT\_REL, 0x1Ah) is read.

0 = No motion

1 = Motion has activated the interrupt



# ± 2g / 4g / 8g / 16g Tri-axis Digital Accelerometer Specifications

**PART NUMBER:**

**KXTJ3-1058**  
**Rev. 0.4**  
**July-2016**

## INT\_SOURCE2

This register reports the axis and direction of detected motion per Table 12. This register is cleared when the interrupt source latch register (INT\_REL, 0x1Ah) is read.

R	R	R	R	R	R	R	R
0	0	XNWU	XPWU	YNWU	YPWU	ZNWU	ZPWU
Bit7	Bit6	Bit5	Bit4	Bit3	Bit2	Bit1	Bit0
I <sup>2</sup> C Address: 0x17h							

Bit	Description
XNWU	X Negative (X-) Reported
XPWU	X Positive (X+) Reported
YNWU	Y Negative (Y-) Reported
YPWU	Y Positive (Y+) Reported
ZNWU	Z Negative (Z-) Reported
ZPWU	Z Positive (Z+) Reported

**Table 12.** KXTJ3 Motion Reporting

## STATUS\_REG

This register reports the status of the interrupt.

R	R	R	R	R	R	R	R
0	0	0	INT	0	0	0	0
Bit7	Bit6	Bit5	Bit4	Bit3	Bit2	Bit1	Bit0
I <sup>2</sup> C Address: 0x18h							

**INT** reports the combined (OR) interrupt information of DRDY and WUFS in the interrupt source register (INT\_SOURCE1, 0x16h). This bit is cleared when acceleration data is read or the interrupt release register (INT\_REL, 1Ah) is read.

0 = no interrupt event

1 = interrupt event has occurred





# ± 2g / 4g / 8g / 16g Tri-axis Digital Accelerometer Specifications

**PART NUMBER:**

**KXTJ3-1058  
Rev. 0.4  
July-2016**

## INT\_REL

Latched interrupt source information (INT\_SOURCE1, 0x16h and INT\_SOURCE2, 0x17h) is cleared and physical interrupt latched pin (7) is changed to its inactive state when this register is read.

R	R	R	R	R	R	R	R
X	X	X	X	X	X	X	X
Bit7	Bit6	Bit5	Bit4	Bit3	Bit2	Bit1	Bit0
I <sup>2</sup> C Address: 0x1Ah							

	<b>± 2g / 4g / 8g / 16g Tri-axis Digital Accelerometer Specifications</b>	<b>PART NUMBER:</b>  <b>KXTJ3-1058</b> <b>Rev. 0.4</b> <b>July-2016</b>
---	---	---

### CTRL\_REG1

Read/write control register that controls the main feature set.

R/W	R/W	R/W	R/W	R/W	R/W	R/W	R/W	
PC1	RES	DRDYE	GSEL1	GSEL0	EN16G	WUFE	0	Reset Value
Bit7	Bit6	Bit5	Bit4	Bit3	Bit2	Bit1	Bit0	00000000
I <sup>2</sup> C Address: 0x1Bh								

**PC1** controls the operating mode of the KXTJ3.

- 0 = stand-by mode
- 1 = operating mode

**RES** determines the performance mode of the KXTJ3. Note that to change the value of this bit, the PC1 bit must first be set to "0".

- 0 = low current, 8-bit valid. Only available for ODR ≤ 200 Hz. Bandwidth (Hz) = 800
- 1 = Full Resolution, 12-bit or 14-bit valid. Bandwidth (Hz) = ODR/2

**DRDYE** enables the reporting of the availability of new acceleration data as an interrupt. Note that to change the value of this bit, the PC1 bit must first be set to "0".

- 0 = availability of new acceleration data is not reflected as an interrupt
- 1 = availability of new acceleration data is reflected as an interrupt

**GSEL1, GSEL0, EN16G** selects the acceleration range of the accelerometer outputs per Table 13. Note that to change the value of this bit, the PC1 bit must first be set to "0".

GSEL1	GSEL0	EN16G	Range
0	0	0	+/-2g
0	1	0	+/-4g
1	0	0	+/-8g
1	1	0	+/-8g <sup>1</sup>
0	0	1	+/-16g
0	1	1	+/-16g
1	0	1	+/-16g
1	1	1	+/-16g <sup>1</sup>

**Table 13.** Selected Acceleration Range

<sup>1</sup> This is a 14-bit mode available only in High Resolution mode and only for Registers 0x06h-0x0Bh

	<b>± 2g / 4g / 8g / 16g Tri-axis Digital Accelerometer Specifications</b>	<b>PART NUMBER:</b>  <b>KXTJ3-1058</b> <b>Rev. 0.4</b> <b>July-2016</b>
---	---	---

**WUFE** enables the Wake Up (motion detect) function. 0= disabled, 1= enabled. Note that to change the value of this bit, the PC1 bit must first be set to “0”.

0 = Wake Up function disabled

1 = Wake Up function enabled

## CTRL\_REG2

Read/write control register that provides more feature set control. Note that to properly change the value of this register, the PC1 bit in CTRL\_REG1 must first be set to “0”.

R/W	R/W	R/W	R/W	R/W	R/W	R/W	R/W	
SRST	reserved	reserved	DCST	reserved	OWUFA	OWUFB	OWUFC	Reset Value
Bit7	Bit6	Bit5	Bit4	Bit3	Bit2	Bit1	Bit0	00000000
I <sup>2</sup> C Address: 0x1Dh								

**SRST** initiates software reset, which performs the RAM reboot routine. This bit will remain 1 until the RAM reboot routine is finished.

SRST = 0 – no action

SRST = 1 – start RAM reboot routine

**DCST** initiates the digital communication self-test function.

DCST = 0 – no action

DCST = 1 – sets ST\_RESP register to 0xAAh and when ST\_RESP is read, sets this bit to 0 and sets ST\_RESP to 0x55h

**OWUFA, OWUFB, OWUFC** sets the Output Data Rate for the Wake Up function (motion detection) per Table 14 below

OWUFA	OWUFB	OWUFC	Wake Up function Output Data Rate
0	0	0	0.781Hz
0	0	1	1.563Hz
0	1	0	3.125Hz
0	1	1	6.25Hz
1	0	0	12.5Hz
1	0	1	25Hz
1	1	0	50Hz
1	1	1	100Hz

**Table 14.** Output Data Rate for Wake Up Function

	<b>± 2g / 4g / 8g / 16g Tri-axis Digital Accelerometer Specifications</b>	<b>PART NUMBER:</b>  <b>KXTJ3-1058</b> <b>Rev. 0.4</b> <b>July-2016</b>
---	---	---

### INT\_CTRL\_REG1

This register controls the settings for the physical interrupt pin (7). Note that to properly change the value of this register, the PC1 bit in CTRL\_REG1 must first be set to “0”.

R/W	R/W	R/W	R/W	R/W	R/W	R/W	R/W	
0	0	IEN	IEA	IEL	0	STPOL	0	Reset Value
Bit7	Bit6	Bit5	Bit4	Bit3	Bit2	Bit1	Bit0	00010000
I <sup>2</sup> C Address: 0x1Eh								

**IEN** enables/disables the physical interrupt pin (7)

*IEN = 0 – physical interrupt pin (7) is disabled*

*IEN = 1 – physical interrupt pin (7) is enabled*

**IEA** sets the polarity of the physical interrupt pin (7)

*IEA = 0 – polarity of the physical interrupt pin (7) is active low*

*IEA = 1 – polarity of the physical interrupt pin (7) is active high*

**IEL** sets the response of the physical interrupt pin (7)

*IEL = 0 – the physical interrupt pin (7) latches until it is cleared by reading INT\_REL*

*IEL = 1 – the physical interrupt pin (7) will transmit one pulse with a period of 0.03 - 0.05ms*

**STPOL** – Self-Test polarity. 0=negative polarity (unsupported), 1=positive polarity (supported)

### INT\_CTRL\_REG2

This register controls which axis and direction of detected motion can cause an interrupt. Note that to properly change the value of this register, the PC1 bit in CTRL\_REG1 must first be set to “0”.

R/W	R/W	R/W	R/W	R/W	R/W	R/W	R/W	
0	0	XNWUE	XPWUE	YNWUE	YPWUE	ZNWUE	ZPWUE	Reset Value
Bit7	Bit6	Bit5	Bit4	Bit3	Bit2	Bit1	Bit0	00111111
I <sup>2</sup> C Address: 0x1Fh								

**ULMODE** – Unlatched mode motion interrupt, 0=disable, 1=enable

**XNWU** - x negative (x-): 0 = disabled, 1 = enabled

**XPWU** - x positive (x+): 0 = disabled, 1 = enabled

**YNWU** - y negative (y-): 0 = disabled, 1 = enabled

**YPWU** - y positive (y+): 0 = disabled, 1 = enabled

**ZNWU** - z negative (z-): 0 = disabled, 1 = enabled

**ZPWU** - z positive (z+): 0 = disabled, 1 = enabled

	<b>± 2g / 4g / 8g / 16g Tri-axis Digital Accelerometer Specifications</b>	<b>PART NUMBER:</b>  <b>KXTJ3-1058</b> <b>Rev. 0.4</b> <b>July-2016</b>
---	---	---

## DATA\_CTRL\_REG

Read/write control register that configures the acceleration outputs. Note that to properly change the value of this register, the PC1 bit in CTRL\_REG1 must first be set to “0”.

R/W	R/W	R/W	R/W	R/W	R/W	R/W	R/W	
0	0	0	0	OSAA	OSAB	OSAC	OSAD	Reset Value
Bit7	Bit6	Bit5	Bit4	Bit3	Bit2	Bit1	Bit0	00000010
I <sup>2</sup> C Address: 0x21h								

**OSAA, OSAB, OSAC, OSAD** sets the output data rate (ODR) for the low-pass filtered acceleration outputs per Table 15.

OSAA	OSAB	OSAC	OSAD	Output Data Rate	LPF Roll-Off
1	0	0	0	0.781Hz	0.3905Hz
1	0	0	1	1.563Hz	0.781Hz
1	0	1	0	3.125Hz	1.563Hz
1	0	1	1	6.25Hz	3.125Hz
0	0	0	0	12.5Hz	6.25Hz
0	0	0	1	25Hz	12.5Hz
0	0	1	0	50Hz	25Hz
0	0	1	1	100Hz	50Hz
0	1	0	0	200Hz	100Hz
0	1	0	1	400Hz	200Hz
0	1	1	0	800Hz	400Hz
0	1	1	1	1600Hz	800Hz

**Table 15.** Acceleration Output Data Rate (ODR) and LPF Roll-Off

*Note: Output Data Rates >= 400Hz will force device into High Resolution mode*

	<b>± 2g / 4g / 8g / 16g Tri-axis Digital Accelerometer Specifications</b>	<b>PART NUMBER:</b>  <b>KXTJ3-1058</b> <b>Rev. 0.4</b> <b>July-2016</b>
---	---	---

### WAKEUP\_TIMER

This register sets the time motion must be present before a wake-up interrupt is set. Every count is calculated as 1/OWUF delay period. Note that to properly change the value of this register, the PC1 bit in CTRL\_REG1 must first be set to “0”. Valid entries are from 1 to 255, excluding the zero value.

R/W	R/W	R/W	R/W	R/W	R/W	R/W	R/W	
WUFC7	WUFC6	WUFC5	WUFC4	WUFC3	WUFC2	WUFC1	WUFC0	Reset Value
Bit7	Bit6	Bit5	Bit4	Bit3	Bit2	Bit1	Bit0	00000000
I <sup>2</sup> C Address: 0x29h								

### BTS\_TIMER

This register sets the non-activity time. Every count is calculated as 1/OWUF delay period. Note that to properly change the value of this register, the PC1 bit in CTRL\_REG1 must first be set to “0”. Valid entries are from 1 to 255, excluding the zero value.

R/W	R/W	R/W	R/W	R/W	R/W	R/W	R/W	
BTS7	BTS6	BTS5	BTS4	BTS3	BTS2	BTS1	BTS0	Reset Value
Bit7	Bit6	Bit5	Bit4	Bit3	Bit2	Bit1	Bit0	00000000
I <sup>2</sup> C Address: 0x2Ah								

### SELF\_TEST

When 0xCA is written to this register, the MEMS self-test function is enabled. Electrostatic-actuation of the accelerometer, results in a DC shift of the X, Y and Z axis outputs. Writing 0x00 to this register will return the accelerometer to normal operation.

R/W	R/W	R/W	R/W	R/W	R/W	R/W	R/W	
1	1	0	0	1	0	1	0	Reset Value
Bit7	Bit6	Bit5	Bit4	Bit3	Bit2	Bit1	Bit0	00000000
I <sup>2</sup> C Address: 0x3Ah								

### WAKEUP\_THRESHOLD

This register sets the threshold for wake-up (motion detect) interrupt is set. The KXTJ3 will ship from the factory with this value set to correspond to a change in acceleration of 0.5g (3.9mg/count). Note that to properly change the value of this register, the PC1 bit in CTRL\_REG1 must first be set to “0”.

R/W	R/W	R/W	R/W	R/W	R/W	R/W	R/W	Reset Value
WUTH11	WUTH10	WUTH9	WUTH8	WUTH7	WUTH6	WUTH5	WUTH4	00001000
WUTH3	WUTH2	WUTH1	WUTH0	0	0	0	0	00000000
Bit7	Bit6	Bit5	Bit4	Bit3	Bit2	Bit1	Bit0	
I <sup>2</sup> C Address:								0x6Ah – 0x6Bh

	<b>± 2g / 4g / 8g / 16g Tri-axis Digital Accelerometer Specifications</b>	<b>PART NUMBER:</b>  <b>KXTJ3-1058</b> <b>Rev. 0.4</b> <b>July-2016</b>
---	---	---

## KXTJ3 Embedded Wake Up Function

The Motion interrupt feature of the KXTJ3 reports qualified changes in the high-pass filtered acceleration based on the WAKEUP\_THRESHOLD. If the high-pass filtered acceleration on any axis is greater than the user-defined WAKEUP\_THRESHOLD, the device has transitioned from an inactive state to an active state. Equations 1 and 2 show how to calculate the engine threshold (WAKEUP\_THRESHOLD) and delay time (WAKEUP\_TIMER) register values for the desired result.

$$WAKEUP\_THRESHOLD \text{ (counts)} = \text{Desired Threshold (g)} \times 16 \text{ (counts/g)}$$

### Equation 1. Wake Up Threshold

An 8-bit raw unsigned value represents a counter that permits the user to qualify each active/inactive state change. Note that each WAKEUP\_TIMER count qualifies 1 (one) user-defined ODR period (OWUF). Equation 2 shows how to calculate the WAKEUP\_TIMER register value for a desired wake up delay time.

$$WAKEUP\_TIMER \text{ (counts)} = \text{Desired Delay Time (sec)} \times OWUF \text{ (Hz)}$$

### Equation 2. Wake Up Delay Time

The latched motion interrupt response algorithm works as following: while the part is in inactive state, the algorithm evaluates differential measurement between each new acceleration data point with the preceding one and evaluates it against the WAKEUP\_THRESHOLD threshold. When the differential measurement is greater than WAKEUP\_THRESHOLD threshold, the wakeup counter starts the count. Differential measurements are now calculated based on the difference between the current acceleration and the acceleration when the counter started. The part will report that motion has occurred at the end of the count assuming each differential measurement has remained above the threshold. If at any moment during the count the differential measurement falls below the threshold, the counter will stop the count and the part will remain in inactive state.

To illustrate how the algorithm works, consider the Figure 2 below that shows the latched response of the motion detection algorithm with WAKEUP\_TIMER set to 10 counts. Note how the difference between the acceleration sample marked in red and the one marked in green resulted in a differential measurements represented with orange bar being above the WAKEUP\_THRESHOLD. At this point, the counter begins to count number of counts stored in WAKEUP\_TIMER register and the wakeup algorithm will evaluate the difference between each new acceleration measurement and the measurement marked in green that will remain a reference measurement for the duration of the counter count. At the end of the count, assuming all differential measurements were larger than WAKEUP\_THRESHOLD, as is the case in the example showed in Figure 2, a motion event will be reported.

	<p align="center"><b>± 2g / 4g / 8g / 16g Tri-axis Digital Accelerometer Specifications</b></p>	<p><b>PART NUMBER:</b> KXTJ3-1058 Rev. 0.4 July-2016</p>
---	---	--

Figure 2 below shows the latched response of the Wake Up Function with WUF Timer = 10 counts.



**Figure 2.** Latched Motion Interrupt Response

The KXTJ3 wake-up function is always latched unless NLMODE = 1. If NLMODE = 0 and if the INT\_CTRL\_REG1 is set with IEL = 1, then upon a wake-up event the WUF interrupt signal will pulse and return low, but only once. The WUF interrupt output will not reset until a read of the INT\_REL latch reset register.

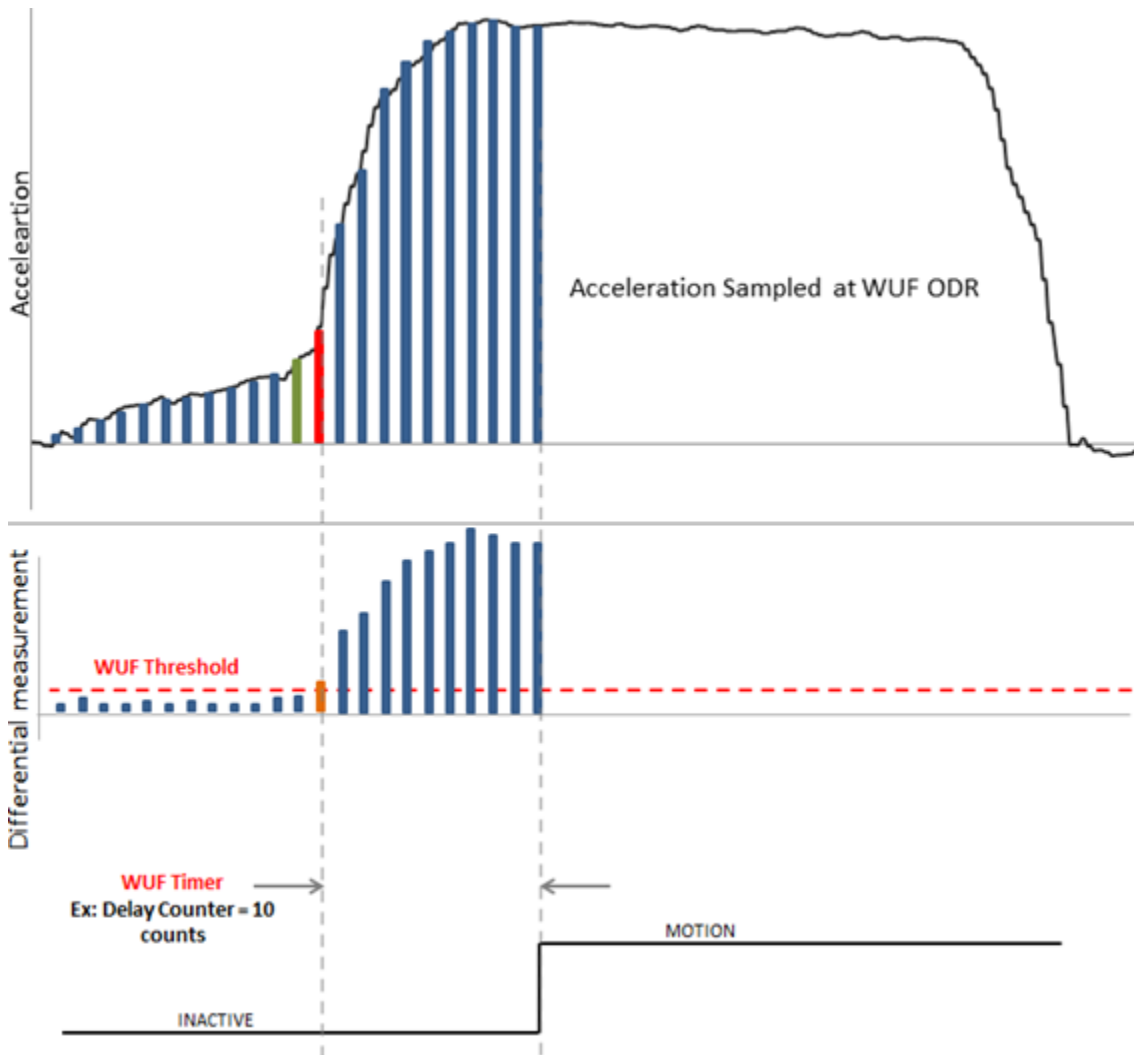

	<p align="center"><b>± 2g / 4g / 8g / 16g Tri-axis Digital Accelerometer Specifications</b></p>	<p align="center"><b>PART NUMBER:</b> <b>KXTJ3-1058</b> <b>Rev. 0.4</b> <b>July-2016</b></p>
---	---	--

## Notice

### Precaution on using KIONIX Products

- Our Products are designed and manufactured for application in ordinary electronic equipment (such as AV equipment, OA equipment, telecommunication equipment, home electronic appliances, amusement equipment, etc.). If you intend to use our Products in devices requiring extremely high reliability (such as medical equipment (Note 1), transport equipment, traffic equipment, aircraft/spacecraft, nuclear power controllers, fuel controllers, car equipment including car accessories, safety devices, etc.) and whose malfunction or failure may cause loss of human life, bodily injury or serious damage to property (“Specific Applications”), please consult with the KIONIX sales representative in advance. Unless otherwise agreed in writing by KIONIX in advance, KIONIX shall not be in any way responsible or liable for any damages, expenses or losses incurred by you or third parties arising from the use of any KIONIX’s Products for Specific Applications.

(Note1) Medical Equipment Classification of the Specific Applications

JAPAN	USA	EU	CHINA
CLASS III	CLASS III	CLASS II b	CLASS III
CLASS IV		CLASS III	

- KIONIX designs and manufactures its Products subject to strict quality control system. However, semiconductor products can fail or malfunction at a certain rate. Please be sure to implement, at your own responsibilities, adequate safety measures including but not limited to fail-safe design against the physical injury, damage to any property, which a failure or malfunction of our Products may cause. The following are examples of safety measures:
  - Installation of protection circuits or other protective devices to improve system safety
  - Installation of redundant circuits to reduce the impact of single or multiple circuit failure
- Our Products are designed and manufactured for use under standard conditions and not under any special or extraordinary environments or conditions, as exemplified below. Accordingly, KIONIX shall not be in any way responsible or liable for any damages, expenses or losses arising from the use of any KIONIX’s Products under any special or extraordinary environments or conditions. If you intend to use our Products under any special or extraordinary environments or conditions (as exemplified below), your independent verification and confirmation of product performance, reliability, etc., prior to use, must be necessary:
  - Use of our Products in any types of liquid, including water, oils, chemicals, and organic solvents
  - Use of our Products outdoors or in places where the Products are exposed to direct sunlight or dust
  - Use of our Products in places where the Products are exposed to sea wind or corrosive gases, including Cl<sub>2</sub>, H<sub>2</sub>S, NH<sub>3</sub>, SO<sub>2</sub>, and NO<sub>2</sub>
  - Use of our Products in places where the Products are exposed to static electricity or electromagnetic waves
  - Use of our Products in proximity to heat-producing components, plastic cords, or other flammable items
  - Sealing or coating our Products with resin or other coating materials
  - Use of our Products without cleaning residue of flux (even if you use no-clean type fluxes, cleaning residue of flux is recommended); or Washing our Products by using water or water-soluble cleaning agents for cleaning residue after soldering
  - Use of the Products in places subject to dew condensation
- The Products are not subject to radiation-proof design.
- Please verify and confirm characteristics of the final or mounted products in using the Products.

	<p align="center"><b>± 2g / 4g / 8g / 16g Tri-axis Digital Accelerometer Specifications</b></p>	<p align="center"><b>PART NUMBER:</b>  KXTJ3-1058 Rev. 0.4 July-2016</p>
---	---	--

6. In particular, if a transient load (a large amount of load applied in a short period of time, such as pulse. is applied, confirmation of performance characteristics after on-board mounting is strongly recommended. Avoid applying power exceeding normal rated power; exceeding the power rating under steady-state loading condition may negatively affect product performance and reliability.
7. De-rate Power Dissipation (Pd) depending on ambient temperature (Ta). When used in sealed area, confirm the actual ambient temperature.
8. Confirm that operation temperature is within the specified range described in the product specification.
9. KIONIX shall not be in any way responsible or liable for failure induced under deviant condition from what is defined in this document.

### **Precaution for Mounting / Circuit board design**

1. When a highly active halogenous (chlorine, bromine, etc.) flux is used, the residue of flux may negatively affect product performance and reliability.
2. In principle, the reflow soldering method must be used; if flow soldering method is preferred, please consult with the KIONIX representative in advance.

For details, please refer to KIONIX Mounting specification.

### **Precautions Regarding Application Examples and External Circuits**

1. If change is made to the constant of an external circuit, please allow a sufficient margin considering variations of the characteristics of the Products and external components, including transient characteristics, as well as static characteristics.
2. You agree that application notes, reference designs, and associated data and information contained in this document are presented only as guidance for Products use. Therefore, in case you use such information, you are solely responsible for it and you must exercise your own independent verification and judgment in the use of such information contained in this document. KIONIX shall not be in any way responsible or liable for any damages, expenses or losses incurred by you or third parties arising from the use of such information.

### **Precaution for Electrostatic**

This Product is electrostatic sensitive product, which may be damaged due to electrostatic discharge. Please take proper caution in your manufacturing process and storage so that voltage exceeding the Products maximum rating will not be applied to Products. Please take special care under dry condition (e.g. Grounding of human body / equipment / solder iron, isolation from charged objects, setting of Ionizer, friction prevention and temperature / humidity control).

### **Precaution for Storage / Transportation**

1. Product performance and soldered connections may deteriorate if the Products are stored in the places where:
  - a) the Products are exposed to sea winds or corrosive gases, including Cl<sub>2</sub>, H<sub>2</sub>S, NH<sub>3</sub>, SO<sub>2</sub>, and NO<sub>2</sub>
  - b) the temperature or humidity exceeds those recommended by KIONIX
  - c) the Products are exposed to direct sunshine or condensation
  - d) the Products are exposed to high Electrostatic
2. Even under KIONIX recommended storage condition, solderability of products out of recommended storage time period may be degraded. It is strongly recommended to confirm solderability before using Products of which storage time is exceeding the recommended storage time period.
3. Store / transport cartons in the correct direction, which is indicated on a carton with a symbol. Otherwise bent leads may occur due to excessive stress applied when dropping of a carton.

	<b>± 2g / 4g / 8g / 16g Tri-axis Digital Accelerometer Specifications</b>	<b>PART NUMBER:</b>  <b>KXTJ3-1058</b> <b>Rev. 0.4</b> <b>July-2016</b>
---	---	---

4. Use Products within the specified time after opening a humidity barrier bag. Baking is required before using Products of which storage time is exceeding the recommended storage time period.

**Precaution for Product Label**

QR code printed on KIONIX Products label is for KIONIX’s internal use only.

**Precaution for Disposition**

When disposing Products please dispose them properly using an authorized industry waste company.

**Precaution for Foreign Exchange and Foreign Trade act**

Since our Products might fall under controlled goods prescribed by the applicable foreign exchange and foreign trade act, please consult with KIONIX representative in case of export.

**Precaution Regarding Intellectual Property Rights**

1. All information and data including but not limited to application example contained in this document is for reference only. KIONIX does not warrant that foregoing information or data will not infringe any intellectual property rights or any other rights of any third party regarding such information or data. KIONIX shall not be in any way responsible or liable for infringement of any intellectual property rights or other damages arising from use of such information or data.
2. No license, expressly or implied, is granted hereby under any intellectual property rights or other rights of KIONIX or any third parties with respect to the information contained in this document.

**Other Precaution**

1. This document may not be reprinted or reproduced, in whole or in part, without prior written consent of KIONIX.
2. The Products may not be disassembled, converted, modified, reproduced or otherwise changed without prior written consent of KIONIX.
3. In no event shall you use in any way whatsoever the Products and the related technical information contained in the Products or this document for any military purposes, including but not limited to, the development of mass-destruction weapons.
4. The proper names of companies or products described in this document are trademarks or registered trademarks of KIONIX, its affiliated companies or third parties.

**General Precaution**

1. Before you use our Products, you are requested to carefully read this document and fully understand its contents. KIONIX shall not be in any way responsible or liable for failure, malfunction or accident arising from the use of any KIONIX’s Products against warning, caution or note contained in this document.
2. All information contained in this document is current as of the issuing date and subject to change without any prior notice. Before purchasing or using KIONIX’s Products, please confirm the latest information with a KIONIX sales representative.
3. The information contained in this document is provided on an “as is” basis and KIONIX does not warrant that all information contained in this document is accurate and/or error-free. KIONIX shall not be in any way responsible or liable for any damages, expenses or losses incurred by you or third parties resulting from inaccuracy or errors of or concerning such information.

	<b>± 2g / 4g / 8g / 16g Tri-axis Digital Accelerometer Specifications</b>	<b>PART NUMBER:</b> <b>KXTJ3-1058</b> <b>Rev. 0.4</b> <b>July-2016</b>
---	---	---

### Revision History

REVISION	DESCRIPTION	DATE
0.1	Initial Release	31-May-2016
0.2	Updated BTS register description, watermark and 1058 suffix.	14-June-2016
0.3	Added EN16G in Table 1 and 13. Removed negative Self Test and set target to 0.5g for XYZ.	1-July-2016
0.4	Improved Zero-g Offset tolerance to +/-100mg 16g Sensitivity Margin increased to 10%	7-July-2016

"Kionix" is a registered trademark of Kionix, Inc. Products described herein are protected by patents issued or pending. No license is granted by implication or otherwise under any patent or other rights of Kionix. The information contained herein is believed to be accurate and reliable but is not guaranteed. Kionix does not assume responsibility for its use or distribution. Kionix also reserves the right to change product specifications or discontinue this product at any time without prior notice. This publication supersedes and replaces all information previously supplied.

## X-ON Electronics

Largest Supplier of Electrical and Electronic Components

*Click to view similar products for [rohm](#) manufacturer:*

Other Similar products are found below :

[R6015ENZC8](#) [BP5034D24](#) [BP5013](#) [BP5011](#) [BP5718A12](#) [RPI-441C1](#) [R6035ENZC8](#) [RN142ZST2R](#) [RB520S-40TE61](#) [RB886YT2R](#)  
[RB851YT2R](#) [MCR100JZHF30R1](#) [MCR100JZHJ150](#) [MCR50JZHFLR820](#) [MCR50JZHJ330](#) [ML610Q793-SDK](#) [MNR34J5ABJ223](#)  
[BD450M2WFP3-CE2](#) [BD750L2FP-EVK-301](#) [BD9009HFP-EVK-001](#) [BD9285F-GE2](#) [SML-810TBT86](#) [RB168L-60TE25](#) [MCR100JZHF1301](#)  
[MCR100JZHJ4R3](#) [MCR100JZHJ513](#) [MCR100JZHJ683](#) [BD7682FJ-LB-EVK-402](#) [BD9B300MUV-EVK-001](#) [MNR12ERAPJ100](#)  
[RF1501TF3S](#) [MNR34J5ABJ221](#) [BD9060HFP-EVK-001](#) [BD9611MUV-EVK-001](#) [BD9C601EFJ-EVK-001](#) [BD9D321EFJ-EVK-101](#)  
[BA7603F-E2](#) [BD95820N-LB](#) [BD9A100MUV-EVK-001](#) [BD9C401EFJ-EVK-001](#) [BD9C501EFJ-EVK-001](#) [BU90005GWZ-E2-EVK-101](#)  
[BH1715FVC-TR](#) [LA-401XD](#) [SLA560WBD2PT2](#) [BH1790GLC-EVK-001](#) [RB558WMFHTL](#) [BU33UV7NUX-EVK-101](#) [BD9B301MUV-](#)  
[EVK-101](#) [BA7071F-E2](#)