

# SPECIFICATION

PRODUCTS: FIXED THICK FILM CHIP RESISTORS

TYPE: MCR01 MRT SERIES

ROHM CO., LTD . RESISTOR DIV .

DESIGN	CHECK	APPROVAL	DATE: 4/NOV/2011	SPECIFICATION No. : M C R 0 1 R - 1 A
<i>J. adachi</i>	<i>M. H. H.</i>	<i>Tora Tsubada</i>	REV. 0 0 2 E	<b>ROHM Co.,Ltd.</b>

## &lt; Specifications (Precautions and Prohibitions) &gt;

**Safety Precautions**

- 1) The products are designed and produced for application in ordinary electronic equipment (AV equipment, OA equipment, telecommunication equipment, home appliances, amusement equipment, etc.).  
If the products are to be used in devices requiring extremely high reliability (medical equipment, transport equipment, aircraft/spacecraft, nuclear power controllers, fuel controllers, car equipment including car accessories, safety devices, etc.) and whose malfunction or operational error may endanger human life and sufficient fail-safe measures, please consult with the ROHM sales staff in advance. If product malfunctions may result in serious damage, including that to human life, sufficient fail-safe measures must be taken, including the following:
  - [a] Installation of protection circuits or other protective devices to improve system safety
  - [b] Installation of redundant circuits in the case of single-circuit failure
- 2) The products are designed for use in a standard environment and not in any special environments. Application of the products in a special environment can deteriorate product performance. Accordingly, verification and confirmation of product performance, prior to use, is recommended if used under the following conditions:
  - [a] Use in various types of liquid, including water, oils, chemicals, and organic solvents
  - [b] Use outdoors where the products are exposed to direct sunlight, or in dusty places
  - [c] Use in places where the products are exposed to sea winds or corrosive gases, including Cl<sub>2</sub>, H<sub>2</sub>S, NH<sub>3</sub>, SO<sub>2</sub>, and NO<sub>2</sub>
  - [d] Use in places where the products are exposed to static electricity or electromagnetic waves
  - [e] Use in proximity to heat-producing components, plastic cords, or other flammable items
  - [f] Use involving sealing or coating the products with resin or other coating materials
  - [g] Use involving unclean solder or use of water or water-soluble cleaning agents for cleaning after soldering
  - [h] Use of the products in places subject to dew condensation
- 3) The products are not radiation resistant.
- 4) Verification and confirmation of performance characteristics of product, after on-board mounting, is advised.
- 5) In particular, if a transient load (a large amount of load applied in a short period of time, such as pulse) is applied, confirmation of performance characteristics after on-board mounting is strongly recommended. Avoid applying power exceeding normal rated power; exceeding the power rating under steady-state loading condition may negatively affect product performance and reliability.
- 6) De-rate Power Dissipation(P<sub>d</sub>) depending on Ambient temperature(T<sub>a</sub>).
- 7) Confirm that operation temperature is within the specified range described in product specification.
- 8) Product may be damaged when the impact, such as downfall is given.
- 9) Failure induced under deviant condition from what defined in the product specification can be not be Guaranteed.
- 10) When product safety related problems arises, please immediately inform to ROHM, and consider technical counter measure.

**< Specifications (Precautions and Prohibitions) >**
**Precaution for Mounting/Circuit board design**

- 1) When a highly active halogenous (chlorine, bromine, etc.)flux is used, the remainder of flux may negatively affect product performance and reliability.
- 2)In principle, the reflow soldering method must be used; if flow soldering method is preferred,please Consult with the company in advance.
- 3) Pay attention to the soldering condition in order to avoid problems due to silver absorption into solder.
- 4) Be careful when pick up the products with tweezers.  
There may be a case that the overcoat and /or the body can be chipped.
- 5) Soldering tip shall not touch the product when install product manually.

**Precautions Regarding Application Examples and External Circuits**

- 1) If change is made to the constant of an external circuit, allow a sufficient margin due to variations of the characteristics of the products and external components, including transient characteristics, as well as static characteristics.
- 2) The application examples, their constants, and other types of information contained herein are applicable only when the products are used in accordance with standard methods. Therefore, if mass production is intended, sufficient consideration to external conditions must be made.

**Precaution for Electrostatic**

This product is Electrostatic sensitive product, which may be damaged due to Electrostatic discharge. Please take proper caution during manufacturing and string so that voltage exceeding Product maximum rating won't be applied to products. Please take special care under dry condition(e.g. Grounding of human body /equipment /solder iron, isolation from charged objects, setting of Ionizer, friction prevention and temperature /humidity control).

**Precaution for strage/Transportation**

- 1)Product performance and soldered connections may deteriorate if the products are stored in the following places:
  - [a] Where the products are exposed to sea winds or corrosive gases, including Cl<sub>2</sub>, H<sub>2</sub>S, NH<sub>3</sub>, SO<sub>2</sub>, and NO<sub>2</sub>
  - [b] Where the temperature or humidity exceeds those recommended by the Company  
Temperature:5 40 , Humidity 30 80% (Put condition for individual product)
  - [c] Storage in direct sunshine or condensation
  - [d] Storage in high Electrostatic
- 2) Even under ROHM recommended storage condition, solderability of products over 1 year old (Put condition for each product)may be degraded.  
It is strongly recommended storage time period.  
• Recommended storage condition : Temperature 5 40 , Humidity 30 80%(Put condition for individual product)
- 3) Store / transport cartons in the correct direction, which is indicated on a carton as a symbol.  
Otherwise bent leads may occur due to excessive stress applied when dropping of a carton..

**Precaution for product label**

QR code printed on ROHM product label is only for internal use, and please do not use at customer site. It might contain a internal part number that is inconsistent with an product part number.

**Precaution for disposition**

When disposing products please dispose them properly with a industry waste company.

**Precautions for Foreign exchange control regulation**

ROHM has not determined whether or not the products are considered "a controlled product or labor " as specified in the Foreign Exchange and Foreign Trade Control Law. Accordingly, if exportation of the products, either separately or integrated in another company's products, is intended, or giving the products to persons who are not residents is planed, additional steps are required, based upon the appropriate regulations.

## &lt; Specifications (Precautions and Prohibitions) &gt;

**Prohibitions Regarding Industrial Property**

- 1) These Specifications contain information related to the ROHM industrial property. Any use of them other than pertaining to the usage of appropriate products is not permitted. Duplication of these Specifications and its disclosure to a third party without the Company's permission is prohibited.
- 2) Information and data on products, including application examples, contained in these specifications are simply for reference; the Company does not guarantee any industrial property rights, intellectual property rights, or any other rights of a third party regarding this information or data. Accordingly, the Company does not bear any responsibility for:
  - [a] infringement of the intellectual property rights of a third party
  - [b] any problems incurred by the use of the products listed herein.
- 3) The Company prohibits the purchaser of its products to exercise or use the intellectual property rights, industrial property rights, or any other rights that either belong to or are controlled by the Company, other than the right to use, sell, or dispose of the products.

**Other Matters**

- 1) Please sign these Specifications and return one copy to the Company.  
If a copy is not returned within three months after the issued date specified on the front page of these Specifications, the Company will consider the Specifications accepted.
- 2) If any matter related to these Specifications needs to be clarified, discussions shall be held promptly between the two parties concerned to determine the issue.

**1.SCOPE**

This specification covers the characteristics of “MCR01 series (including jumper type)” based of thick film chip resistors in ROHM Co., Ltd. products.

**2.CLASSIFICATION**

MCR01                      MRT                      J \*                      ( ) \*  
TYPE                      PACKAGING CODE                      TOLERANCE                      RESISTANCE  
VALUE(IEC CODE)

\* Jumper is 「J 000」

PACKAGING CODE	PACKAGE	QUANTITY
MRT	180mm( 7inch)reel, paper tape(2mm pitch)	10,000pcs/reel

TOLERANCE	D (±0.5%)	F (±1%)	J (±5%)

RESISTANCE VALUE

4digits	D	F
3digits	J	

**3.RATING**

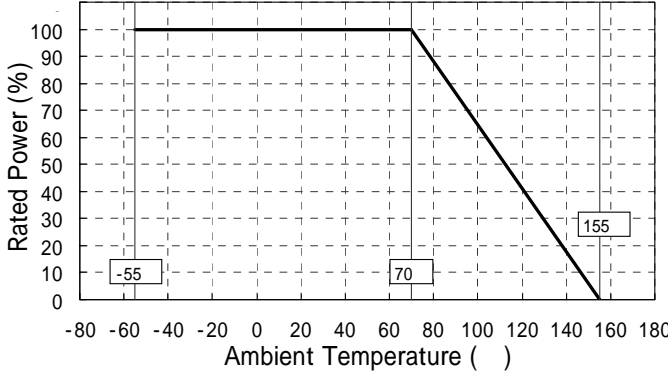
ITEMS	CONDITIONS	SPECIFICATIONS
RATED POWER	For resistors operated at the ambient temperature in excess of 70 , the load shall be derated in accordance with <u>Fig.1</u> <u>Fig.1</u> 	0.063W(1/16W) at 70
RATED VOLTAGE	Rated voltage is determined from the following. When rated voltage exceeds the limiting element voltage, the limiting element voltage shall be the rated voltage.  $E = \sqrt{P \times R}$ E: RATED VOLTAGE (V) P: RATED POWER (W) R: RESISTANCE ( )	LIMITING ELEMENT VOLTAGE      50V
RESISTANCE	See <u>Table.1</u>	
TEMPERATURE		-55 ~ +155

Jumper type

RESISTANCE	MAX.50m
RATED CURRENT	1A
TEMPERATURE RANGE	-55 ~ +155

Table.1

TOLERANCE	RESISTANCE RANGE ( )	TEMPERATURE(ppm/ ) COEFFICIENT
D (± 0.5%)	10 R 1M (E24)	± 100
F (± 1%)	10 R < 1M (E24,E96)	± 100
	1M R 2.2M (E24,E96)	± 200
J (± 5%)	1.0 R < 10 (E24)	+ 500 / - 250
	10 R 10M (E24)	± 200

**4.CHARACTERISTICS**

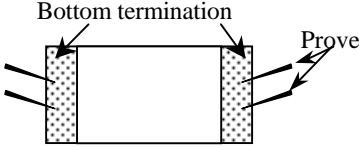
ITEMS	GUARANTEED VALUE		TEST CONDITIONS (JIS C 5201-1)
	RESISTOR TYPE	JUMPER TYPE	
4.1 RESISTANCE	D: $\pm 0.5\%$ F: $\pm 1\%$ J: $\pm 5\%$	MAX. 5 0 m	JIS C 5201-1 4.5 Measuring method : Measure bottom termination by 4 probes. 
4.2 VARIATION OF RESISTANCE WITH TEMPERATURE	See <a href="#">Table.1</a>		JIS C 5201-1 4.8 Measurement : +25/+125 Mounting condition: See <a href="#">Fig.3</a>
4.3 OVERLOAD	$\pm (2.0\% + 0.1 )$	MAX. 5 0 m	JIS C 5201-1 4.13 Rated voltage(current) $\times 2.5$ , 2s Limiting Element Voltage $\times 2$ : 100 V Mounting condition: See <a href="#">Fig.3</a>
4.4 SOLDERABILITY	A new uniform coating of minimum of 95% of the surface being immersed and no soldering damage.		JIS C 5201-1 4.17 Rosin· Ethanol(25% WT) Soldering condition : $235 \pm 5$ Duration of immersion : $2.0 \pm 0.5s$ .
4.5 RESISTANCE TO SOLDERING HEAT	$\pm (1.0\% + 0.05 )$ No remarkable abnormality on the appearance.	MAX. 5 0 m	JIS C 5201-1 4.18 Soldering condition : $260 \pm 5$ Duration of immersion : $10 \pm 1s$ .
4.6 RAPID CHANGE OF TEMPERATURE	$\pm (1.0\% + 0.05 )$	MAX. 5 0 m	JIS C 5201-1 4.19 Test temp. : -55 ~ +125 300cycle Mounting condition: See <a href="#">Fig.3</a>
4.7 DAMP HEAT, STEADY STATE	$\pm (3.0\% + 0.1 )$	MAX. 1 0 0 m	JIS C 5201-1 4.24 40 , 93%RH Test time : 1,000h ~ 1,048h Mounting condition: See <a href="#">Fig.3</a>
4.8 ENDURANCE AT 70	$\pm (3.0\% + 0.1 )$	MAX. 1 0 0 m	JIS C 5201-1 4.25.1 Rated voltage(current),70 1.5h:ON - 0.5h:OFF Test time : 1,000h ~ 1,048h Mounting condition: See <a href="#">Fig.3</a>
4.9 ENDURANCE	$\pm (3.0\% + 0.1 )$	MAX. 1 0 0 m	JIS C 5201 -1 4.25.3 155 Test time : 1,000h ~ 1,048h Mounting condition: See <a href="#">Fig.3</a>
4.10 RESISTANCE TO SOLVENT	$\pm (1.0\% + 0.05 )$	MAX. 5 0 m	JIS C 5201-1 4.29 $23 \pm 5$ , Immersion cleaning, $5 \pm 0.5min$ Solvent: 2-propanol
4.11 BEND STRENGTH OF THE END FACE PLATING	$\pm (1.0\% + 0.05 )$ Without mechanical damage such as breaks.	MAX. 5 0 m	JIS C 5201-1 4.33 Mounting condition: See <a href="#">Fig.4</a>

\* In the items on characteristics, the expression " $\pm (1.0\% + 0.05 )$ " is used in the column for standard values.

However, this is because of dramatic increase in the fluctuation ratio that can be take place in the low resistance value range and is not meant to supplement the measuring accuracy of the measuring instruments.

Accordingly, there is a need to increase the design tolerance in the low resistance value range.

5 . DIMENSIONS & CONSTRUCTION

Fig.2

(UNIT: mm)

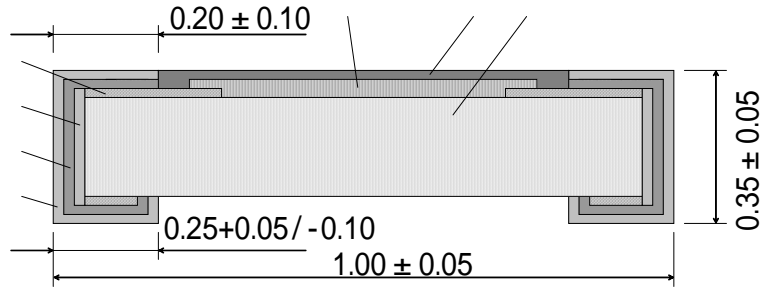

MATERIAL	
	Resistive element
	Silver thick film electrode
	Nickel-Chrome electrode
	Nickel electrode
	Sn electrode
	Alumina substrate
	Over coating (Resin)

6 . MARKINGS

6 . 1 Markings on chip resistor

There is no marking on the chip resistor.

6 . 2 Marking on the packaging container

The following items will be displayed on the smallest unit of the container used for Packaging.

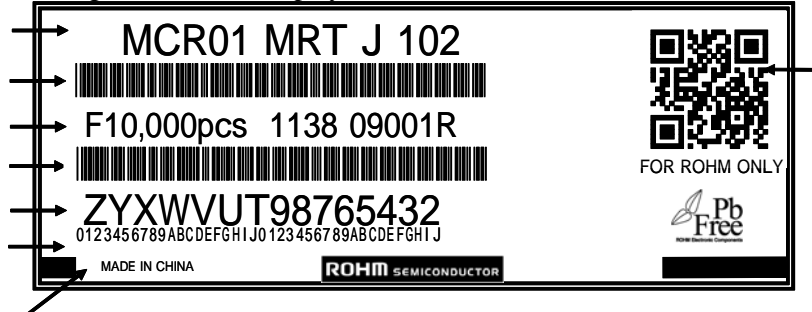

- Type + Packaging code + Tolerance + Resistance value
- Bar code of type code + Resistance value
- Special code + Quantity + Lot No.  
(There may be label with and without special code.)
- Bar code of Quantity + Lot No.
- Code for ROHM internal use (This code is not always same as )
- Part No. + Order No.  
(To be executed on necessity)
- The country of origin.
- QR code (Only for ROHM internal use)

7 . APPEARANCE QUALITY

An appearance inspection of the surface should reveal no obvious abnormalities.

There should be no obvious abnormalities such as bubbles, pin holes or cracks on the overcoat or outer termination.

There should be no obvious electrode material or other foreign matter on the overcoat.

There should be no obvious electrode material or other foreign matter on back surface of the substrate and on side surface of the longitudinal axis.

8 . MASS

The mass of the chip resistor is 0.8mg ± 0.5mg.

9 . Deciphering the manufacturing date from the Lot No.

An example of the Lot No. is shown below. Read the manufacturing date and take first-in first-out method.

Example :   11     36     XXXXXX  

Manufacturing year : Last two digits of the western calendar year. (2011)

Week of manufacture : Shows week 01 to 53 in a year. (36:8/28 to 9/3)

Shows line number, serial number or manufacturing plant Code.



1 0 . RECOMMENDABLE CONDITION OF SOLDERING

1 0 . 1 Reflow Soldering

Reflow soldering with lead free solder.

Condition of soldering : Preheat 150 ~ 180 less than 120s.  
: Reflow zone 220 less than 60s.  
Maximum temperature :  $260 \pm 5$  less than 10s.  
Time : Maximum of twice.

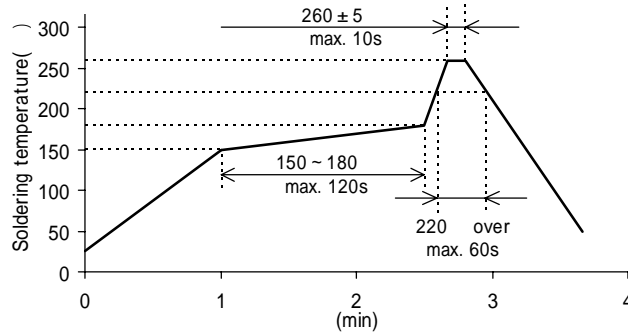

1 0 . 2 Reworking of soldering

Reworking of soldering shall be limited to one time.  
Temperature of soldering tip : 350 or less  
Working time : Not longer than 3s.  
Soldering iron : 20W or less.

1 1 . OTHERS

1 1 . 1 In regard to the Export Trade Control Decree.

Resistor That Rohm Co., Ltd . sells is not an object of controlled goods in Annex 1(Item 1 ~ 15) of Export Trade Control Order. But it is an object of controlled goods in Annex 1(Item 16) of Export Trade Control Order. In case of export, please confirm if it applies to "objective" criteria or an "informed"(by MITT clause) on the basis of "catch-all" controls for Non-Proliferation of Weapons of Mass Destruction.

1 1 . 2 On use of ozone layer destroying substances

No ozone layer destroying substances are used in our resistors.

1 1 . 3 On use of fluorocarbons

No specific fluorocarbons or alternative fluorocarbons are used in the manufacture of our resistors.

1 1 . 4 Regarding specific bromine type fire resistant materials

None of the following specific bromine type materials are used in our resistors.

P B B 0 s  
P B B s

1 1 . 5 Requests prior to changes

In the manufacture and utilization of the chip resistors there are conditions that develop which require materials or processes to be changed. In such cases, request will be made prior to change to obtain approval.

1 1 . 6 Manufacturing flow chart and basic design quality

As requested specially, the flow chart for the manufacturing processes of the chip resistor and the basic quality will be submitted separately.

Fig.3 : TEST BOARD A

(UNIT: mm)

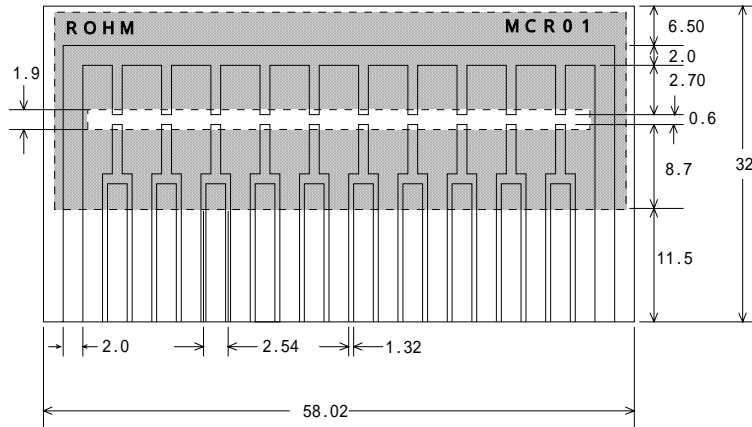

- NOTE) \*1 The shaded area shows the solder resist treatment.  
\*2 All surface, except terminals used for connectors, receive pre-flux treatment.

Fig.4 : TEST BOARD B

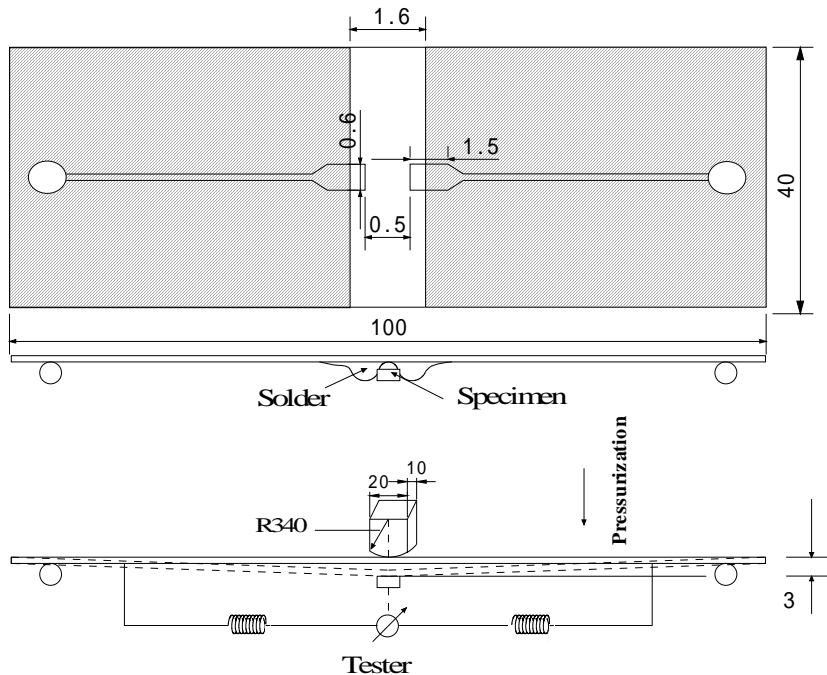

- NOTE) \*1 The shaded area shows the solder resist treatment.  
\*2 All surface, except terminals used for connectors, receive pre-flux treatment.  
\*3 During the test, the distance among support points shall be 90mm and the center of the chip resistor and the center between support points should be aligned to within  $\pm 2$ mm.

Laminate material: Glass fabric base epoxies.  
Compatible with JIS C 6484  
Thickness of board : 1.6mmt

Copper material: Copper purity is 99.5% or more.  
Compatible with JIS C 6484  
Copper foil thickness : 35 $\mu$ m

1. SCOPE

This specification covers the tape package requirements for chip resistor MCR01, to be used on automatic placement systems.

2. PACKAGING CODE

<u>MCR01</u>	<u>MRT</u>	<u>D</u>	_____
TYPE	PACKAGING CODE	F	_____
		J	_____
		RESISTANCE TOLERANCE	RESISTANCE VALUE (IEC CODE)

3. TAPE DIMENSION (UNIT: mm)

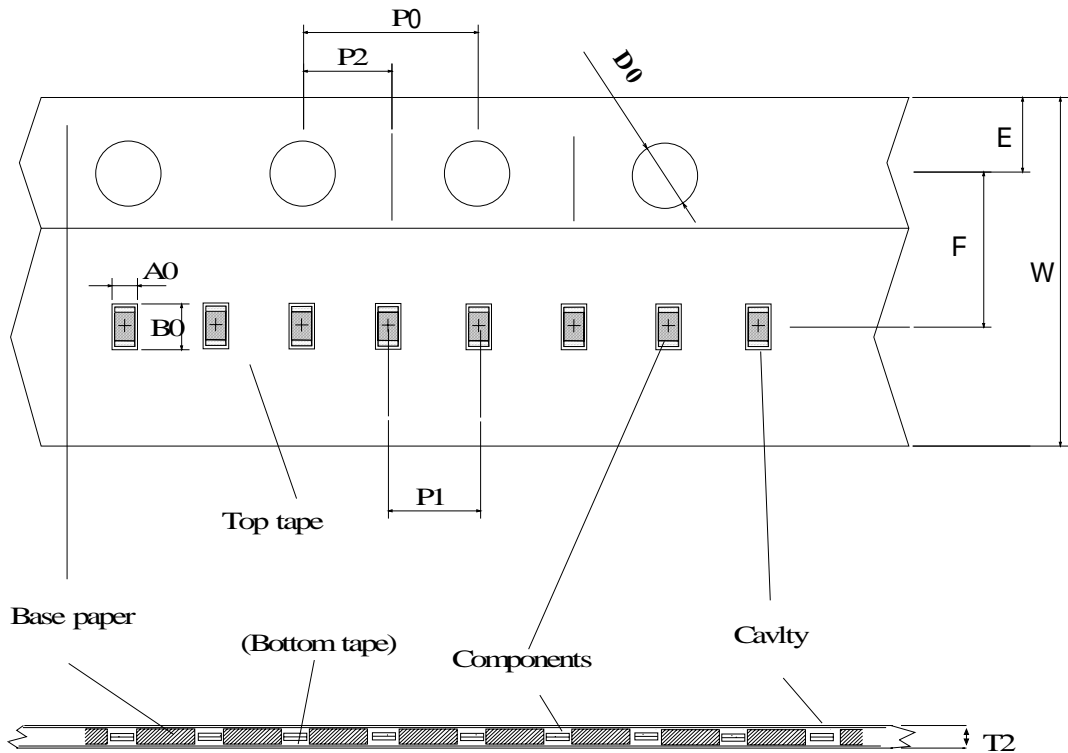

W	F	E	A0	B0
8.0 ± 0.3	3.5 ± 0.05	1.75 ± 0.1	0.7 ± 0.1	1.2 ± 0.1
D0	P0	P1	P2	T2
+0.1 1.5 0	4.0 ± 0.1	2.0 ± 0.1	2.0 ± 0.05	MAX.1.1

#### 4. MECHANICAL CHARACTERISTICS

##### 4.1 COVER TAPE PEELING STRENGTH

: 0.07N PEELING STRENGTH 0.50N

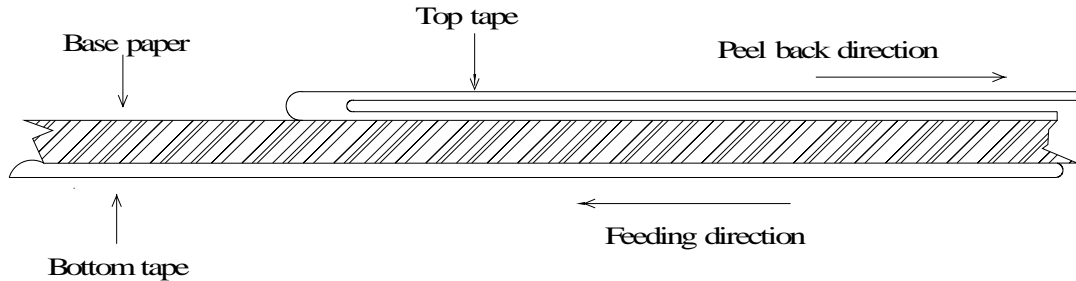

4.2 Base tape should not adhere to top tape when top tape is peeled back, and peel back direction is as follows.

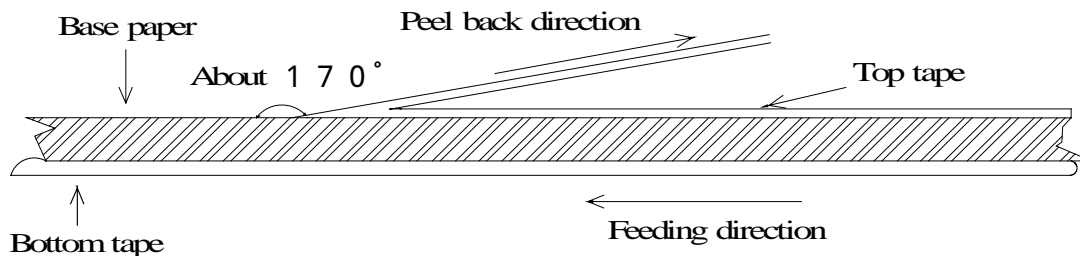

#### 5. TAPE PACKAGING

- 5.1 Components are set in tape cavities with the same side (resistive paste upside).
- 5.2 The accumulated pitch tolerance shall be within  $\pm 0.2\text{mm}$  at 10 pitches.
- 5.3 Tape bent resistance  
No damage on the tape and the cavity when tape is bent with the radius of 15mm.
- 5.4 Components in tape cavity shall not adhere to bottom / cover tape.
- 5.5 Components shall not be blocked by tape fragments or foreign materials when they are taken out from cavities.
- 5.6 The top tape shall not cover up the sprocket holes of tape.

**6. TAPE REEL**

6.1 Tape feeding direction shall be shown in the picture drawn below.

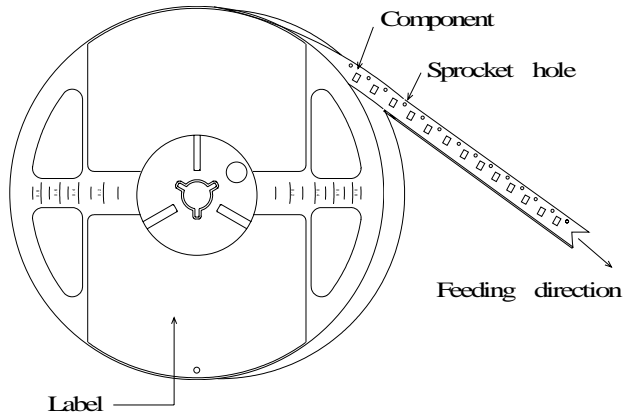

**6.2 Leader tape**

Leader tape is given a portion of only cover tape and of blank cavities. (no resistor.)

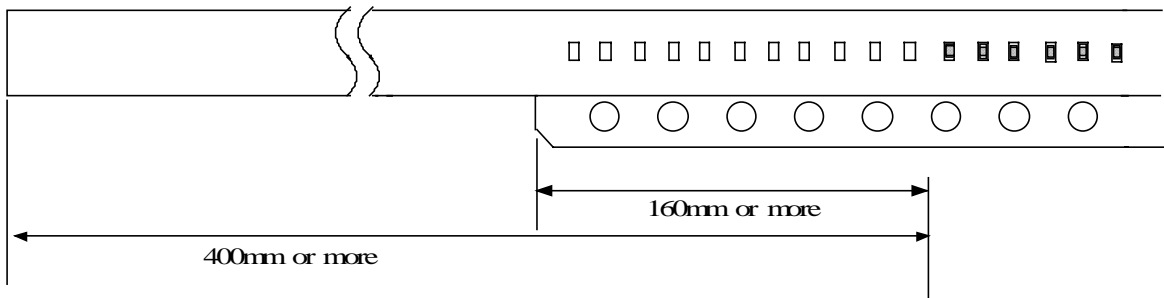

**6.3 Tail tape(trail tape)**

Trail tape is given a portion of blank cavities (no resistor).

And the trail tape should not be fixed by adhesive to reel and must be the one which can be pulled out easily from the reel.

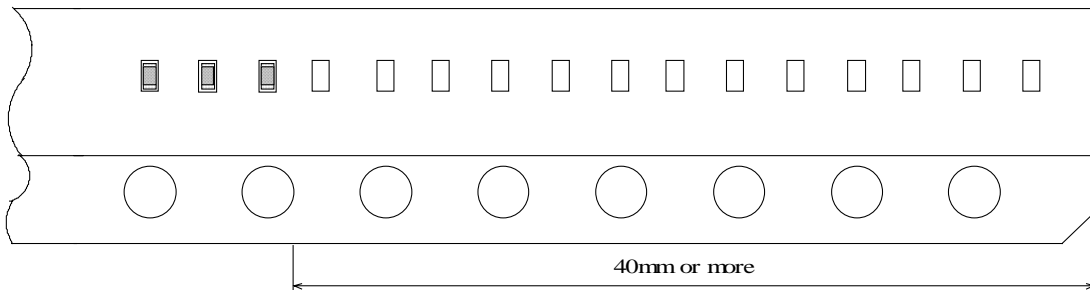

7. REEL DIMENSIONS (UNIT: mm)

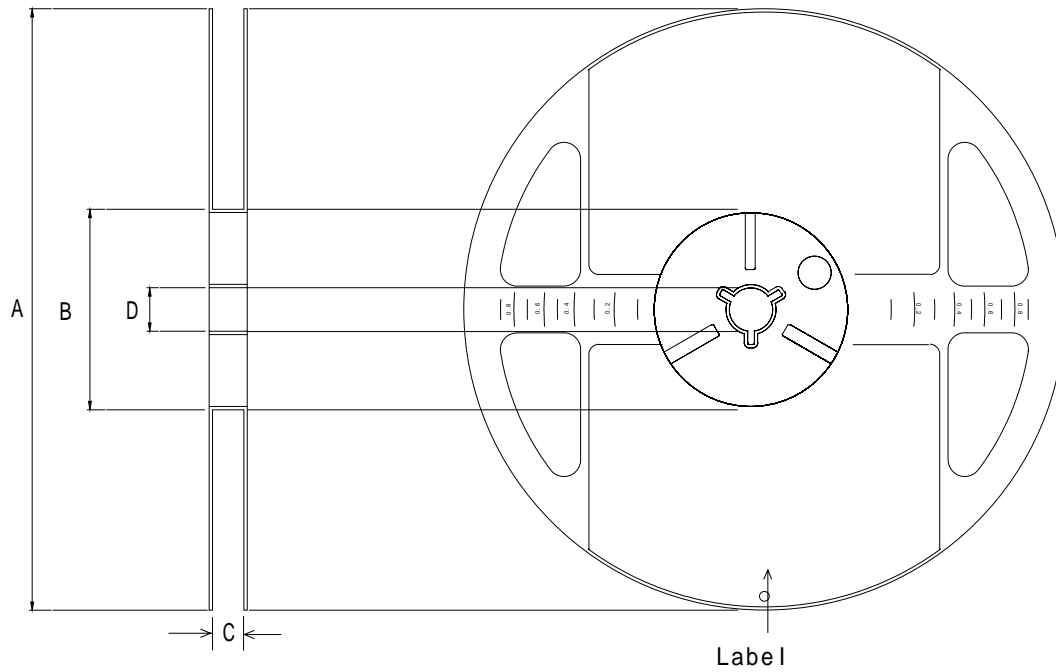

A	B	C	D
0	+1	+1.0	
180	60	9	13 ± 0.2
-1.5	0	0	

MATERIAL

REEL: POLYSTYRENE

PACKING

10,000pcs / Reel

## X-ON Electronics

Largest Supplier of Electrical and Electronic Components

*Click to view similar products for [Thick Film Resistors](#) category:*

*Click to view products by [ROHM](#) manufacturer:*

Other Similar products are found below :

[MCR03EZPFX3162](#) [MCR004YZPJ332](#) [201007J022KT4E](#) [201007F1653T4E](#) [201007F6652T4E](#) [0603WAF137KT5E](#) [RTT204702FTE](#)  
[RTT203000FTE](#) [RTT2056R0FTE](#) [CR2010F470KE04Z](#) [RTT018451FTH](#) [RTT021802DTH](#) [0402WGF510LTCE](#) [0201WMJ0200TEE](#)  
[TR0603B26K7P0550Z](#) [0201WMF5102TEE](#) [1210W2J047KT5E](#) [YLR12-2-4F-W](#) [HOT\(0.25x1.3\)-3.2-0R-I](#) [HOT\(0.4x1.5\)-5.2-0R-I](#)  
[HoT\(0.45x1.5\)-8.2-0R-I](#) [0201WMF1103TEE](#) [0201WMF7152TEE](#) [1210W2J0124T5E](#) [201007J010LT4E](#) [201007J0360T4E](#) [201007J0430T4E](#)  
[0805W8F931KT5E](#) [1206W4F5231T5E](#) [1210W2J0620T5E](#) [201007J0822T4E](#) [0201WMF1005TCE](#) [0201WMF1212TCE](#) [0201WMF1373TCE](#)  
[0201WMF1400TCE](#) [0201WMF2000TEE](#) [0201WMF2001TCE](#) [0201WMF226JTCE](#) [0201WMF2672TCE](#) [0201WMF2803TCE](#)  
[0201WMF357JTCE](#) [0201WMF3743TCE](#) [0201WMF430JTCE](#) [0201WMF4990TCE](#) [0201WMF5104TCE](#) [0201WMF510JTEE](#)  
[0201WMF5110TCE](#) [0201WMF6652TEE](#) [0201WMF6812TCE](#) [0201WMF8200TCE](#)