

●Features

- 1) Full line up from ultra small size (01005) to 2512 with jumper type.
- 2) ROHM resistors have obtained ISO9001/ISO/TS16949 certification.

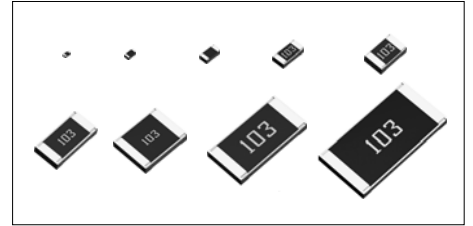

| Part No. | Size | | Type Code | Packing Specification | Quantity / Reel |
|---------------|------|--------|-----------|------------------------------|-----------------|
| | (mm) | (inch) | | | |
| MCR006 | 0603 | 0201 | YRT | Paper tape (2mm pitch) | 15,000 |
| MCR01 | 1005 | 0402 | MRT | | 10,000 |
| MCR03 | 1608 | 0603 | ERT | Paper tape (4mm pitch) | 5,000 |
| MCR10 | 2012 | 0805 | | | |
| MCR18 | 3216 | 1206 | | | |
| MCR25 | 3225 | 1210 | JRT | Embossed tape (4mm pitch) | 4,000 |
| MCR50 | 5025 | 2010 | | | |
| MCR100 | 6432 | 2512 | | | |

●Part Number Description

| M C R | 0 0 6 | Y R T | J | 1 0 0 | | | | | | |
|--------------------------------------|--|------------------|---|--|----------------------|-----------------|------------|------------|----------|------------|
| Part No. | Size (mm [inch]) | Type Code | Resistance Tolerance | Nominal Resistance | | | | | | |
| MCR (Micro chip resistors) | 006 (0603 [0201]) 01 (1005 [0402]) 03 (1608 [0603]) 10 (2012 [0805]) 18 (3216 [1206]) 25 (3225 [1210]) 50 (5025 [2010]) 100 (6432 [2512]) | | D (±0.5%) F (±1%) J (±5%) (Including jumper type) | Resistance code, 3 or 4 digits. 000 denotes jumper type. <table border="1" style="width: 100%; border-collapse: collapse;"> <tr> <th>Resistance tolerance</th> <th>Resistance code</th> </tr> <tr> <td>D,F</td> <td>: 4 digits</td> </tr> <tr> <td>J</td> <td>: 3 digits</td> </tr> </table> Ex.) 1Ω = 1R0 (±5%) 9.1Ω = 9R1 (±5%) 10Ω = 10R0 (±0.5%,±1%) 100 (±5%) 2.2MΩ = 2204 (±1%) 225 (±5%) | Resistance tolerance | Resistance code | D,F | : 4 digits | J | : 3 digits |
| Resistance tolerance | Resistance code | | | | | | | | | |
| D,F | : 4 digits | | | | | | | | | |
| J | : 3 digits | | | | | | | | | |

●Products List

| Part No. | Type Code | Rated Power (70°C) (W) | Limiting Element Voltage (V) | Temperature Coefficient (ppm / °C) | Resistance Tolerance (%) | Resistance Range | Series | Operating Temperature Range (°C) |
|---|-----------|------------------------------|------------------------------------|--|--------------------------------|--|---------|---|
| MCR006 | YRT | 0.05 | 25 | +600 / -200 ±250 | J(±5%) | 1.0Ω to 9.1Ω 10Ω to 10MΩ | E24 | -55 to +125 |
| | | | | ±250 | F(±1%) | 10Ω to 10MΩ | | |
| | | | | ±200 ±100 | D(±0.5%) | 10Ω to 910Ω 1kΩ to 1MΩ | | |
| Jumper type : Rmax = 50m Ω / Imax. = 0.5A | | | | | | | | |
| MCR01 | MRT | 0.063 | 50 | +500 / -250 ±200 | J(±5%) | 1.0Ω to 9.1Ω 10Ω to 10MΩ | E24 | |
| | | | | ±100 | F(±1%) | 10Ω to 976kΩ 10Ω to 2.2MΩ 1MΩ to 2.2MΩ | E24,E96 | |
| | | | | ±100 ±50 | D(±0.5%) | 10Ω to 91Ω 100Ω to 1MΩ | E24 | |
| Jumper type : Rmax = 50m Ω / Imax. = 1A | | | | | | | | |
| MCR03 | ERT | 0.1 | 50 | ±400 ±200 | J(±5%) | 1.0Ω to 9.1Ω 10Ω to 10MΩ | E24 | |
| | | | | ±100 | F(±1%) | 10Ω to 976kΩ 10Ω to 10MΩ 1MΩ to 10MΩ | E24,E96 | |
| | | | | ±100 ±50 | D(±0.5%) | 10Ω to 91Ω 100Ω to 1MΩ | E24 | |
| Jumper type : Rmax = 50m Ω / Imax. = 1A | | | | | | | | |
| MCR10 | ERT | 0.125 | 150 | ±400 ±200 | J(±5%) | 1.0Ω to 9.1Ω 10Ω to 10MΩ | E24 | |
| | | | | ±100 | F(±1%) | 10Ω to 976kΩ 10Ω to 2.2MΩ 1MΩ to 2.2MΩ | E24,E96 | |
| | | 0.1 | | ±100 ±50 | D(±0.5%) | 10Ω to 91Ω 100Ω to 1MΩ | E24 | |
| Jumper type : Rmax = 50m Ω / Imax. = 2A | | | | | | | | |
| MCR18 | ERT | 0.25 | 200 | ±400 ±200 | J(±5%) | 1.0Ω to 9.1Ω 10Ω to 10MΩ | E24 | |
| | | | | ±100 | F(±1%) | 10Ω to 976kΩ 10Ω to 2.2MΩ 1MΩ to 2.2MΩ | E24,E96 | |
| | | 0.125 | | ±100 ±50 | D(±0.5%) | 10Ω to 91Ω 100Ω to 1MΩ | E24 | |
| Jumper type : Rmax = 50m Ω / Imax. = 2A | | | | | | | | |
| MCR25 | JRT | 0.25 | 200 | ±200 ±100 | J(±5%) | 1.0Ω to 9.1Ω 10Ω to 3.3MΩ | E24 | |
| | | | | ±100 | F(±1%) | 10Ω to 1MΩ | E24,E96 | |
| | | | | Jumper type : Rmax = 50m Ω / Imax. = 2A | | | | |
| MCR50 | JRT | 0.5 | 200 | ±250 ±100 | J(±5%) | 1.0Ω to 9.1Ω 10Ω to 560kΩ | E24 | |
| | | | | ±100 | F(±1%) | 10Ω to 180kΩ | E24,E96 | |
| | | | | Jumper type : Rmax = 50m Ω / Imax. = 2A | | | | |
| MCR100 | JRT | 1 | 200 | ±250 ±100 | J(±5%) | 1.0Ω to 9.1Ω 10Ω to 100kΩ | E24 | -55 to +125 |
| | | | | ±100 | F(±1%) | 10Ω to 82kΩ | E24,E96 | |
| | | | | Jumper type : Rmax = 50m Ω / Imax. =2A | | | | |

*Design and specifications are subject to change without notice. Carefully check the specification sheet supplied with the product before using or ordering it.

*Rated voltage is determined from the following.

When rated voltage exceeds the limiting element voltage, the limiting element voltage shall be the rated voltage.

*Rated voltage = $\sqrt{\text{Rated power} \times \text{Resistance}}$

●Chip Resistor Dimensions and Markings

■ MCR006 / 01 / 03 ■ MCR10 / 18 / 25 / 50 / 100

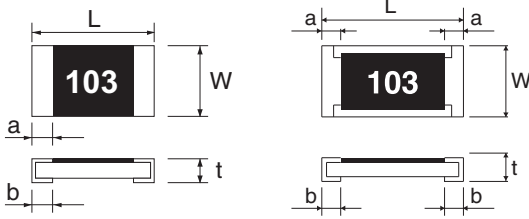

<Marking method>

There are three or four digits used for the calculation number according to IEC code and "R" is used for the decimal point.

(Unit : mm)

| Part No. | Type Code | (mm) | (inch) | L | W | t | a | b | Marking existence |
|----------|-----------|------|--------|-----------|-----------|-----------|-----------|---------------------------------------|-------------------|
| MCR006 | YRT | 0603 | 0201 | 0.6±0.03 | 0.3±0.03 | 0.23±0.03 | 0.15±0.05 | 0.15±0.05 | No |
| MCR01 | MRT | 1005 | 0402 | 1.0±0.05 | 0.5±0.05 | 0.35±0.05 | 0.2±0.1 | 0.25 ^{+0.05} _{-0.1} | No |
| MCR03 | ERT | 1608 | 0603 | 1.6±0.1 | 0.8±0.1 | 0.45±0.1 | 0.3±0.2 | 0.3±0.2 | Yes * |
| MCR10 | ERT | 2012 | 0805 | 2.0±0.1 | 1.25±0.1 | 0.5±0.1 | 0.35±0.2 | 0.35±0.2 | Yes |
| MCR18 | ERT | 3216 | 1206 | 3.05±0.15 | 1.55±0.15 | 0.55±0.1 | 0.45±0.25 | 0.35±0.25 | Yes |
| MCR25 | JRT | 3225 | 1210 | 3.2±0.15 | 2.5±0.15 | 0.55±0.15 | 0.5±0.25 | 0.5±0.25 | Yes |
| MCR50 | JRT | 5025 | 2010 | 5.0±0.15 | 2.5±0.15 | 0.55±0.15 | 0.6±0.25 | 0.6±0.25 | Yes |
| MCR100 | JRT | 6432 | 2512 | 6.3±0.15 | 3.2±0.15 | 0.55±0.15 | 0.6±0.25 | 0.6±0.25 | Yes |

Marking method of jumper type

| Jumper type | Marking existence |
|-----------------------------|-------------------|
| MCR006 / 01 / 25 / 50 / 100 | No |
| MCR03 / 10 / 18 | Yes |

*Marking method of MCR03

The description of markings on the chip resistor are as shown below.

① Marking method (J class):

The nominal resistance is expressed in by E-24series 3 digits. The first 2 digits apply to the resistance value and the last one indicates the number of zeros to follow. The R is used as a decimal point.

Example : 100kΩ = 104

② Marking method (F/D class):

·For the resistance value contained in E96 series.

The nominal resistance is expressed in 3 digits. The first 2 digits is symbol to the resistance value and the last one is symbol to multipliers.

Example : 100kΩ = 01d (01d→100 × 10³ = 100,000Ω = 100kΩ)

Example : 3.01kΩ = 47b (47b→301 × 10¹ = 3010Ω = 3.01kΩ)

·For the resistance value not contained in E96 series and contained in E-24 series.

The marking is expressed by E-24 series in 3 digits and one short bar under the last marking letter.

Example : 390Ω = 391

Symbol for E96 Series nominal resistance value

| Symbol | E96 | Symbol | E96 | Symbol | E96 | Symbol | E96 |
|--------|-----|--------|-----|--------|-----|--------|-----|
| 01 | 100 | 25 | 178 | 49 | 316 | 73 | 562 |
| 02 | 102 | 26 | 182 | 50 | 324 | 74 | 576 |
| 03 | 105 | 27 | 187 | 51 | 332 | 75 | 590 |
| 04 | 107 | 28 | 191 | 52 | 340 | 76 | 604 |
| 05 | 110 | 29 | 196 | 53 | 348 | 77 | 619 |
| 06 | 113 | 30 | 200 | 54 | 357 | 78 | 634 |
| 07 | 115 | 31 | 205 | 55 | 365 | 79 | 649 |
| 08 | 118 | 32 | 210 | 56 | 374 | 80 | 665 |
| 09 | 121 | 33 | 215 | 57 | 383 | 81 | 681 |
| 10 | 124 | 34 | 221 | 58 | 392 | 82 | 698 |
| 11 | 127 | 35 | 226 | 59 | 402 | 83 | 715 |
| 12 | 130 | 36 | 232 | 60 | 412 | 84 | 732 |
| 13 | 133 | 37 | 237 | 61 | 422 | 85 | 750 |
| 14 | 137 | 38 | 243 | 62 | 432 | 86 | 768 |
| 15 | 140 | 39 | 249 | 63 | 442 | 87 | 787 |
| 16 | 143 | 40 | 255 | 64 | 453 | 88 | 806 |
| 17 | 147 | 41 | 261 | 65 | 464 | 89 | 825 |
| 18 | 150 | 42 | 267 | 66 | 475 | 90 | 845 |
| 19 | 154 | 43 | 274 | 67 | 487 | 91 | 866 |
| 20 | 158 | 44 | 280 | 68 | 499 | 92 | 887 |
| 21 | 162 | 45 | 287 | 69 | 511 | 93 | 909 |
| 22 | 165 | 46 | 294 | 70 | 523 | 94 | 931 |
| 23 | 169 | 47 | 301 | 71 | 536 | 95 | 953 |
| 24 | 174 | 48 | 309 | 72 | 549 | 96 | 976 |

Symbol for multipliers

| Symbol | A | b | C | d | E | F | X | Y |
|-------------|-----------------|-----------------|-----------------|-----------------|-----------------|-----------------|------------------|------------------|
| multipliers | 10 ⁰ | 10 ¹ | 10 ² | 10 ³ | 10 ⁴ | 10 ⁵ | 10 ⁻¹ | 10 ⁻² |

●Land pattern Example

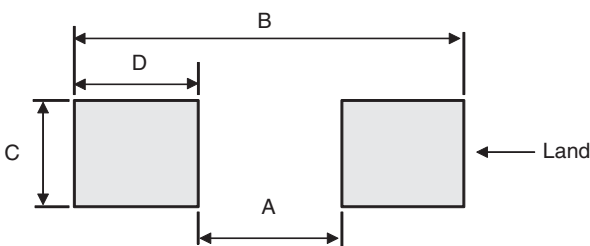

(Unit : mm)

| Part No. | Type Code | A | B | C | D |
|----------|-----------|-----|------|------|------|
| MCR006 | YRT | 0.3 | 0.84 | 0.3 | 0.27 |
| MCR01 | MRT | 0.5 | 1.3 | 0.5 | 0.4 |
| MCR03 | ERT | 1.0 | 2.0 | 0.8 | 0.5 |
| MCR10 | ERT | 1.2 | 2.6 | 1.15 | 0.7 |
| MCR18 | ERT | 2.2 | 4.0 | 1.5 | 0.9 |
| MCR25 | JRT | 2.2 | 4.0 | 2.3 | 0.9 |
| MCR50 | JRT | 3.8 | 6.0 | 2.3 | 1.1 |
| MCR100 | JRT | 5.1 | 8.1 | 3.0 | 1.5 |

●Derating Curve

When the ambient temperature exceeds 70°C, power dissipation must be adjusted according to the derating curves below.

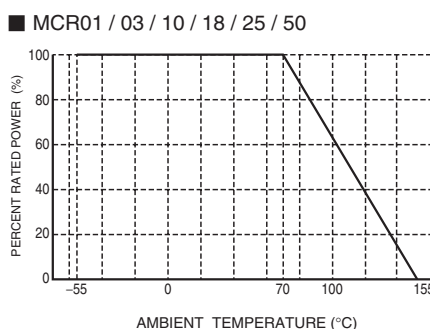
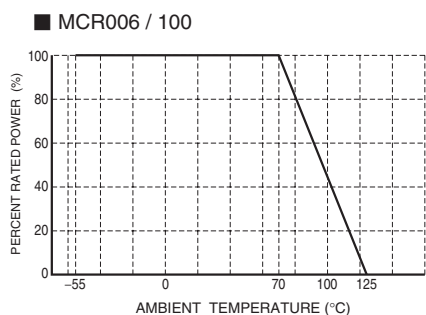

●Characteristics

| Test Items | Guaranteed Value | | Test Conditions |
|--|--|-------------|---|
| | Resistor Type | Jumper Type | |
| Resistance | See "Products List" | | 20°C |
| Variation of resistance with temperature | See "Products List" | | Measurement : +20 / -55 / +20 / +125°C |
| Overload | ± (2.0%+0.1Ω) | Max. 50mΩ | Test voltage is the smaller one of ① or ② ① Rated voltage (current) ×2.5, 2s. ② Maximum overload voltage |
| Solderability | A new uniform coating of minimum of 95% of the surface being immersed and no soldering damage. | | Rosin-Ethanol : 25% (Weight) Soldering condition : 235±5°C Duration of immersion : 2.0±0.5s |
| Resistance to soldering heat | ± (1.0%+0.05Ω) No remarkable abnormality on the appearance. | Max. 50mΩ | Soldering condition : 260±5°C Duration of immersion : 10±1s |
| Rapid change of temperature | ± (1.0%+0.05Ω) | Max. 50mΩ | Test temp. -55°C to +125°C 100cycle (MCR006) -55°C to +125°C 300cycle (MCR01) -55°C to +125°C 5cycle (MCR03 / 10 / 18 / 25 / 50 / 100) |
| Damp heat, steady state | ± (3.0%+0.1Ω) | Max. 100mΩ | 40°C, 93%RH (Relative Humidity) Test time : 1,000h to 1,048h |
| Endurance at 70°C | ± (3.0%+0.1Ω) | Max. 100mΩ | 70°C Rated voltage (current) 1.5h : ON – 0.5h : OFF Test time : 1,000h to 1,048h |
| Endurance | ± (3.0%+0.1Ω) | Max. 100mΩ | 125°C (MCR006 / 25 / 50 / 100) 155°C (MCR01 / 03 / 10 / 18) Test time : 1,000h to 1,048h |
| Resistance to solvent | ± (1.0%+0.05Ω) | Max. 50mΩ | 23±5°C, Immersion cleaning, 5±0.5min Solvent : 2-propanol |
| Bend strength of the end face plating | ± (1.0%+0.05Ω) Without mechanical damage such as breaks. | Max. 50mΩ | - |

Maximum overload voltage *Test voltage

| MCR006 | MCR01 | MCR03 | MCR10 | MCR18 | MCR025 | MCR50 | MCR100 |
|--------|-------|-------|-------|-------|--------|-------|--------|
| 50V | 100V | 100V | 200V | 400V | 400V | 400V | 400V |

Compliance Standard(s) : IEC60115-8
JISC 5201-8

●Tape Dimensions

(Unit : mm)

■ Paper Tape

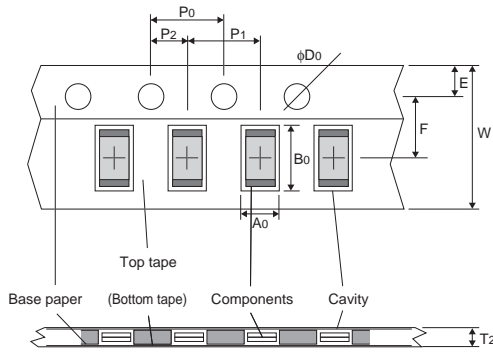

| Part No. | Type Code | W | F | E | A0 | B0 |
|----------|-----------|---------|----------|----------|-----------|-----------|
| MCR006 | YRT | 8.0±0.2 | 3.5±0.05 | 1.75±0.1 | 0.38±0.03 | 0.68±0.03 |
| MCR01 | MRT | 8.0±0.3 | 3.5±0.05 | 1.75±0.1 | 0.7±0.1 | 1.2±0.1 |
| MCR03 | ERT | 8.0±0.3 | 3.5±0.05 | 1.75±0.1 | 1.0±0.1 | 1.8±0.1 |
| MCR10 | ERT | 8.0±0.3 | 3.5±0.05 | 1.75±0.1 | 1.55±0.1 | 2.3±0.1 |
| MCR18 | ERT | 8.0±0.3 | 3.5±0.05 | 1.75±0.1 | 1.9±0.2 | 3.5±0.2 |
| MCR25 | JRT | 8.0±0.2 | 3.5±0.05 | 1.75±0.1 | 2.8±0.2 | 3.5±0.2 |

| Part No. | Type Code | D0 | P0 | P1 | P2 | T2 |
|----------|-----------|--|----------|----------|----------|---------|
| MCR006 | YRT | $\phi 1.5 \begin{smallmatrix} +0.1 \\ 0 \end{smallmatrix}$ | 4.0±0.1 | 2.0±0.05 | 2.0±0.05 | Max 0.5 |
| MCR01 | MRT | $\phi 1.5 \begin{smallmatrix} +0.1 \\ 0 \end{smallmatrix}$ | 4.0±0.1 | 2.0±0.1 | 2.0±0.05 | Max 1.1 |
| MCR03 | ERT | $\phi 1.5 \begin{smallmatrix} +0.1 \\ 0 \end{smallmatrix}$ | 4.0±0.1 | 4.0±0.1 | 2.0±0.05 | Max 1.1 |
| MCR10 | ERT | $\phi 1.5 \begin{smallmatrix} +0.1 \\ 0 \end{smallmatrix}$ | 4.0±0.1 | 4.0±0.1 | 2.0±0.05 | Max 1.1 |
| MCR18 | ERT | $\phi 1.5 \begin{smallmatrix} +0.1 \\ 0 \end{smallmatrix}$ | 4.0±0.1 | 4.0±0.1 | 2.0±0.05 | Max 1.1 |
| MCR25 | JRT | $\phi 1.5 \begin{smallmatrix} +0.1 \\ 0 \end{smallmatrix}$ | 4.0±0.05 | 4.0±0.1 | 2.0±0.05 | Max 1.1 |

■ Embossed Tape
<MCR25 / 50 / 100>

(Unit : mm)

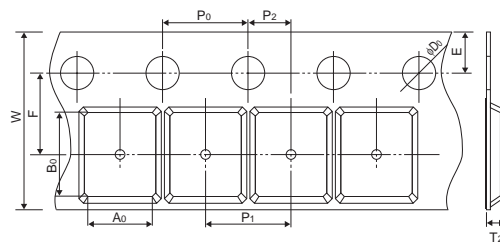

| Part No. | Type Code | W | F | E | A0 | B0 |
|----------|-----------|---------|----------|----------|---------|---------|
| MCR25 | JRT | 8.0±0.3 | 3.5±0.05 | 1.75±0.1 | 3.0±0.1 | 3.5±0.1 |
| MCR50 | JRT | 12±0.3 | 5.5±0.05 | 1.75±0.1 | 3.4±0.2 | 5.6±0.2 |
| MCR100 | JRT | 12±0.3 | 5.5±0.05 | 1.75±0.1 | 3.5±0.2 | 6.7±0.2 |

| Part No. | Type Code | D0 | P0 | P1 | P2 | T2 |
|----------|-----------|--|---------|---------|----------|---------|
| MCR25 | JRT | $\phi 1.5 \begin{smallmatrix} +0.1 \\ 0 \end{smallmatrix}$ | 4.0±0.1 | 4.0±0.1 | 2.0±0.05 | Max 1.1 |
| MCR50 | JRT | $\phi 1.5 \begin{smallmatrix} +0.1 \\ 0 \end{smallmatrix}$ | 4.0±0.1 | 4.0±0.1 | 2.0±0.05 | Max 1.1 |
| MCR100 | JRT | $\phi 1.5 \begin{smallmatrix} +0.1 \\ 0 \end{smallmatrix}$ | 4.0±0.1 | 4.0±0.1 | 2.0±0.05 | Max 1.1 |

●Reel Dimensions

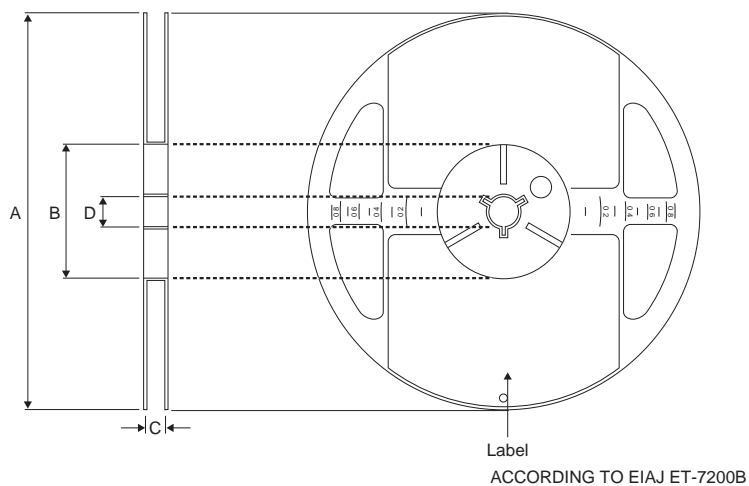

(Unit : mm)

| Part No. | Type Code | A | B | C | D |
|----------|-----------|--|---|--|-------------------|
| MCR006 | YRT | $\phi 180 \begin{matrix} 0 \\ -1.5 \end{matrix}$ | $\phi 60 \begin{matrix} +1.0 \\ 0 \end{matrix}$ | $9 \begin{matrix} +1.0 \\ 0 \end{matrix}$ | $\phi 13 \pm 0.2$ |
| MCR01 | MRT | | | | |
| MCR03 | ERT | | | | |
| MCR10 | ERT | | | | |
| MCR18 | ERT | | | $13 \begin{matrix} +1.0 \\ 0 \end{matrix}$ | |
| MCR25 | JRT | | | | |
| MCR50 | JRT | | | | |
| MCR100 | JRT | | | | |

Notes

- 1) The information contained herein is subject to change without notice.
- 2) Before you use our Products, please contact our sales representative and verify the latest specifications :
- 3) Although ROHM is continuously working to improve product reliability and quality, semiconductors can break down and malfunction due to various factors.
Therefore, in order to prevent personal injury or fire arising from failure, please take safety measures such as complying with the derating characteristics, implementing redundant and fire prevention designs, and utilizing backups and fail-safe procedures. ROHM shall have no responsibility for any damages arising out of the use of our Products beyond the rating specified by ROHM.
- 4) Examples of application circuits, circuit constants and any other information contained herein are provided only to illustrate the standard usage and operations of the Products. The peripheral conditions must be taken into account when designing circuits for mass production.
- 5) The technical information specified herein is intended only to show the typical functions of and examples of application circuits for the Products. ROHM does not grant you, explicitly or implicitly, any license to use or exercise intellectual property or other rights held by ROHM or any other parties. ROHM shall have no responsibility whatsoever for any dispute arising out of the use of such technical information.
- 6) The Products are intended for use in general electronic equipment (i.e. AV/OA devices, communication, consumer systems, gaming/entertainment sets) as well as the applications indicated in this document.
- 7) The Products specified in this document are not designed to be radiation tolerant.
- 8) For use of our Products in applications requiring a high degree of reliability (as exemplified below), please contact and consult with a ROHM representative : transportation equipment (i.e. cars, ships, trains), primary communication equipment, traffic lights, fire/crime prevention, safety equipment, medical systems, servers, solar cells, and power transmission systems.
- 9) Do not use our Products in applications requiring extremely high reliability, such as aerospace equipment, nuclear power control systems, and submarine repeaters.
- 10) ROHM shall have no responsibility for any damages or injury arising from non-compliance with the recommended usage conditions and specifications contained herein.
- 11) ROHM has used reasonable care to ensure the accuracy of the information contained in this document. However, ROHM does not warrants that such information is error-free, and ROHM shall have no responsibility for any damages arising from any inaccuracy or misprint of such information.
- 12) Please use the Products in accordance with any applicable environmental laws and regulations, such as the RoHS Directive. For more details, including RoHS compatibility, please contact a ROHM sales office. ROHM shall have no responsibility for any damages or losses resulting non-compliance with any applicable laws or regulations.
- 13) When providing our Products and technologies contained in this document to other countries, you must abide by the procedures and provisions stipulated in all applicable export laws and regulations, including without limitation the US Export Administration Regulations and the Foreign Exchange and Foreign Trade Act.
- 14) This document, in part or in whole, may not be reprinted or reproduced without prior consent of ROHM.



Thank you for your accessing to ROHM product informations.
More detail product informations and catalogs are available, please contact us.

ROHM Customer Support System

<http://www.rohm.com/contact/>

X-ON Electronics

Largest Supplier of Electrical and Electronic Components

Click to view similar products for [Thick Film Resistors - SMD category](#):

Click to view products by [ROHM manufacturer](#):

Other Similar products are found below :

[CR-05FL7--150R](#) [CR-05FL7--19K6](#) [CR-05FL7--243R](#) [CR-05FL7--40K2](#) [CR-05FL7--698K](#) [CR-12FP4--324R](#) [CR-12JP4--680R](#)
[M55342K06B1E78RS3](#) [M55342K06B6E19RWL](#) [M55342K06B6E81RS3](#) [M55342M05B200DRWB](#) [M55342M06B4K70MS3](#) [MC0603-511-](#)
[JTW](#) [742C083750JTR](#) [MCR01MZPF1202](#) [MCR01MZPF1601](#) [MCR01MZPF1800](#) [MCR01MZPF6201](#) [MCR01MZPF9102](#) [MCR01MZPJ113](#)
[MCR01MZPJ121](#) [MCR01MZPJ125](#) [MCR01MZPJ751](#) [MCR03EZHJ103](#) [MCR03EZPFX2004](#) [MCR03EZPJ270](#) [MCR03EZPJ821](#)
[MCR10EZPF1102](#) [MCR18EZPJ330](#) [RC0603F1473CS](#) [RC0603F150CS](#) [RC1005F1152CS](#) [RC1005F1182CS](#) [RC1005F1372CS](#)
[RC1005F183CS](#) [RC1005F1911CS](#) [RC1005F1912CS](#) [RC1005F203CS](#) [RC1005F2052CS](#) [RC1005F241CS](#) [RC1005F2431CS](#)
[RC1005F3011CS](#) [RC1005F303CS](#) [RC1005F4321CS](#) [RC1005F4642CS](#) [RC1005F471CS](#) [RC1005F4751CS](#) [RC1005F5621CS](#)
[RC1005F6041CS](#) [RC1005J106CS](#)