

Dear customer

LAPIS Semiconductor Co., Ltd. ("LAPIS Semiconductor"), on the 1st day of October, 2020, implemented the incorporation-type company split (shinsetsu-bunkatsu) in which LAPIS established a new company, LAPIS Technology Co., Ltd. ("LAPIS Technology") and LAPIS Technology succeeded LAPIS Semiconductor's LSI business.

Therefore, all references to "LAPIS Semiconductor Co., Ltd.", "LAPIS Semiconductor" and/or "LAPIS" in this document shall be replaced with "LAPIS Technology Co., Ltd."

Furthermore, there are no changes to the documents relating to our products other than the company name, the company trademark, logo, etc.

Thank you for your understanding.

LAPIS Technology Co., Ltd.
October 1, 2020

ML62Q1700 Group

16-bit micro controller

GENERAL DESCRIPTION

ML62Q1700 Group is a high performance CMOS 16-bit microcontroller equipped with an 16-bit CPU nX-U16/100 and integrated with program memory(Flash memory), data memory(RAM), data Flash and rich peripheral functions such as the multiplier/divider, CRC generator, DMA controller, Clock generator, Simplified RTC, Timer, General Purpose Ports, UART, Synchronous serial port, I²C bus interface unit(Master,Slave), Buzzer, Voltage Level Supervisor(VLS), Successive approximation type A/D converter, D/A converter, Analog comparator, LCD driver, Safety function(IEC60730/60335 Class B) and so on.

The CPU nX-U16/100 is capable of efficient instruction execution in 1-instruction 1-clock mode by pipeline architecture parallel processing.

The built-in on-chip debug function enables debugging and programming the software. Also, ISP(In-System Programming) function supports the Flash programming in production line.

The ML62Q1700 Group has seven packages (48pin - 100pin) and ten kinds of memory sizes(32Kbyte - 512Kbyte).

Table 1 ML62Q1700 Group Product List

Program memory	Data memory (RAM)	Data Flash	48pin TQFP48	52pin TQFP52	64pin QFP64 TQFP64	80pin QFP80	100pin QFP100 TQFP100
512Kbyte	32Kbyte	8Kbyte	—	—	ML62Q1729	ML62Q1739	ML62Q1749
384Kbyte			—	—	ML62Q1728	ML62Q1738	ML62Q1748
256Kbyte	16Kbyte	4Kbyte	—	—	ML62Q1727	ML62Q1737	ML62Q1747
192Kbyte			—	—	ML62Q1726	ML62Q1736	ML62Q1746
160Kbyte			—	—	ML62Q1725	ML62Q1735	ML62Q1745
128Kbyte	16Kbyte		—	—	—	ML62Q1734	ML62Q1744
	8Kbyte		ML62Q1704	ML62Q1714	ML62Q1724	—	—
96Kbyte	16Kbyte		—	—	—	ML62Q1733	ML62Q1743
	8Kbyte		ML62Q1703	ML62Q1713	ML62Q1723	—	—
64Kbyte	8Kbyte		ML62Q1702	ML62Q1712	ML62Q1722	—	—
48Kbyte			ML62Q1701	ML62Q1711	ML62Q1721	—	—
32Kbyte			ML62Q1700	ML62Q1710	ML62Q1720	—	—
		—	—	—	—	—	

FEATURES

- CPU
 - 16-bit RISC CPU: nX-U16/100(A35 core)
 - Instruction system: 16-bit length instructions
 - Instruction set: Transfer, arithmetic operations, comparison, logic operations, multiplication/division, bit manipulations, bit logic operations, jump, conditional jump, call return stack manipulations, arithmetic shift, and so on
 - Built-in On-chip debug function
 - Built-in ISP (In-System Programming) function
 - Minimum instruction execution time
Approximately 30.5 μs (at 32.768 kHz system clock)
Approximately 62.5ns/41.6ns (at 16 MHz/24MHz system clock)

- Coprocessor for multiplication and division
 - Multiplication : 16bit × 16bit (operation time : 4 cycles)
 - Division : 32bit ÷ 16bit (operation time : 8 cycles)
 - Division : 32bit ÷ 32bit (operation time : 16 cycles)
 - Multiply-accumulate (non-saturating): 16bit × 16bit + 32bit (operation time : 4 cycles)
 - Multiply-accumulate (saturating): 16bit × 16bit + 32bit (operation time : 4 cycles)
 - Signed or Unsigned is selectable
- Operating voltage and temperature
 - Operating voltage: VDD = 1.6 to 5.5 V (V_{DD} should be 1.8V or over at Power-on)
 - Operating temperature: -40 °C to +105 °C
- Internal memory
 - Program memory area
 - Rewrite count: 100 cycles
 - Write unit: 32bit(4byte)
 - Erase unit: 16Kbyte/1Kbyte
 - Erase/Write temperature: 0 °C to +40 °C
 - Data Flash memory area
 - Rewrite count 10,000 cycles
 - Write unit: 8bit(1byte)
 - Erase unit: all area/128byte
 - Erase/Write temperature: -40 °C to +85 °C
 - Back Ground Operation(CPU can work while erasing and rewriting)

This product uses Super Flash® technology licensed from Silicon Storage Technology, Inc.
Super Flash® is a registered trademark of Silicon Storage Technology, Inc.
 - Data RAM area
 - Rewrite unit: 8bit/16bit (1byte/2byte)
 - Parity check function is available (interrupt / reset are generatable at Parity error)
- Clock generation circuit
 - Low-speed clock (LSCLK)
 - Internal low-speed RC oscillation: Approximately 32.768 kHz
 - External low-speed clock input: Approximately 32.768 kHz
 - External low-speed crystal oscillation: 32.768 kHz crystal resonator is connectable
 - 3 selectable crystal oscillation mode (Tough, Normal, and Low current consumption)
 - Tough mode: Largest oscillation allowance to make highest resistance against leakage between the pins
 - Normal mode: Normal oscillation allowance and current consumption
 - Low current consumption mode: Smallest oscillation allowance to make lower current consumption
 - High-speed clock (HSCLK)
 - PLL oscillation: 2 selectable oscillation frequency (24MHz and 16MHz) by code option
 - Watch Dog Timer (WDT): built-in independent clock for WDT (RC1K: Approximately 1kHz)
- Reset
 - Reset by reset input pin
 - Reset by Power-On Reset
 - Reset by WDT overflow
 - Reset by WDT invalid clear
 - Reset by RAM parity error
 - Reset by unused ROM area access (instruction access)
 - Reset by voltage level supervisor (VLS)
 - Software reset by BRK instruction (reset CPU only)
 - Reset the peripherals individually
 - Collective reset to the all control pins and peripheral circuits

- Power management
 - HALT mode: CPU stops executing instruction, peripheral circuits continue working
 - HALT-H mode: CPU stops executing instruction, high-speed clock oscillation stops and peripheral circuits continue working with low-speed clock
 - STOP mode: CPU and peripheral circuits stops executing instruction, both high-speed oscillation and low-speed oscillation stop.
 - STOP-D mode: CPU and peripheral circuits stops executing instruction, both high-speed oscillation and low-speed oscillation stop. The internal logic voltage (V_{DDL}) goes down to reduce the current consumption (RAM data is retained).
 - Clock gear: High-speed system clock frequency can be changed (1/1, 1/2, 1/4, 1/8, 1/16 or 1/32 of HSCLK)
 - Block Control Function: Powers down the unused function blocks (reset the block or stop supplying the clock)
- Interrupt controller
 - External interrupt ports : max. 12
 - Non-maskable interrupt source: 1 (Internal sources: WDT)
 - Maskable interrupt sources: max. 51
 - Four step interrupt levels
- Watchdog timer(WDT)
 - Selectable Operating clock : select RC1K or LSCLK by code option
 - Overflow period: 8selectable (7.8ms, 15.6ms, 31.3ms, 62.5ms, 125ms, 500ms, 2s and 8s)
 - Selectable window function (enable or disable): configurable clear enable period (50% or 75% of overflow period)
 - Selectable WDT operation : select Enable or Disable by code option
 - Readable WDT counter : WDT counter monitor function
- DMA(Direct Memory Access) controller
 - Channel: 2channel
 - Transfer unit: 8bit/16bit
 - Transfer count: 1 to 1024
 - Transfer cycle: 2 cycle transfer
 - Transfer address: Fixed addressing mode, increment addressing mode , and decrement addressing mode
 - Transfer target: Special Function Register (SFR)/RAM → SFR/RAM (Transfer from/to Flash is not supported)
 - Transfer request: External pins, Serial communication unit, Successive approximation type A/D converter, 16bit timer, and Functional timer
- Low-speed Time base counter
 - Generate 8 frequency (128Hz to 1Hz) internal pulse signals by dividing the Low-speed clock (LSCLK)
 - Selectable 3 interrupts from eight frequency internal pulse signals
 - 1Hz or 2Hz output from general purpose port
 - Built-in Frequency adjust function: Adjust range: Approximately -488ppm to +488ppm, adjust resolution: Approximately 0.119ppm
- Simplified RTC
 - Channel: 1channel
 - Count by a unit for one second from "00 min. 00 sec" to "59 min. 59 sec"
 - Selectable Periodical interrupt request from four periods (0.5s, 1s, 30s or 60s)
 - Built-in minute and second writing error protraction function

- Functional timer
 - Channel: Max. 8channel
 - Built-in timer, capture, and PWM function by 16 bit counter
 - One shot mode is available
 - Two types of PWM output with the same period and different duties, and complementary PWM output with the dead time
 - Monitor input signal duty and the period by capture function
 - Generate periodical interrupts, duty interrupts, and interrupts coincided with set value
 - Counter Start, Stop, Counter clear triggered by an external inputs or Timer
 - Generate Emergency stop and emergency stop interrupt triggered by an external input
 - Same start/stop among different channels of the functional timer
 - Selectable counter clock(external clock or divided by 1 to 128 of LSCLK or HSCLK) for each channels

- 16-bit General timers
 - Channel: Max. 8channel
 - 8 bits timer mode and 16-bit timer mode
 - Same start/stop among different channels of 16bit (8bit) timer
 - Timer output (toggled by overflow)
 - Selectable counter clock (external clock or divided by 1 to 128 of LSCLK or HSCLK) for each channels

- Serial communication unit
 - Synchronous Serial Port (SSIO) mode or UART mode is selectable
 - Channel: Max. 6channel

 - < Synchronous Serial Port mode>
 - Selectable from Master and Slave
 - Selectable from LSB first or MSB first
 - Selectable 8-bit length or 16-bit length

 - < UART mode>
 - Full-duplex communication mode and half-duplex communication mode
 - 5 to 8 bit length, parity or no parity, odd parity or even parity, 1 stop bit or 2 stop bits
 - Selectable from Positive logic or Negative logic
 - Selectable from LSB first or MSB first
 - Configurable wide range communication speed
 - 32.768kHz operation clock : 1 bit/s to 4,800 bit/s
 - 24MHz operation clock : 600 bit/s to 3M bit/s
 - 16MHz operation clock : 300 bit/s to 2M bit/s
 - Built-in baud rate generator

- I²C bus unit (Master / Slave)
 - Selectable from Master mode or Slave mode
 - Channel: 1channel

 - < Master function >
 - Standard mode (100 kbit/s), fast mode (400 kbit/s) and 1Mbps mode(1Mbit/s)
 - Handshake (Clock synchronization)
 - 7bit address format (10bit address format is supported)

 - < Slave function >
 - Standard mode (100 kbit/s), fast mode (400 kbit/s) and 1Mbps mode(1Mbit/s)
 - Clock stretch function
 - 7bit address format

- I²C bus Master
 - Channel: 2channel
 - Standard mode (100 kbit/s), fast mode (400 kbit/s) and 1Mbps mode(1Mbit/s)
 - Handshake (Clock synchronization)
 - 7bit address format (10bit address format is supported)

- General-purpose ports (GPIO)
 - I/O port: Max. 87 (Including one pin for on-chip debug and pins for other shared functions)
 - Input port: Max. 2(Including a shared function)
 - External interrupt port : Max. 12
 - LED driver port : Max. 86
 - Carrier frequency output function (for IR communication)
- Successive approximation type A/D converter (SA-ADC)
 - Channel: Max.16channel
 - Resolution: 10bit
 - Conversion time: Min. 2.25 μ s / channel (When the conversion clock is 8MHz)
 - Reference voltages are selectable
(V_{DD} pin / Internal reference voltage(V_{REFI} = Approximately 1.55V) / External reference voltage (V_{REF} pin))
 - Selected channel repeat conversion
 - dedicated result register for each channel
 - Interrupt determining by upper limit or lower limit threshold of conversion result
- Voltage Level Supervisor (VLS)
 - Accuracy: $\pm 4\%$
 - Threshold voltage: 12 selectable (from 1.85V to 4.00V)
 - Functional Voltage level detection reset (VLS reset)
 - Functional Voltage level detection interrupt (VLS0 interrupt)
- Analog comparator
 - Channel: 2channel
 - Selectable interrupt from the comparator output (rising edge or falling edge)
 - Selectable from sampling or without sampling
 - Comparable with external 2 inputs
 - Comparable with external input and internal reference voltage (0.8V)
- D/A converter
 - Channel: Max 2channel
 - Resolution: 8bit
 - Output impedance: 6k ohm (Typ.)
 - R-2R ladder type
- Buzzer
 - 4 buzzer mode (Continuous sound, Single sound, Intermittent sound 1 and Intermittent sound 2)
 - 8frequencies (4.096kHz to 293Hz)
 - 15 step duty (1/16 to 15/16)
 - Selectable from positive logic buzzer output or negative logic buzzer output
- CRC(Cyclic Redundancy Check) generator
 - Generation equation: $X^{16}+X^{12}+X^5+1$
 - Selectable from LSB first or MSB first
 - Built-in Automatic program memory CRC calculation mode in HALT mode
- LCD driver
 - Max. 480 dots (60seg x 8 com)^{*1}

ML62Q1700/1701/1702/1703/1704:	24seg \times 8com (com Max.), 29seg \times 3com (seg Max.)
ML62Q1710/1711/1712/1713/1714:	27seg \times 8com (com Max.), 32seg \times 3com (seg Max.)
ML62Q1720/1721/1722/1723/1724/ 1725/1726/1727/1728/1729:	35seg \times 8com (com Max.), 40seg \times 3com (seg Max.)
ML62Q1733/1734/1735/1736/1737/1738/1739:	45seg \times 8com (com Max.), 50seg \times 3com (seg Max.)
ML62Q1743/1744/1745/1746/1747/1748/1749:	60seg \times 8com (com Max.), 65seg \times 3com (seg Max.)
 - ^{*1} : Five pins are shared for common or segment, selectable by setting a SFR
 - 1/3 bias (built-in bias generation circuit)
 - Frame frequency (Approximately. 32Hz, 38Hz, 64Hz, 75Hz, 128Hz and 150Hz)

- Four bias generation modes (Internal voltage boost, External capacitive voltage divide, Internal capacitive voltage divide and External supply voltages)
- Contrast adjustment (32 steps) is available in the Internal voltage boost mode.
- Safety Function (IEC60730/60335 Class B)
 - Automatic switching to the internal low-speed RC oscillation in case the low-speed crystal oscillation stopped
 - RAM/SFR guard
 - Automatic program memory CRC calculation
 - RAM parity error detection
 - ROM unused area access reset (instruction access)
 - Clock mutual monitoring
 - WDT counter monitoring
 - SA-ADC test
 - UART test
 - Synchronous serial I/O test
 - I²C bus test
 - GPIO test
- Shipping package
 - 48-pin plastic TQFP
ML62Q1700/1701/1702/1703/1704 - xxxTB
(Blank part: :ML62Q1700/1701/1702/1703/1704-NNNTB)
 - 52-pin plastic TQFP
ML62Q1710/1711/1712/1713/1714 - xxxTB
(Blank part: ML62Q1710/1711/1712/1713/1714-NNNTB)
 - 64-pin plastic TQFP
ML62Q1720/1721/1722/1723/1724/1725/1726/1727/1728/1729 - xxxTB
(Blank part: ML62Q1720/1721/1722/1723/1724/1725/1726/1727/1728/1729-NNNTB)
 - 64-pin plastic QFP
ML62Q1720/1721/1722/1723/1724/1725/1726/1727/1728/1729 - xxxGA
(Blank part: ML62Q1720/1721/1722/1723/1724/1725/1726/1727/1728/1729-NNNGA)
 - 80-pin plastic QFP
ML62Q1733/1734/1735/1736/1737/1738/1739- xxxGA
(Blank part: ML62Q1733/1734/1735/1736/1737/1738/1739-NNNGA)
 - 100-pin plastic TQFP
ML62Q1743/1744/1745/1746/1747/1748/1749 – xxxTB
(Blank part: ML62Q1743/1744/1745/1746/1747/1748/1749-NNNTB)
 - 100-pin plastic QFP
ML62Q1743/1744/1745/1746/1747/1748/1749 - xxxGA
(Blank part: ML62Q1743/1744/1745/1746/1747/1748/1749-NNNGA)

xxx: ROM code number

ML62Q1700 Group how to read the part number

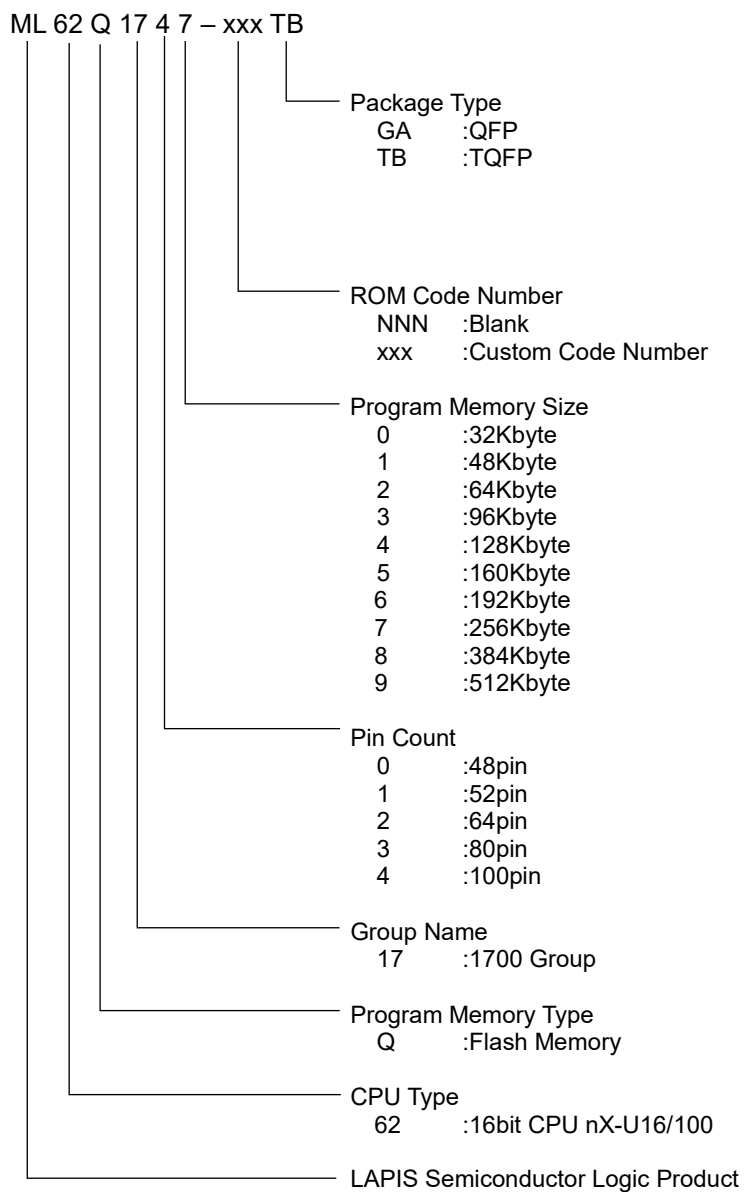

Figure 1 ML62Q1700 Group Part Number

ML62Q1700 Group Main Function List

Table 2 ML62Q1700 Group Main Function List

Part number	Pin				LCD drive pin		Interrupt	Timer		Serial	Analog												
	Total pin-counts	Power pin counts	Reset Input pin	Input port * ³	I/O port	LED drive port	LCD common/segment shared pin * ^{4,5}	LCD common pin * ⁵	LCD segment pin * ⁵	LCD bias pin	Internal Interrupt [source]	External Interrupt [port]	Functional Timer [ch]	16-bit Timer [ch] * ¹	Simplified RTC [ch]	Serial communication unit (Full-duplex UART or Synchronous serial) [ch] * ²	I ² C bus unit (Master/Slave) [ch]	I ² C bus interface (Master only) [ch]	10bit Successive type A/D converter [ch]	Analog comparator [ch]	Analog comparator [input pin]	8bit D/A converter [ch]	
ML62Q1700	48	3			37	36			24						2								1
ML62Q1701																							
ML62Q1702																							
ML62Q1703																							
ML62Q1704	52				41	40			27														
ML62Q1710																							
ML62Q1711																							
ML62Q1712																							
ML62Q1713	64				53	52			35						1	1	2						
ML62Q1714																							
ML62Q1720																							
ML62Q1721																							
ML62Q1722	1	2			5	3			5														
ML62Q1723																							
ML62Q1724																							
ML62Q1725																							
ML62Q1726	80				67	66			45						6								
ML62Q1727																							
ML62Q1728																							
ML62Q1729																							
ML62Q1733	45									43	12	8	8		6								2
ML62Q1734																							
ML62Q1735																							
ML62Q1736																							
ML62Q1737	100				87	86			60														
ML62Q1738																							
ML62Q1739																							
ML62Q1743																							
ML62Q1744																							
ML62Q1745																							
ML62Q1746																							
ML62Q1747																							
ML62Q1748																							
ML62Q1749																							

*¹ : One 16bit timer is configurable as two 8bit timers

*² : Synchronous Communication unit includes UART mode and Synchronous Serial Port mode. UART mode and Synchronous Serial Port can not be used at the same time in the same channel.

*³ : Shared with pins for crystal oscillation

*⁴ : The LCD common/segment shared pins are shared for common or segment, selectable by setting a SFR

*⁵ : All LCD drive pins are shared with general purpose I/O ports.

BLOCK DIAGRAM

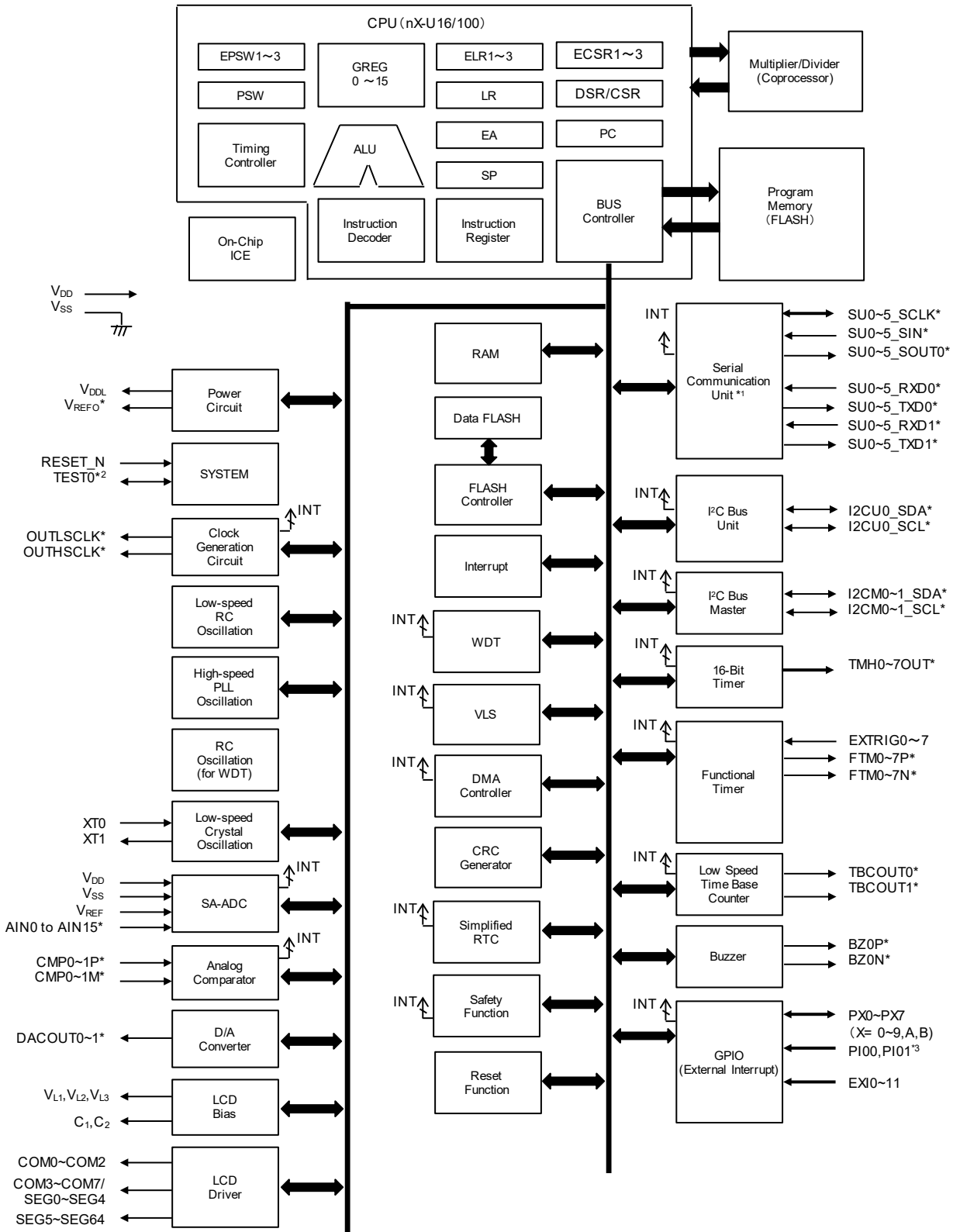

- * : Indicates the shared function of general ports.
- *1 : Shared UART and Synchronous Serial Port.
- *2 : Not available as the input port when connecting to the on-chip debug emulator.
- *3 : Not available as the input port when connecting to the crystal resonator.

Figure 2 ML62Q1700 Group Block Diagram

PIN CONFIGURATION

The pin names in the pin-layout indicate 1st-function or LCD function. Refer to Table-3 or Table-4 about other functions.

Pin Layout of 48pin TQFP Package

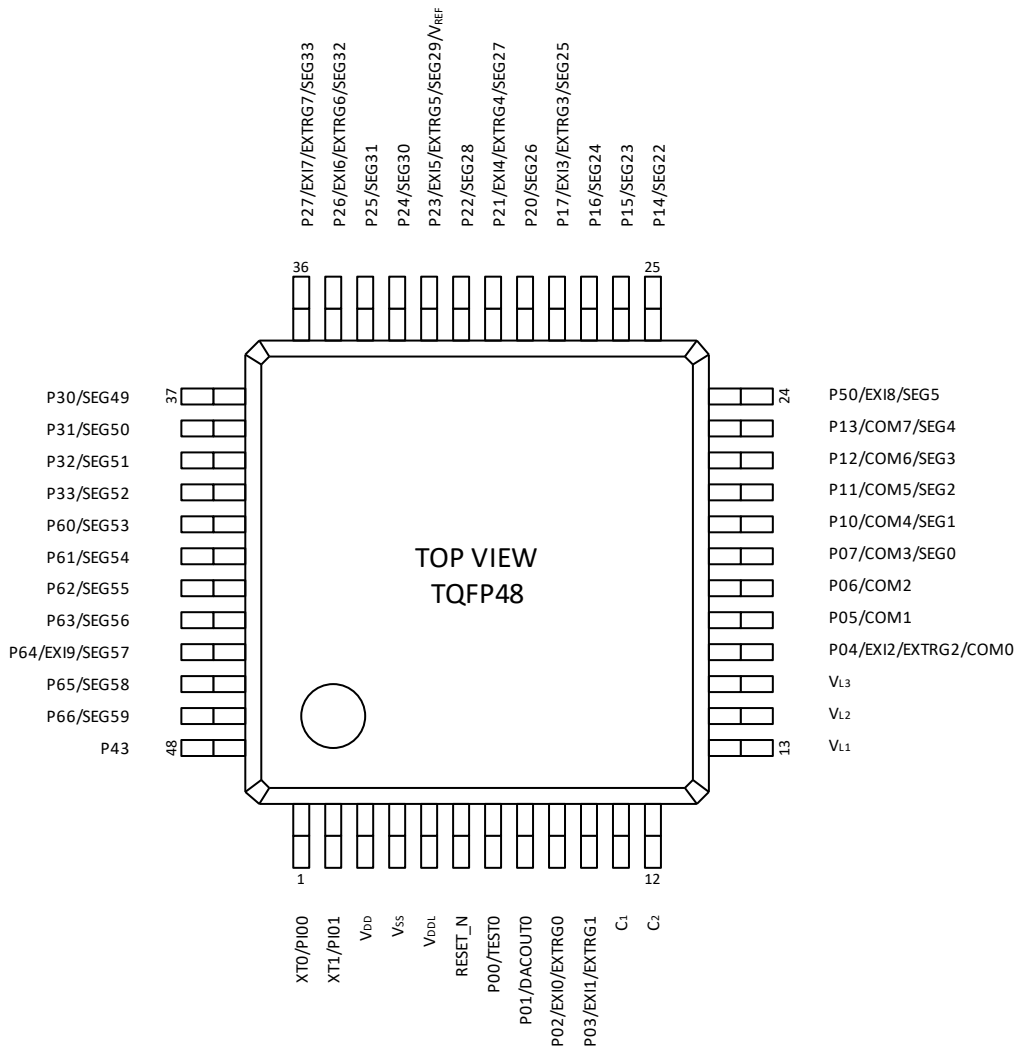

Figure 3 Pin Layout of 48pin TQFP Package

Pin Layout of 52pin TQFP Package

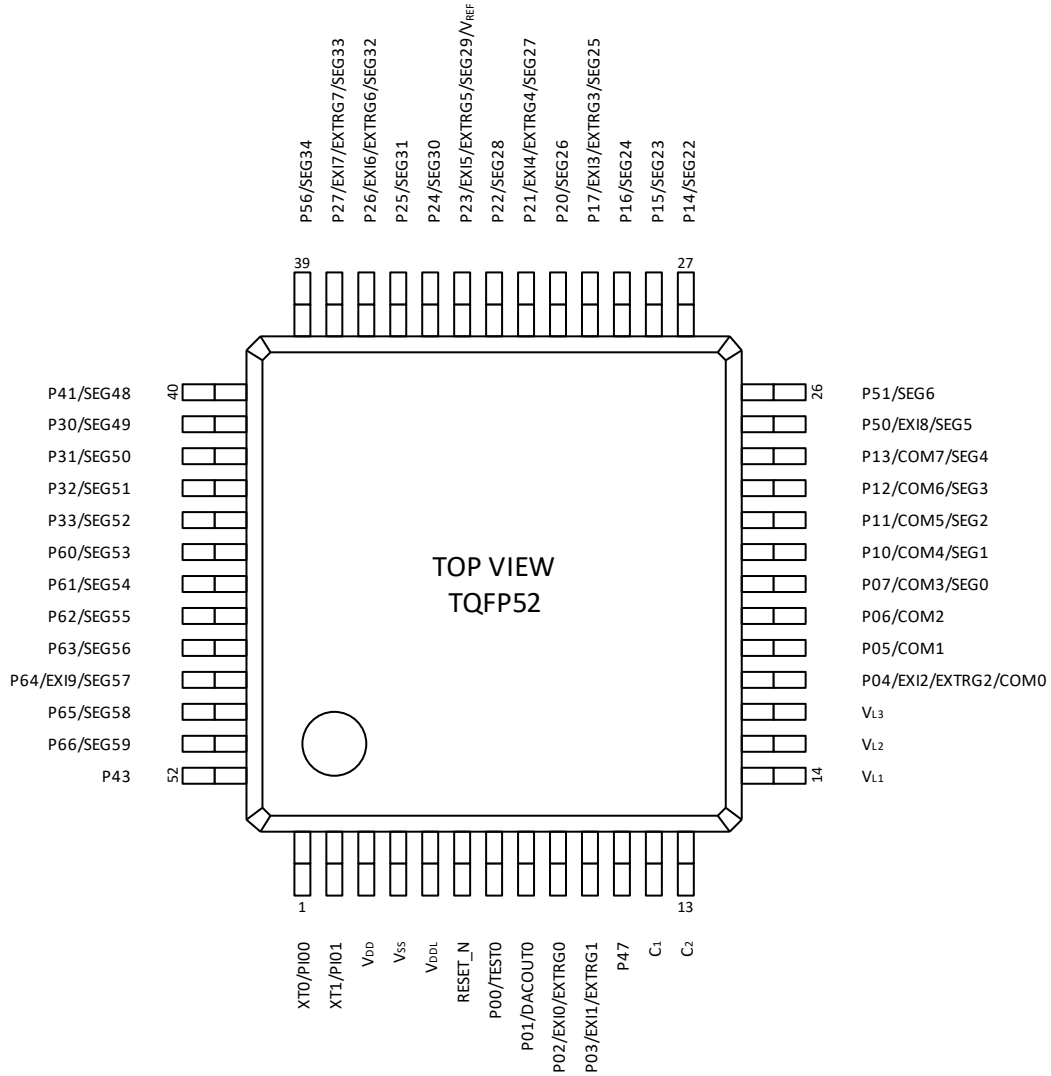

Figure 4 Pin Layout of 52pin TQFP52 Package

Pin Layout of 64pin TQFP/QFP Package

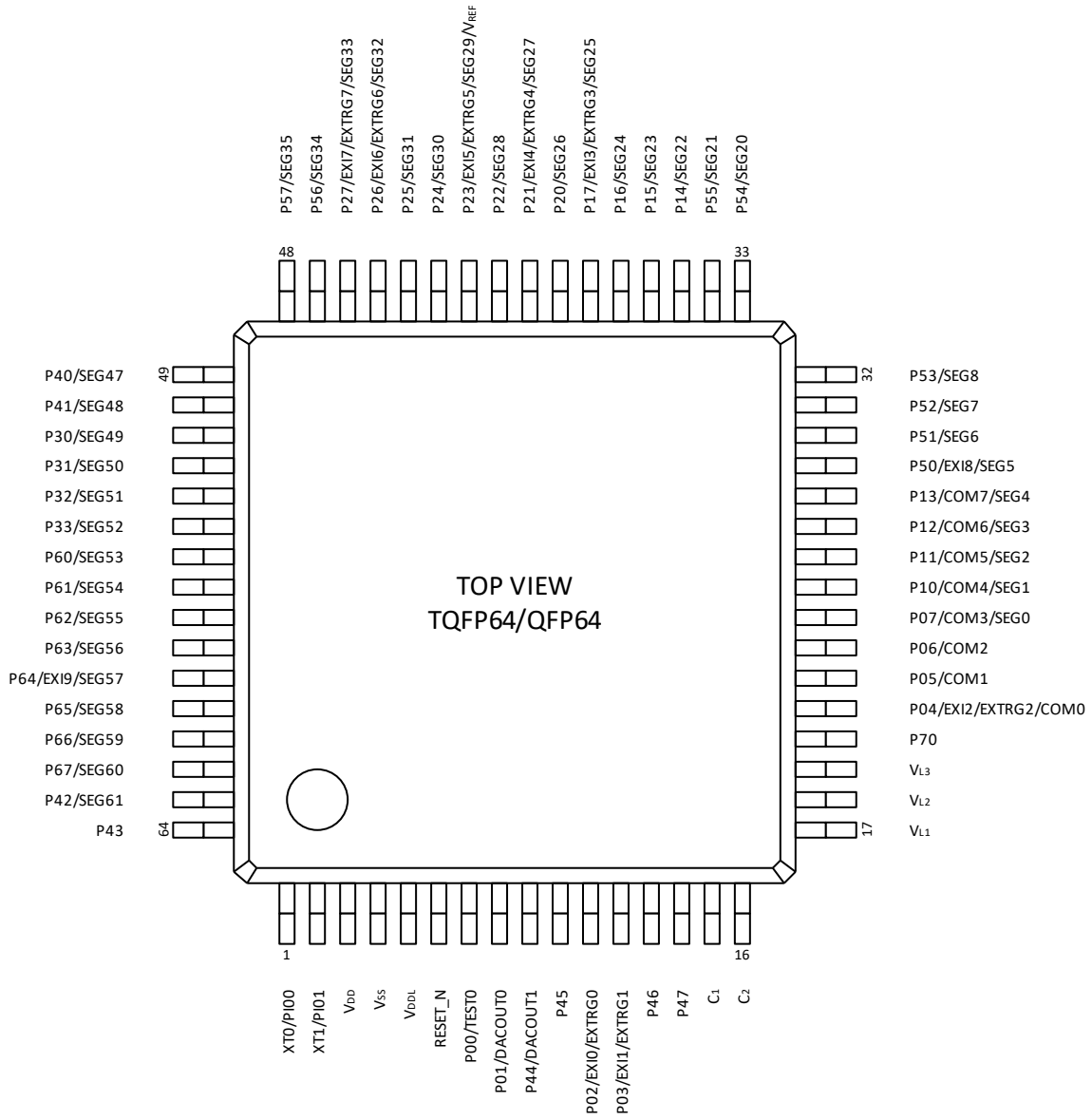

Figure 5 Pin Layout of 64pin TQFP/QFP Package

Pin Layout of 80pin QFP Package

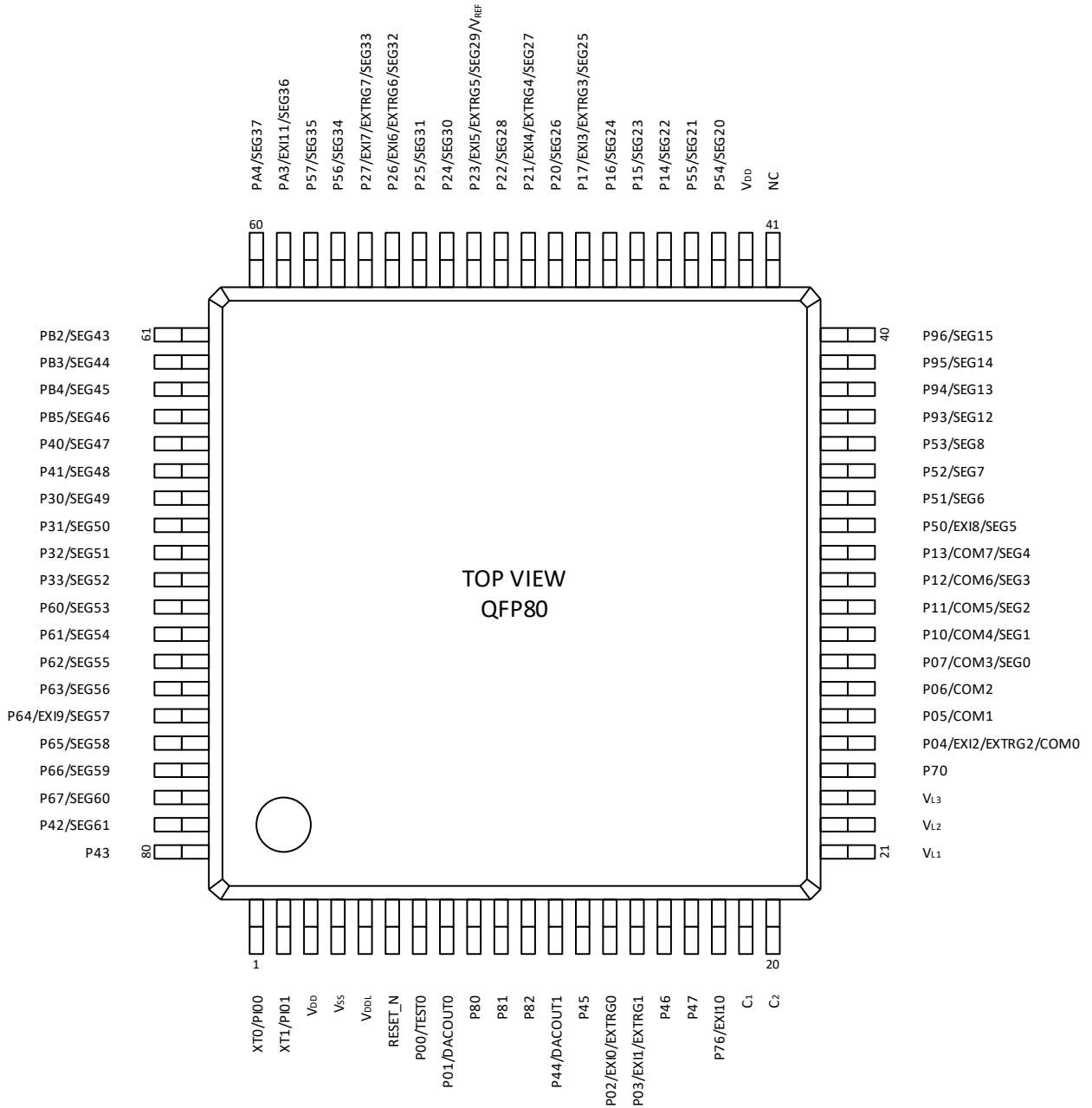

Figure 6 Pin Layout of 80pin QFP Package

Pin Layout of 100pin TQFP Package

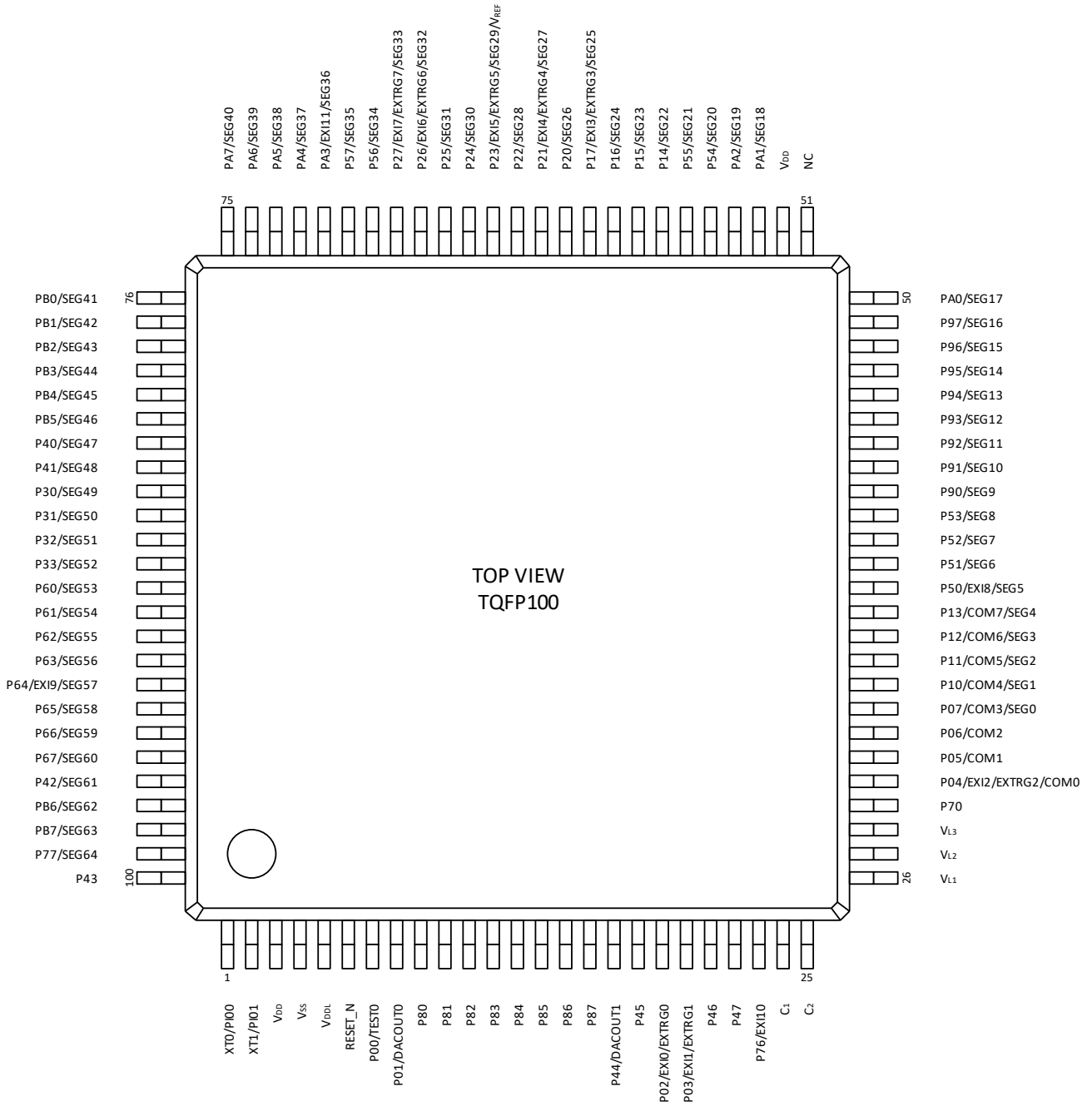

Figure 7 Pin Layout of 100pin TQFP Package

Pin Layout of 100pin QFP Package

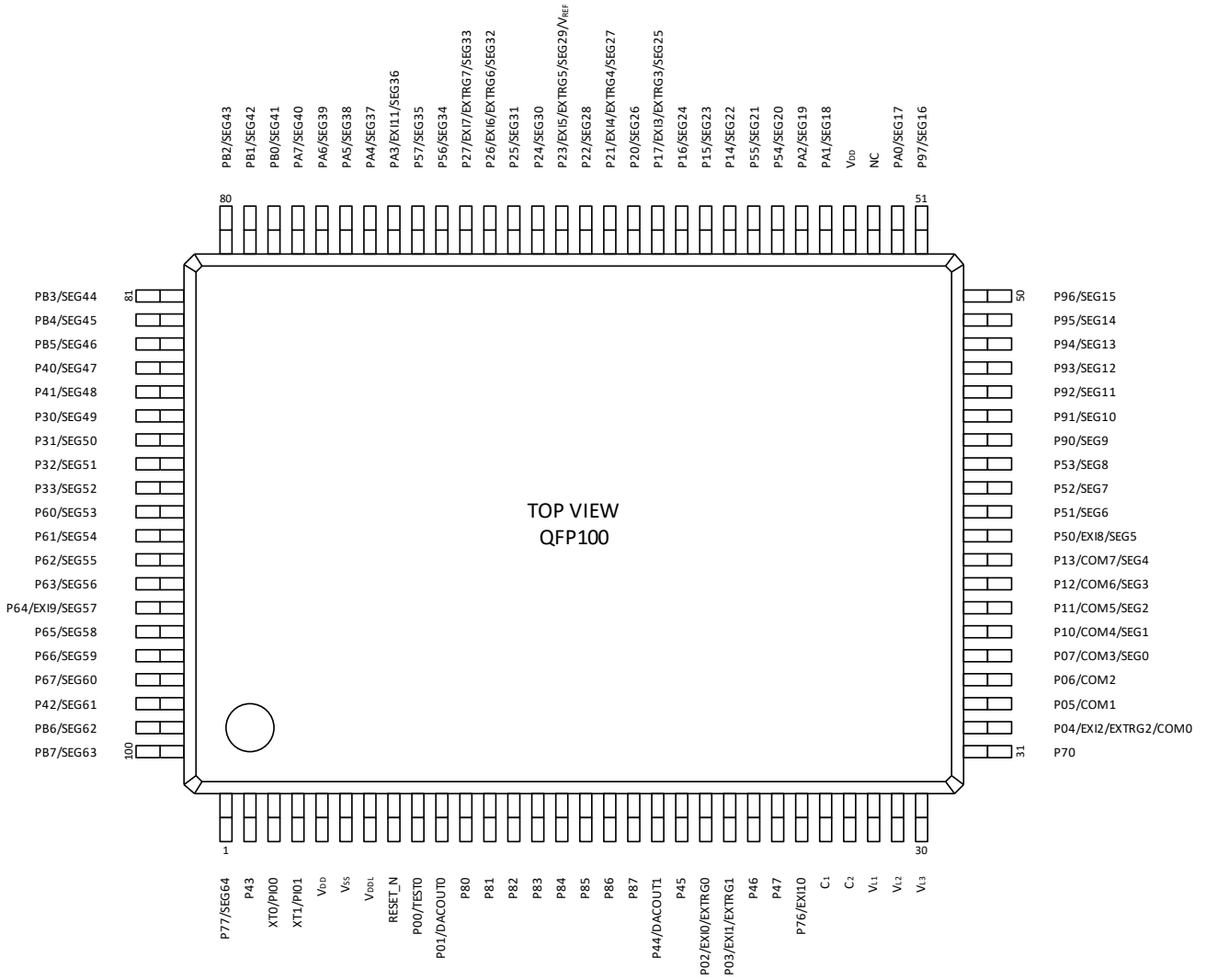

Figure 8 Pin Layout of 100pin QFP Package

PIN LIST

Table 3 Pin List (1/3)

Pin No.						Pin name (1 st func)	1 st func. others	2 nd func. SIU	3 rd func. SIU	4 th func. I2C	5 th func. Timer	6 th func. others	7 th func. others	8 th func. ADC
48 Pin	52 Pin	64 Pin	80 pin	TOFP100	QFP100									
3	3	3	3	3	5	V _{DD}	-	-	-	-	-	-	-	-
-	-	-	42	52	54	V _{DD}	-	-	-	-	-	-	-	-
4	4	4	4	4	6	V _{SS}	-	-	-	-	-	-	-	-
-	-	-	41	51	53	NC	-	-	-	-	-	-	-	-
5	5	5	5	5	7	V _{DDL}	-	-	-	-	-	-	-	-
1	1	1	1	1	3	XT0	PI00	-	-	-	-	-	-	-
2	2	2	2	2	4	XT1	PI01	-	-	-	-	-	-	-
6	6	6	6	6	8	RESET_N	RESET_N	-	-	-	-	-	-	-
7	7	7	7	7	9	P00	TEST0	-	-	-	-	-	-	-
8	8	8	8	8	10	P01	DACOUT0	-	-	-	FTM3P *1	TBCOUT0	TBCOUT1	-
9	9	11	14	19	21	P02	EXI0 EXTRG0	SU0_RXD0 SU0_SIN	-	I2CU0_SCL *1	FTM0P	OUTLSCLK	CMP0M	-
10	10	12	15	20	22	P03	EXI1 EXTRG1	SU0_TXD0 SU0_SOUT	SU0_TXD1	I2CU0_SDA	FTM0N	OUTHSCCLK	CMP0P	AIN11
16	17	21	25	30	32	P04	EXI2 EXTRG2 COM0	SU0_SCLK	-	I2CU0_SCL	TMH0OUT	-	-	-
17	18	22	26	31	33	P05	COM1	-	-	-	-	-	-	-
18	19	23	27	32	34	P06	COM2	-	-	I2CM0_SDA	-	-	-	-
19	20	24	28	33	35	P07	COM3 SEG0	SU0_RXD1	SU0_RXD0	I2CM0_SCL	-	-	-	-
20	21	25	29	34	36	P10	COM4 SEG1	SU0_TXD1	-	-	-	-	-	-
21	22	26	30	35	37	P11	COM5 SEG2	SU0_SCLK	-	-	-	-	-	-
22	23	27	31	36	38	P12	COM6 SEG3	SU0_RXD0 SU0_SIN	-	-	TMH4OUT	-	-	-
23	24	28	32	37	39	P13	COM7 SEG4	SU0_TXD0 SU0_SOUT	SU0_TXD1	-	TMH1OUT	-	TMH3OUT	-
25	27	35	45	57	59	P14	SEG22	-	-	-	-	-	-	-
26	28	36	46	58	60	P15	SEG23	-	-	I2CU0_SDA	-	-	-	-
27	29	37	47	59	61	P16	SEG24	SU1_SCLK	-	I2CU0_SCL	TMH5OUT	-	-	-
28	30	38	48	60	62	P17	EXI3 EXTRG3 SEG25	SU0_RXD1	SU0_RXD0	-	FTM1P	TBCOUT0	BZ0P	AIN0
29	31	39	49	61	63	P20	SEG26	SU0_TXD1	-	-	FTM1N	TBCOUT1	BZ0N	AIN1
30	32	40	50	62	64	P21	EXI4 EXTRG4 SEG27	SU1_RXD0 SU1_SIN	-	-	FTM2P	OUTLSCLK	-	AIN2
31	33	41	51	63	65	P22	SEG28	SU1_TXD0 SU1_SOUT	SU1_TXD1	I2CM0_SDA	FTM2N	OUTHSCCLK	-	AIN3
32	34	42	52	64	66	P23	EXI5 EXTRG5 SEG29 V _{REF}	SU1_SCLK	-	I2CM0_SCL	TMH2OUT	-	-	V _{REF0}
33	35	43	53	65	67	P24	SEG30	SU1_RXD0 SU1_SIN	-	-	-	-	-	AIN4
34	36	44	54	66	68	P25	SEG31	SU1_TXD0 SU1_SOUT	SU1_TXD1	-	-	-	-	AIN5
35	37	45	55	67	69	P26	EXI6 EXTRG6 SEG32	SU1_RXD1	SU1_RXD0	I2CU0_SDA	FTM3P	TBCOUT0	BZ0P	AIN6
36	38	46	56	68	70	P27	EXI7 EXTRG7 SEG33	SU1_TXD1	-	I2CU0_SCL	FTM3N	TBCOUT1	BZ0N	AIN7

*1: No assignment to ML62Q1500 Series.

Table 3 Pin List (2/3)

Pin No.						Pin name (1 st func.)	1 st func. others	2 nd func. SIU *3	3 rd func. SIU *3	4 th func. I2C	5 th func. Timer *3	6 th func. others	7 th func. others	8 th func. ADC *3
48 Pin	52 Pin	64 Pin	80 pin	TOFP100	QFP100									
37	41	51	67	84	86	P30	SEG49	-	-	-	-	-	-	-
38	42	52	68	85	87	P31	SEG50	-	-	-	-	TBCOUT0	TBCOUT1	-
39	43	53	69	86	88	P32	SEG51	SU1_RXD1	SU1_RXD0	-	-	-	-	-
40	44	54	70	87	89	P33	SEG52	SU1_TXD1	-	-	TMH3OUT	-	-	-
-	-	49	65	82	84	P40	SEG47	SU5_TXD1	-	-	-	-	-	-
-	40	50	66	83	85	P41	SEG48	-	-	-	-	-	-	-
-	-	63	79	96	98	P42	SEG61	SU3_TXD1	-	-	-	-	-	-
48	52	64	80	100	2	P43	-	-	-	-	-	TBCOUT0	TBCOUT1	AIN10
-	-	9	12	17	19	P44	DACOUT1	SU4_RXD1	SU4_RXD0	-	FTM3N *1	-	-	-
-	-	10	13	18	20	P45	-	SU4_TXD1	-	-	-	-	-	-
-	-	13	16	21	23	P46	-	-	-	I2CU0_SDA *1	FTM1N *1	-	-	-
-	11	14	17	22	24	P47	-	SU0_SCLK *1	-	I2CU0_SCL *2	FTM1P *1	-	-	-
24	25	29	33	38	40	P50	EXI8 SEG5	-	-	-	-	-	-	-
-	26	30	34	39	41	P51	SEG6	-	-	-	-	-	-	-
-	-	31	35	40	42	P52	SEG7	SU4_RXD1	SU4_RXD0	-	-	-	-	-
-	-	32	36	41	43	P53	SEG8	SU4_TXD1	-	-	-	-	-	-
-	-	33	43	55	57	P54	SEG20	SU2_RXD1	SU2_RXD0	-	TMH7OUT	-	-	-
-	-	34	44	56	58	P55	SEG21	SU2_TXD1	-	-	-	-	-	-
-	39	47	57	69	71	P56	SEG34	SU2_RXD0 SU2_SIN	-	-	-	-	-	AIN12
-	-	48	58	70	72	P57	SEG35	SU2_TXD0 SU2_SOUT	SU2_TXD1	-	-	-	-	AIN13
41	45	55	71	88	90	P60	SEG53	-	-	I2CM1_SCL	-	-	-	-
42	46	56	72	89	91	P61	SEG54	-	-	I2CM1_SDA	-	-	-	-
43	47	57	73	90	92	P62	SEG55	-	-	-	FTM4N	-	CMP1P	-
44	48	58	74	91	93	P63	SEG56	-	-	-	FTM4P	-	CMP1M	-
45	49	59	75	92	94	P64	EXI9 SEG57	SU3_RXD0 SU3_SIN	-	-	FTM5P	-	-	-
46	50	60	76	93	95	P65	SEG58	SU3_TXD0 SU3_SOUT	SU3_TXD1	-	FTM5N	-	-	AIN8
47	51	61	77	94	96	P66	SEG59	SU3_SCLK	-	-	-	-	-	AIN9
-	-	62	78	95	97	P67	SEG60	SU3_RXD1	SU3_RXD0	-	-	-	-	-
-	-	20	24	29	31	P70	-	-	-	-	TMH6OUT	-	-	-
15	16	19	23	28	30	V _{L3}	-	-	-	-	-	-	-	-
14	15	18	22	27	29	V _{L2}	-	-	-	-	-	-	-	-
13	14	17	21	26	28	V _{L1}	-	-	-	-	-	-	-	-
12	13	16	20	25	27	C ₂	-	-	-	-	-	-	-	-
11	12	15	19	24	26	C ₁	-	-	-	-	-	-	-	-
-	-	-	18	23	25	P76	EXI10	-	-	-	-	-	-	-
-	-	-	-	99	1	P77	SEG64	-	-	-	-	-	-	-

*1: No assignment to ML62Q1500 Series.

*2: No assignment to ML62Q1500 Series and products of 52 PIN-package.

*3: The pins of name with DACOUT1, SU2, SU3, SU4, SU5, TMH6, TMH7, AIN12 or AIN13 are not assigned to products of 48/52/64 PIN-packages.

Table 3 Pin List (3/3)

Pin No.					Pin name (1 st func)	1 st func. others	2 nd func. SIU	3 rd func. SIU	4 th func. I2C	5 th func. Timer	6 th func. others	7 th func. others	8 th func. ADC
48 Pin	52 Pin	64 Pin	80 pin	TOFP100									
-	-	-	9	9	11	P80	-	SU4_RXD0 SU4_SIN	-	-	-	-	-
-	-	-	10	10	12	P81	-	SU4_TXD0 SU4_SOUT	SU4_TXD1	-	-	-	-
-	-	-	11	11	13	P82	-	SU4_SCLK	-	-	-	-	-
-	-	-	-	12	14	P83	-	SU5_RXD0	-	-	-	-	-
-	-	-	-	13	15	P84	-	SU5_TXD0	SU5_TXD1 *1	-	-	-	-
-	-	-	-	14	16	P85	-	-	-	-	-	-	-
-	-	-	-	15	17	P86	-	-	-	FTM7P *1	-	-	-
-	-	-	-	16	18	P87	-	-	-	FTM7N *1	-	-	-
-	-	-	-	42	44	P90	SEG9	-	-	-	-	-	-
-	-	-	-	43	45	P91	SEG10	-	-	-	-	-	-
-	-	-	-	44	46	P92	SEG11	-	-	-	-	-	-
-	-	-	37	45	47	P93	SEG12	SU4_RXD0 SU4_SIN	-	-	FTM6P	-	-
-	-	-	38	46	48	P94	SEG13	SU4_TXD0 SU4_SOUT	SU4_TXD1	-	FTM6N	-	-
-	-	-	39	47	49	P95	SEG14	SU4_SCLK	-	-	-	-	-
-	-	-	40	48	50	P96	SEG15	-	-	-	-	-	-
-	-	-	-	49	51	P97	SEG16	-	-	-	-	-	-
-	-	-	-	50	52	PA0	SEG17	-	-	-	-	-	-
-	-	-	-	53	55	PA1	SEG18	-	-	-	-	-	-
-	-	-	-	54	56	PA2	SEG19	-	-	-	-	-	-
-	-	-	59	71	73	PA3	EXI11 SEG36	SU2_SCLK	-	-	FTM7P	-	AIN14
-	-	-	60	72	74	PA4	SEG37	-	-	-	FTM7N	-	AIN15
-	-	-	-	73	75	PA5	SEG38	-	-	-	-	-	-
-	-	-	-	74	76	PA6	SEG39	-	-	-	-	-	-
-	-	-	-	75	77	PA7	SEG40	-	-	-	-	-	-
-	-	-	-	76	78	PB0	SEG41	-	-	-	-	-	-
-	-	-	-	77	79	PB1	SEG42	-	-	-	-	-	-
-	-	-	61	78	80	PB2	SEG43	SU5_RXD0 SU5_SIN	-	-	-	-	-
-	-	-	62	79	81	PB3	SEG44	SU5_TXD0 SU5_SOUT	SU5_TXD1	-	-	-	-
-	-	-	63	80	82	PB4	SEG45	SU5_SCLK	-	-	-	-	-
-	-	-	64	81	83	PB5	SEG46	SU5_RXD1	SU5_RXD0	-	-	-	-
-	-	-	-	97	99	PB6	SEG62	-	-	-	-	-	-
-	-	-	-	98	100	PB7	SEG63	-	-	-	-	-	-

*1: No assignment to ML62Q1500 Series.

PIN DESCRIPTION

Table 4 Pin Description (1/7)

Function	Signal name	Pin name	I/O	Description	Logic
Power	—	V _{SS}	—	Negative power supply pin (-)	—
	—	V _{DD}	—	Positive power supply pin (+). Connect a capacitor C _V between this pin and V _{SS} .	—
	—	V _{DDL}	—	Power supply pin for internal logic (internal regulator's output). Connect a capacitor C _L (1μF) between this pin and V _{SS} .	—
Test	TEST0	P00	I/O	Input for testing, is used as on-chip debug interface and ISP function. P00 is initialized as pull-up input mode by the system reset.	—
Un used	NC	NC	—	Connect to V _{SS} .	—
System	V _{REF}	P23	—	Reference voltage output	—
	RESET_N	RESET_N	I	Reset input. Applying "L" level shifts the MCU in system reset mode. Applying "H" level shifts the CPU in program running mode. Used for on-chip debug interface and ISP function. No pull-up resistor is installed.	Negative
	XT0	XT0	I	Low speed crystal oscillation pins Connect 32.768kHz crystal resonator and Connect capacitors between the pin and V _{SS} .	—
	XT1	XT1	O		—
	OUTLSCLK	P02 P21	O	Low-speed clock output.	—
	OUTHCLK	P03 P22	O	High-speed clock output.	—
General input port (GPI)	PI00, PI01	XT0, XT1	I	General purpose input. Not available as general inputs when using the crystal resonator.	Positive
General port (GPIO)	P00	P00	I/O	General purpose I/O port - High-impedance - Input with Pull-UP (initial value) - Input without Pull-UP - CMOS output - N-channel open drain output Not available to use as I/O pin when using for on-chip debug interface or ISP function.	Positive
	P01 – P07	P01 – P07	I/O	General purpose I/O - High-impedance (initial value) - Input with Pull-UP - Input without Pull-UP - CMOS output - N-channel open drain output	Positive
	P10 – P17	P10 – P17			
	P20 – P27	P20 – P27			
	P30 – P33	P30 – P33			
	P40 – P47	P40 – P47			
	P50 – P57	P50 – P57			
	P60 – P67	P60 – P67			
	P70, P76, P77	P70, P76, P77			
	P80 – P87	P80 – P87			
	P90 – P97	P90 – P97			
	PA0 – PA7	PA0 – PA7			
PB0 – PB7	PB0 – PB7				

Table 4 Pin Description (2/7)

Function	Signal name	Pin name	I/O	Description	Logic
UART	SU0_TXD0	P03	O	Serial communication unit0 UART0 data output	Positive
		P13			
	SU0_RXD0	P02	I	Serial communication unit0 Full-duplex data input Serial communication unit0 UART0 data input	Positive
		P07			
		P12			
		P17			
	SU0_TXD1	P03	O	Serial communication unit0 Full-duplex data output Serial communication unit0 UART1 data output	Positive
		P10			
		P13			
		P20			
	SU0_RXD1	P07	I	Serial communication unit0 UART1 data input	Positive
		P17			
	SU1_TXD0	P22	O	Serial communication unit1 UART0 data output	Positive
		P25			
	SU1_RXD0	P21	I	Serial communication unit1 Full-duplex data input Serial communication unit1 UART0 data input	Positive
		P24			
		P26			
		P32			
	SU1_TXD1	P22	O	Serial communication unit1 Full-duplex data output Serial communication unit1 UART1 data output	Positive
		P25			
		P27			
		P33			
	SU1_RXD1	P26	I	Serial communication unit1 UART1 data input	Positive
		P32			
	SU2_TXD0	P57	O	Serial communication unit2 UART0 data output	Positive
	SU2_RXD0	P54	I	Serial communication unit2 Full-duplex data input Serial communication unit2 UART0 data input	Positive
		P56			
	SU2_TXD1	P55	O	Serial communication unit2 Full-duplex data output Serial communication unit2 UART1 data output	Positive
		P57			
	SU2_RXD1	P54	I	Serial communication unit2 UART1 data input	Positive
SU3_TXD0	P65	O	Serial communication unit3 UART0 data output	Positive	
SU3_RXD0	P64	I	Serial communication unit3 Full-duplex data input Serial communication unit3 UART0 data input	Positive	
	P67				
SU3_TXD1	P42	O	Serial communication unit3 Full-duplex data output Serial communication unit3 UART1 data output	Positive	
	P65				
SU3_RXD1	P67	I	Serial communication unit3 UART1 data input	Positive	
SU4_TXD0	P81	O	Serial communication unit4 UART0 data output	Positive	
	P94				
SU4_RXD0	P44	I	Serial communication unit4 Full-duplex data input Serial communication unit4 UART0 data input	Positive	
	P52				
	P80				
	P93				
SU4_TXD1	P45	O	Serial communication unit4 Full-duplex data output Serial communication unit4 UART1 data output.	Positive	
	P53				
	P81				
	P94				
SU4_RXD1	P44	I	Serial communication unit4 UART1 data input	Positive	
	P52				
SU5_TXD0	P84	O	Serial communication unit5 UART0 data output	Positive	
	PB3				
SU5_RXD0	P83	I	Serial communication unit5 Full-duplex data input Serial communication unit5 UART0 data input	Positive	
	PB2				
	PB5				
SU5_TXD1	P40	O	Serial communication unit5 Full-duplex data output Serial communication unit5 UART1 data output.	Positive	
	P84				
	PB3				
SU5_RXD1	PB5	I	Serial communication unit5 UART1 data input	Positive	

Table 4 Pin Description (3/7)

Function	Signal name	Pin name	I/O	Description	Logic
Synchronous Serial Port	SU0_SIN	P02	I	Serial communication unit0 Synchronous serial data input	Positive
		P12			
	SU0_SCLK	P04	I/O	Serial communication unit0 Synchronous serial clock I/O	Positive
		P11			
		P47			
	SU0_SOUT	P03	O	Serial communication unit0 Synchronous serial data output	Positive
		P13			
	SU1_SIN	P21	I	Serial communication unit1 Synchronous serial data input	Positive
		P24			
	SU1_SCLK	P16	I/O	Serial communication unit1 Synchronous serial clock I/O	Positive
		P23			
	SU1_SOUT	P22	O	Serial communication unit1 Synchronous serial data output	Positive
		P25			
	SU2_SIN	P56	I	Serial communication unit2 Synchronous serial data	Positive
	SU2_SCLK	PA3	I/O	Serial communication unit2 Synchronous serial clock I/O	Positive
	SU2_SOUT	P57	O	Serial communication unit2 Synchronous serial data output	Positive
	SU3_SIN	P64	I	Serial communication unit3 Synchronous serial data input	Positive
	SU3_SCLK	P66	I/O	Serial communication unit3 Synchronous serial clock I/O	Positive
	SU3_SOUT	P65	O	Serial communication unit3 Synchronous serial data output	Positive
	SU4_SIN	P80	I	Serial communication unit4 Synchronous serial data input	Positive
P93					
SU4_SCLK	P82	I/O	Serial communication unit4 Synchronous serial clock I/O	Positive	
	P95				
SU4_SOUT	P81	O	Serial communication unit4 Synchronous serial data output	Positive	
	P94				
SU5_SIN	PB2	I	Serial communication unit5 Synchronous serial data input	Positive	
SU5_SCLK	PB4	I/O	Serial communication unit5 Synchronous serial clock I/O	Positive	
SU5_SOUT	PB3	O	Serial communication unit5 Synchronous serial data output	Positive	
I ² C Bus	I2CU0_SDA	P03	I/O	I ² C Unit0 (Master and Salve) Data I/O N-channel open drain Connect a pull-up resistor externally	Positive
		P15			
		P26			
		P46			
	I2CU0_SCL	P02	I/O	I ² C Unit0 (Master and Salve) Clock I/O N-channel open drain output Connect a pull-up resistor externally	Positive
		P04			
		P16			
		P27			
	I2CM0_SDA	P06	I/O	I ² C Master0 Data I/O pin N-channel open drain output Connect a pull-up resistor externally	Positive
		P22			
	I2CM0_SCL	P07	I/O	I ² C Master0 Clock I/O N-channel open drain output Connect a pull-up resistor externally	Positive
		P23			
I2CM1_SDA	P61	I/O	I ² C Master1 Data I/O N-channel open drain output Connect a pull-up resistor externally	Positive	
I2CM1_SCL	P60	I/O	I ² C Master1 Clock I/O N-channel open drain output Connect a pull-up resistor externally	Positive	

Table 4 Pin Description (4/7)

Function	Signal name	Pin name	I/O	Description	Logic
Functional Timer (FTM)	FTM0P	P02	O	Functional Timer0 P output	Positive
	FTM0N	P03	O	Functional Timer0 N output	Negative
	FTM1P	P17	O	Functional Timer1 P output	Positive
		P47			
	FTM1N	P20	O	Functional Timer1 N output	Negative
		P46			
	FTM2P	P21	O	Functional Timer2 P output	Positive
	FTM2N	P22	O	Functional Timer2 N output	Negative
	FTM3P	P01	O	Functional Timer3 P output	Positive
		P26			
	FTM3N	P27	O	Functional Timer3 N output	Negative
		P44			
	FTM4P	P63	O	Functional Timer4 P output	Positive
	FTM4N	P62	O	Functional Timer4 N output	Negative
	FTM5P	P64	O	Functional Timer5 P output	Positive
	FTM5N	P65	O	Functional Timer5 N output	Negative
	FTM6P	P93	O	Functional Timer6 P output	Positive
	FTM6N	P94	O	Functional Timer6 N output	Negative
	FTM7P	P86	O	Functional Timer7 P output	Positive
		PA3			
FTM7N	P87	O	Functional Timer7 N output	Negative	
	PA4				
	EXTRG0	P02	I	Functional Timer event trigger input	—
	EXTRG1	P03	I	Functional Timer event trigger input	—
	EXTRG2	P04	I	Functional Timer event trigger input	—
	EXTRG3	P17	I	Functional Timer event trigger input	—
	EXTRG4	P21	I	Functional Timer event trigger input	—
	EXTRG5	P23	I	Functional Timer event trigger input	—
	EXTRG6	P26	I	Functional Timer event trigger input	—
	EXTRG7	P27	I	Functional Timer event trigger input	—
16-bit Timer	TMH0OUT	P04	O	16bit General Timer 0 output	Positive
	TMH1OUT	P13	O	16bit General Timer 1 output	Positive
	TMH2OUT	P23	O	16bit General Timer 2 output	Positive
		P13			
	TMH3OUT	P33	O	16bit General Timer 3 output	Positive
		P12			
	TMH4OUT	P12	O	16bit General Timer 4 output	Positive
	TMH5OUT	P16	O	16bit General Timer 5 output	Positive
	TMH6OUT	P70	O	16bit General Timer 6 output	Positive
TMH7OUT	P54	O	16bit General Timer 7 output	Positive	
	EXTRG0	P02	I	16bit Timer trigger input	—
	EXTRG1	P03	I	16bit Timer trigger input	—
Low-speed Time Base Counter (LTBC)	TBCOUT0	P01	O	The virtual frequency adjustment signal output	Positive
		P17			
		P26			
		P31			
	TBCOUT1	P43	O	Low-speed Time Base Counter 1Hz/2Hz output	Positive
		P01			
		P20			
		P27			
	P31				
	P43				
Buzzer	BZ0P	P17	O	Buzzer output (positive phase)	Positive
		P26			
	BZ0N	P20	O	Buzzer output (negative phase)	Negative
		P27			

Table 4 Pin Description (5/7)

Function	Signal name	Pin name	I/O	Description	Logic
External Interrupt	EXI0	P02	I	External Interrupt 0 Input	—
	EXI1	P03	I	External Interrupt 1 Input	—
	EXI2	P04	I	External Interrupt 2 Input	—
	EXI3	P17	I	External Interrupt 3 Input	—
	EXI4	P21	I	External Interrupt 4 Input	—
	EXI5	P23	I	External Interrupt 5 Input	—
	EXI6	P26	I	External Interrupt 6 Input	—
	EXI7	P27	I	External Interrupt 7 Input	—
	EXI8	P50	I	External Interrupt 8 Input	—
	EXI9	P64	I	External Interrupt 9 Input	—
	EXI10	P76	I	External Interrupt 10 Input	—
Successive approximation type A/D converter (SA-ADC)	V _{REF}	P23	—	SA-ADC external reference voltage input	—
	AIN0	P17	I	SA-ADC channel 0 input	—
	AIN1	P20	I	SA-ADC channel 1 input	—
	AIN2	P21	I	SA-ADC channel 2 input	—
	AIN3	P22	I	SA-ADC channel 3 input	—
	AIN4	P24	I	SA-ADC channel 4 input	—
	AIN5	P25	I	SA-ADC channel 5 input	—
	AIN6	P26	I	SA-ADC channel 6 input	—
	AIN7	P27	I	SA-ADC channel 7 input	—
	AIN8	P65	I	SA-ADC channel 8 input	—
	AIN9	P66	I	SA-ADC channel 9 input	—
	AIN10	P43	I	SA-ADC channel 10 input	—
	AIN11	P03	I	SA-ADC channel 11 input	—
	AIN12	P56	I	SA-ADC channel 12 input	—
	AIN13	P57	I	SA-ADC channel 13 input	—
	AIN14	PA3	I	SA-ADC channel 14 input	—
AIN15	PA4	I	SA-ADC channel 15 input	—	
Analog comparator	CMP0P	P03	I	Comparator input 0 (noninverting input)	—
	CMP0M	P02	I	Comparator input 0 (inverting input)	—
	CMP1P	P62	I	Comparator input 1 (noninverting input)	—
	CMP1M	P63	I	Comparator input 1 (inverting input)	—
D/A converter	DACOUT0	P01	O	D/A converter 0 output	—
	DACOUT1	P44	O	D/A converter 1 output	—

Table 4 Pin Description (6/7)

Function	Signal name	Pin name	I/O	Description	Logic
LCD driver	COM0	P04	—	Common output	—
	COM1	P05	—	Common output	—
	COM2	P06	—	Common output	—
	COM3/SEG0	P07	—	Common/Segment output shared	—
	COM4/SEG1	P10	—	Common/Segment output shared	—
	COM5/SEG2	P11	—	Common/Segment output shared	—
	COM6/SEG3	P12	—	Common/Segment output shared	—
	COM7/SEG4	P13	—	Common/Segment output shared	—
	SEG5	P50	—	Segment output	—
	SEG6	P51	—	Segment output	—
	SEG7	P52	—	Segment output	—
	SEG8	P53	—	Segment output	—
	SEG9	P90	—	Segment output	—
	SEG10	P91	—	Segment output	—
	SEG11	P92	—	Segment output	—
	SEG12	P93	—	Segment output	—
	SEG13	P94	—	Segment output	—
	SEG14	P95	—	Segment output	—
	SEG15	P96	—	Segment output	—
	SEG16	P97	—	Segment output	—
	SEG17	PA0	—	Segment output	—
	SEG18	PA1	—	Segment output	—
	SEG19	PA2	—	Segment output	—
	SEG20	P54	—	Segment output	—
	SEG21	P55	—	Segment output	—
	SEG22	P14	—	Segment output	—
	SEG23	P15	—	Segment output	—
	SEG24	P16	—	Segment output	—
	SEG25	P17	—	Segment output	—
	SEG26	P20	—	Segment output	—
	SEG27	P21	—	Segment output	—
	SEG28	P22	—	Segment output	—
	SEG29	P23	—	Segment output	—
	SEG30	P24	—	Segment output	—
	SEG31	P25	—	Segment output	—
	SEG32	P26	—	Segment output	—
	SEG33	P27	—	Segment output	—
	SEG34	P56	—	Segment output	—
	SEG35	P57	—	Segment output	—
	SEG36	PA3	—	Segment output	—
	SEG37	PA4	—	Segment output	—
	SEG38	PA5	—	Segment output	—
	SEG39	PA6	—	Segment output	—
	SEG40	PA7	—	Segment output	—
	SEG41	PB0	—	Segment output	—
	SEG42	PB1	—	Segment output	—
SEG43	PB2	—	Segment output	—	
SEG44	PB3	—	Segment output	—	
SEG45	PB4	—	Segment output	—	
SEG46	PB5	—	Segment output	—	

Table 4 Pin Description (7/7)

Function	Signal name	Pin name	I/O	Description	Logic	
LCD driver	SEG47	P40	—	Segment output	—	
	SEG48	P41	—	Segment output	—	
	SEG49	P30	—	Segment output	—	
	SEG50	P31	—	Segment output	—	
	SEG51	P32	—	Segment output	—	
	SEG52	P33	—	Segment output	—	
	SEG53	P60	—	Segment output	—	
	SEG54	P61	—	Segment output	—	
	SEG55	P62	—	Segment output	—	
	SEG56	P63	—	Segment output	—	
	SEG57	P64	—	Segment output	—	
	SEG58	P65	—	Segment output	—	
	SEG59	P66	—	Segment output	—	
	SEG60	P67	—	Segment output	—	
	SEG61	P42	—	Segment output	—	
	SEG62	PB6	—	Segment output	—	
	SEG63	PB7	—	Segment output	—	
	SEG64	P77	—	Segment output	—	
		C ₁ ,C ₂	C ₁ ,C ₂	—	LCD bias power source generation capacitor connection	—
		V _{L1} ~V _{L3}	V _{L1} ~V _{L3}	—	LCD bias power source Connect the capacitors (C _{L1} ,C _{L2} ,C _{L3}) between the pin and Vss.	—

TERMINATION OF UNUSED PINS

Table 5 Termination of unused pins

Pin	pin termination
NC	Connect to V_{SS}
RESET_N	Connect to V_{DD}
P00/TEST0	Connect to V_{DD} with initial state (pulled-up input mode)
XT0/PI00, XT1/PI01	Open the pins with the internal initial condition of Hi-impedance mode.
P01 to P07	
P10 to P17	
P20 to P27	
P30 to P33	
P40 to P47	
P50 to P57	
P60 to P67	
P70, P76 , P77	
P80 to P87	
P90 to P97	
PA0 to PA7	
PB0 to PB7	
C_1, C_2	Open
V_{L1}, V_{L2}	Open
V_{L3}	Connect to V_{DD} through a resistor

Note:

- Terminate unused input pins according to the table 5 in order to avoid unexpected through-current in the pins.

ELECTRICAL CHARACTERISTICS

Absolute Maximum Ratings

(V_{SS} = 0V)

Parameter	Symbol	Condition	Rating	Unit	
Power supply voltage 1	V _{DD}	Ta = +25°C	-0.3 to +6.5	V	
Power supply voltage 2	V _{DDL}	Ta = +25°C	-0.3 to +2.0	V	
Power supply voltage 3	V _{L3}	Ta = +25°C	-0.3 to +6.5	V	
Power supply voltage 4	V _{L1} , V _{L2}	Ta = +25°C	-0.3 to V _{L3} +0.3* ¹	V	
Input voltage	V _{IN}	Ta = +25°C	-0.3 to V _{DD} +0.3* ¹	V	
Output voltage1	V _{OUT1}	Ta = +25°C	-0.3 to V _{DD} +0.3* ¹	V	
Output voltage2 (COM0~COM7, SEG0~SEG64)	V _{OUT2}	Ta = +25°C	-0.3 to +6.5	V	
"H" level output current	I _{OUTH}	Ta = +25°C	1pin	-40* ²	mA
			Total	-180* ²	
"L" level output current	I _{OUTL}	Ta = +25°C	1pin	+40	mA
			Total	+180	
Power dissipation	PD	Ta = +25°C	1	W	
Storage temperature	T _{STG}	—	-55 to +150	°C	

*¹ 6.5V or lower*² The current flowing out the LSI through the pin is described in the negative number.

The applicable maximum current is the absolute value.

For example, -1mA means the maximum current 1mA flows out the LSI through the pin.

[Note]

Stresses above the absolute maximum ratings listed in the above table may cause permanent damage to the device.

These are stress ratings only and functional operation of the device at these conditions is not implied.

Recommended Operating Conditions

(V_{SS} = 0V)

Parameter	Symbol	Condition	Range	Unit
Operating temperature(Ambient)	Ta	—	-40 to +105	°C
Operating temperature(Chip-Junction)	Tj	—	-40 to +115	°C
Operating voltage 1	V _{DD}	—	1.6 to 5.5	V
Operating voltage 2	V _{L3}	External supply method	2.7 to 5.5	V
Operating voltage 3	V _{L2}	External supply method	2/3 x V _{L3}	V
Operating voltage 4	V _{L1}	External supply method	1/3 x V _{L3}	V
Operating frequency (CPU)	f _{OP}	V _{DD} = 1.6 to 5.5V	30k to 4M	Hz
		V _{DD} = 1.8 to 5.5V	30k to 25M	
V _{DDL} pin external capacitance	C _L	—	1.0 ±30%	μF
V _{L1} , V _{L2} , V _{L3} pin external capacitance	C _{L1} , C _{L2} , C _{L3}	—	0.47±30% or	μF
			1.0±30%	
C ₁ and C ₂ pin external capacitance	C ₁₂	—	0.47±30% or 1.0±30%	μF

Thermal characteristics

The maximum chip-junction temperature, T_{jmax} , may be calculated using the following equation.

$$T_{jmax} = T_{amax} + P_{Dmax} \times \theta_{ja}$$

T_{amax} : maximum ambient temperature

P_{Dmax} : LSI maximum power dissipation

θ_{ja} : Package junction to ambient thermal resistance

Design a Mounting board by considering heat radiation such as power dissipation and ambient temperature to satisfy the recommended conditions.

The following table shows the each package's thermal resistance for thermal design reference estimated by simulation based on the PCB (printed circuit board) conditions define as a below.

Parameter	Symbol	Package type	Value		Unit
			L1	L2	
Thermal resistance	θ_{ja}	TQFP48	63.6	57.8	°C/W
		TQFP52	61.7	56.7	
		TQFP64	63.2	58.2	
		QFP64	47.2	43.3	
		QFP80	55.5	51.6	
		TQFP100	48.0	43.3	
		QFP100	104.7	101.3	

PCB conditions:

PCB name	L1	L2	Unit
PCB size (L / W / T)	114.3 / 76.2 / 1.6	114.3 / 76.2 / 1.6	mm
Number of layer	1	2	layer
Wiring density	60% (top layer)	60%(top and bottom layer)	—
Wind condition	No wind (0m/s)		—

Current Consumption 1

Product: ML62Q1700, ML62Q1701, ML62Q1702, ML62Q1703, ML62Q1704, ML62Q1710,
ML62Q1711, ML62Q1712, ML62Q1713, ML62Q1714, ML62Q1720, ML62Q1721,
ML62Q1722, ML62Q1723, ML62Q1724

(V_{DD}=1.6 to 5.5V, V_{SS}=0V, Ta=-40 to +105°C, unless otherwise specified)

Parameter	Symbol	Condition	Min.	Typ.* ³	Max.	Unit	Measuring circuit
Supply current 0	IDD0	CPU is in STOP-D state. Low-speed RC1K/RC32K and PLL oscillation are stopped.	Ta = -40 to +85 °C	—	0.8	37	μA
			Ta = -40 to +105 °C	—		75	
Supply current 1	IDD1	CPU is in STOP state. Low-speed RC1K/RC32K and PLL oscillation are stopped.	Ta = -40 to +85 °C	—	1.0	40	μA
			Ta = -40 to +105 °C	—		80	
Supply current 2-1	IDD2-1	Low-speed RC32K Oscillating. CPU is in HALT state (LTBC and WDT are operating ^{*1}). PLL oscillation is stopped.	Ta = -40 to +85 °C	—	4.9	42	μA
			Ta = -40 to +105 °C	—		85	
Supply current 2-2	IDD2-2	Low-speed Crystal Oscillating. ^{*4} CPU is in HALT state (LTBC and WDT are operating ^{*1}). PLL oscillation is stopped.	Ta = -40 to +85 °C	—	3.3	42	μA
			Ta = -40 to +105 °C	—		85	
Supply current 3	IDD3	CPU: Running with low-speed RC32K oscillation clock ^{*1*2} PLL oscillation is stopped.	Ta = -40 to +105 °C	—	17	105	μA
Supply current 4	IDD4	CPU: Running with 16MHz PLL oscillating clock ^{*2} PLL 16MHz is oscillating. V _{DD} =1.8~5.5V	Ta = -40 to +105 °C	—	3.4	4.5	mA
Supply current 5	IDD5	CPU: Running with 24MHz PLL oscillating clock ^{*2} PLL 24MHz is oscillating. V _{DD} =1.8~5.5V	Ta = -40 to +105 °C	—	4.8	6.0	

1

*¹ LTBC and WDT is operating, Significant bits of BLKCON0-3 and BRECON0-3 registers are all "1"

*² CPU running in wait mode

*³ On the condition of V_{DD}=3.0V, Ta=+25°C

*⁴ When the noise filter is not used in the low power consumption mode

Current Consumption 2

Product: ML62Q1725, ML62Q1726, ML62Q1727, ML62Q1733, ML62Q1734, ML62Q1735, ML62Q1736,
ML62Q1737, ML62Q1743, ML62Q1744, ML62Q1745, ML62Q1746, ML62Q1747

(V_{DD}=1.6 to 5.5V, V_{SS}=0V, Ta=-40 to +105°C, unless otherwise specified)

Parameter	Symbol	Condition	Min.	Typ.* ³	Max.	Unit	Measuring circuit
Supply current 0	IDD0	CPU is in STOP-D state. Low-speed RC1K/RC32K and PLL oscillation are stopped.	Ta = -40 to +85 °C	—	1.0	55	μA
			Ta = -40 to +105 °C	—		110	
Supply current 1	IDD1	CPU is in STOP state. Low-speed RC1K/RC32K and PLL oscillation are stopped.	Ta = -40 to +85 °C	—	1.5	60	μA
			Ta = -40 to +105 °C	—		120	
Supply current 2-1	IDD2-1	Low-speed RC32K Oscillating. CPU is in HALT state (LTBC and WDT are operating ^{*1}). PLL oscillation is stopped.	Ta = -40 to +85 °C	—	5.7	76	μA
			Ta = -40 to +105 °C	—		135	
Supply current 2-2	IDD2-2	Low-speed Crystal Oscillating. ^{*4} CPU is in HALT state (LTBC and WDT are operating ^{*1}). PLL oscillation is stopped.	Ta = -40 to +85 °C	—	4.5	76	μA
			Ta = -40 to +105 °C	—		135	
Supply current 3	IDD3	CPU: Running with low-speed RC32K oscillation clock ^{*1*2} PLL oscillation is stopped.	Ta = -40 to +105 °C	—	20	150	μA
Supply current 4	IDD4	CPU: Running with 16MHz PLL oscillating clock ^{*2} PLL 16MHz is oscillating. V _{DD} =1.8~5.5V	Ta = -40 to +105 °C	—	4.0	5.0	mA
Supply current 5	IDD5	CPU: Running with 24MHz PLL oscillating clock ^{*2} PLL 24MHz is oscillating. V _{DD} =1.8~5.5V	Ta = -40 to +105 °C	—	5.7	7.0	

1

*¹ LTBC and WDT is operating, Significant bits of BLKCON0-3 and BRECON0-3 registers are all "1"

*² CPU running in wait mode

*³ On the condition of V_{DD}=3.0V, Ta=+25°C

*⁴ When the noise filter is not used in the low power consumption mode

Current Consumption 3

Product: ML62Q1728, ML62Q1729, ML62Q1738, ML62Q1739, ML62Q1748, ML62Q1749

(V_{DD}=1.6 to 5.5V, V_{SS}=0V, Ta=-40 to +105°C, unless otherwise specified)

Parameter	Symbol	Condition	Min.	Typ.* ³	Max.	Unit	Measuring circuit
Supply current 0	IDD0	CPU is in STOP-D state. Low-speed RC1K/RC32K and PLL oscillation are stopped.	Ta = -40 to +85 °C	—	1.2	57	μA
			Ta = -40 to +105 °C	—		140	
Supply current 1	IDD1	CPU is in STOP state. Low-speed RC1K/RC32K and PLL oscillation are stopped.	Ta = -40 to +85 °C	—	1.8	62	μA
			Ta = -40 to +105 °C	—		150	
Supply current 2-1	IDD2-1	Low-speed RC32K Oscillating. CPU is in HALT state (LTBC and WDT are operating ^{*1}). PLL oscillation is stopped.	Ta = -40 to +85 °C	—	6.0	78	μA
			Ta = -40 to +105 °C	—		165	
Supply current 2-2	IDD2-2	Low-speed Crystal Oscillating. ^{*4} CPU is in HALT state (LTBC and WDT are operating ^{*1}). PLL oscillation is stopped.	Ta = -40 to +85 °C	—	4.5	78	μA
			Ta = -40 to +105 °C	—		165	
Supply current 3	IDD3	CPU: Running with low-speed RC32K oscillation clock ^{*1*2} PLL oscillation is stopped.	Ta = -40 to +105 °C	—	20	190	μA
Supply current 4	IDD4	CPU: Running with 16MHz PLL oscillating clock ^{*2} PLL 16MHz is oscillating. V _{DD} =1.8~5.5V	Ta = -40 to +105 °C	—	4.0	5.0	mA
Supply current 5	IDD5	CPU: Running with 24MHz PLL oscillating clock ^{*2} PLL 24MHz is oscillating. V _{DD} =1.8~5.5V	Ta = -40 to +105 °C	—	5.7	7.0	

1

*¹ LTBC and WDT is operating, Significant bits of BLKCON0-3 and BRECON0-3 registers are all "1"*² CPU running in wait mode*³ On the condition of V_{DD}=3.0V, Ta=+25°C*⁴ When the noise filter is not used in the low power consumption mode

Low speed Crystal Oscillation

(V_{DD}=1.6 to 5.5V, V_{SS}=0V, Ta=-40 to +105°C, unless otherwise specified)

Parameter	Symbol	Condition	Range			Unit
			Min.	Typ.	Max.	
Crystal oscillation frequency *1 *2	f _{XTL}	—	—	32.768	—	kHz
Crystal oscillation start time	T _{XTL}	—	—	—	2	s

*1: The oscillation frequency is determined by the oscillation circuit, crystal resonator and the external capacitance (C_{GL}/C_{DL}). As those parameters changes depending the crystal resonator, it requires evaluation on the actual PCB circuit for matching. Ask crystal resonator makers for matching and confirm the oscillation characteristics.

*2: The quality of oscillation characteristics might be lost, depending on material of PCB, condition of wiring capacitance or parasitic capacitance on the external circuits. Note for designing the external circuit.

- Make the wires on the external circuit as short as possible.
- Place the crystal resonator and oscillation circuit as close to the MCU as possible and make the wires between the external capacitance and crystal resonator as short as possible.
- Ensure no signal line flowing big current runs near the oscillation circuit.
- Ensure no signal line runs under and near the oscillation circuit.
- Make ground of external capacitance the same as MCU ground V_{SS} pin and connect them to the ground that has low variation of current and voltage.
- The quality of oscillation characteristics might be lost depending on operating environment due to moisture absorption of PCB and condensation of PCB surface, recommended to have measures such as covering the oscillation circuit with resin.

Low speed Crystal Oscillation external circuit example

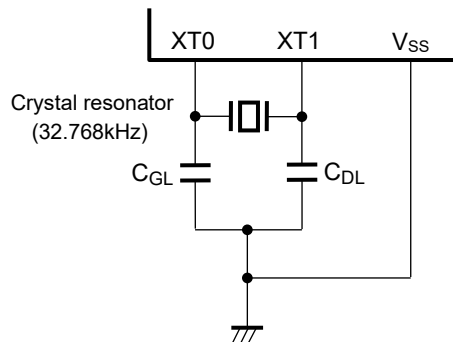

External Clock Input

(V_{DD}=1.6 to 5.5V, V_{SS}=0V, Ta=-40 to +105°C, unless otherwise specified)

Parameter	Symbol	Condition	Range			Unit
			Min.	Typ.	Max.	
Input Frequency	f _{EXCK}	—	Typ. -1.0%	32.768	Typ. +1.0%	kHz
Input pulse width	t _{EXCKW}	—	1/f _{EXCK} x 0.4		1/f _{EXCK} x 0.6	s

On-chip Oscillator

(V_{DD}=1.6 to 5.5V, V_{SS}=0V, Ta=-40 to +105°C, unless otherwise specified)

Parameter	Symbol	Condition	Min.	Typ.	Max.	Unit	Measuring circuit
Low-speed RC oscillator frequency accuracy 1 Without software adjustment	f _{RCL1}	Ta= +25°C V _{DD} = 1.8 to 5.5V	Typ. -1.0%	32.768	Typ. +1.0%	kHz	1
		Ta= -40 to +85°C V _{DD} = 1.8 to 5.5V	Typ. -2.5%	32.768	Typ. +2.5%		
		Ta= -40 to +105°C V _{DD} = 1.8 to 5.5V	Typ. -3.0%	32.768	Typ. +3.0%		
		V _{DD} = 1.6 to 1.8V	Typ. -3.5%	32.768	Typ. -3.5%		
Low-speed RC oscillator frequency accuracy 2 With software adjustment	f _{RCL2}	Ta= -40 to +85°C V _{DD} = 1.8 to 5.5V	Typ. -1.0%	32.768	Typ. +1.0%		
		Ta= -40 to +105°C V _{DD} = 1.8 to 5.5V	Typ. -1.5%	32.768	Typ. +1.5%		
PLL oscillation frequency accuracy 1 Without software adjustment	f _{PLL1}	Ta= -40 to +85°C V _{DD} = 1.8 to 5.5V	Typ. -2.5%	16/24	Typ. +2.5%	MHz	
		Ta= -40 to +105°C V _{DD} = 1.8 to 5.5V	Typ. -3.0%	16/24	Typ. +3.0%		
		V _{DD} = 1.6 to 1.8V	Typ. -3.5%	16/24	Typ. +3.5%		
PLL oscillation frequency accuracy 2 With software adjustment	f _{PLL2}	Ta= -40 to +85°C V _{DD} = 1.8 to 5.5V	Typ. -1.0%	16/24	Typ. +1.0%		
		Ta= -40 to +105°C V _{DD} = 1.8 to 5.5V	Typ. -1.5%	16/24	Typ. +1.5%		
PLL oscillation start time	T _{PLL}	V _{DD} = 1.6 to 5.5V	—	—	2	ms	
1kHz Low-speed RC oscillator (for WDT) frequency accuracy	f _{RC1K}	Ta= -40 to +105°C V _{DD} = 1.6 to 5.5V	0.5	1	2.5	kHz	

Input / Output pin 1

(V_{DD}=1.6 to 5.5V, V_{SS}=0V, Ta=-40 to +105°C, unless otherwise specified)

Parameter	Symbol	Condition	Min.	Typ.	Max.	Unit	Measuring circuit	
Output voltage1 “H”/“L” level (P00-P07) (P10-P17) (P20-P27) (P30-P33) (P40-P47) (P50-P57) (P60-P67) (P70,P76,P77) (P80-P87) (P90-P97) (PA0-PA7) (PB0-PB7)	VOH1	IOH1=-10mA V _{DD} ≥4.5V	V _{DD} -1.5	—	—	V	2	
		IOH1=-1mA V _{DD} ≥1.6V	V _{DD} -0.5	—	—			
	VOL1	IOL1=+10mA V _{DD} ≥4.5V	—	—	1.5			
		IOL1=+1mA V _{DD} ≥1.6V	—	—	0.5			
Output voltage2 “L” level (P01-P07) (P10-P17) (P20-P27) (P30-P33) (P40-P47) (P50-P57) (P60-P67) (P70 P76,P77) (P80-P87) (P90-P97) (PA0-PA7) (PB0-PB7)	VOL2	When N-ch open drain output mode is selected	IOL2=+15mA V _{DD} ≥4.5V	—	—	0.5		
			IOL2=+8mA V _{DD} ≥3.0V	—	—	0.5		
			IOL2=+3mA V _{DD} ≥2.0V	—	—	0.4		
			IOL2=+2mA V _{DD} ≥1.6V	—	—	0.4		
Output voltage 3 LCD COM/SEG (COM0~COM7) (SEG0~SEG64)	VOH3M	V _{L3} = 3V, V _{L2} = 2V, V _{L1} = 1V	IOH3M=-0.03mA V _{L3} output	V _{L3} -0.2	—	V	2	
	VOH3P		IOMH3P=+0.03mA V _{L2} output	—	—			V _{L2} +0.2
	VOMH3M		IOMH3M=-0.03mA V _{L2} output	V _{L2} -0.2	—			—
	VOML3P		IOML3P=+0.03mA V _{L1} output	—	—			V _{L1} +0.2
	VOML3M		IOML3M=-0.03mA V _{L1} output	V _{L1} -0.2	—			—
	VOL3P		IOL3P=+0.03mA V _{SS} output	—	—			0.2

Input / Output pin 2

(V_{DD}=1.6 to 5.5V, V_{SS}=0V, Ta=-40 to +105°C, unless otherwise specified)

Parameter	Symbol	Condition	Min.	Typ.	Max.	Unit	Measu ring circuit	
“H” level output current1 *6	IOH1	1pin	V _{DD} ≥4.5V	-10*3*5	—	—	mA	
			V _{DD} ≥1.6V	-1*3*5	—	—		
“H” level output current1 *1*4	IOH3	Total of ‘P00-P07, P10-P13, P44-P47, P50-P53, P70,P76, P80-P87, P90-P97, PA0’ or Total of ‘P14-P17, P20-P27, P30-P33, P40-P43, P54-P57 P60-P67,P77, PA1-PA7, PB0-PB7’ (duty≤50%)	V _{DD} ≥4.5V	-90*5	—	—		
			V _{DD} ≥1.6V	-20*5	—	—		
		All pin total (duty≤50%)	V _{DD} ≥4.5V	-180*5	—	—		
“L” level output current1 *6	IOL1	1pin (CMOS output mode)	V _{DD} ≥4.5V	—	—	10*3		
			V _{DD} ≥1.6V	—	—	1*3		
“L” level output current2 *6	IOL2	1pin (N-ch open drain output mode)	V _{DD} ≥4.5V	—	—	15*3		
			V _{DD} ≥3.0V	—	—	8*3		
			V _{DD} ≥2.0V	—	—	3*3		
			V _{DD} ≥1.6V	—	—	2*3		
“L” level output total current *2*4	IOL3	Total of P00-P07, P10-P13, P44-P47, P50-P53, P70,P76, P80-P87, P90-P97, PA0’ or Total of ‘P14-P17, P20-P27, P30-P33, P40-P43, P54-P57 P60-P67,P77, PA1-PA7, PB0-PB7’ (N-ch open drain output mode,duty≤50%)	V _{DD} ≥4.5V	—	—	90		
			V _{DD} ≥3.0V	—	—	40		
		All pin total (N-ch open drain output mode,duty≤50%)	V _{DD} ≥2.0V	—	—	15		
			V _{DD} ≥1.6V	—	—	10		
		Output leak (P00-P07) (P10-P17) (P20-P27) (P30-P33) (P40-P47) (P50-P57) (P60-P67) (P70,P76,P77) (P80-P87) (P90-P97) (PA0-PA7) (PB0-PB7)	IOOH	VOH=V _{DD} (High impedance mode)	—	—	+1	μA
					IOOL	VOL=V _{SS} (High impedance mode)	-1*5	

3

- *¹ Sink-out current from V_{DD} to the output pin, which can guarantee the device operation.
- *² Sink-in current from the output pin to V_{SS} , which can guarantee the device operation.
- *³ Do not exceed total current.
- *⁴ The total current is on the condition of Duty \leq 50%(same applies to IOH1).
When the duty $>$ 50% the total current is calculated by following formula.
Total current = IOL3 x 50/n (When the duty is n%)
<For an example> When IOL3=100mA and n=80%,
Total current = IOL3 x 50/80 = 62.5mA
Current allowed per 1pin is independent of the duty and specified as IOL1 and IOL2.
Do not apply current larger than Absolute Maximum Ratings.
- *⁵ The current flowing out the LSI through the pin is described in the negative number.
The applicable maximum current is the absolute value.
For example, -1mA means the maximum current 1mA flows out the LSI through the pin.
- *⁶ These values are satisfied with VOH1, VOL1 and VOL2.

Input / Output pin 3

(V_{DD}=1.6 to 5.5V, V_{SS}=0V, Ta=-40 to +105°C, unless otherwise specified)

Parameter	Symbol	Condition	Min.	Typ.	Max.	Unit	Measuring circuit
Input current1 (RESET_N)	I _{IH1}	V _{IH1} =V _{DD}	—	—	1	μA	4
	I _{IL1}	V _{IL1} =V _{SS}	-1* ¹	—	—		
Input current2 (P00/TEST0)	I _{IL2}	V _{IL2} =V _{SS} (pull-up mode) * ²	-1500* ¹	-300* ¹	-20* ¹	kΩ	
	V/I _{IL2}	V _{IL2} =V _{SS} (pull-up mode) * ²	3.7	10	80	μA	
	I _{IH2Z}	V _{IH2} =V _{DD} (High impedance mode)	—	—	1		
Input current3 (P01-P07) (P10-P17) (P20-P27) (P30-P33) (P40-P47) (P50-P57) (P60-P67) (P70,P76,P77) (P80-P87) (P90-P97) (PA0-PA7) (PB0-PB7)	I _{IL2Z}	V _{IL2} =V _{SS} (High impedance mode)	-1* ¹	—	—	μA	
	I _{IL3}	V _{IL1} =V _{SS} (pull-up mode) * ²	-250* ¹	-30* ¹	-2* ¹		
	V/I _{IL3}	V _{IL1} =V _{SS} (pull-up mode) * ²	22	100	800		
	I _{IH3Z}	V _{IH1} =V _{DD} (High impedance mode)	—	—	1	μA	
	I _{IL3Z}	V _{IL1} =V _{SS} (High impedance mode)	-1* ¹	—	—		
Input current4 (PI00-PI01)	I _{IH4}	V _{IH1} =V _{DD}	—	—	1	μA	
	I _{IL4}	V _{IL1} =V _{SS}	-1* ¹	—	—		
Input voltage1 (RESET_N) (P01-P07) (P10-P17) (P20-P27) (P30-P33) (P40-P47) (P50-P57) (P60-P67) (P70,P76,P77) (P80-P87) (P90-P97) (PA0-PA7) (PB0-PB7) (PI00-PI01)	V _{IH1}	—	0.7 x V _{DD}	—	V _{DD}	V	5
	V _{IL1}	—	0	—	0.3 x V _{DD}		
Input voltage2 (P00/TEST0)	V _{IH2}	—	0.7 x V _{DD}	—	V _{DD}	μA	
	V _{IL2}	—	0	—	0.25 x V _{DD}		
Pin capacitance (RESET_N) (P00/TEST0) (P01-P07) (P10-P17) (P20-P27) (P30-P33) (P40-P47) (P50-P57) (P60-P67) (P70,P76,P77) (P80-P87) (P90-P97) (PA0-PA7) (PB0-PB7) (PI00-PI01)	C _{PIN}	f = 10kHz Ta = +25°C	—	—	10	pF	—

*¹ The current flowing out the LSI through the pin is described in the negative number. The applicable maximum current is the absolute value. For example, -1mA means the maximum current 1mA flows out the LSI through the pin.

*² Measurement conditions: Typ. : V_{DD} = 3.0V, Max. : V_{DD} = 1.6V, Min. : V_{DD} = 5.5V

Synchronous Serial Port

Slave mode

($V_{DD}=1.8$ to $5.5V$, $V_{SS}=0V$, $T_a=-40$ to $+105^{\circ}C$, unless otherwise specified)

Parameter	Symbol	Condition	Min.	Typ.	Max.	Unit
SCK input cycle	t_{SCYC}	—	1 ^{*2}	—	—	μs
SCK input pulse width	t_{SW}	—	0.5 ^{*3}	—	—	μs
SOUT output delay time	t_{SD}	$V_{DD}=2.4$ to $5.5V$	—	—	100+ HCLK ^{*1} $\times 3$	ns
		$V_{DD}=1.8$ to $5.5V$	—	—	200+ HCLK ^{*1} $\times 3$	ns
SIN input setup time	t_{SS}	—	HCLK ^{*1} $\times 1$	—	—	ns
SIN input hold time	t_{SH}	—	80+ HCLK ^{*1} $\times 3$	—	—	ns

*1 Cycle of high speed clock

*2 Need input cycles of HSLCK x8 or longer

*3 Need input cycles of HSLCK x4 or longer

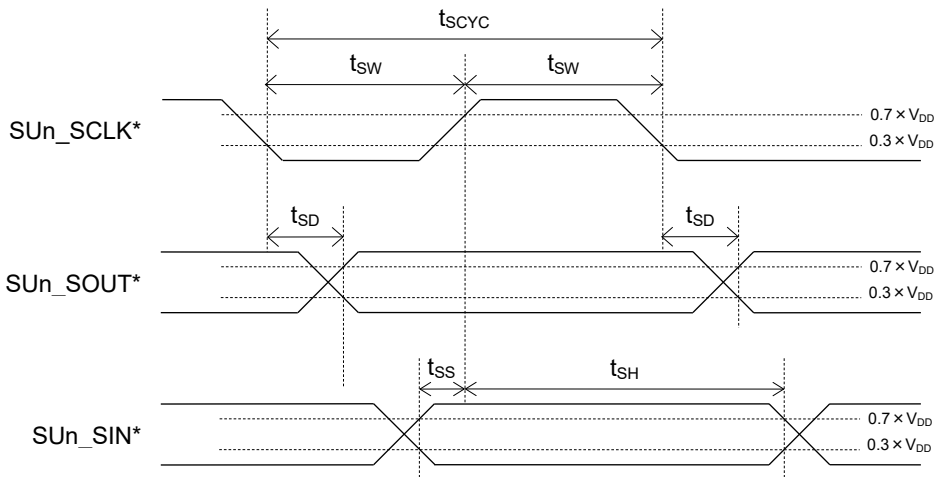

* 2nd to 8th function of port, n=0~5

Master mode

($V_{DD}=1.8$ to $5.5V$, $V_{SS}=0V$, $T_a=-40$ to $+105^{\circ}C$, unless otherwise specified)

Parameter	Symbol	Condition	Min.	Typ.	Max.	Unit
SCK output cycle	t_{SCYC}	—	—	$SCLK^{*1}$	—	ns
SCK output pulse width	t_{SW}	—	$SCLK^{*1} \times 0.4$	$SCLK^{*1} \times 0.5$	$SCLK^{*1} \times 0.6$	ns
SOUT output delay time	t_{SD}	$V_{DD}=2.4$ to $5.5V$	—	—	100	ns
		$V_{DD}=1.8$ to $5.5V$	—	—	160	ns
SIN input setup time	t_{SS}	$V_{DD}=2.4$ to $5.5V$	120	—	—	ns
		$V_{DD}=1.8$ to $5.5V$	180	—	—	ns
SIN input hold time	t_{SH}	$V_{DD}=2.4$ to $5.5V$	80	—	—	ns
		$V_{DD}=1.8$ to $5.5V$	100	—	—	ns

*1 Clock cycle selected by bit12~8(SnCK4~0) of the serial port n mode register (SIOOnMOD)
 $V_{DD} \geq 2.4V$: min250ns, $V_{DD} \geq 1.8V$: min500ns

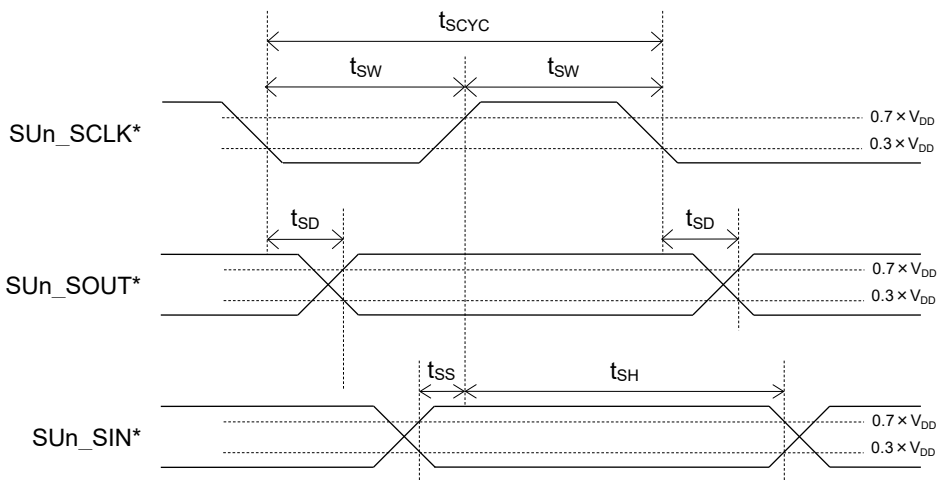

* 2nd to 8th function of port, n=0~5

I²C Bus Interface

Standard Mode (100k bit/s)

(V_{DD}=1.8 to 5.5V, V_{SS}=0V, Ta=-40 to +105°C, unless otherwise specified)

Parameter	Symbol	Condition	Min.	Typ.	Max.	Unit
SCL clock frequency	f _{SCL}	—	0	—	100	kHz
SCL hold time (start/restart condition)	t _{HD:STA}	—	4.0	—	—	μs
SCL "L" level time	t _{LOW}	—	4.7	—	—	μs
SCL "H" level time	t _{HIGH}	—	4.0	—	—	μs
SCL setup time (restart condition)	t _{SU:STA}	—	4.7	—	—	μs
SDA hold time	t _{HD:DAT}	—	0	—	—	μs
SDA setup time	t _{SU:DAT}	—	0.25	—	—	μs
SDA setup time (stop condition)	t _{SU:STO}	—	4.0	—	—	μs
Bus-free time	t _{BUF}	—	4.7	—	—	μs

When using the I²C as the master, configure the I²C master n mode register(I2MnMOD) and I²C bus 0 mode register (master side, I2UM0MOD) so that meet these specifications.

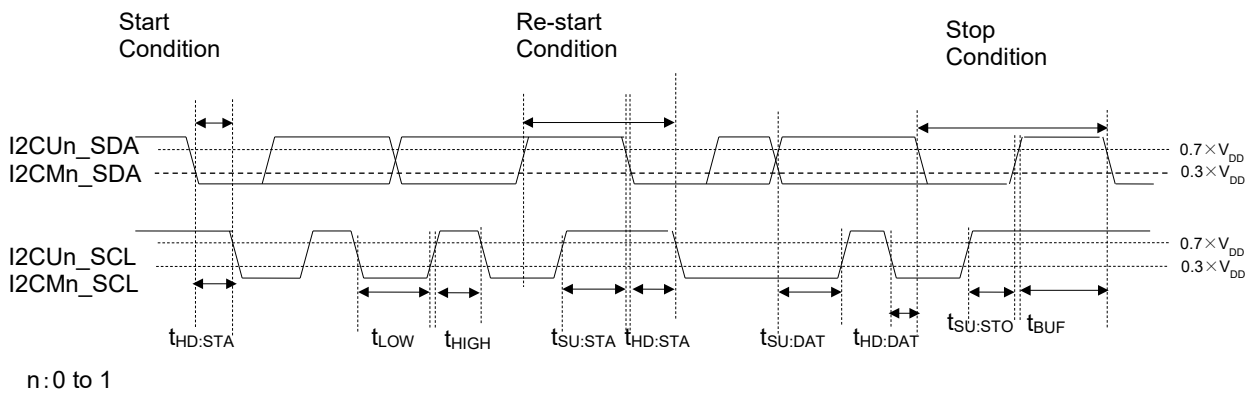

Fast Mode (400k bit/s)

($V_{DD}=1.8$ to $5.5V$, $V_{SS}=0V$, $T_a=-40$ to $+105^{\circ}C$, unless otherwise specified)

Parameter	Symbol	Condition	Min.	Typ.	Max.	Unit
SCL clock frequency	f_{SCL}	—	0	—	400	kHz
SCL hold time (start/restart condition)	$t_{HD:STA}$	—	0.6	—	—	μs
SCL "L" level time	t_{LOW}	—	1.3	—	—	μs
SCL "H" level time	t_{HIGH}	—	0.6	—	—	μs
SCL setup time (restart condition)	$t_{SU:STA}$	—	0.6	—	—	μs
SDA hold time	$t_{HD:DAT}$	—	0	—	—	μs
SDA setup time	$t_{SU:DAT}$	—	0.1	—	—	μs
SDA setup time (stop condition)	$t_{SU:STO}$	—	0.6	—	—	μs
Bus-free time	t_{BUF}	—	1.3	—	—	μs

When using the I²C as the master, configure the I²C master n mode register(I2MnMOD) and I²C bus 0 mode register (master side, I2UM0MOD) so that meet these specifications.

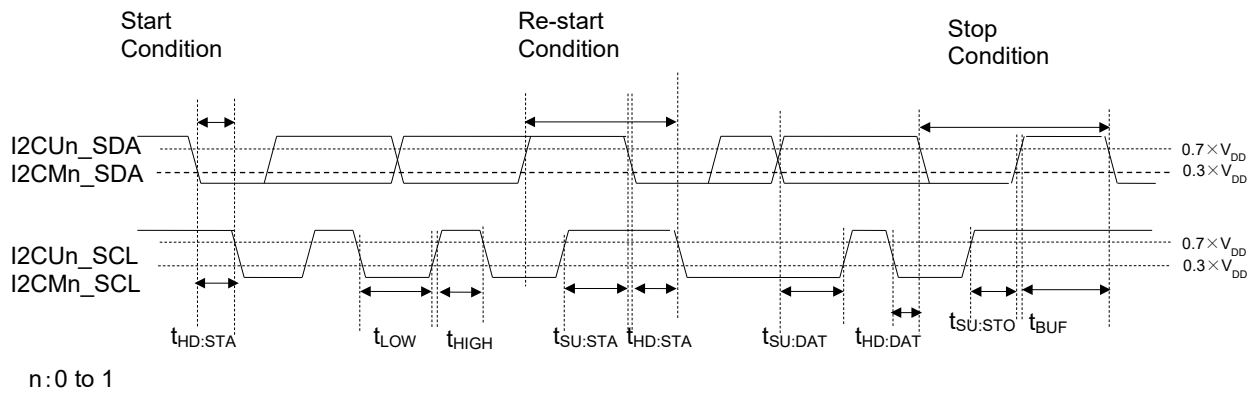

1Mbps Mode (1M bit/s)

($V_{DD}=2.7$ to $5.5V$, $V_{SS}=0V$, $T_a=-40$ to $+105^{\circ}C$, unless otherwise specified)

Parameter	Symbol	Condition	Min.	Typ.	Max.	Unit
SCL clock frequency	f_{SCL}	—	0	—	1000	kHz
SCL hold time (start/restart condition)	$t_{HD:STA}$	—	0.26	—	—	μs
SCL "L" level time	t_{LOW}	—	0.5	—	—	μs
SCL "H" level time	t_{HIGH}	—	0.26	—	—	μs
SCL setup time (restart condition)	$t_{SU:STA}$	—	0.26	—	—	μs
SDA hold time	$t_{HD:DAT}$	—	0	—	—	μs
SDA setup time	$t_{SU:DAT}$	—	0.1	—	—	μs
SDA setup time (stop condition)	$t_{SU:STO}$	—	0.26	—	—	μs
Bus-free time	t_{BUF}	—	0.5	—	—	μs

When using the I²C as the master, configure the I²C master n mode register(I2MnMOD) and I²C bus 0 mode register (master side, I2UM0MOD) so that meet these specifications.

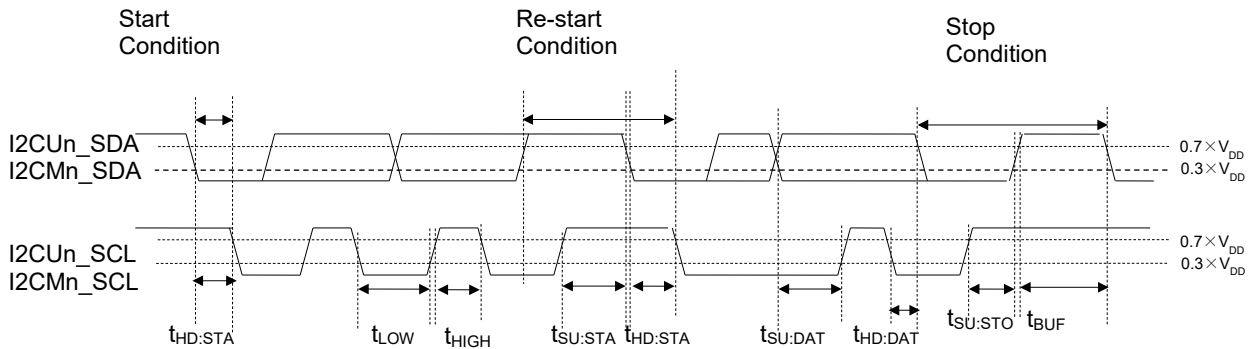

n:0 to 1

Reset

($V_{DD}=1.6$ to $5.5V$, $V_{SS}=0V$, $T_a=-40$ to $+105^{\circ}C$, unless otherwise specified)

Parameter	Symbol	Condition	Min.	Typ.	Max.	Unit	Measuring circuit
Reset pulse width	P_{RST}	—	2	—	—	ms	1
P00 "H" level setup time	t_{SP00}	—	1	—	—	ms	
P00 "H" level hold time ^{*1}	t_{HP00}^{*1}	—	1	—	—	ms	

^{*1}: except ISP mode. Refer to the User's manual "25.4 In-System Programming Function" for the timing in ISP mode.

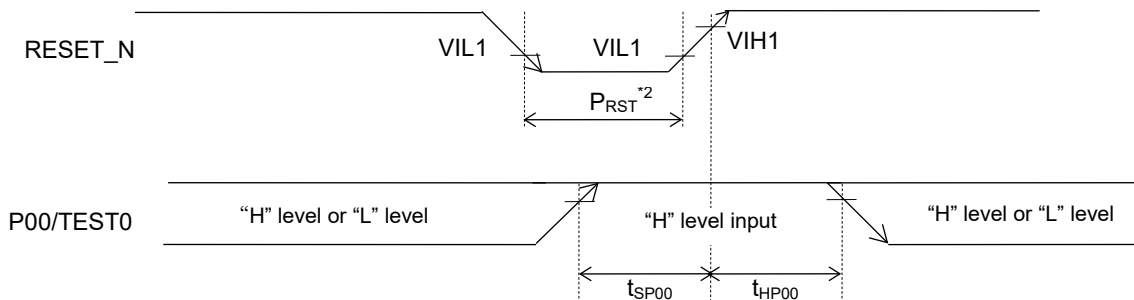

^{*2}: $V_{DD}=1.6V$ or over at power on.

Note:

- RESET_N input shorter pulse than the Reset pulse width (P_{RST}) valid time should be avoided. The shorter pulse input may cause unexpected behavior.

Slope of Power supply and Power On Reset

($V_{SS} = 0V$, $T_a = -40$ to $+105^\circ C$, unless otherwise specified)

Parameter	Symbol	Condition	Min.	Typ.	Max.	Unit	Measuring circuit
Power on rising slope	S_{VR}	—	—	—	60	V/ms	1
Power on falling slope	S_{VF}	—	—	—	2	V/ms	
Power on reset detection voltage	V_{PORR}	At Power up (rising)	1.47	1.57	1.80	V	
	V_{PORF}	At Power down (falling)	1.33	1.49	1.58	V	
Power on reset minimum pulse width	P_{POR}	—	200	—	—	μs	
Power on voltage	V_{INIT}	At power on	1.8	—	—	V	
CPU operation start time (from the release of reset to the CPU starts to run)	t_{CPU}	—	11	16	—	ms	—

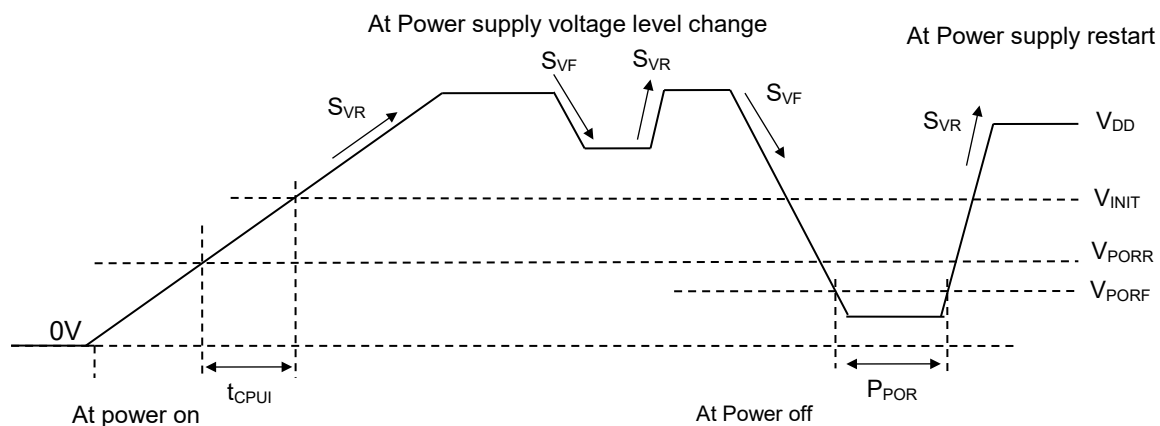

- Note:
- If a pulse shorter than the Power on reset minimum pulse width is asserted to V_{DD} , it may cause the MCU malfunction. Apply prevent measurement such as bypass capacitors or external reset input, and so on.
 - Start the high-speed clock when the V_{DD} is within the operating voltage.

VLS

(V_{DD}=1.6 to 5.5V, V_{SS}=0V, Ta=-40 to +105°C, unless otherwise specified)

Parameter	Symbol	Condition		Min.	Typ.	Max.	Unit	Measuring circuit
		VLS0LV * ¹						
VLS threshold voltage * ²	V _{VLSR}	00H	Rising	3.86	4.06	4.26	V	1
	V _{VLSF}		Falling	3.84	4.00	4.16		
	V _{VLSR}	01H	Rising	3.57	3.76	3.95		
	V _{VLSF}		Falling	3.55	3.70	3.85		
	V _{VLSR}	02H	Rising	2.94	3.11	3.28		
	V _{VLSF}		Falling	2.92	3.05	3.18		
	V _{VLSR}	03H	Rising	2.85	3.01	3.17		
	V _{VLSF}		Falling	2.83	2.95	3.07		
	V _{VLSR}	04H	Rising	2.75	2.91	3.07		
	V _{VLSF}		Falling	2.73	2.85	2.97		
	V _{VLSR}	05H	Rising	2.66	2.81	2.96		
	V _{VLSF}		Falling	2.64	2.75	2.86		
	V _{VLSR}	06H	Rising	2.56	2.71	2.86		
	V _{VLSF}		Falling	2.54	2.65	2.76		
	V _{VLSR}	07H	Rising	2.46	2.61	2.76		
	V _{VLSF}		Falling	2.44	2.55	2.66		
	V _{VLSR}	08H	Rising	2.37	2.51	2.65		
	V _{VLSF}		Falling	2.35	2.45	2.55		
	V _{VLSR}	09H	Rising	1.98	2.11	2.24		
	V _{VLSF}		Falling	1.96	2.05	2.14		
V _{VLSR}	0AH	Rising	1.89	2.01	2.13			
V _{VLSF}		Falling	1.87	1.95	2.03			
V _{VLSR}	0BH	Rising	1.79	1.91	2.03			
V _{VLSF}		Falling	1.77	1.85	1.93			
VLS Current	I _{VLS}	—		—	50	—	nA	

*¹ Bit3~Bit0 of voltage level detection circuit 0 level register (VLS0LV).*² The Data VLS0LV = 0CH~0FH is not available to use, if the data is specified it will the same spec as that 0BH is specified.

Analog Comparator

(V_{DD}=1.8 to 5.5V, V_{SS}=0V, Ta=-40 to +105°C, unless otherwise specified)

Parameter	Symbol	Condition	Min.	Typ.	Max.	Unit	Measuring circuit
Comparator same phase input voltage range	V _{CMR}	—	0.1	—	V _{DD} -1.5	V	1
Comparator0 input offset	V _{CMOF}	Ta=+25°C, V _{DD} =5.0V	—	5	—	mV	
Comparator Reference Voltage	V _{CMREF}	—	0.75	0.8	0.85	V	

Successive Approximation Type A/D Converter

($V_{DD}=1.8$ to $5.5V$, $V_{SS}=0V$, $T_a=-40$ to $+105^{\circ}C$, unless otherwise specified)

Parameter	Symbol	Condition	Min.	Typ.	Max.	Unit
Resolution	n_{AD}	—	—	—	10	bit
Overall error	—	$4.5V \leq \text{Reference voltage}^{*1} \leq 5.5V$	-3.5	1.2	3.5	LSB
Integral non-linearity error	INL_{AD}	$2.7V \leq \text{Reference voltage}^{*1} \leq 5.5V$	-4	—	4	
		$2.2V \leq \text{Reference voltage}^{*1} < 2.7V$	-6	—	6	
		$1.8V \leq \text{Reference voltage}^{*1} < 2.2V$	-10	—	10	
		Reference voltage = Internal reference voltage	-15	—	15	
Differential non-linearity error	DNL_{AD}	$2.7V \leq \text{Reference voltage}^{*1} \leq 5.5V$	-3	—	3	
		$2.2V \leq \text{Reference voltage}^{*1} < 2.7V$	-5	—	5	
		$1.8V \leq \text{Reference voltage}^{*1} < 2.2V$	-9	—	9	
		Reference voltage = Internal reference voltage	-14	—	14	
Zero-scale error	ZSE	$R_I \leq 1k\Omega$	-6	—	6	
Full-scale error	FSE	$R_I \leq 1k\Omega$	-6	—	6	
A/D reference voltage	V_{REF}	—	1.8	—	V_{DD}	V
Internal reference voltage	V_{REFI}	—	1.5	1.55	1.6	
Conversion time	t_{CONV}	$4.5V \leq V_{DD} \leq 5.5V$	2.25	—	427	μs
		$2.2V \leq V_{DD} \leq 5.5V$	4.5	—	427	
		$1.8V \leq V_{DD} \leq 5.5V$	18	—	427	

*1 : V_{DD} or P23/ V_{REF} is selected for the reference voltage of Successive Approximation Type A/D Converter by setting bit5(V_{REFP1}) and bit4(V_{REFP0}) of Reference voltage control register (V_{REFCON}).

The current flows during the ADC sampling as it takes charging. Make the output impedance of the analog signal source $1k\Omega$ or smaller. Also, putting $0.1\mu F$ capacitor on the ADC input pin is recommended to reduce the noise.

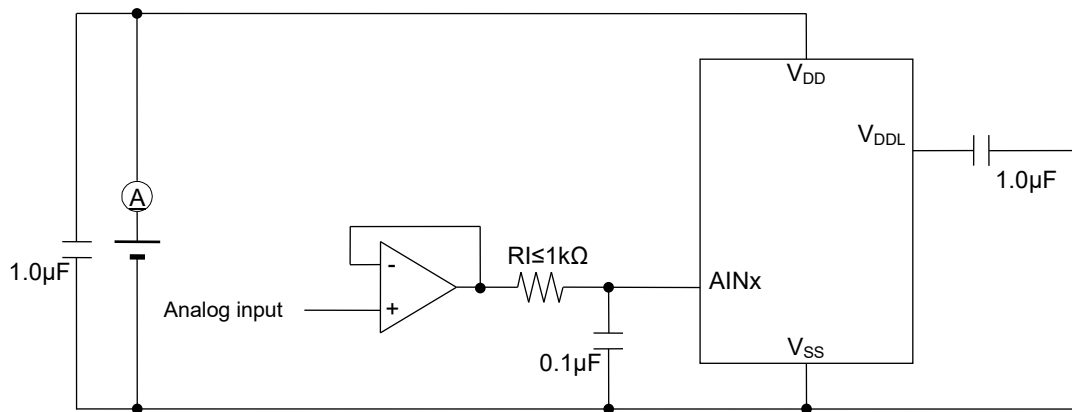

D/A Converter

(V_{DD}=1.8 to 5.5V, V_{SS}=0V, Ta=-40 to +105°C, unless otherwise specified)

Parameter	Symbol	Condition	Min.	Typ.	Max.	Unit
Resolution	n _{DA}	—	—	—	8	bit
Conversion cycle	tc	—	10	—	—	μs
Integral non-linearity error	INL _{DA}	RL=4MΩ	-2	—	2	LSB
Differential non-linearity error	DNL _{DA}	RL=4MΩ	-1	—	1	
Output impedance	R _o	DACEN bit of D/A converter enable register =1	3	6	9	kΩ

Reference Voltage Output

(V_{DD}=1.8 to 5.5V, V_{SS}=0V, Ta=-40 to +105°C, unless otherwise specified)

Parameter	Symbol	Condition	Min.	Typ.	Max.	Unit
Output voltage	V _{REFO}	—	—	1.55	—	V
Output impedance	R _{VREFO}	—	—	—	500	kΩ

Flash Memory

(V_{SS}= 0V)

Parameter	Symbol	Condition	Range	Unit	
Operating temperature	T _{OP}	Data flash memory, At write/erase	-40 to +85	°C	
		Flash ROM, At write/erase	0 to +40		
Operating voltage	V _{DD}	At write/erase	+1.8 to +5.5	V	
Maximum rewrite count	CEPD	Data Flash	10000	times	
	CEPP	Program Flash	100		
Erase unit	—	Block erase	Program Flash	16K	B
			Data Flash	all area	
	—	Sector erase	Program Flash	1K	B
			Data Flash	128	
Erase time (Max.)	—	Block erase / Sector erase	50	ms	
Write unit	—	Program Flash	4	B	
		Data Flash	1		
Write time (Max.)	—	Program Flash	80	μs	
	—	Data Flash	40		
Data retention period	YDR	—	15	years	

LCD Driver

($V_{DD}=1.8$ to $5.5V$, $V_{SS}=0V$, $T_a=-40$ to $+105^{\circ}C$, unless otherwise specified)

Parameter	Symbol	Condition	Range			Unit	Measuring circuit
			LCN ^{*1}	Min.	Typ.		
V _{L1} Voltage	V _{L1}	T _a =+25°C C _{L1,L2,L3} =1.0μF	00H	Typ. -0.05	0.950	Typ. +0.05	V
			01H		0.975		
			02H		1.000		
			03H		1.025		
			04H		1.050		
			05H		1.075		
			06H		1.100		
			07H		1.125		
			08H		1.150		
			09H		1.175		
			0AH		1.200		
			0BH		1.225		
			0CH		1.250		
			0DH		1.275		
			0EH		1.300		
			0FH		1.325		
			10H		1.350		
			11H		1.375		
			12H		1.400		
			13H		1.425		
14H	1.450						
15H	1.475						
16H	1.500						
17H	1.525						
18H	1.550						
19H	1.575						
1AH	1.600						
1BH	1.625						
1CH	1.650						
1DH	1.675						
1EH	1.700						
1FH	1.725						
V _{L2} Voltage	V _{L2}	T _a =+25°C C _{L1,C2,C3} =1.0μF C ₁₂ =1.0μF	V _{L1} x 1.8	V _{L1} x 2	—	V	
V _{L3} Voltage	V _{L3}		V _{L1} x 2.7	V _{L1} x 3	—		
Bias generation circuit start-up time	t _{BIAS}		—	—	200	ms	

6

*1: Value in LCN4~LCN0 bits of bias control register (BIASCON)

Measuring circuit
Measuring circuit 1

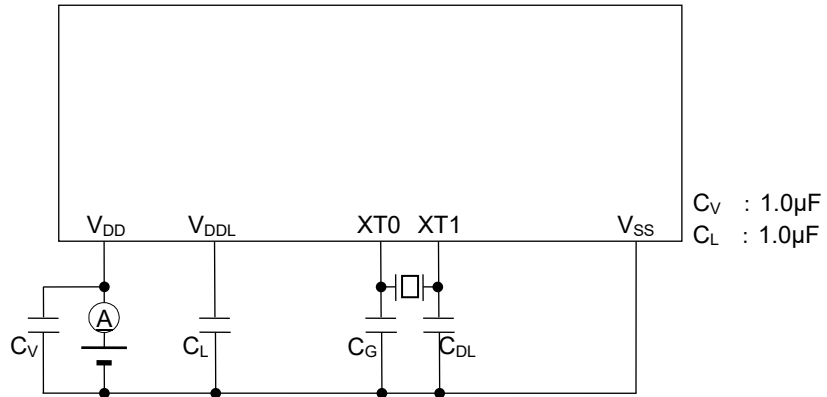

Measuring circuit 2

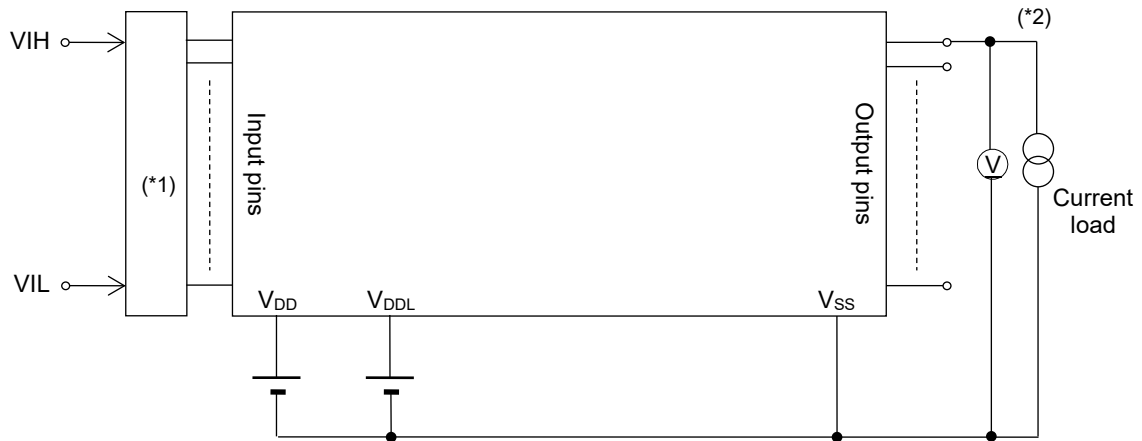

(*1) Input logic circuit to determine the specified measuring conditions
 (*2) Measured connecting specified pins

Measuring circuit 3

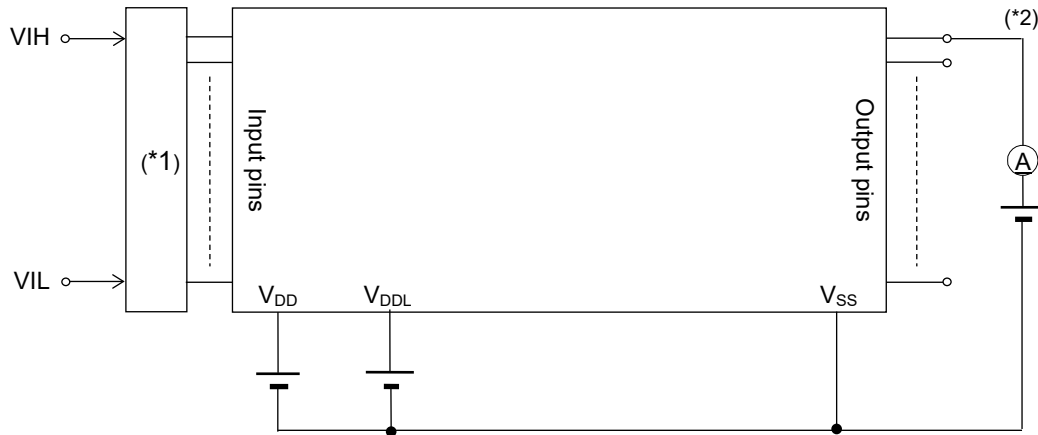

(*1) Input logic circuit to determine the specified measuring conditions
 (*2) Measured connecting specified pins

Measuring circuit 4

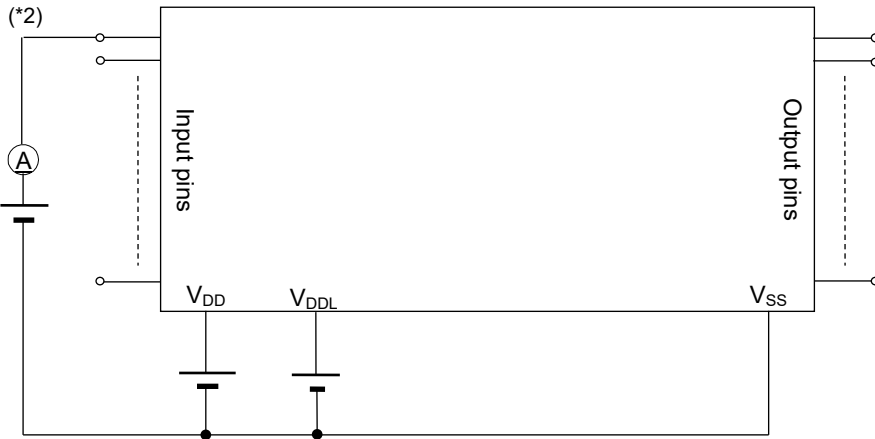

$(*2)$ Measured connecting specified pins

Measuring circuit 5

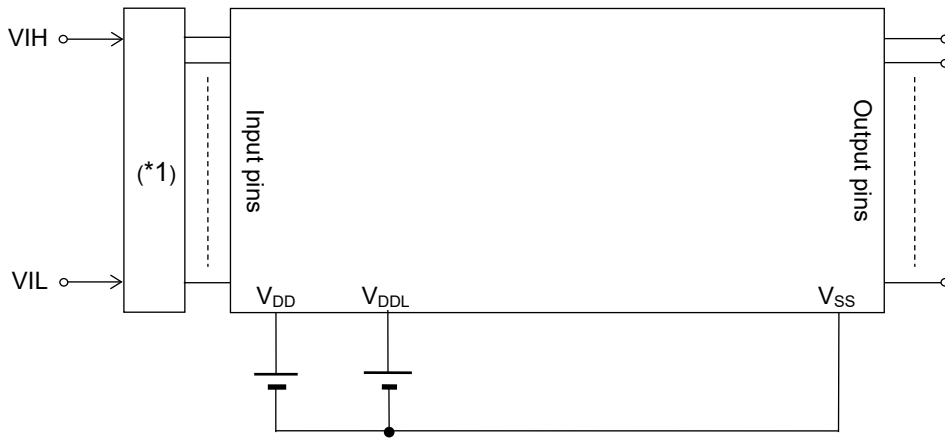

$(*1)$ Input logic circuit to determine the specified measuring conditions

Measuring circuit 6

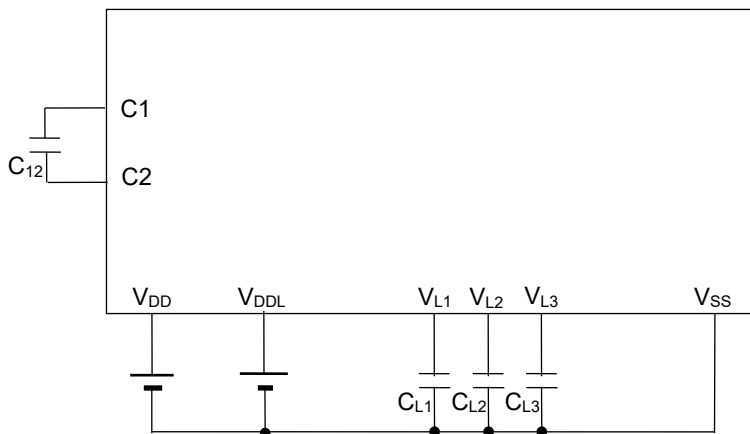

Characteristics graphs

These Graphs on the following pages are references for designing an application.

IOH vs V_{DD}-VOH1 (V_{DD}=5V TYP.)

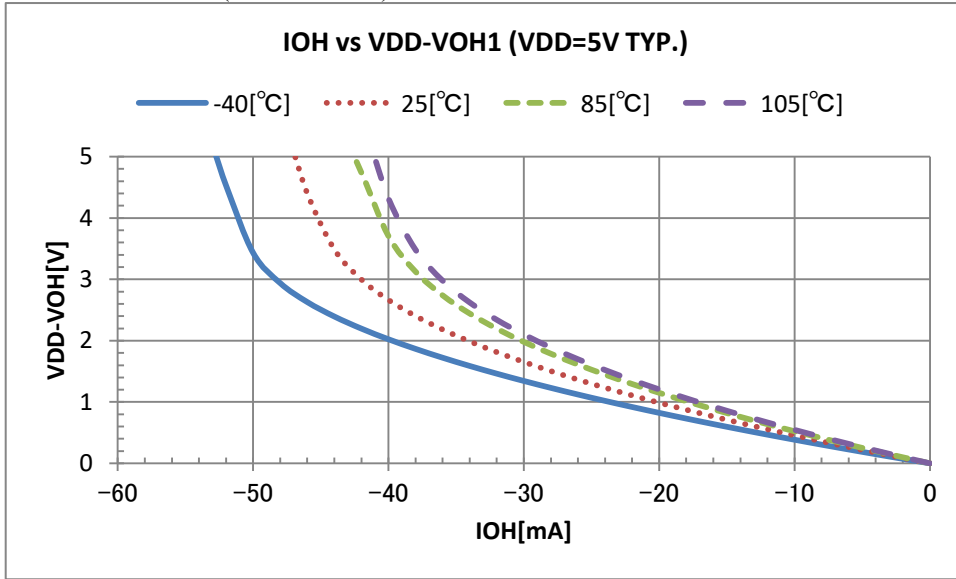

IOH vs V_{DD}-VOH1 (V_{DD}=3V TYP.)

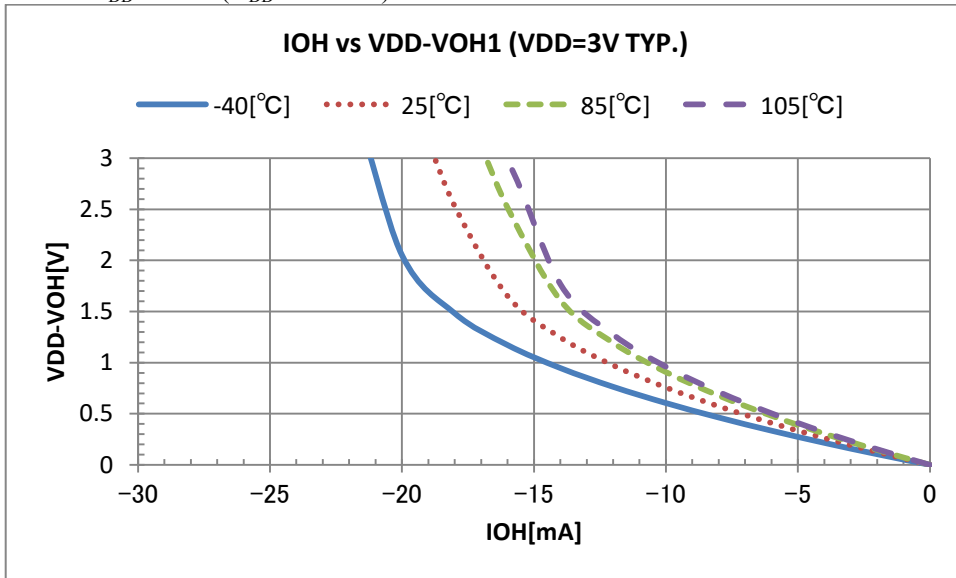

IOL vs VOL1 (V_{DD}=5V TYP.)

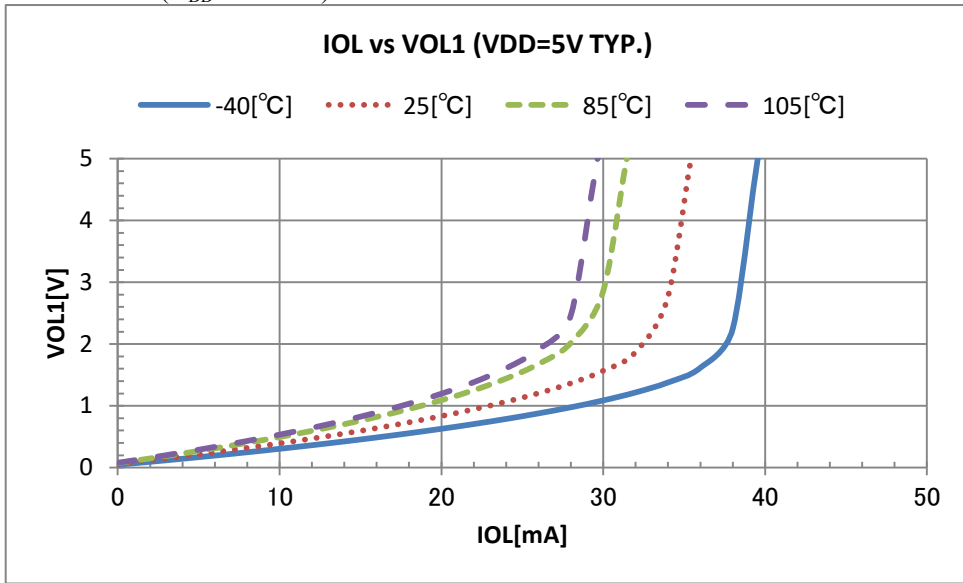

IOL vs VOL1 (V_{DD}=3V TYP.)

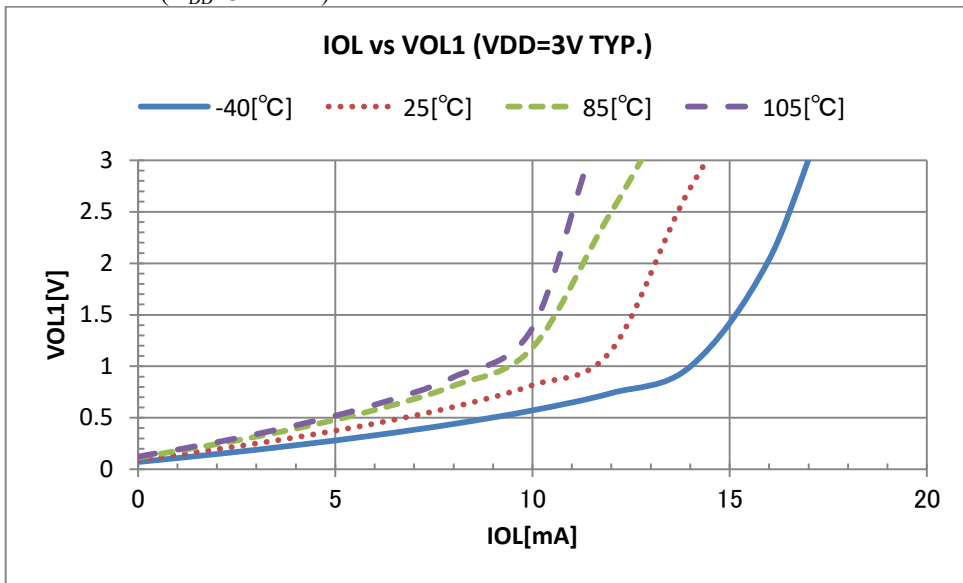

IOL vs VOL2 (V_{DD}=5V TYP.)

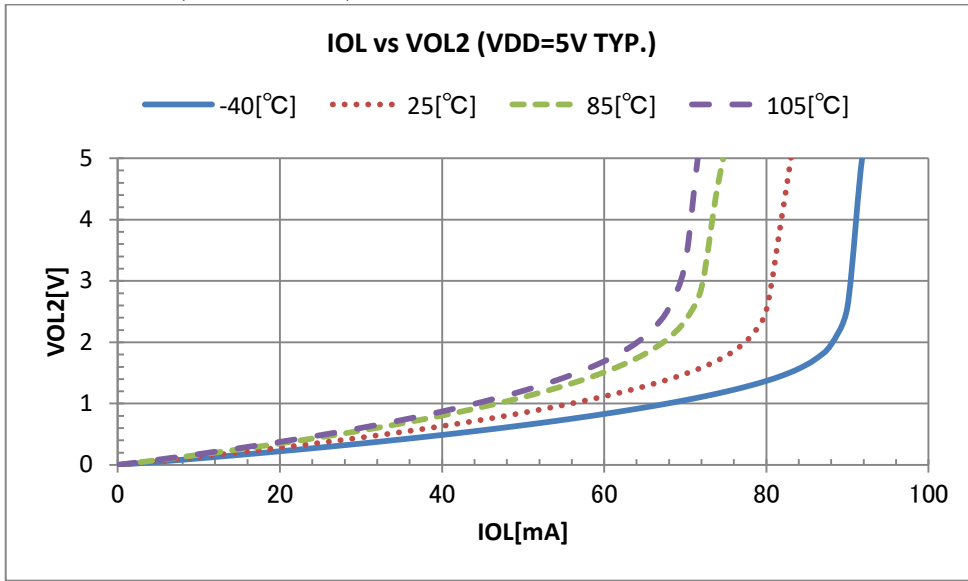

IOL vs VOL2 (V_{DD}=3V TYP.)

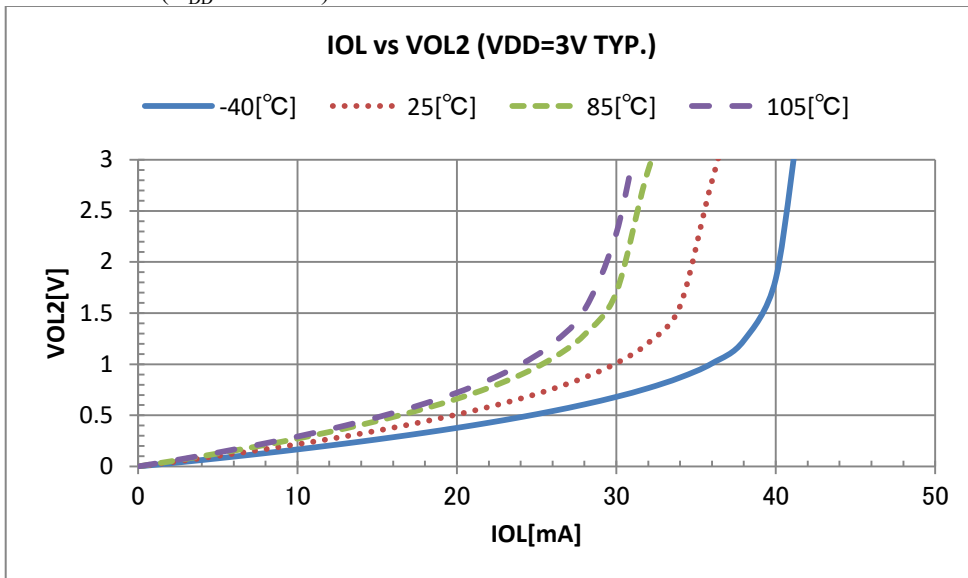

V_{DD} VS I_{IH2} (TYP. V_{IL2}=V_{SS})

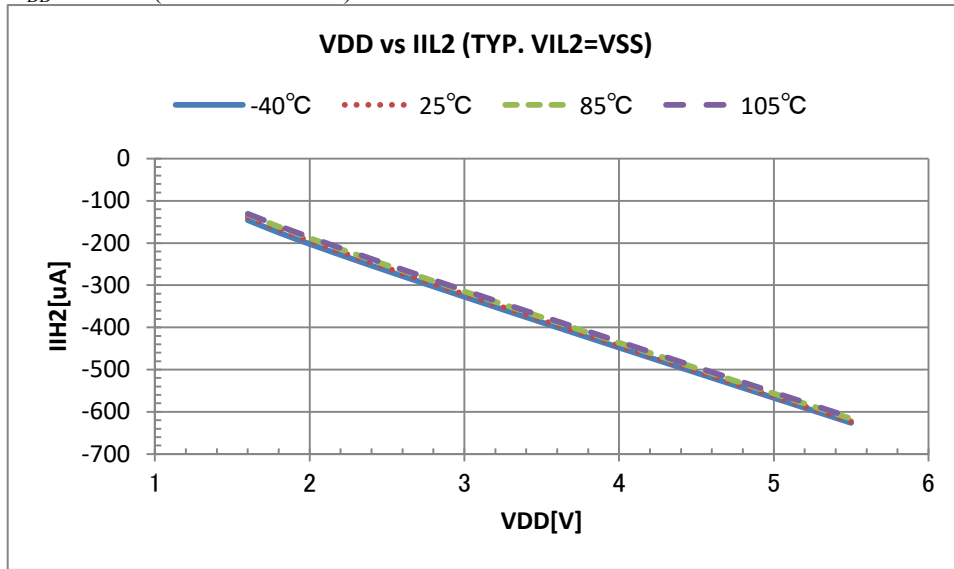

Pull-up resistor

V_{DD} VS V_{DD}/I_{IH2} (TYP. V_{IL2}=V_{SS})

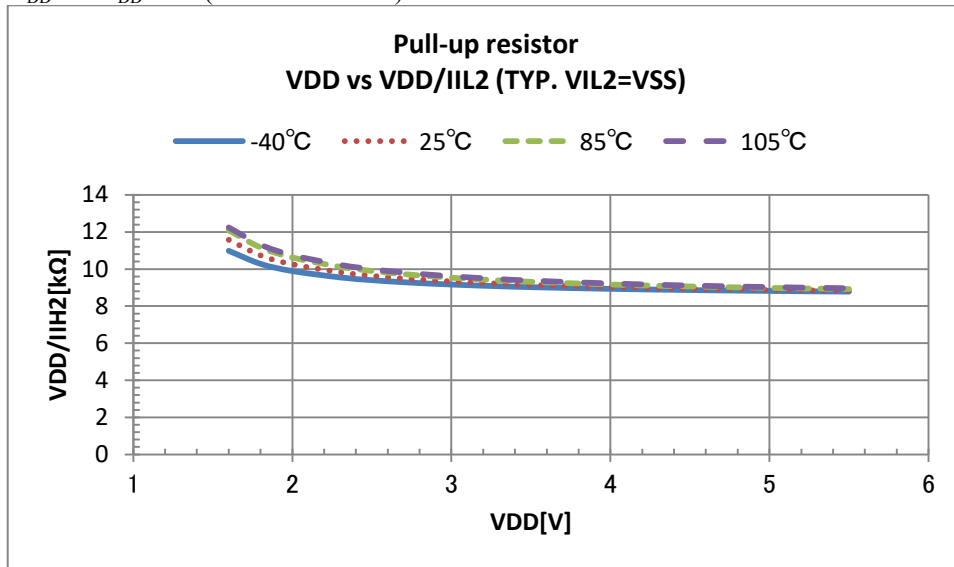

V_{DD} VS I_{IH3} (TYP. VIL3=VSS)

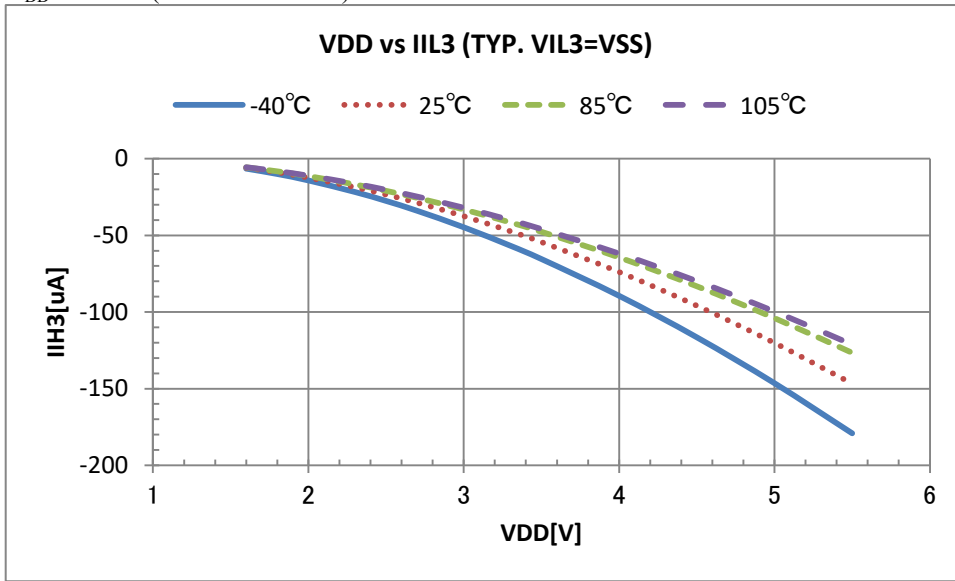

Pull-up resistor

V_{DD} VS V_{DD}/I_{IH3} (TYP. VIL3=VSS)

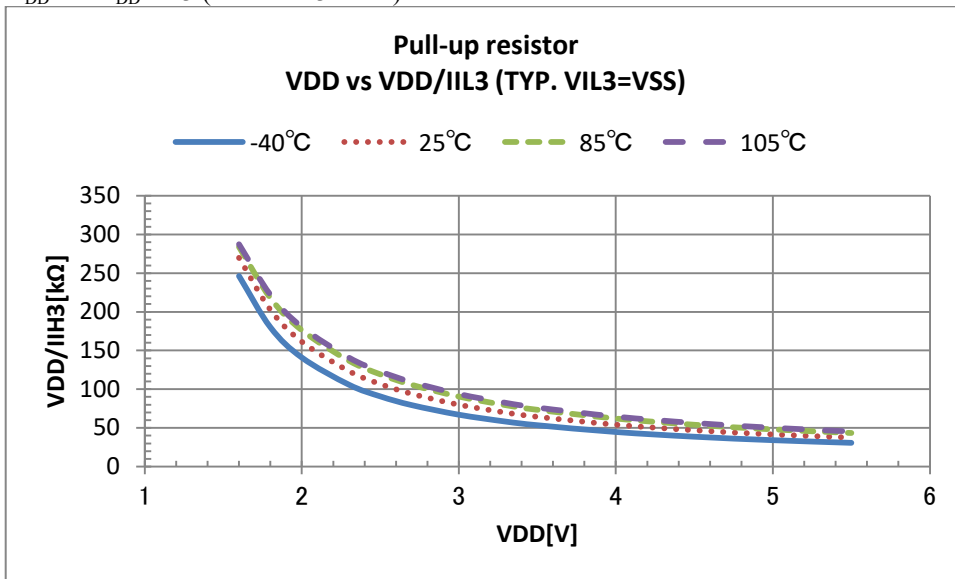

LAPIS Semiconductor Co.,Ltd.

Product: ML62Q1700, ML62Q1701, ML62Q1702, ML62Q1703, ML62Q1704, ML62Q1710, ML62Q1711, ML62Q1712, ML62Q1713, ML62Q1714, ML62Q1720, ML62Q1721, ML62Q1722, ML62Q1723, ML62Q1724

Current consumption VS operating frequency of CPU
 $V_{DD}=3V$, temp= $25^{\circ}C$ CPU 16MHz Wait mode (TYP.)
Stop the clock supply to peripherals.

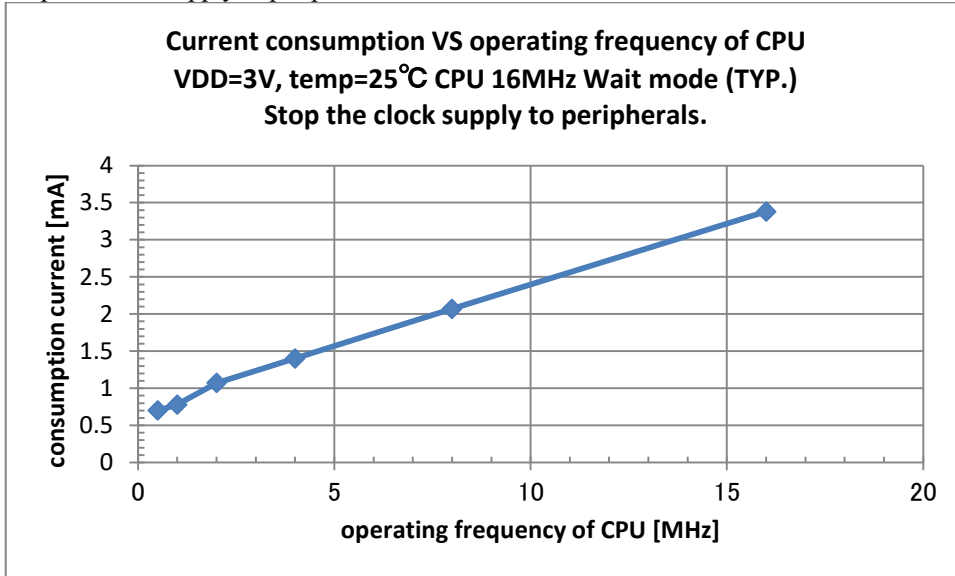

$V_{DD}=3V$, temp= $25^{\circ}C$ CPU 16MHz no Wait mode (TYP.)

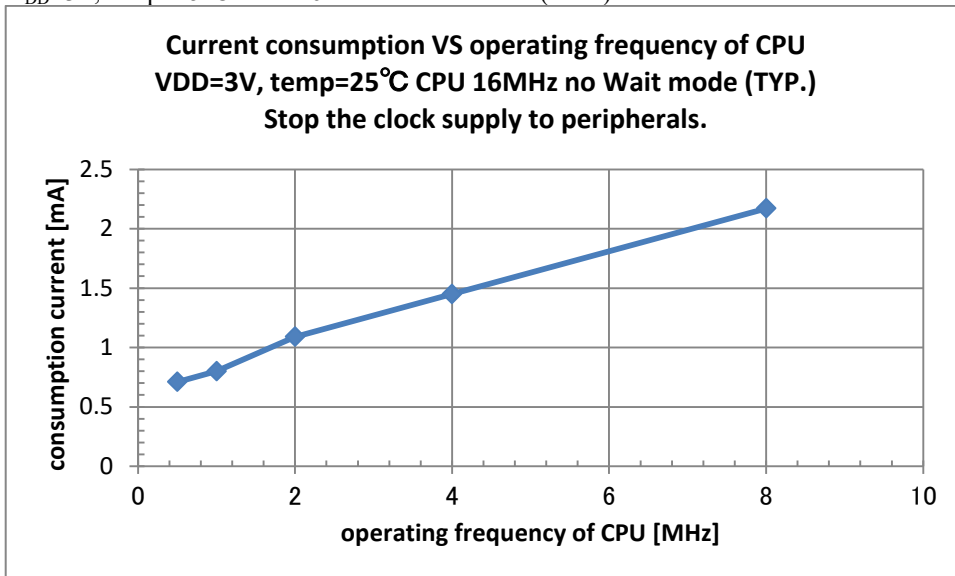

Product: ML62Q1700, ML62Q1701, ML62Q1702, ML62Q1703, ML62Q1704, ML62Q1710, ML62Q1711, ML62Q1712, ML62Q1713, ML62Q1714, ML62Q1720, ML62Q1721, ML62Q1722, ML62Q1723, ML62Q1724

Current consumption VS operating frequency of CPU

V_{DD}=3V, temp=25°C CPU 24MHz Wait mode (TYP.)

Stop the clock supply to peripherals.

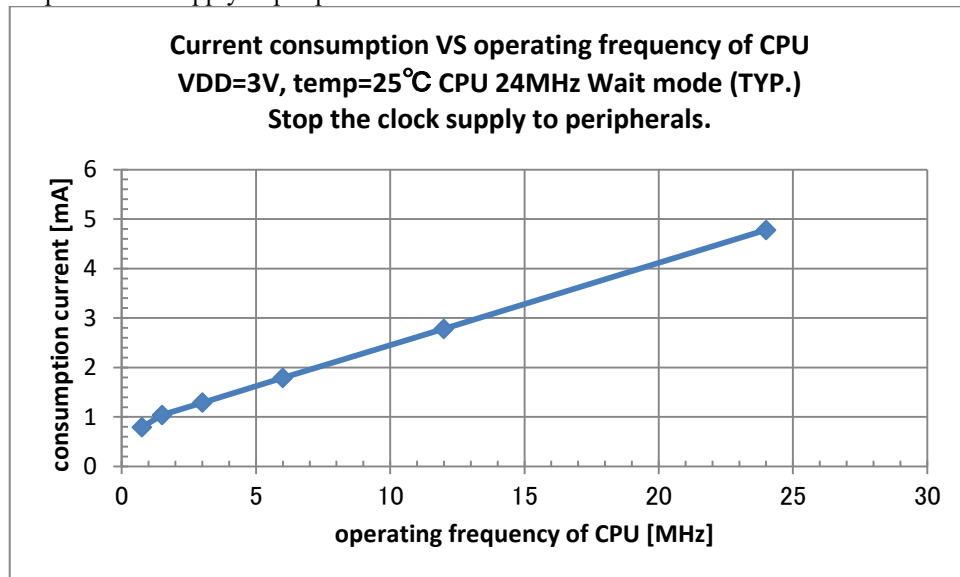

V_{DD}=3V, temp=25°C CPU 24MHz no Wait mode (TYP.)

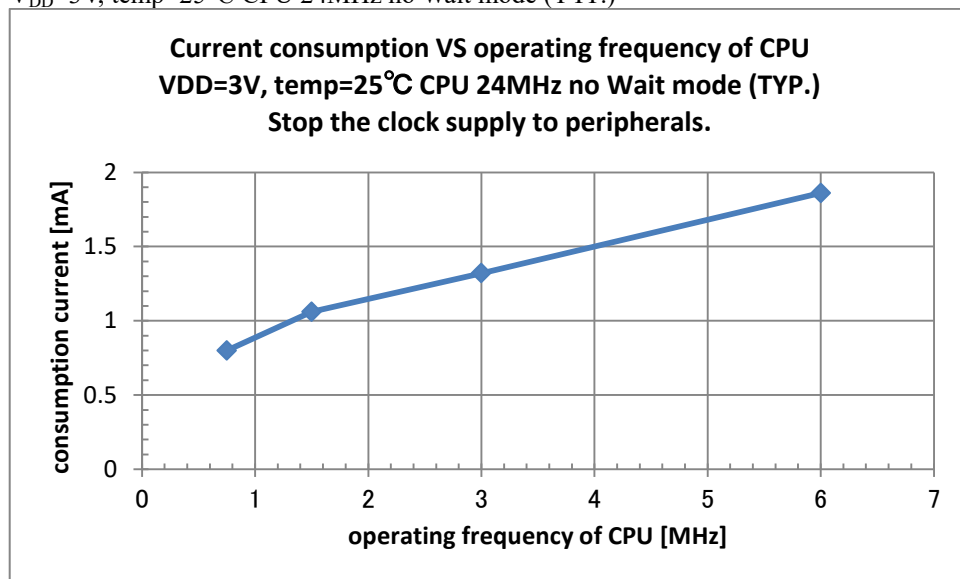

LAPIS Semiconductor Co.,Ltd.

FEDL62Q1700-03

Product: ML62Q1725, ML62Q1726, ML62Q1727,
ML62Q1733, ML62Q1734, ML62Q1735, ML62Q1736, ML62Q1737
ML62Q1743, ML62Q1744, ML62Q1745, ML62Q1746, ML62Q1747

Current consumption VS operating frequency of CPU
 $V_{DD}=3V$, temp= $25^{\circ}C$ CPU 16MHz Wait mode (TYP.)
Stop the clock supply to peripherals.

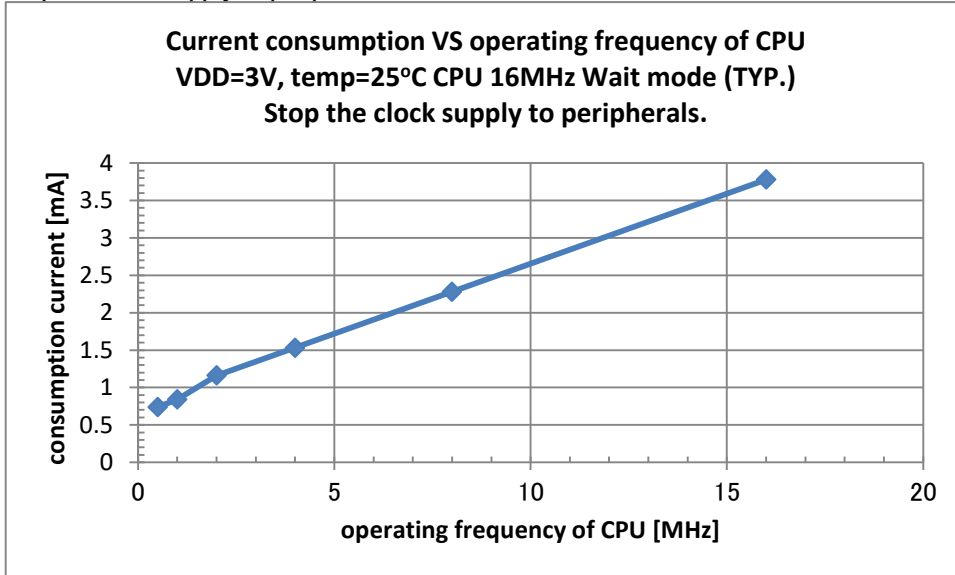

$V_{DD}=3V$, temp= $25^{\circ}C$ CPU 16MHz no Wait mode (TYP.)

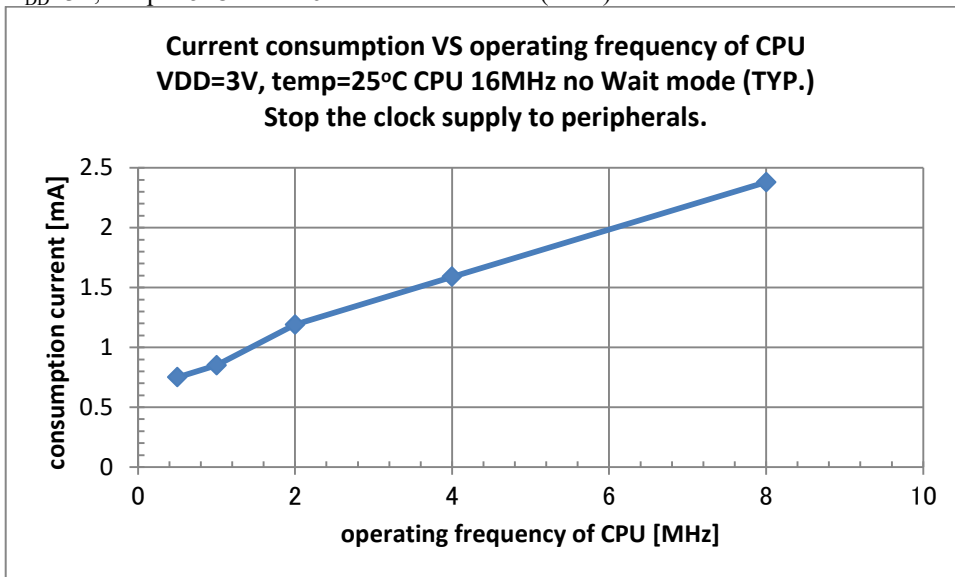

LAPIS Semiconductor Co.,Ltd.

FEDL62Q1700-03

Product: ML62Q1725, ML62Q1726, ML62Q1727,
ML62Q1733, ML62Q1734, ML62Q1735, ML62Q 1736, ML62Q1737
ML62Q1743, ML62Q1744, ML62Q1745, ML62Q 1746, ML62Q1747

Current consumption VS operating frequency of CPU
 $V_{DD}=3V$, temp= $25^{\circ}C$ CPU 24MHz Wait mode (TYP.)
Stop the clock supply to peripherals.

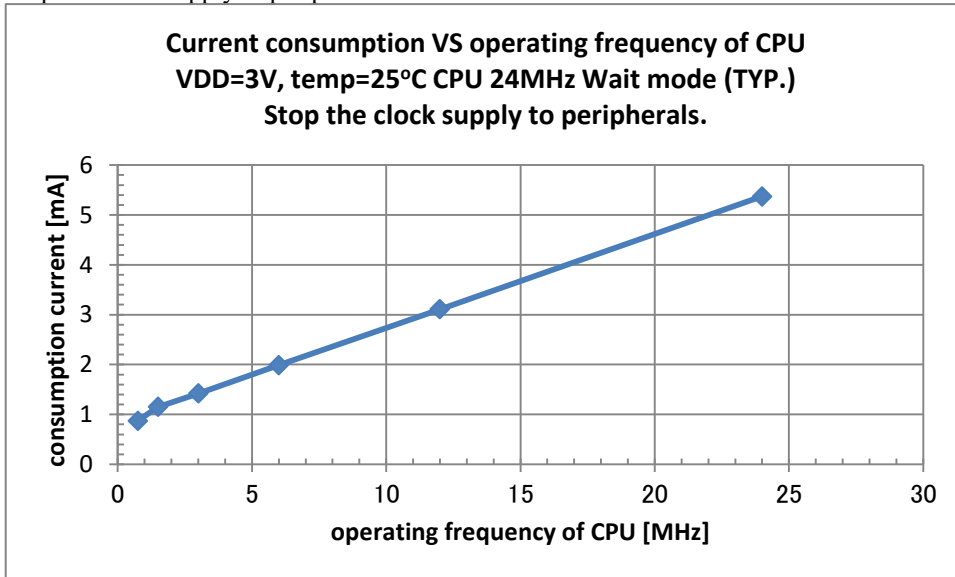

$V_{DD}=3V$, temp= $25^{\circ}C$ CPU 24MHz no Wait mode (TYP.)

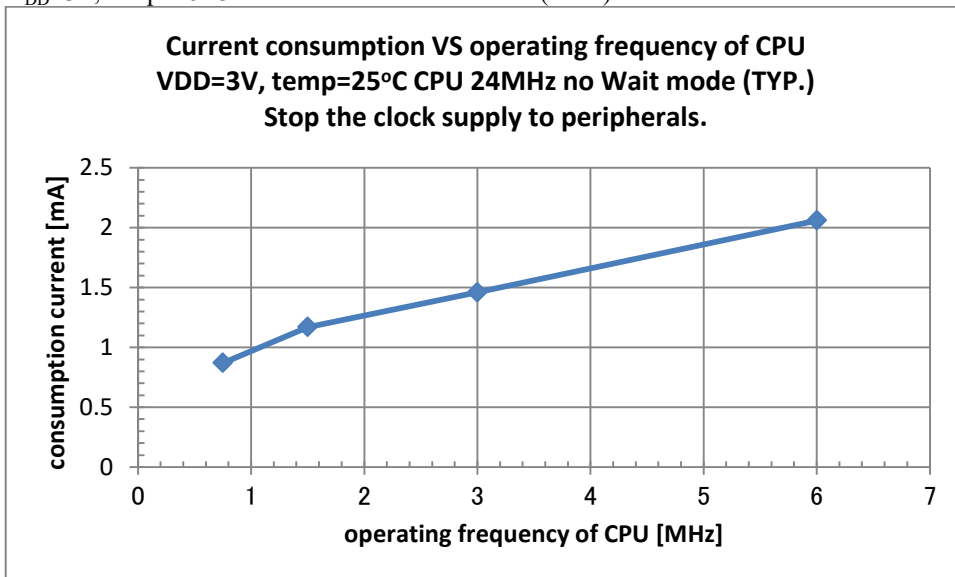

Product: ML62Q1728, ML62Q1729, ML62Q1738, ML62Q1739, ML62Q1748, ML62Q1749

Current consumption VS operating frequency of CPU
V_{DD}=3V, temp=25°C CPU 16MHz Wait mode (TYP.)
Stop the clock supply to peripherals.

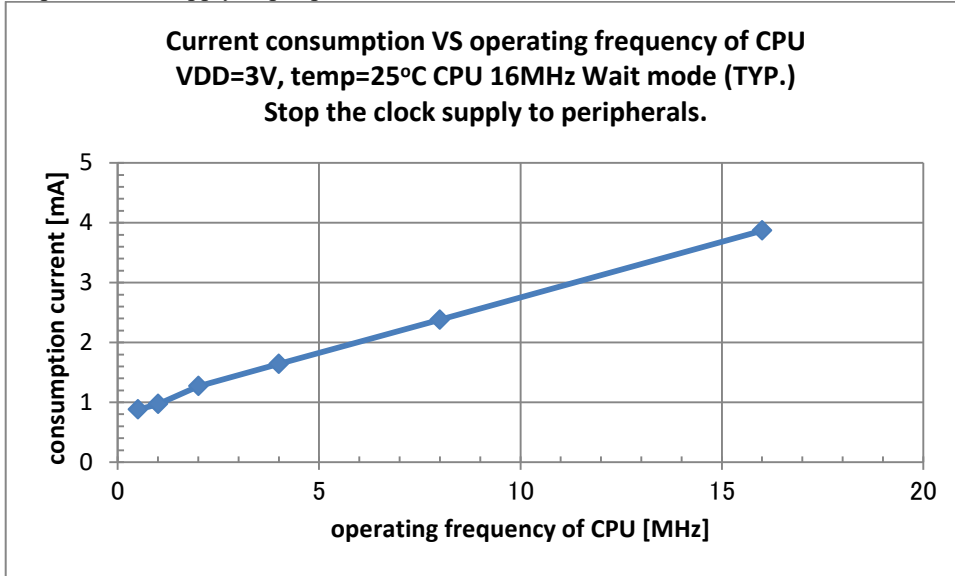

V_{DD}=3V, temp=25°C CPU 16MHz no Wait mode (TYP.)

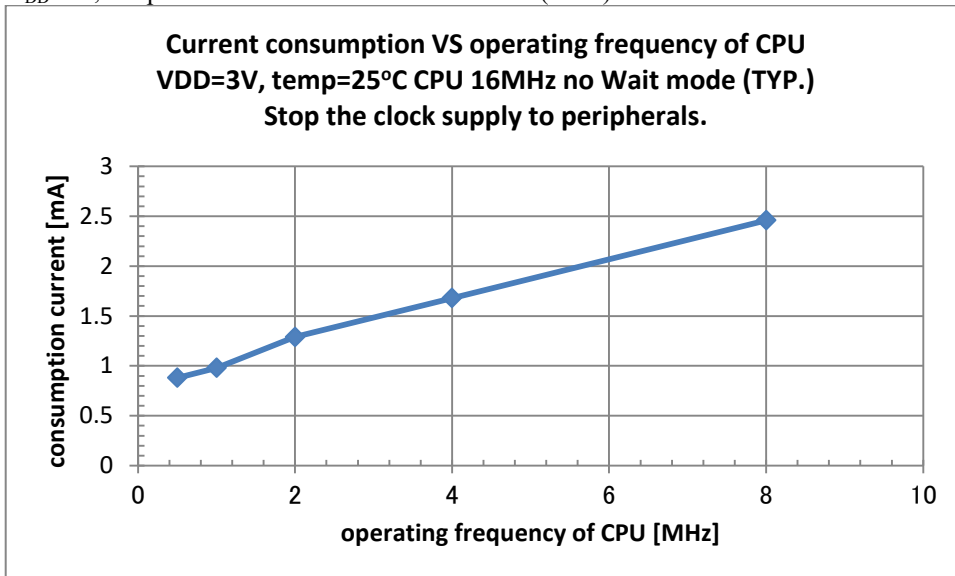

Product: ML62Q1728, ML62Q1729, ML62Q1738, ML62Q1739, ML62Q1748, ML62Q1749

Current consumption VS operating frequency of CPU
V_{DD}=3V, temp=25°C CPU 24MHz Wait mode (TYP.)
Stop the clock supply to peripherals.

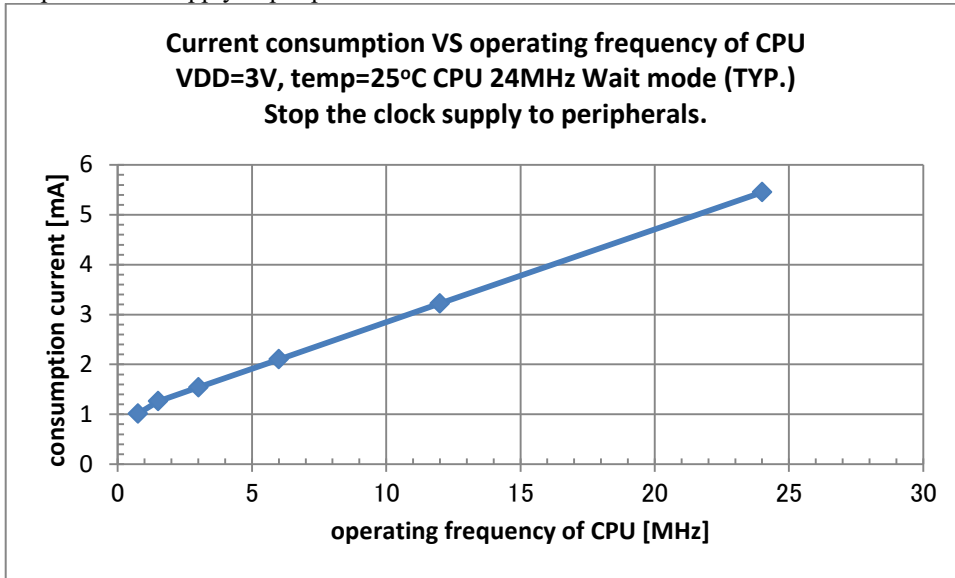

V_{DD}=3V, temp=25°C CPU 24MHz no Wait mode (TYP.)

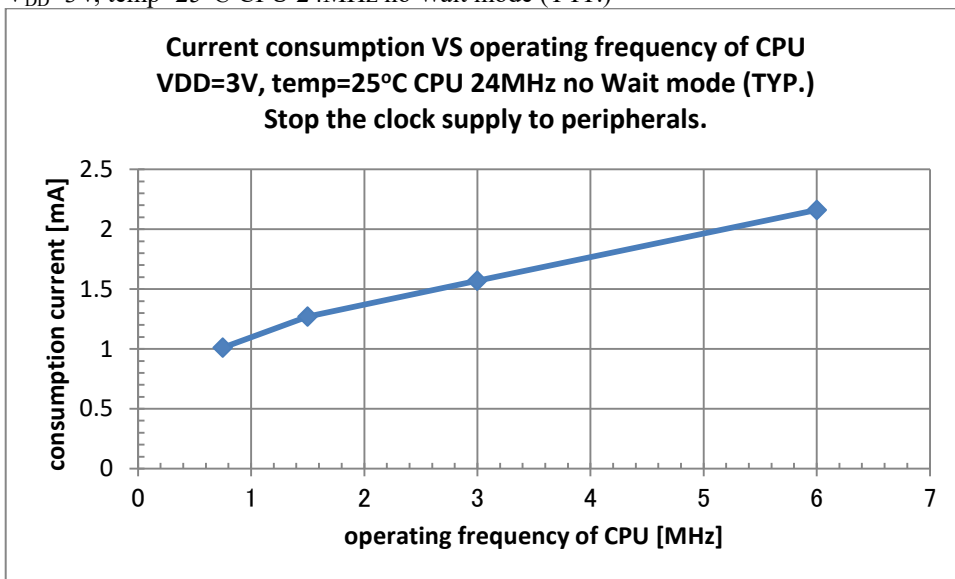

Consumption current of ADC VS operating voltage
PLL frequency=16MHz temp=25°C ch0 V_{REF}=V_{DD}

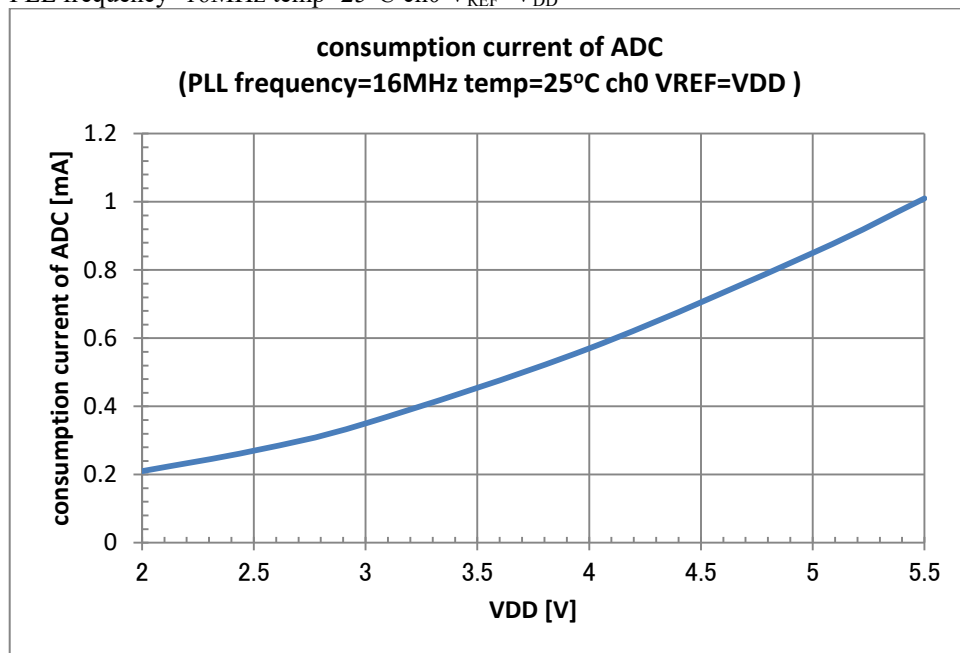

TEMP VS Low-speed RC oscillator frequency accuracy 1 without software adjustment (Typ.)

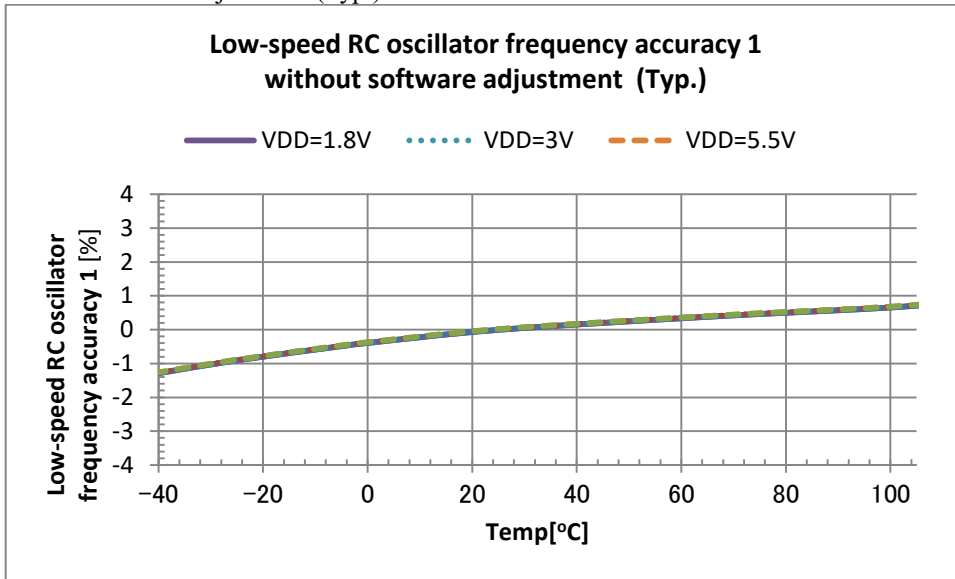

TEMP VS PLL oscillator frequency accuracy 1 without software adjustment (24MHz Typ.)

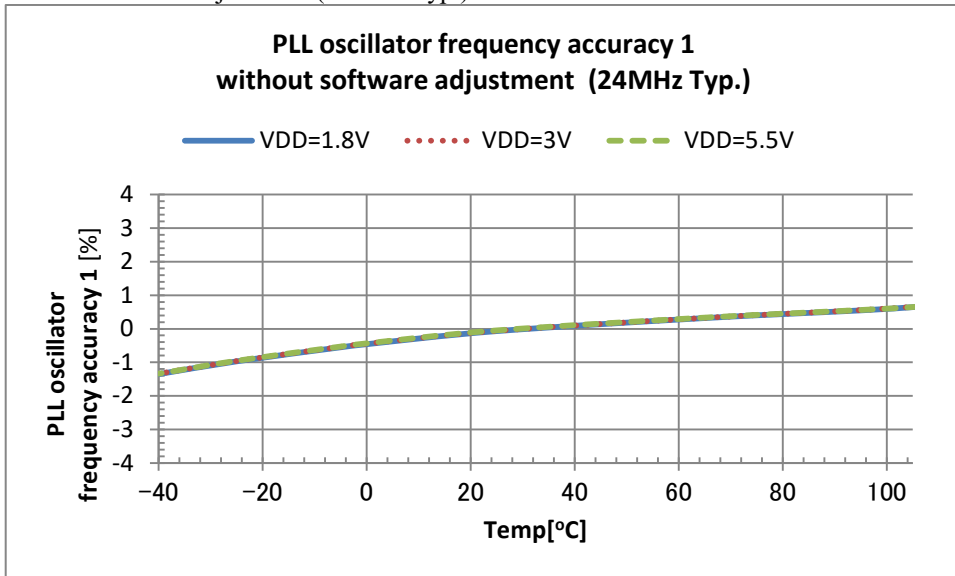

PACKAGE DIMENSIONS

48pin TQFP Package

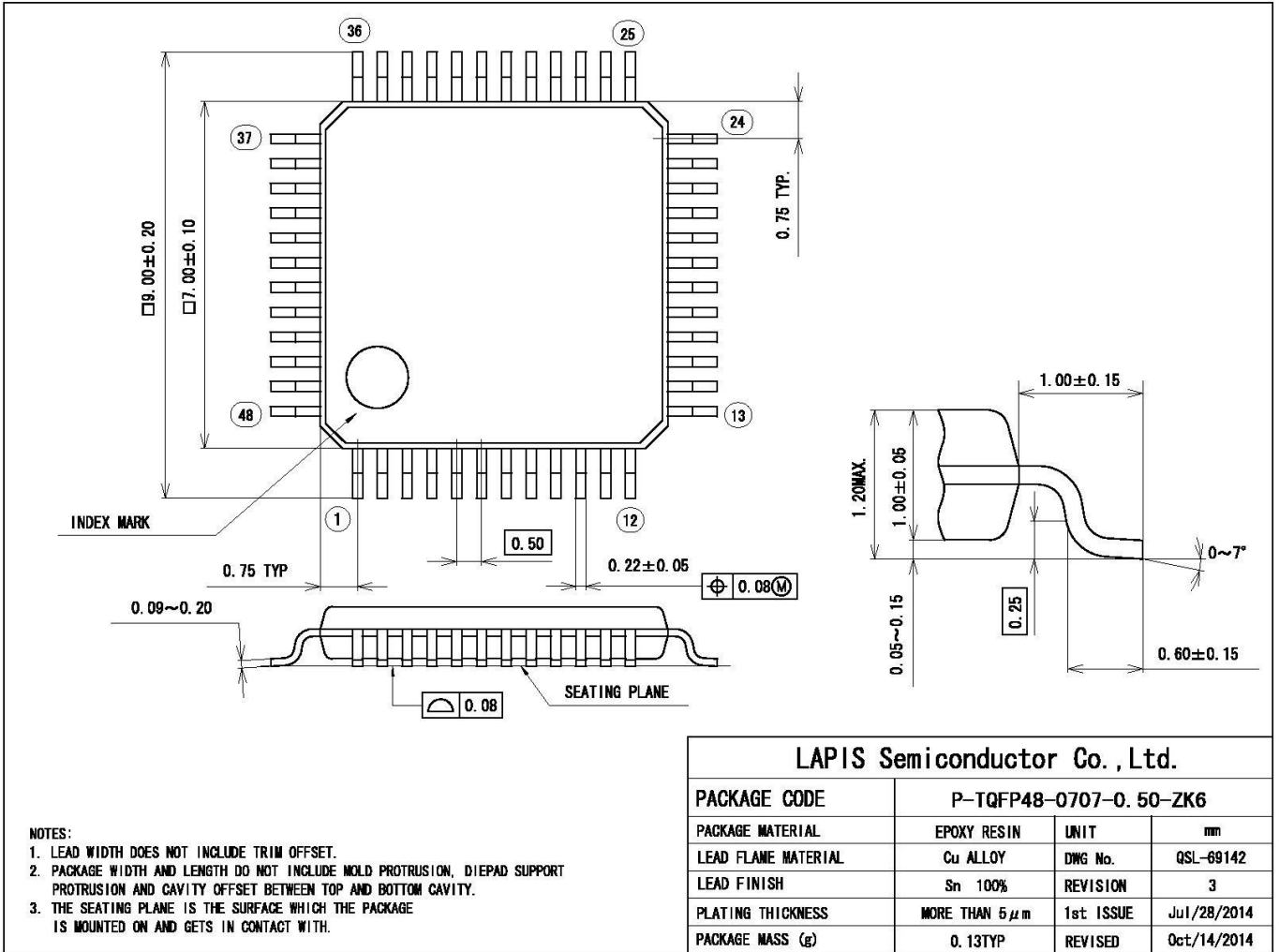

(Unit: mm)

Notes for Mounting the Surface Mount Type Package

The surface mount type packages are very susceptible to heat in reflow mounting and humidity absorbed in storage. Therefore, before you perform reflow mounting, contact a ROHM sales office for the product name, package name, pin number, package code and desired mounting conditions (reflow method, temperature and times).

52pin TQFP Package

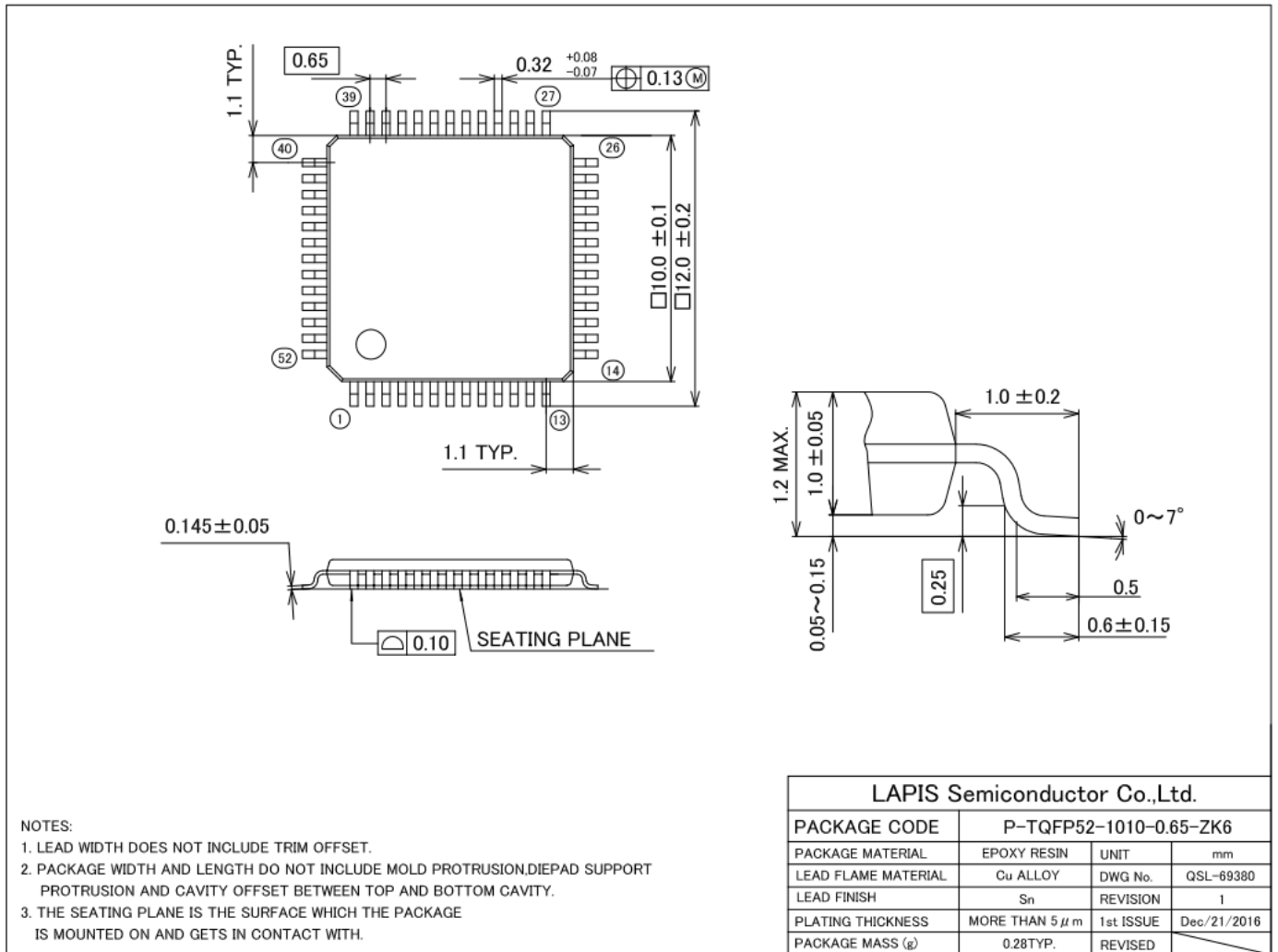

- NOTES:
1. LEAD WIDTH DOES NOT INCLUDE TRIM OFFSET.
 2. PACKAGE WIDTH AND LENGTH DO NOT INCLUDE MOLD PROTRUSION, DIEPAD SUPPORT PROTRUSION AND CAVITY OFFSET BETWEEN TOP AND BOTTOM CAVITY.
 3. THE SEATING PLANE IS THE SURFACE WHICH THE PACKAGE IS MOUNTED ON AND GETS IN CONTACT WITH.

(Unit: mm)

Notes for Mounting the Surface Mount Type Package

The surface mount type packages are very susceptible to heat in reflow mounting and humidity absorbed in storage. Therefore, before you perform reflow mounting, contact a ROHM sales office for the product name, package name, pin number, package code and desired mounting conditions (reflow method, temperature and times).

64pin TQFP Package

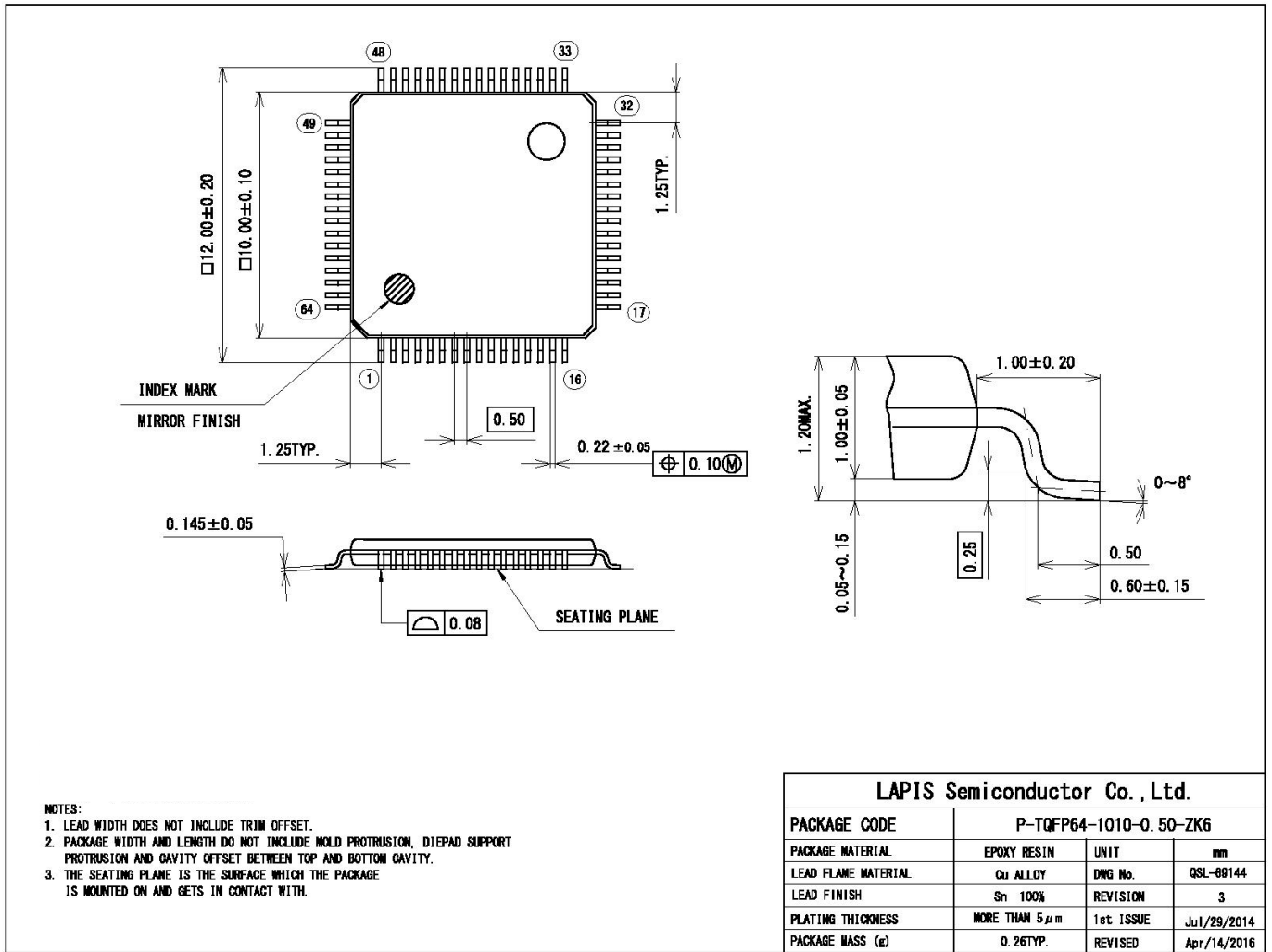

(Unit: mm)

Notes for Mounting the Surface Mount Type Package

The surface mount type packages are very susceptible to heat in reflow mounting and humidity absorbed in storage. Therefore, before you perform reflow mounting, contact a ROHM sales office for the product name, package name, pin number, package code and desired mounting conditions (reflow method, temperature and times).

64pin QFP Package

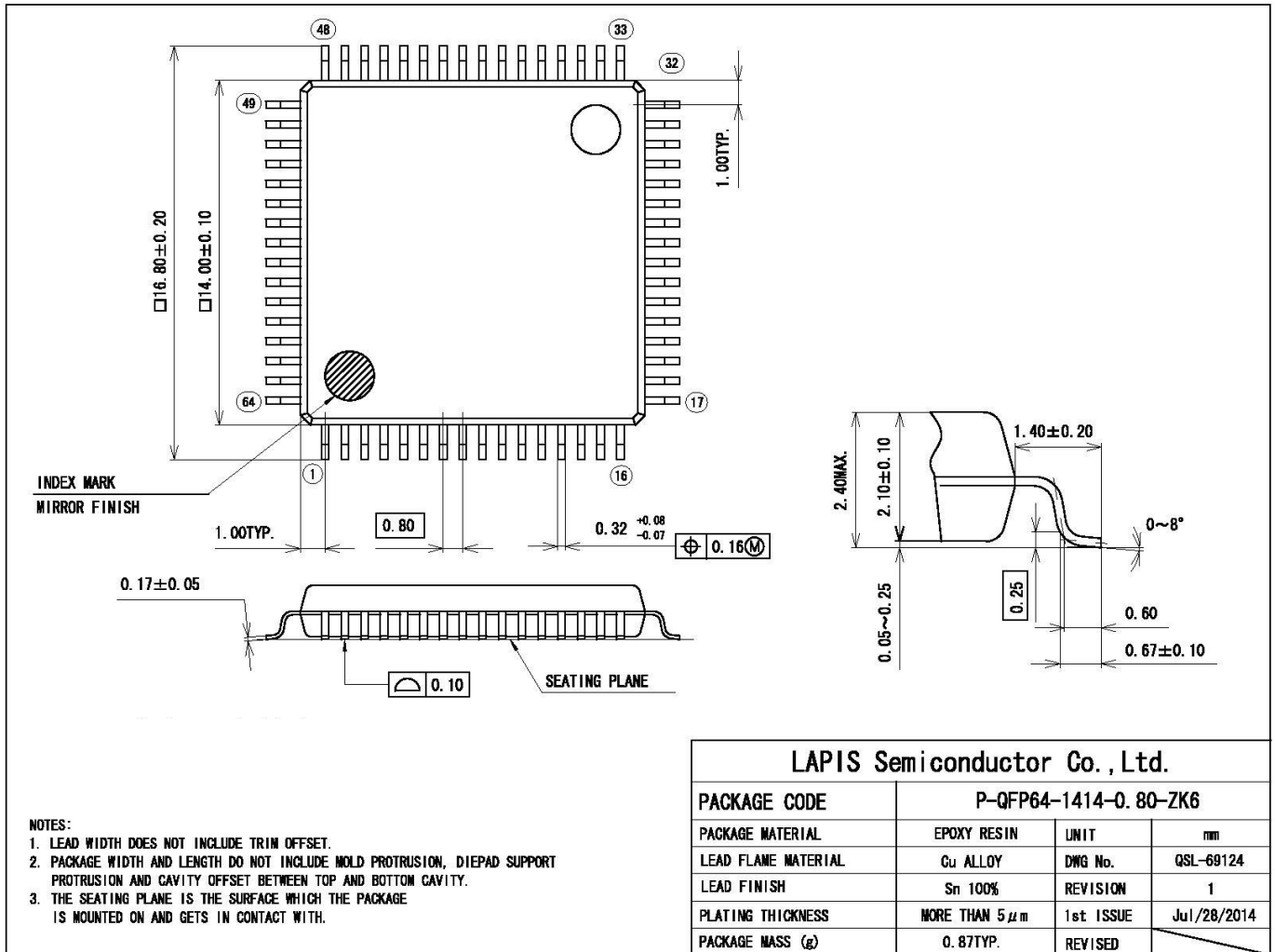

(Unit: mm)

Notes for Mounting the Surface Mount Type Package

The surface mount type packages are very susceptible to heat in reflow mounting and humidity absorbed in storage. Therefore, before you perform reflow mounting, contact a ROHM sales office for the product name, package name, pin number, package code and desired mounting conditions (reflow method, temperature and times).

80pin QFP Package

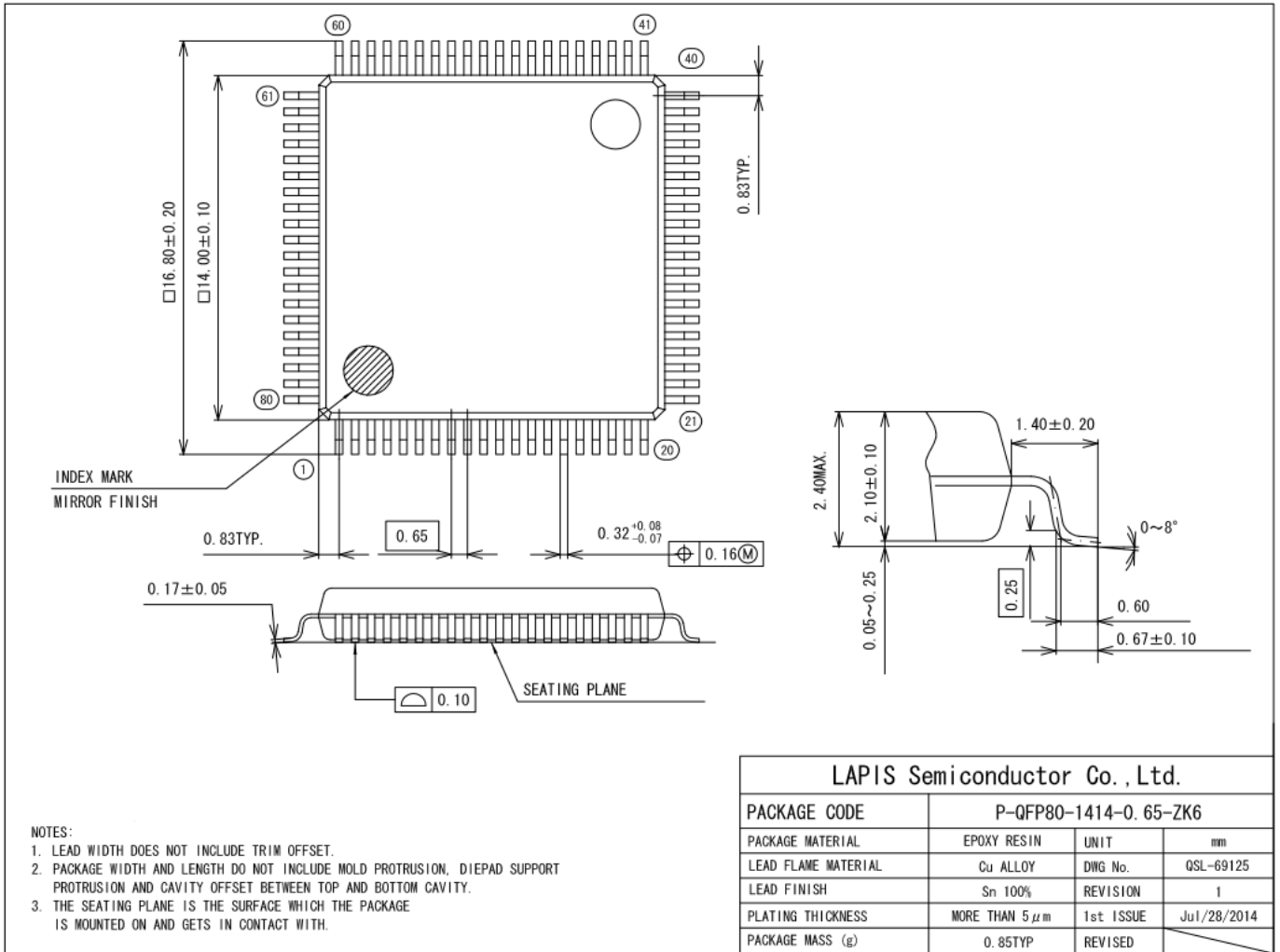

(Unit: mm)

Notes for Mounting the Surface Mount Type Package

The surface mount type packages are very susceptible to heat in reflow mounting and humidity absorbed in storage. Therefore, before you perform reflow mounting, contact a ROHM sales office for the product name, package name, pin number, package code and desired mounting conditions (reflow method, temperature and times).

100pin TQFP Package

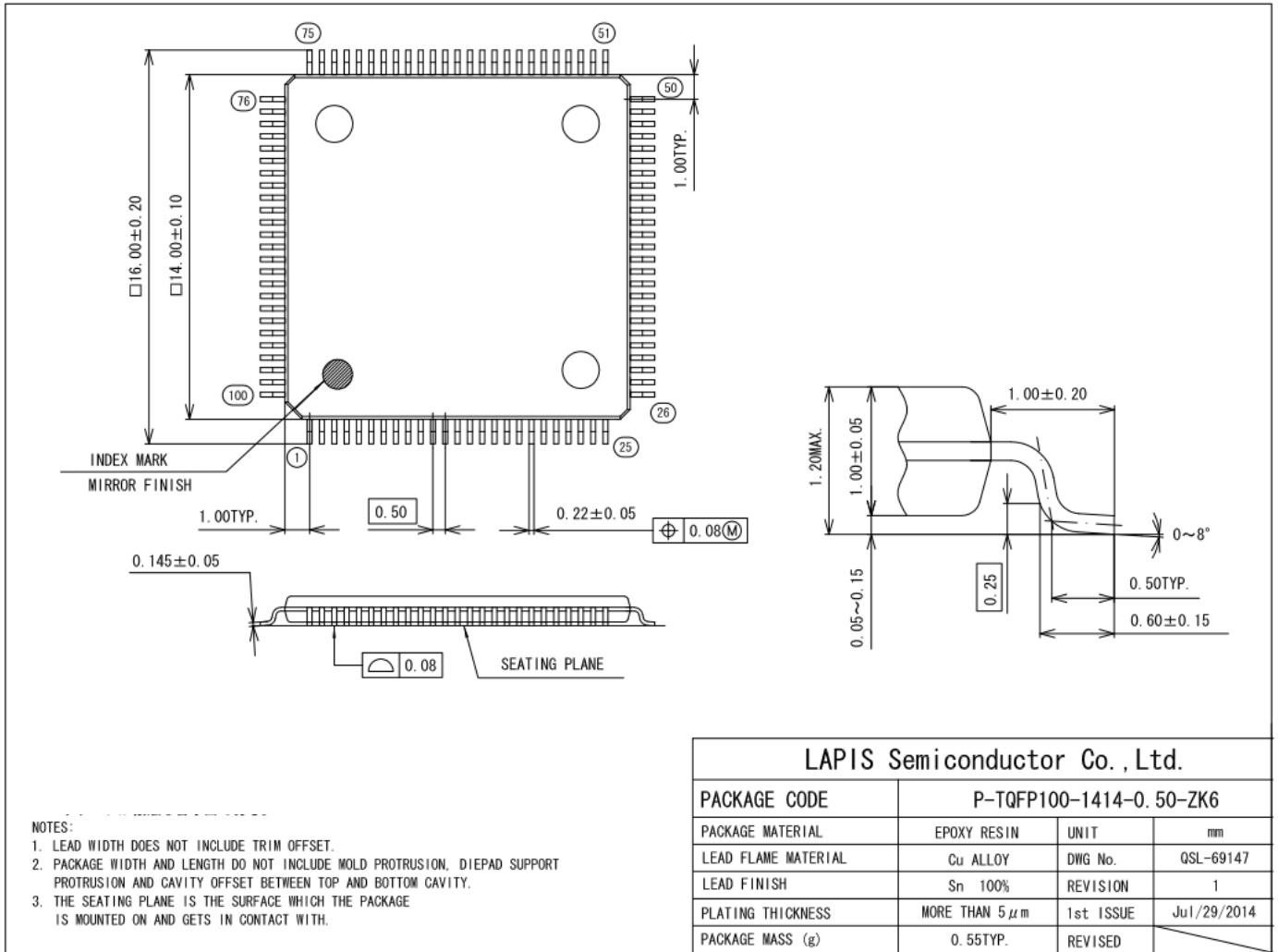

(Unit: mm)

Notes for Mounting the Surface Mount Type Package

The surface mount type packages are very susceptible to heat in reflow mounting and humidity absorbed in storage. Therefore, before you perform reflow mounting, contact a ROHM sales office for the product name, package name, pin number, package code and desired mounting conditions (reflow method, temperature and times).

100pin QFP Package

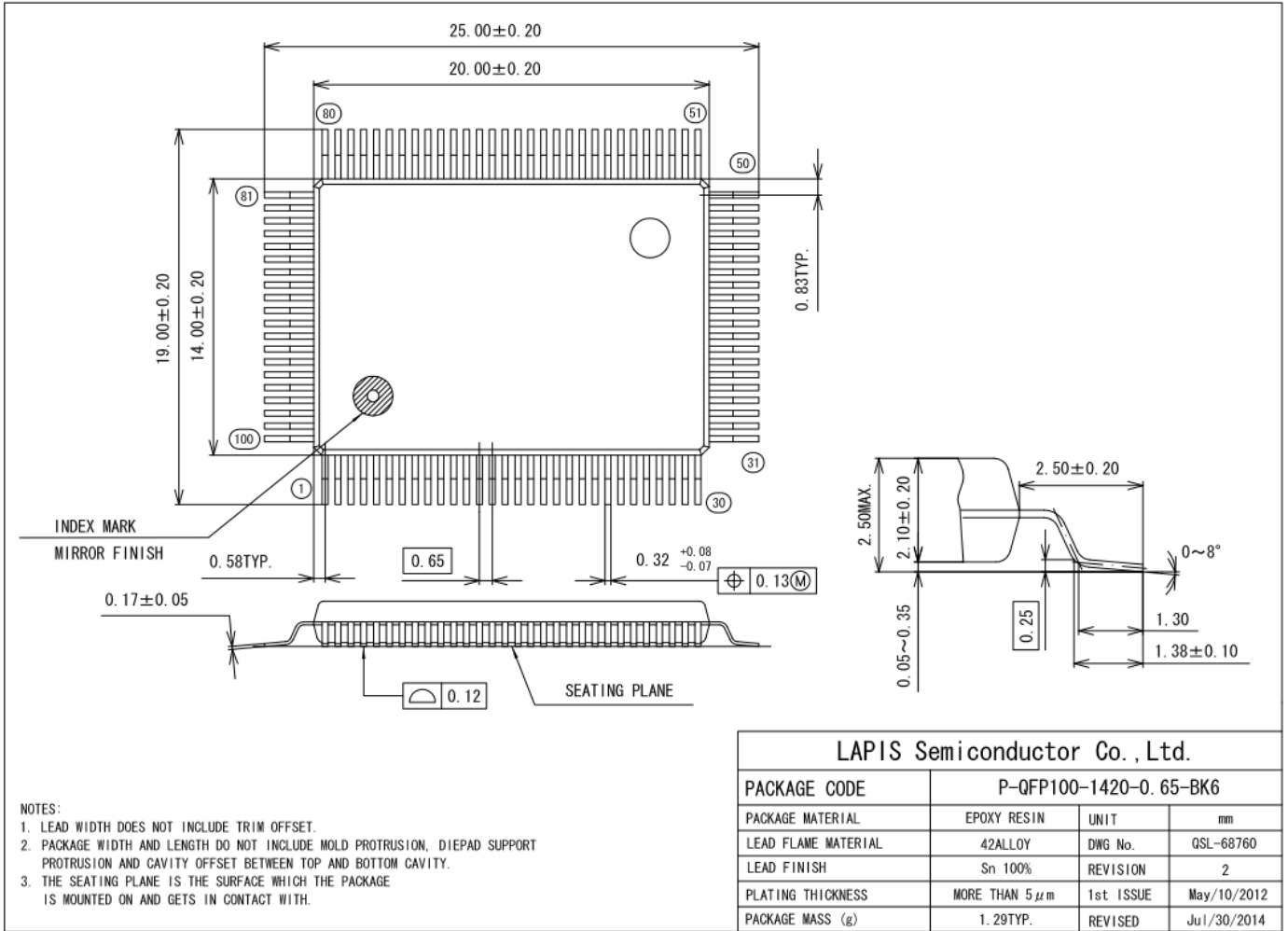

(Unit: mm)

Notes for Mounting the Surface Mount Type Package

The surface mount type packages are very susceptible to heat in reflow mounting and humidity absorbed in storage. Therefore, before you perform reflow mounting, contact a ROHM sales office for the product name, package name, pin number, package code and desired mounting conditions (reflow method, temperature and times).

REVISION HISTORY

Document No.	Date	Page		Description
		Previous Edition	Current Edition	
FEDL62Q1700-01	May 24, 2019	-	-	1 st Revision.
FEDL62Q1700-02	Mar 25, 2020	25	26	Changed termination of unused pins
		27	27	Added parameter "Operating temperature(Chip-Junction)" in Recommended Operating Conditions
		27	—	Removed the section "Operation Confirmed Crystal Unit(32.768kHz)". This section is mentioned in Applications Note; "Operation-confirmed oscillator for ML62Q1000 series".
		—	28	Added thermal characteristics section
		42	43	Added comments and notes to the reset characteristics
		42	44	Revised overall of "Power On Reset" section as "Slope of Power supply and Power On Reset" section. The major revisions are Added definitions of Power on rising/falling slope, Power on voltage, CPU operation start time, and added Note.
		*	*	Corrected typo
FEDL62Q1700-03	Jul 15, 2020	4,8,9	4,8,9	Changed comment for UART.
		23	23	Corrected description of SA-ADC in Table 4.
		27	27	Corrected comment in the parameter "Output voltage2"

Notes

- 1) The information contained herein is subject to change without notice.
- 2) Although LAPIS Semiconductor is continuously working to improve product reliability and quality, semiconductors can break down and malfunction due to various factors. Therefore, in order to prevent personal injury or fire arising from failure, please take safety measures such as complying with the derating characteristics, implementing redundant and fire prevention designs, and utilizing backups and fail-safe procedures. LAPIS Semiconductor shall have no responsibility for any damages arising out of the use of our Products beyond the rating specified by LAPIS Semiconductor.
- 3) Examples of application circuits, circuit constants and any other information contained herein are provided only to illustrate the standard usage and operations of the Products. The peripheral conditions must be taken into account when designing circuits for mass production.
- 4) The technical information specified herein is intended only to show the typical functions of the Products and examples of application circuits for the Products. No license, expressly or implied, is granted hereby under any intellectual property rights or other rights of LAPIS Semiconductor or any third party with respect to the information contained in this document; therefore LAPIS Semiconductor shall have no responsibility whatsoever for any dispute, concerning such rights owned by third parties, arising out of the use of such technical information.
- 5) The Products are intended for use in general electronic equipment (i.e. AV/OA devices, communication, consumer systems, gaming/entertainment sets) as well as the applications indicated in this document.
- 6) The Products specified in this document are not designed to be radiation tolerant.
- 7) For use of our Products in applications requiring a high degree of reliability (as exemplified below), please contact and consult with a LAPIS Semiconductor representative: transportation equipment (i.e. cars, ships, trains), primary communication equipment, traffic lights, fire/crime prevention, safety equipment, medical systems, servers, solar cells, and power transmission systems.
- 8) Do not use our Products in applications requiring extremely high reliability, such as aerospace equipment, nuclear power control systems, and submarine repeaters.
- 9) LAPIS Semiconductor shall have no responsibility for any damages or injury arising from non-compliance with the recommended usage conditions and specifications contained herein.
- 10) LAPIS Semiconductor has used reasonable care to ensure the accuracy of the information contained in this document. However, LAPIS Semiconductor does not warrant that such information is error-free and LAPIS Semiconductor shall have no responsibility for any damages arising from any inaccuracy or misprint of such information.
- 11) Please use the Products in accordance with any applicable environmental laws and regulations, such as the RoHS Directive. For more details, including RoHS compatibility, please contact a ROHM sales office. LAPIS Semiconductor shall have no responsibility for any damages or losses resulting non-compliance with any applicable laws or regulations.
- 12) When providing our Products and technologies contained in this document to other countries, you must abide by the procedures and provisions stipulated in all applicable export laws and regulations, including without limitation the US Export Administration Regulations and the Foreign Exchange and Foreign Trade Act.
- 13) This document, in part or in whole, may not be reprinted or reproduced without prior consent of LAPIS Semiconductor.

Copyright 2019 - 2020 LAPIS Semiconductor Co., Ltd.

LAPIS Semiconductor Co.,Ltd.

2-4-8 Shinyokohama, Kouhoku-ku,
Yokohama 222-8575, Japan
<http://www.lapis-semi.com/en/>

X-ON Electronics

Largest Supplier of Electrical and Electronic Components

Click to view similar products for [16-bit Microcontrollers - MCU category](#):

Click to view products by [ROHM manufacturer](#):

Other Similar products are found below :

[M30302FCPP#U3](#) [MB90F036APMC-GSE1](#) [MB90F428GCPFR-GSE1](#) [MB96F683RBPMC-GSAE1](#) [R5F10MMGDFB#30](#)
[R5F111PGGFB#30](#) [R5F117BCGNA#20](#) [DF3026XBL25V](#) [DF36014GFTV](#) [DF36014GFXV](#) [DF36024GFTV](#) [DF36034GFPV](#)
[R5F11B7EANA#U0](#) [R5F21172DSP#U0](#) [MB90092PF-G-BNDE1](#) [MB90F335APMC1-G-SPE1](#) [MB90F345CAPFR-GSE1](#) [MB90F568PMCR-GE1](#) [MB90F882ASPMC-GE1](#) [MB96F395RSAPMC-GSE2](#) [DF36024GFXV](#) [UPD78F1018F1-BA4-A](#) [MB96F018RBPMC-GSE1](#)
[MB90F867ASPFR-GE1](#) [DF2239FA20IV](#) [R5F117BCGFP#30](#) [LC88F58B0AU-SQFPH](#) [MB90F548GPF-GE1](#) [MB90214PF-GT-310-BND-AE1](#)
[MB90F342CESPQC-GSE2](#) [MB90F428GAPF-GSE1](#) [ML62Q504H-NNNTBWBX](#) [S912ZVH128F2VLL](#) [UPD78F1500AGK-GAK-AX](#)
[HD64F3337SF16V](#) [MB90F428GCPF-GSE1](#) [MB90F342ESPMC-G-JNE1](#) [MB90022PF-GS-358E1](#) [MB96F395RWAPMC-GSE2](#)
[MB96395RSAPMC-GS-110E2](#) [MB90F883CSPMC-GE1](#) [S912ZVHY64F1CLL](#) [S912ZVHY64F1VLQ](#) [ST10F280](#) [MB96F338RSAPMCR-GK5E2](#) [CY90096PF-G-002-BND-ERE1](#) [ML62Q1569-NNNGAZ0AX](#) [ML62Q1739-NNNGAZ0AX](#) [ML62Q1749-NNNGAZ0AX](#)
[ML62Q1579-NNNGAZ0AX](#)