

envelope \varnothing 15,5mm in final assembled state

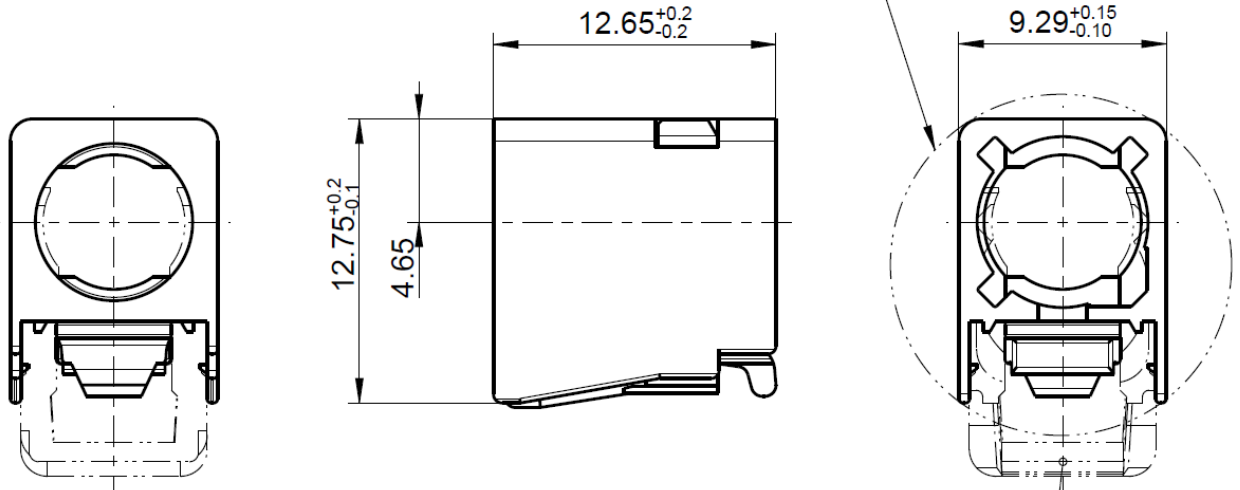

Kabelabgang 360°, frei drehbar
 cable junction 360°, free turnable

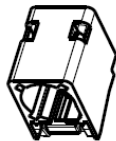

secondary-locking, in delivery condition
 (pre assembled position)

All dimensions are in mm; tolerances according to ISO 2768 m-H
 Y = Part number has to be accomplished by codification

Interface

According to DIN 72594-1

Material

Connector parts

Housing	POM
Secondary Lock	POM

Mechanical data

Mating cycles	≥ 25
Retention force latch	≥ 110 N
Retention force primary lock	≥ 80 N
Retention force secondary lock	≥ 60 N
Coding efficiency	≥ 40 N

Environmental data

Temperature range	-40°C to +105°C
Thermal shock	DIN 72594-2 clause 8.2
Temperature and humidity	DIN 72594-2 clause 8.3
Vibration and mechanical shock	DIN 72594-2 clause 8.1
Dry heat	DIN 72594-2 clause 8.4
RoHS	compliant

Application

Applicable e.g. for following connectors: 59K25A-1xxA4*
 59K25C-1xxA4*
 59K25H-1xxA4*
 59K2DV-1xxA4* ^(e)















^{*)} -xx for all available cable variations

Packing

Standard 2500 pcs in box ^(f)
 2500 pcs in reusable container
 Weight 0.91 g/pce

Coding

Part Number has to be accomplished by codification

Coding	Color	RAL	Part-Number
 A	black	sim. 9005	59Z006-T00-A
 B	white	sim. 9001	59Z006-T00-B
 C	blue	sim. 5005	59Z006-T00-C
 D	bordeauxviolet	sim. 4004	59Z006-T00-D
 E	green	sim. 6002	59Z006-T00-E
 F	brown	sim. 8011	59Z006-T00-F
 G	grey	sim. 7031	59Z006-T00-G
 H	violet	sim. 4003	59Z006-T00-H
 I	beige	sim. 1001	59Z006-T00-I
 K	curry	sim. 1027	59Z006-T00-K
 L	Carmine red	sim. 3002	59Z006-T00-L
 M	pastel orange	sim. 2003	59Z006-T00-M
 N	pastel green	sim. 6019	59Z006-T00-N
 Z	waterblue	sim. 5021	59Z006-T00-Z

Change History

Rev.	Date	Change
e00	22.05.17	- added 59K2DV-xxx at Applications
f00	15.11.21	Packaging sizes updated -old packaging size "500 pcs in box" -updated to "2500 pcs in box" and "2500 pcs in reusable container"

Dieses Dokument ist urheberrechtlich geschützt • This document is protected by copyright • Rosenberger Hochfrequenztechnik GmbH & Co. KG

While the information has been carefully compiled to the best of our knowledge, nothing is intended as representation or warranty on our part and no statement herein shall be construed as recommendation to infringe existing patents. In the effort to improve our products, we reserve the right to make changes judged to be necessary.

For the installation of the electrotechnical equipment, particular electrotechnical expertise is required.



Draft	Date	Approved	Date	Rev.	Engineering change number	Name	Date
D. Oberhöller	04.04.05	F. Danzl	15.11.21	f00	21-1468	S. Guggenberger	15.11.21
Rosenberger Hochfrequenztechnik GmbH & Co. KG P.O.Box 1260 D-84526 Tittmoning Germany www.rosenberger.de						Tel. : +49 8684 18-0 Email : info@rosenberger.de	
							Page
							3 / 3

RF_35/09.14/6.2

X-ON Electronics

Largest Supplier of Electrical and Electronic Components

Click to view similar products for [RF Connector Accessories](#) category:

Click to view products by [Rosenberger](#) manufacturer:

Other Similar products are found below :

[89674-0712](#) [F702RX24](#) [FERRULE-174](#) [R141802000](#) [R141805000](#) [R141842000](#) [R161862000](#) [R161862000W](#) [R280752000](#) [R280907000](#)
[R694261906](#) [RFI21-13](#) [RFI75-13-D2](#) [RFI75-4-D2](#) [AX102906](#) [AX102907](#) [18097-0013](#) [HP-375](#) [HP-500](#) [2098-0294-00](#) [2098-3251-94](#) [KA-](#)
[81-05](#) [89674-0805](#) [F1](#) [FERRULE-223](#) [202102-11](#) [213337-1](#) [220222-2](#) [24092671A](#) [24092678A](#) [R280468000](#) [R280510000](#) [R282862060](#)
[RFI155-1](#) [RFI25-12-D3](#) [RFI25-5](#) [RFI25-5-D3](#) [RFI75-12-D2](#) [RFI75-2-D2](#) [RFI75-4-D3](#) [RFI77-6](#) [360HS001M2508M6](#) [4-1532137-4](#) [5-21085-](#)
[0](#) [105274-1000](#) [111062-0490](#) [112122-SOD-LUG](#) [112-NUT-KNURL](#) [IPP-2014](#) [R280490020](#)