

7/16
50Ω

ATTENUATOR PLUG/JACK

60AS120-K06N1

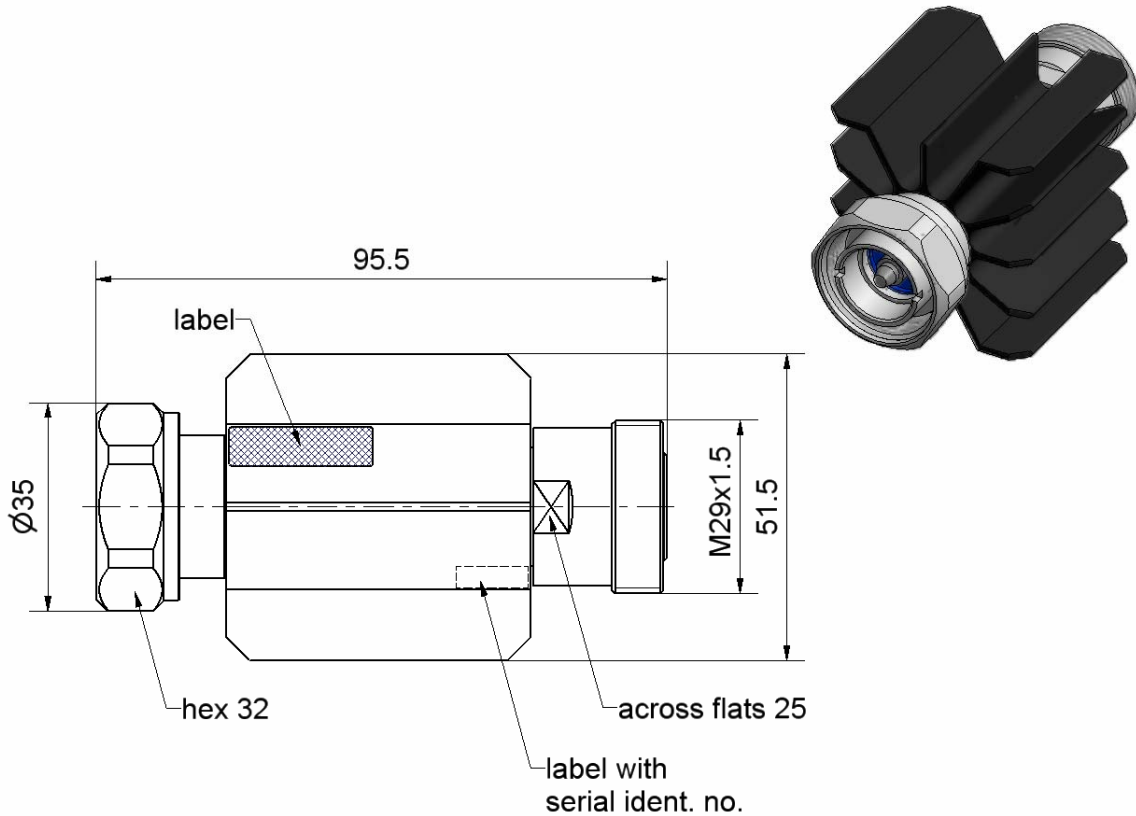

All dimensions are in mm; tolerances according to ISO 2768 m-H

Interface

According to IEC 60169-4, VG 95250, EN 122190, DIN 47223

Documents

N/A

Material and plating

Connector parts

	Material	Plating
Center contact - plug	Brass	Silver, 3-6 µm
Center contact - jack	Beryllium copper	Silver, 3-6 µm
Outer contact	Brass	Flash white bronze over silver(e.g. Optargen®)
Body	Brass	Flash white bronze over silver(e.g. Optargen®)
Heatsink	Al	black anodised
Coupling nut	Brass	Flash white bronze over silver(e.g. Optargen®)
Dielectric	PPE	
Substrate	ALN	

RF_35/08.06/4.0

7/16
50Ω

ATTENUATOR PLUG/JACK

60AS120-K06N1

Electrical data

Impedance 50 Ω
 Frequency DC to 8 GHz
 Return loss ≥ 30.7 dB, DC to 1 GHz
 ≥ 26.4 dB, 1 GHz to 2 GHz
 ≥ 20.0 dB, 2 GHz to 8 GHz
 Attenuation 6 dB
 Tolerances ≤ ± 0.3 dB, DC to 2 GHz
 ≤ ± 0.4 dB, 2 GHz to 4 GHz
 ≤ ± 0.8 dB, 4 GHz to 8 GHz
 Center contact resistance ≤ 4.0 mΩ
 Outer contact resistance ≤ 1.5 mΩ
 Power handling 20 W at 25°C
 derated linearity to 0 Watts at 125°C

Mechanical data

Mating cycles min. 500
 Coupling nut retention ≥ 1000 N
 Center contact captivation ≥ 200 N
 Coupling test torque max. 35 Nm
 Recommended torque 25 Nm to 30 Nm

Environmental data

Temperature range -65°C to +85°C
 2002/95/EC (RoHS) compliant

Tooling

N/A

Suitable cables

N/A

Packing

Standard 1 pce in bag
 Weight 270 g/pce

While the information has been carefully compiled to the best of our knowledge, nothing is intended as representation or warranty on our part and no statement herein shall be construed as recommendation to infringe existing patents. In the effort to improve our products, we reserve the right to make changes judged to be necessary.

Draft	Date	Approved	Date	Rev.	Engineering change number	Name	Date
Kerstin Herzog	29/03/05	Frank Weiß	07/07/08	c00	08-0348	Kerstin Hobrak	08/07/08
Rosenberger Hochfrequenztechnik GmbH & Co. KG P.O.Box 1260 D-84526 Tittmoning Germany www.rosenberger.de					Tel.: +49 8684 18-0 Fax: +49 8684 18-499 email: info@rosenberger.de		Page 2 / 2

X-ON Electronics

Largest Supplier of Electrical and Electronic Components

Click to view similar products for [Attenuators - Interconnects](#) category:

Click to view products by [Rosenberger](#) manufacturer:

Other Similar products are found below :

[R411803119](#) [R413806115](#) [R413808000](#) [R413810115](#) [R413850115](#) [R414510000](#) [R414701000](#) [BNC-13](#) [R411800121](#) [R411801121](#)
[R412412124](#) [R412450000](#) [R413800000](#) [R413805000](#) [R413830000](#) [R413840115](#) [R414730000](#) [R415420000](#) [R415703000](#) [R416010000](#)
[R420003110](#) [R411801000](#) [R411815121](#) [R413305000](#) [R413801000](#) [R414520000](#) [R411808121](#) [R412500124](#) [R412414124](#) [R412501124](#)
[HMC-C584](#) [R413802000](#) [R412400124](#) [R411700124](#) [R417310130](#) [R411801119](#) [R412419124](#) [R411703124](#) [R412401124](#) [R443131000](#)
[R417130110](#) [R414700000](#) [R414505000](#) [R411802119](#) [R417720128](#) [R420706110](#) [R413811000](#) [R413803115](#) [R414501000](#) [R417903128](#)