

Rosenberger

Power and Data Transmission for LEV

RoPD[®] & RoDC Connecting Systems

AUTOMOTIVE





Rosenberger Group

Rosenberger is one of the world's leading manufacturers of impedance-controlled and optical connectivity solutions. We provide solutions in high-frequency, high-voltage and fiber-optic technology for mobile communication networks, data centers, test & measurement applications, automotive electronics, as well as high-voltage contact systems, medical electronics and aerospace engineering.

A global network of R&D, manufacturing and assembly locations provides innovation, optimized cost structure and excellent customer services. Around 11,000 employees are involved in the development, production and distribution of our products.



Contents

Rosenberger Group	2
Competencies & Technology	4
Quality & Environment	5
Magnetic Self-Mating Locking Systems	6
RoPD® – Rosenberger Power Data	7
RoDC – Rosenberger Data Connector	10

The Rosenberger online catalog contains the current RoPD® product range with specific details, including data sheets, assembly instructions and panel piercings.

www.rosenberger.com/ok/ropd



Competencies & Technology

Rosenberger's mission is to be recognized as an innovation and technology leader within its business segments. The most modern manufacturing technologies, the highest possible levels of efficiency in production and continuous development are our core competencies guaranteeing not only fast delivery and strict adherence to delivery dates, but also the highest levels in product quality.





Quality & Environment

Ensuring the optimum quality of products and services and taking responsibility for our environment are fundamental elements of Rosenberger's corporate philosophy.

Our approach to ensuring quality covers more than just the optimization of parts and products – it also includes the continuous improvement of all company processes: from product development, planning, procurement, production, sales, and logistics right through to environmental policy.

To summarize, we want to offer maximum benefits for our customers all over the world.

We aim to act in an environmentally conscious manner, use materials economically, protect natural resources, recycle, and ensure energy efficiency.

As we have continuously improved our processes and consistently applied our quality management systems, we have been awarded many certificates.

Certifications

- IATF 16949
- DIN EN 9100
- ISO 9001
- ISO 14001
- DaKKs accreditation according to DIN EN ISO 17025

Rosenberger has won a number of prestigious quality awards and prizes from several renowned customers and organizations for achieving its quality and environmental objectives.

Magnetic Self-Mating Locking Systems

Magnetic Self-Mating

Rosenberger has developed a locking system that offers an intelligent alternative to mechanical coupling connections. The magnetic self-mating connectors provide all common functions and are suitable for power and data transmission. Self-mating works as follows: When the plug is approaching the socket, it is attracted by the magnetic force and virtually slides into the socket by itself. This makes it efficient and comfortable handling and ensures a correct connection.

Break-Away Function

This is designed to break the connection should the plug or cable be subjected to an acute tensile force (intentional or unintentional). It avoids the risk of injury to the user and damage to the connectors or devices. The deliberate removal of the plug is also fast and simple due to the break-away function.

Perfect handling

- No risk of canting or similar
- Reliable connections even for hard-to-reach positions
- Forced disconnection causes no damage to connector or vehicle /device

Applications

Magnetic connectors are suitable for the Light Electric Vehicles Industry (LEV), e.g. pedelecs, e-bikes, e-scooters and wheelchairs, for Unmanned Ground Vehicles (UGVs), e.g. robotics as well as drones.



RoPD® – Rosenberger Power Data

RoPD® Connectors – Exploring Generation LEV

RoPD® – **R**osenberger **P**ower **D**ata Connectors with magnetic self-mating mechanism are purpose-designed for Light Electric Vehicles (LEV) including e-bikes, e-scooters and pedelecs. Providing fast and reliable magnetic connection, these are particularly suited to data communication and power transmission of voltages up to 60 V and current loads up to 40 A. The magnetic locking and precision self-mating capability prevents any accidental or forced disconnection from damaging the connector or the LEV. Furthermore, the high tolerance pin and socket design permits a large number of mating cycles.

The RoPD® connection system is ideal for many LEV connection applications – including battery changing and charging – where frequent connection and disconnection is required. The four data contacts and two power transmission pins make a hot-plug capability unnecessary as the data contacts activate the power following connection. For added flexibility the data contacts can be used as a BUS system with an additional supply voltage. Versions of the RoPD® system are also available for EnergyBus applications.

Benefits

- Magnetic self-mating locking mechanism interface according to Rosenberger RoPD® (European Patent No. EP1537632)
- 4 pins for data communication and 2 pins for power transmission
- 100 % self-location
- Shallow mounting depth
- Waterproof and robust
- Shock- and vibration proof
- UV-resistant
- Reliable contact pressure
- Zero-force mating
- High number of mating cycles

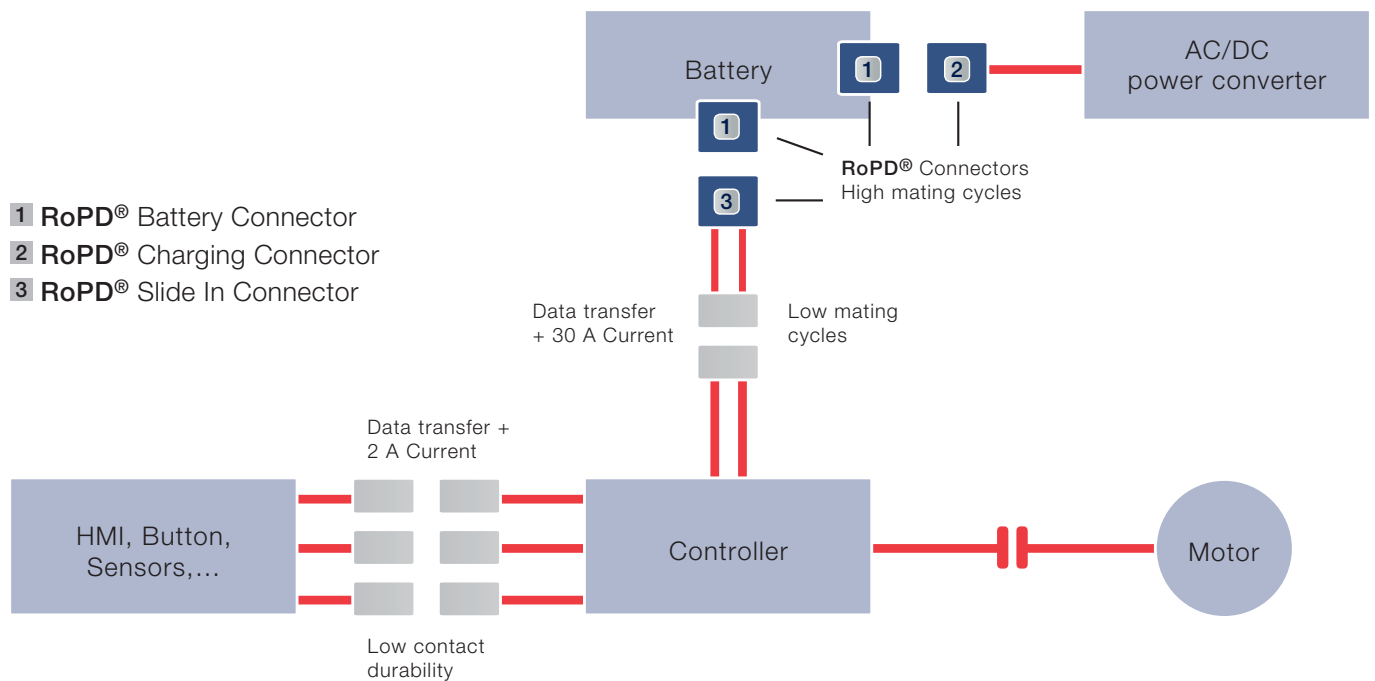

Product Portfolio

- Cable assemblies for different currents (10 A, 25 A, 30 A, 40 A) assembled with:
RoPD® charging connector jack (straight or right angle)
RoPD® battery panel plug (round or square)
RoPD® slide-in panel jack (flexibly seated)
- PCB connectors
- Protection caps

Product Features

- Current (power pins): 10 A, 25 A, 30 A, 40 A
- Voltage (power pins): up to 60 V DC
- Temperature range -40 °C to +65 °C
- Mating cycles > 2500
- Waterproof (mated connection) IP67

RoPD® Technical Data (Code M4 / C00x)

Applicable Standards

Interface according to	Rosenberger RoPD®
------------------------	-------------------

Electrical Data

Voltage (power pins)	60 V DC
Current (power pins) C001- C003- C004- C006-	10 A 25 A 30 A 40 A
Voltage (data pins)	12 V
Current (data pins)	2 A







Mechanical Data

Locking mechanism	magnetic self-mating
Mating cycles	> 2500
Power pin wire cross section C001- C003- C004- C006-	1 mm ² 2.5 mm ² 4 mm ² 6 mm ²
Mounting cut-out, male	Ø 25 mm
Mounting depth (with/without fastener ring)	20 mm

Environmental Data



Temperature range	-40 °C to +65 °C
IP class (plug unmated)	IP65
IP class (plug/jack mated)	IP67

RoPD® Cable Assemblies



Rosenberger No.	Max. Current Load	Assembly incl. Connector	
C001-04-xxx-y*	10 A	Charging connector jack straight	
C003-03-xxx-y*	25 A		
C001-08-xxx-y*	10 A	Charging connector jack right angle	
C003-04-xxx-y*	25 A		
C001-A2-xxx-y*	10 A	Slide-in panel jack straight round flange	
C003-A2-xxx-y*	25 A		
C006-A2-xxx-y*	40 A		
C001-10-xxx-y*	10 A	Slide-in panel jack straight 4-hole flange	
C003-BB-xxx-y*	25 A		
C004-BB-xx-y	30 A		
C006-BB-xxx-y*	40 A		
C001-21-xxx-y*	10 A	Battery panel plug straight round flange	
C003-17-xxx-y*	25 A		
C006-17-xxx-y*	40 A		
C001-11-xxx-y*	10 A	Battery panel plug straight 4-hole flange	
C003-B1-xxx-y*	25 A		
C004-B1-xxx-y	30 A		
C006-B1-xxx-y*	40 A		

* please fill in: xxx requested length in mm, y coding
Further or customized versions and codings on request

PCB Connectors

Rosenberger No.	Max. Current Load	Connector	Panel Piercing / PCB Layout	
M4S108-400B5-y		PCB panel straight 4-hole flange	MB 462	
M4S109-400B5-y		PCB panel round flange	MB 462	

Accessories

Rosenberger No.	Description	
M4Z003-000	Protection cap for plug connectors	
170-108-00000	Protection cap for jack connectors	

RoDC – Rosenberger Data Connector

RoDC connectors and cable assemblies are EMC protected and waterproof solutions in smallest dimensions and can be used in various LEV's, e.g. in modern e-bikes or scooters. The contact system conforms to automotive standards.

Connector Features

- RoDC connectors (plug and jack)
- Inline connection designed for EMC
- Dust and water resistance
- Vibration and shock resistance
- Cost effective
- Compact design – very low space requirements max. Ø 7 mm
- Contact system tested according to automotive standards
- Innovative snap-on system

Cable Features

- Symmetrically constructed twisted pair cable for an excellent EMC – 4 x 0.35 mm² wires
- Insulation TPE, Jacket TPU

Applications

- RoDC connectors and cable assemblies are designed especially for LEV's, e.g. e-bikes

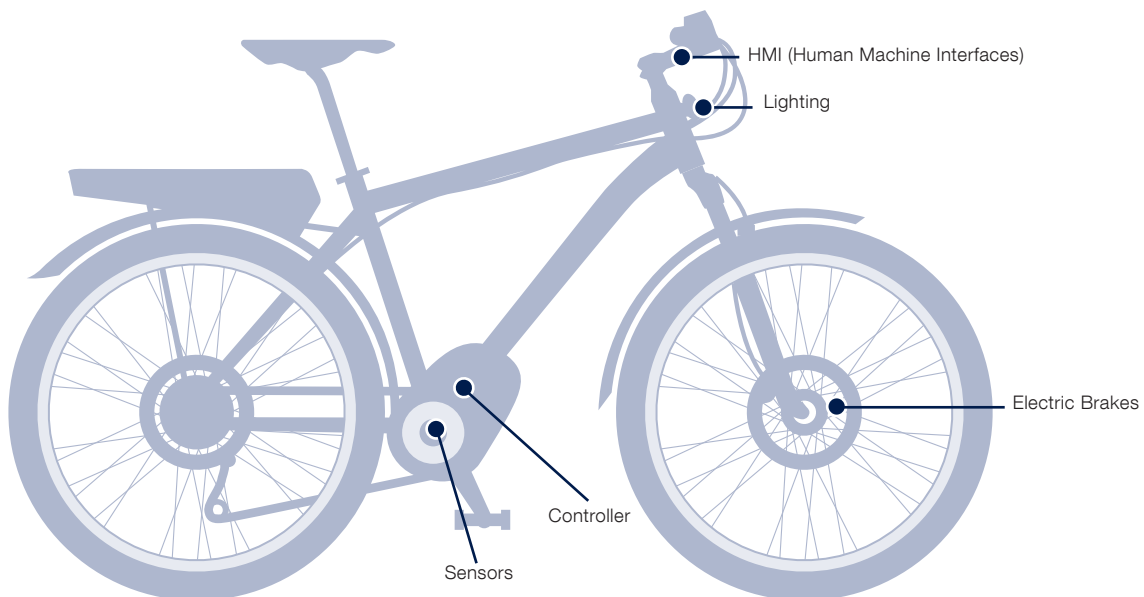

RoDC Technical Data

Applicable Standards

Interface according to	RoDC – Rosenberger Data Connector RN_082-01
------------------------	---

Electrical Data

Cable impedance	120 ± 12 Ω
Insulation resistance	≥ 1 x 10 ³ MΩ
Working voltage	12 V rms
Current capacity (per pin)	< 2 A DC

Mechanical Data

Mating cycles	> 25
Engagement force	≤ 20 N
Disengagement force	≥ 30
Locking mechanism	snap-on

Environmental Data

Temperature range	-40 °C to +65 °C
IP class (mated)	IP67
RoHS	compliant

RoDC Product Portfolio

Rosenberger No.	Description	
LAL-001-xxx*	Cable assembly 0.35 mm ² 1 x RoDC connector male	
LAL-002-xxx*	Cable assembly 0.35 mm ² 1 x RoDC connector female	
E2S102-400X5	PCB connector male	

* please fill in: xxx requested length in mm



Status January 2020 – Technical modifications and errors excepted. Similar images.



Automotive – RoPD® Website

For more information refer to our website:
www.rosenberger.com/ropd

Rosenberger

Rosenberger Hochfrequenztechnik GmbH & Co. KG

Hauptstraße 1 | 83413 Fridolfing

P.O. Box 1260 | 84526 Tittmoning

Germany

Phone +49 8684 18-0

info@rosenberger.com

www.rosenberger.com

Certified by IATF 16949 · DIN EN 9100 · ISO 9001 · ISO 14001

Order No.
pA 235482 · Info270RoPDFlyEN
2000/2020

Rosenberger® and RoPD® are registered trademarks of Rosenberger Hochfrequenztechnik GmbH & Co. KG.
All rights reserved.

© Rosenberger 2020

X-ON Electronics

Largest Supplier of Electrical and Electronic Components

Click to view similar products for [Specialised Cables category](#):

Click to view products by [Rosenberger manufacturer](#):

Other Similar products are found below :

[603PT6](#) [603SS6L](#) [604PT6](#) [604SS6](#) [706000D02F200](#) [910640](#) [1200740077](#) [1200740114](#) [AC172](#) [ACL-SSI-4](#) [R88ACAKA0015SRE](#)
[R88ACAWL005SDE](#) [R88ACRGD0R3C](#) [1300150047](#) [1300660036](#) [1302262116](#) [1300150149](#) [1300220020](#) [1300220104](#) [1300220119](#)
[1301240492](#) [1301810221](#) [1365323-1](#) [1613055](#) [176P12](#) [1971465-2](#) [20240400003](#) [20240400013](#) [2085828-1](#) [20886510030](#) [2-22733-8](#) [22733-](#)
[8](#) [CB-5PSBC-RS](#) [CB-704EC-RS](#) [CB-BATACC-RS](#) [CB-JST3PSW-RS](#) [CB-M12COM-R10](#) [25AC84](#) [25AK84X](#) [25AU25](#) [25FN82](#) [3011-03](#)
[AC118](#) [ACL-HHS-1M\(CAT5E\)](#) [SSL009PC2DC012N](#) [FC2A-KC6C](#) [2085828-2](#) [20886510150](#) [CCS-FCB-5](#) [CCSFCBF2](#)