

High-Voltage Connector Systems

AUTOMOTIVE

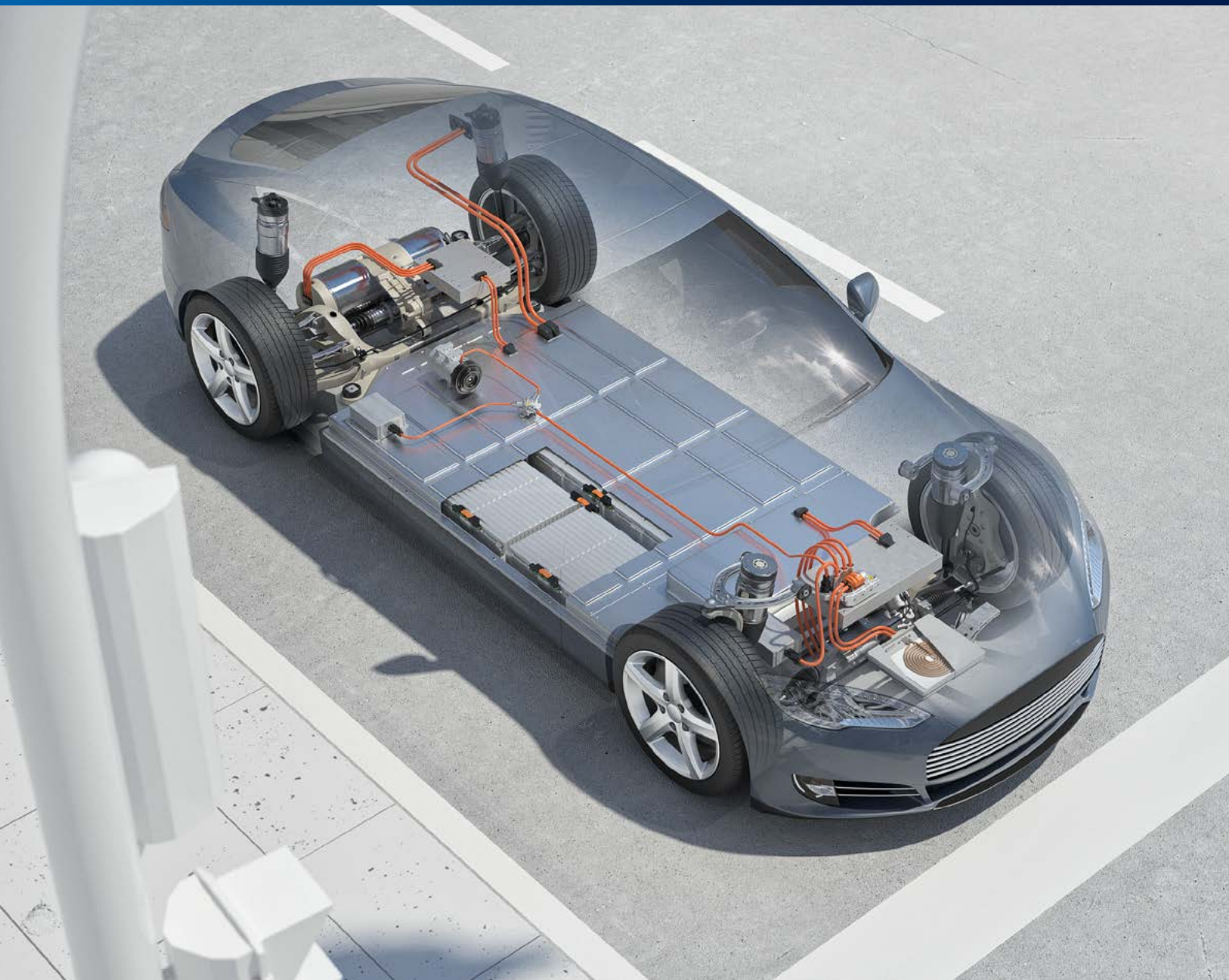



Rosenberger Automotive – a Synonym for Quality and Innovation

On the following pages we present the high-quality Rosenberger high-voltage connector systems developed in our automotive business area. They fulfill the tough requirements of the automotive industry.



Rosenberger Global Network	4
Quality & Environment	6
Competencies & Technology	8
Research & Development	10
Rosenberger Automotive	12
Rosenberger High-Voltage Product Overview	14
HV Contact Systems and Connection Technologies	16
Rosenberger High-Voltage Connector Matrix	18
Rosenberger Number Code	19
HVR®50	22
HVR®200	26
HVR®260	30
HVR®300	32
HVR®420	36
HPK	40
DCS	50
HV Fuse	54
HV Components	56
LVR®120	58

The Rosenberger online catalog contains the current Rosenberger high-voltage connector systems product range with specific details, including data sheets, assembly instructions, and panel piercings.



www.rosenberger.com/ok/hv

Rosenberger Global Network

Rosenberger is one of the world's leading manufacturers of impedance controlled and optical connectivity solutions. It provides connectivity solutions in high-frequency, high-voltage, and fiber-optic technology for mobile communication networks, data centers, test & measurement applications, automotive electronics, as well as high-voltage contact systems, medical electronics or aerospace engineering.

A global network of R&D, manufacturing and assembly locations provides innovation, optimized cost structure and excellent customer services world-wide more than 11,000 employees develop, produce and sell our products.

Contacts Automotive

Headquarters

Rosenberger

Rosenberger Hochfrequenztechnik GmbH & Co. KG
Hauptstraße 1 | 83413 Fridolfing
P.O. Box 1260 | 84526 Tittmoning
Germany
Phone +49 8684 18-0
info@rosenberger.com
www.rosenberger.com

Sales Automotive

Europe

Germany

Rosenberger Hochfrequenztechnik
GmbH & Co. KG
Hauptstraße 1
83413 Fridolfing
Germany
Phone +49-8684-18-1694
automotive@rosenberger.com

France

Rosenberger Automotive France
Actipark
17, Rue des Frères Lumière
67201 Eckbolsheim
France
Phone +33-3-90 20 76 03
Fax +33-3-90 20 76 01
automotive.france@rosenberger.com

Italy

Rosenberger Italia Srl
Via Torri Bianche 7 - Piano 7
20871 Vimercate (MI)
Italy
Phone +39-039-96 30306
info-italia@rosenberger.com

Spain

Rosenberger Telecom, S.A.
C/Lozoya nº2, nave 18 -
P.I. Ventorro del Cano
28925 Alcorcón - Madrid
Spain
Phone +34 91 352 8352
Fax +34 91 352 9813
rosenberger@rosenberger.es

Sweden

Rosenberger Sverige AB
Fågelsångsvägen 7B
186 42 Vallentuna
Sweden
Phone +46-8-6 36 26 00
Fax +46-8-6 36 26 26
info@rosenberger.se

United Kingdom

Rosenberger UK Ltd.
York House, Cottingley Business Park
Bradford, BD16 1PE
England
United Kingdom
Phone +44-7980 730423
automotive.uk@rosenberger.com

North America

USA

Rosenberger North Amerika Akron, LLC
Fairlane Office Center
4 Parklane Boulevard, Suite 307
Dearborn, MI 48126
United States of America
Phone +1-734-673 4131
Phone +1-248-259 5750
automotive.usa@rosenberger.com





The Rosenberger headquarters, located in Fridolfing in the southeast part of Bavaria, Germany, is the global center for our activities.

South America

Brazil

Rosenberger Domex Telecom Ltda.
 Cabletech Avenue, 601
 Guamirim
 CEP 12295-230
 BR-Cacapava - São Paulo
 Brazil
 Phone +55-12-3221 8500
 Fax +55-12-3221 8543
 vendas@rosenbergerdomex.com.br

Chile

Rosenberger Sudamérica Ltda.
 Aldunate 1961,
 Santiago 836-1195
 Chile
 Phone +56-2-3 67 11 70
 Fax +56-2-3 67 12 78
 rosenberger@rosenberger.cl

Asia

China, Asia, Australia

Rosenberger
 Asia Pacific Electronic Co., Ltd.
 No. 3, Anxiang Road, Block B
 Tianzhu Airport Industrial Zone
 Beijing 101300
 PR China
 Phone +86-10-80 48 19 95
 Fax +86-10-80 48 24 38
 info@rosenberger.com.cn

Japan

Rosenberger Automotive Japan, LLC.
 Sanno Mori Building 2-10-1 Nagata-Cho,
 Chiyoda-Ku
 100-0014 Tokyo
 Japan
 Phone +813 5511 2525
 automotive.japan@rosenberger.com

Korea

Rosenberger Automotive Korea
 #1104, ACE Gwanggyo Tower 3
 77, Changnyong-daero 256beon-gil,
 Yeongtong-gu, Suwon-si, Gyeonggi-do,
 16229
 Republic of Korea
 Phone +82 70 7779 2236
 Mobile +82 10 4729 6194
 automotive.korea@rosenberger.com

India

Rosenberger Electronic Co. (India) Pvt
 Limited
 Plot No. 263, Sector 6
 IMT Manesar, Gurgaon
 Haryana-122050
 India
 Phone +91-124-477 55 00
 Fax +91-124-477 55 01
 info@rosenberger.in

Quality & Environment

The quality of our products, solutions and services is an essential part of our corporate strategy.

Ensuring the optimum quality of products and services and taking responsibility for our environment are fundamental elements of Rosenberger's corporate philosophy. Our quality philosophy does not just cover the optimization of parts and products, but also the continuous improvement of all company processes: from product development, planning, procurement, production, sales, logistics right through to environmental policy. To summarize, we want to offer maximum benefits for our customers all over the world.

We aim to act in an environmentally conscious manner, use materials economically, protect natural resources, recycle, and ensure energy efficiency.

As we have continuously improved our processes and consistently applied our quality management systems, we have been awarded many certificates.

Rosenberger has won a number of prestigious quality awards and prizes from several renowned customers and organizations for implementing its quality and environmental objectives.

IMDS System

Rosenberger is registered with the IMDS system (Internationales MaterialDatenSystem der Automobilindustrie) since 2001. The products are fed systematically into the IMDS system.

www.mdsystem.com



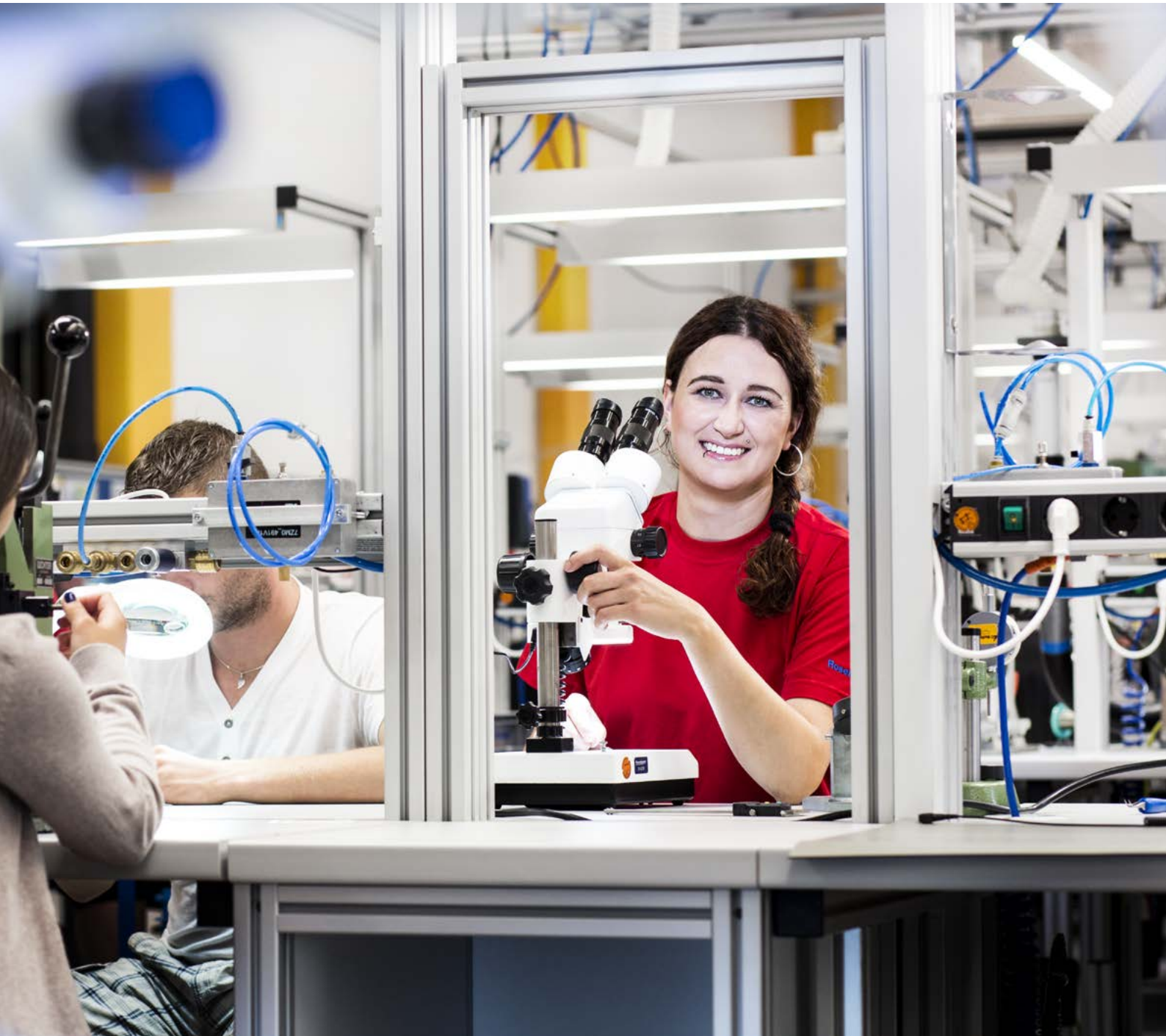

Certificates

- IATF 16949
- DIN EN 9100
- ISO 9001
- ISO 14001
- DaKKs accreditation according to DIN EN ISO 17025

Competencies & Technology

Rosenberger's mission is to be a leader when it comes to innovation and technology within its business segments.

The ongoing focus on cost management and process optimization complements our commitment to the increasingly stringent requirements for delivering products of the highest quality. Effective research & development, the very latest manufacturing technologies, the highest possible levels of efficiency in production processes, and continuous improvement of process automation make up Rosenberger's core competencies.





Research & Development

Science-based high-frequency know-how enables us to continuously improve existing products and to design innovative products and solutions whether standard or customer specific. Numerous patents are proof of Rosenberger's leadership as a creative and innovative partner.

Production

By manufacturing everything in house and using state of-the-art manufacturing technologies, Rosenberger can continue to develop and optimize key manufacturing technologies – turned parts production, stamped & formed technology, injection molding technology. Manufacturing everything in house ensures a high degree of flexibility, and continuous quality controls, and means that newly designed products can be produced in the required quantities.

Plating Technology

Our components can be electroplated quickly and flexibly in our own in-house electroplating facilities, regardless of whether this is to provide corrosion protection, optimized conductivity, or other technical and physical characteristics. Environmental protection is another key factor which must be taken into account when coating surfaces.

Assembly

Rosenberger operates manufacturing and assembly locations around the world – fully automated assembly centers and customer-oriented cable assembly locations offer global support and local sourcing.

Injection Molding

We use the very latest machinery and methods, as well as special materials and components to ensure the precision and durability of our tools and products. Rosenberger is able to process all available high-performance plastics.

Research & Development

EMC

Thanks to many years of close cooperation with automobile manufacturers in the supply of components, Rosenberger plays a major role in the EMC development process and is very familiar with the procedures for EMC tests on vehicles. In addition to this, Rosenberger has its own in-house EMC laboratory and associated measurement equipment, enabling it to conduct tests alongside development at sub-system level in relation to radiated emissions compliant with CISPR 25 and immunity to conducted disturbances, for example in accordance with ISO 11452-4 (BCI method) or ISO 11452-5 (stripline method). At component level, Rosenberger is working with Bedea as a supplier of measurement equipment for triaxial shielding measurement technology compliant with IEC 62153-4-x, and is also one of the driving forces behind the standardization of optimized and innovative measurement procedures and standards for high-voltage products. On request, we are happy to assist our customers in deriving and defining product requirements at component level.

In order to optimize the EMC behavior of HV connectors, 3D field simulation and measurement of shielding properties (feeder wire/triax method) are used as standard and therefore form an integral part of the development process.

Mechanical and Thermal Design

In order to meet the mechanical requirements, mounting and/or retaining forces of plastic housings, contact springs, seals, and crimp connections are determined virtually at an early stage. As is the case for all simulation disciplines, the measurements of the (material) parameters that have been entered are conducted in-house. When observing contact pairs in particular, studies conducted on test benches developed in-house to assess contact resistance subject to friction cycles or temperature influence provide well-founded information.

Thermal simulation approaches are then needed if brief load peaks in the electrical drivetrain cause the component to heat up. 1D simulations are generated, which determine the temperature distribution under transient currents based on standard driving cycles. As a result, the components can be operated below the limit temperatures with an acceptable level of safety.

The harness masses produced by the current carrying capacity cause dynamic loading of the connection systems. In this regard, contact fretting can permanently increase the electrical resistance under vibration. To prevent this, dynamic simulations are carried out at an early stage. Reducing the relative motion and increasing damaging resonant frequencies enhances the ruggedness of the component.

B: Variante_1
Directional Deformation
Type: Directional Deformation(X Axis)
Unit: mm
Coordinate System
Time: 2
26.10.2017 07:59

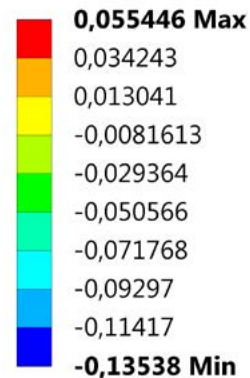

A fundamental requirement with respect to electrical contact systems in automotive applications is a robust design that fits in small spaces and works in harsh ambient conditions. In order to achieve this, Rosenberger prides itself on state-of-the-art simulation-based component development.

In close cooperation with design, process development, and quality management, calculations are made right from the concept phase in relation to temperature distribution under current load, EMC, quasi-static and dynamic mechanical behavior. In conjunction with contact physics studies on interface pairs, it is possible to make optimizations to the virtual component in order to achieve the required thresholds.

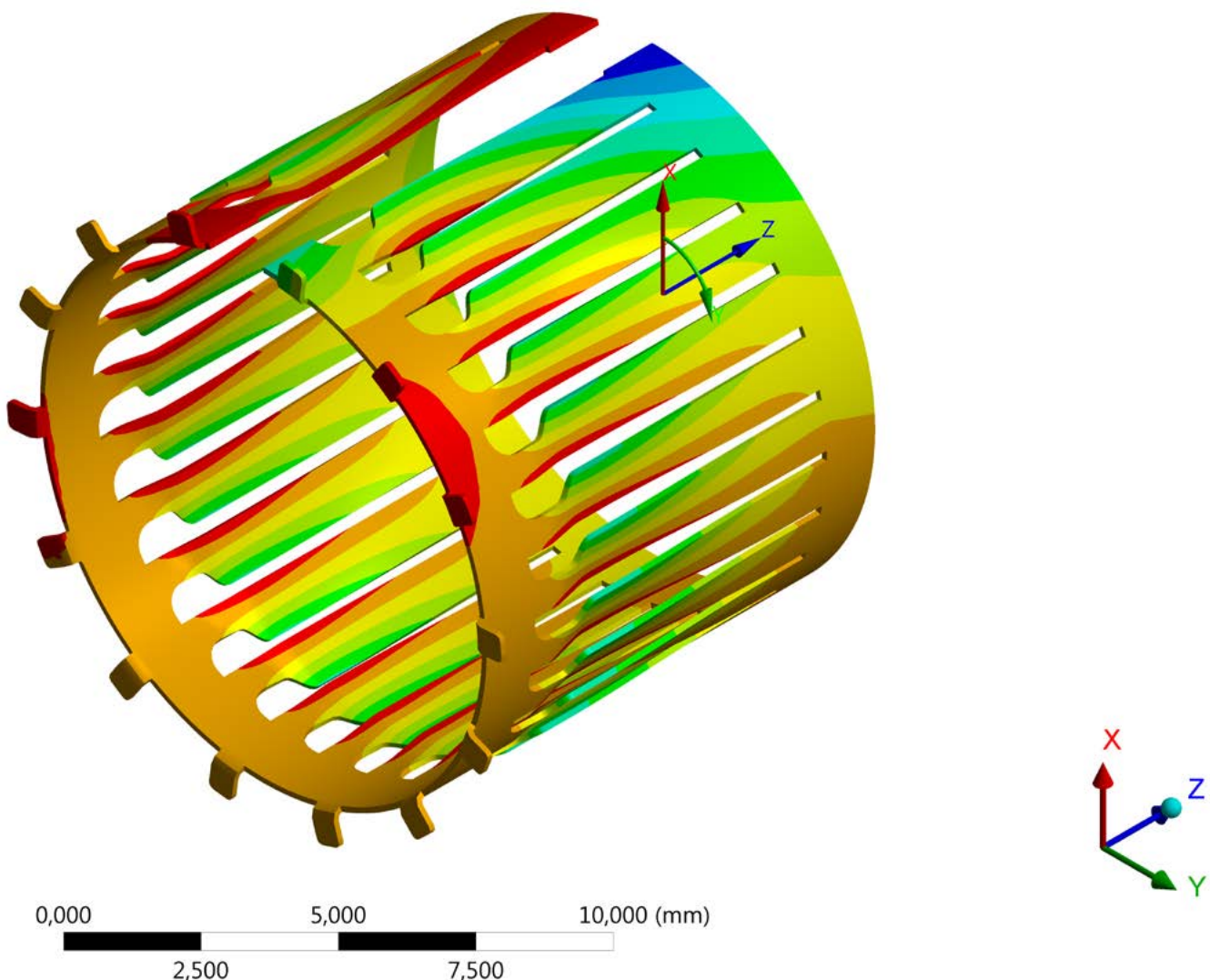

Rosenberger Automotive

At Rosenberger, we firmly believe in developing technology for the future. We are currently working on products and solutions that will shape our lives in the future.

We want to get faster and smarter in what we do and how we do it. Car driver assistance systems, connected car technology, electromobility, infotainment systems – Rosenberger is extremely committed to designing innovative connector systems for future automotive electronics.

In 2000, Rosenberger started working in the automotive sector, designing and producing customized and standard products for these specific markets.

Rosenberger Automotive is a specialist development partner when it comes to integrating connector designs and customer-specific solutions with the highest quality and best performance – while continuing to meet customer price targets.

The contact systems have been specially designed to fulfill the tough requirements of the automotive industry. From the beginning, Rosenberger has developed a close and open relationship with its customers.

The priority in the most automotive applications, such as autonomous driving and driver assistance systems, is to ensure safety. It is necessary to determine exact positions, continuously calculate routes, and detect and classify objects. High data volumes from several cameras, various sensors, and navigation sources must be combined and transported for this purpose – in real time.

Application Areas

- Autonomous driving
- Driver assistance systems
- Navigation
- Infotainment
- Fond-entertainment
- Internet & mobile communication
- Next generation WLAN: "WiGig" (Wireless Gigabit)



Rosenberger High-Voltage Technology

Rosenberger fully recognizes the ongoing shift from combustion engines towards hybrid and electric motors in vehicles calls for continual innovation in connector technology. At the same time, efficient and environmentally-friendly production methods are an absolute priority. There are many design and technical factors to be considered, not least the motor and charging performance levels required.

Electrical components must not only be robust and as space-saving as possible, but also capable of safe operation at extreme voltages and currents. From the outset, therefore, Rosenberger's primary product development goal has been to deliver the lowest possible contact resistances with optimized EMI performance characteristics.

Our HV range includes highly compact connection solutions which can be operated up to 1000 V at continuous currents of up to 450 A over product lifetimes.

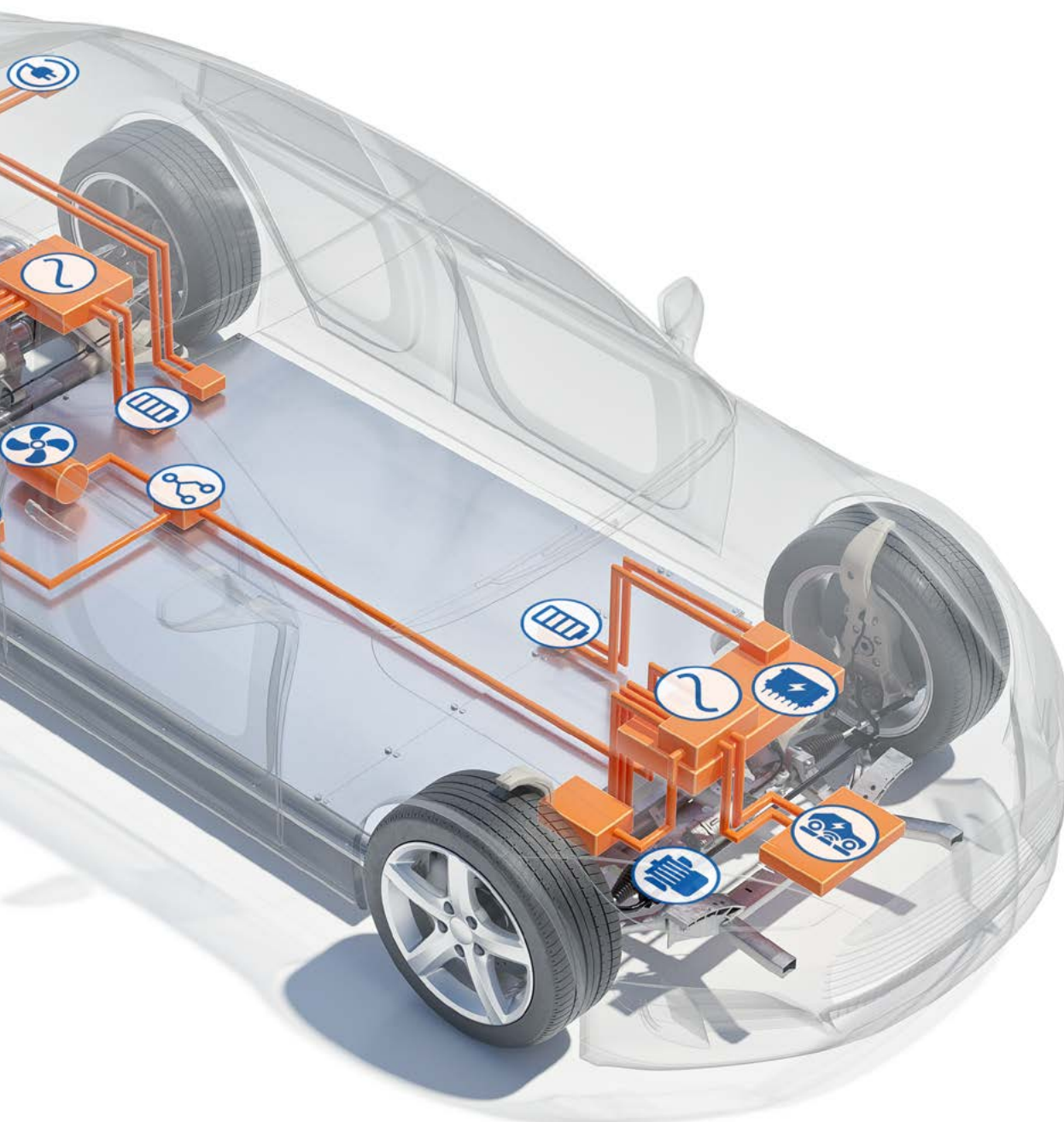

Rosenberger High-Voltage Product Overview

Developed especially for optimized power transmission in electric and hybrid vehicles, the extensive portfolio of Rosenberger high-voltage connector products is designed to meet customer requirements for maximum quality, reliability, performance, and price competitiveness.

Up to 50 A and 450 A current loads from 2 x 4 mm² to 120 mm² cable diameters can be supported, as well as power distribution units for customer-specific assemblies.

When electrical power transmission performance really counts Rosenberger has the perfect connection.

High-Voltage Portfolio

- High-voltage connectors (HVR series)
- High-power connectors (HPK series)
- Direct contact systems (DCS series)
- HV components (power distribution units, splitters, cell modules, fuses)
- Low-voltage connectors (LVR series)

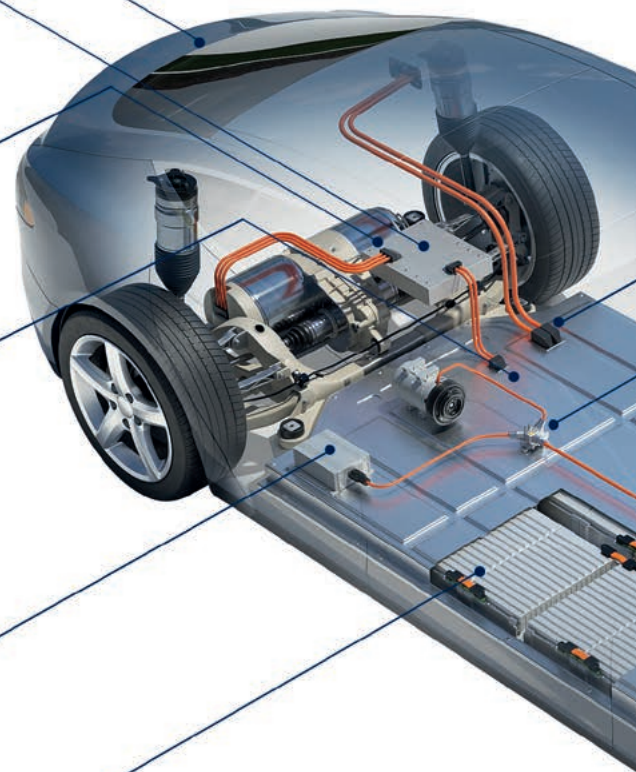
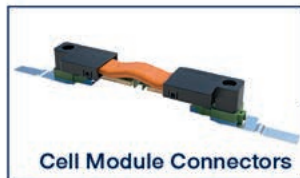

Technical Advantages and Core Competencies

- High current performance
 - Minimum installation space
 - Highest vibration classes
 - Simulation
 - Contact system and connecting technology
 - Assembly
- Best EMI performance after aging due to silver plated contacts and special screwing technology
 - Easy assembly process 100 % defined. Detailed assembly instruction for cable side and unit side (copper & aluminum)
 - Standard requirements according to German OEM standard LV215 and to US OEM standard USCAR

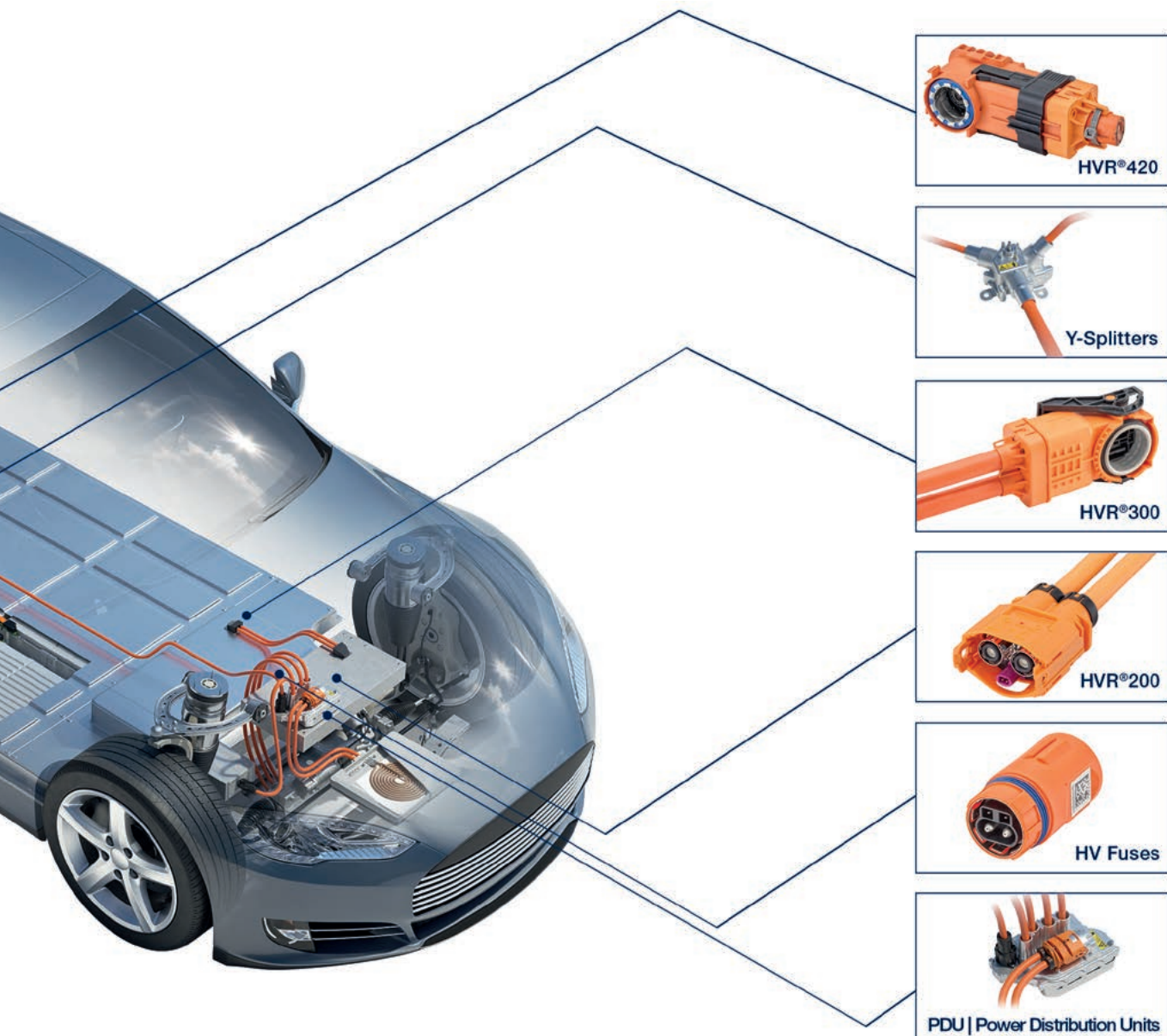

HV Contact Systems and Connection Technologies

Contact Systems

The Rosenberger high-voltage connection and accessory portfolio is based on different contact systems.

The following contact systems are available:

Spring leaf technology



Stamped sleeve technology



Surface contact technology



Each technology enables multiple contact points to achieve the lowest possible contact resistances and highest current performance. Depending on your application, Rosenberger can use the most suitable contact technology to fulfill your requirements. Our contact technologies ensure constant contact forces over a wide range of use cases. Large mating tolerances and temperature changes can be compensated without significant deviation from the initial specification.

Even after severe aging, the Rosenberger silver-plated contact pins and "press-in sleeves" ensure optimum current carrying capacity as well as EMI performance over the product's lifetime. Especially in comparison with alternative contact methods with nickel-plated or cast material, the Rosenberger "press-in sleeve" ensures stable shielding performance of the highest caliber. Due to the multiple contact points with both sides on inner and outer connection diameters, vibration levels up to severity level 4 can be achieved.

Performance

- High current capacity
- Low contact resistance
- Low mating force

Further Product Advantages

- High number of contact points
- Controllable/adjustable contact forces
- Small diameters and cross sections available
- Minimal self-heating
- Simple assembly
- Small space requirements
- For static, gliding and rotating connections
- High tolerance range for assembled components and low production costs

Connection Technologies

Rosenberger uses two different methods to create secure electrical and mechanical connections: crimp connection and ultrasonic welding, which fulfill highest automotive quality standards. Each connection technology is standardized by automotive harness makers.

Crimp Connection

The crimping method is an important connection technique for connectors at Rosenberger. This process involves the physical compression of a contact or a contact sleeve around a stranded wire in order to produce a reliable and long-lasting electrical connection. In the case of crimped contacts, a second crimp is often added in the insulation area in order to provide strain relief.

Prefabricated conductor sleeves or insulating sleeves are crimped around a stranded wire to form a connection that is difficult to detach. This process ensures a high-quality electrical and mechanical connection which is also gas-tight.

The crimping process is developed and refined in Rosenberger's own laboratories. In order to reduce the product introduction time for the customer, the relevant parameters and tools are defined as part of this process and made available in the installation instructions.

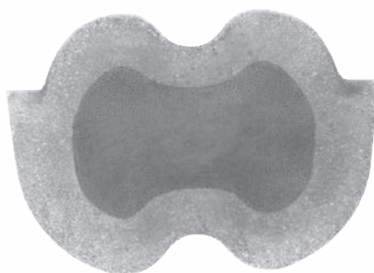

Ultrasonic Welding

Ultrasonic welding involves generating high-frequency alternating current using a generator. This current is transferred to a converter which turns it into mechanical ultrasonic vibrations. The vibrations of the welding electrode heat up the edges of the materials being joined so that they can be fixed together permanently.

This method is characterized by very short welding times and high cost-effectiveness. Ultrasonic welding can be used to join together metals such as copper and aluminum. The main focus at Rosenberger is on metal joining techniques where, for example, copper or aluminum stranded wires are welded together with an internal conductor.

The connection pairings developed by Rosenberger are carefully tested in the company's own laboratories in order to verify a huge range of physical variables in accordance with the relevant automotive standards or customer requirements.

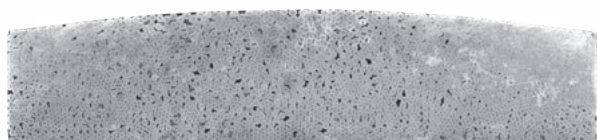

Rosenberger High-Voltage Connector Matrix

Series	Jack/ Plug	Right Angle	Straight	1-Pole	2-Pole	3-Pole	Max. Current at 85 °C	Cable Cross Sections [mm ²]	Cable Connector
HVR®50	Jack	✓	✓	n.a.	✓	n.a.	60 A	4, 6	
	Plug	n.a.	✓						
HVR®200	Jack	n.a.	✓	n.a.	✓	n.a.	210 A	16, 35	
	Plug	✓	✓						
HVR®260	Jack	✓	n.a.	n.a.	n.a.	✓	270 A	50, 70	
	Plug	n.a.	✓						
HVR®300	Jack	✓	n.a.	n.a.	✓	n.a.	320 A	50 on request, 70	
	Plug	n.a.	✓						
HVR®420	Jack	✓	n.a.	✓	n.a.	n.a.	450 A	35, 70, 95; 120 on request	
	Plug	n.a.	✓						
HPK	Jack	✓	✓	✓	✓	n.a.	275 A	16, 25, 35, 50	
	Plug	n.a.	✓						
DCS	Jack	n.a.	✓	✓	n.a.	n.a.	340 A	35, 50, 70	
	Plug	n.a.	✓						
LVR®120	Jack	✓	n.a.	n.a.	✓	n.a.	120 A	16	
	Plug	n.a.	✓						

Rosenberger Number Code

HV Connectors

H2	K	1	01-	W	2	A	035	B1	-A
									Coding
									Plating
									Cable size specified in mm ²
									Cable group
									Number of center contacts
									Backend type
									0 screw version outer and center contact
									1 crimped outer and center contact
									2 mated outer contact – screwed center contact
									5 press-fitted outer contact – crimped center contact
									9 special types
									V crimped outer contact – crimp-welded center contact
									W crimped outer contact – welded center contact
									Successive number
									Configuration
									1 straight
									2 right angle
									Gender
									K jack
									S plug
									Connector series
									H2 HVR®200
									H3 HVR®260
									H4 HPK
									H5 LVR®120
									H6 HVR®50
									H9 DCS
									HA HVR®420
									HK HVR®300

Rosenberger Number Code

HV Device Socket (Header)

HV	L	1	02-	5	B-	002	B1	-A
								Coding
							Plating	
							Successive number	
							Cable dimension	
							0 no cable	
							A 2.5 mm ²	
							B 4 mm ²	
							C 6 mm ²	
							D 16 mm ²	
							E 25 mm ²	
							F 35 mm ²	
							G 50 mm ²	
							H 70 mm ²	
							J 90 mm ²	
							Backend type	
							Successive number	
							Configuration	
							1 straight	
							2 right angle	
							Header plug with cable	
							Connector series	
							H2 HVR®200	
							H3 HVR®260	
							H4 HPK	
							H5 LVR®120	
							H6 HVR®50	
							H9 DCS	
							HA HVR®420	
							HK HVR®300	

Rosenberger Number Code

HV Fuse

H1	K	1	01-	2	2	S	PC0	B1	-A
									Coding LF-ampere rating
									A 10 A
									B 15 A
									C 20 A
									D 30 A
									E 40 A
									Plating
									PC PEC (automotive EV-fuse)
									LF little fuse (LC HEV-fuse)
									S fuse
									Number of center contacts
									Backend type
									Successive number
									Configuration
									1 straight
									2 right angle
									Gender (connector type)
									K jack
									S plug
Connector series									
H1 HV Fuse									

HVR®50

Rosenberger HVR®50 connectors are available in straight and angled variants. The additional slide locking mechanism (CPA – Connector Position Assurance) prevents accidental disconnection. Despite their small size these connectors achieve a current capacity of approximately 60 A at 85 °C. HVR®50 connectors are mainly used in ancillary units such as electrical heating systems, air-conditioning units, DC/DC converters, and for charging batteries.

Technical Properties

- Current capacity (6 mm²): 60 A at 85 °C
- Working voltage 1000 V DC, test voltage 2700 V DC
- Temperature range from -40 °C to +140 °C
- IP class mated acc. to IP6K9K / IPX8 / IPXXD
- IP class unmated acc. to IPXXB
- Vibration class acc. to LV215 PG17-II
- Mating cycles ≥ 50
- Cross sections 4 mm², 6 mm²

Applications

- Electrical heater
- Electrical air condition
- Battery charger
- DC/DC converters

Cables

- FHLR2G2GCB2G 4 mm² / 0.31 mm / LV216-2
- FHLR2G2GCB2G 6 mm² / 0.31 mm / LV216-2
- FHLR2GCB2G 6 mm² / 0.31 / LV216-2

Features and Benefits

- Minimal dimensions
- Excellent shielding
- With HVIL
- Straight and right angle cable connectors, header



Coding HVR®50

Coding	Slider Jack Color/RAL-No. (Similar)	Jack	Plug
A	Black/ 2005		
B	White/ 9010		
C	Blue/ 5012		
D	Violet/ 4004		
E	Green/ 6017		
F	Brown/ 8011		
Z	Waterblue/ 5021		

Colors of the plastic housings are in accordance with the listed RAL colors, minor color differences during manufacturing are possible.

Interface Dimensions HVR[®]50 (Code H6)

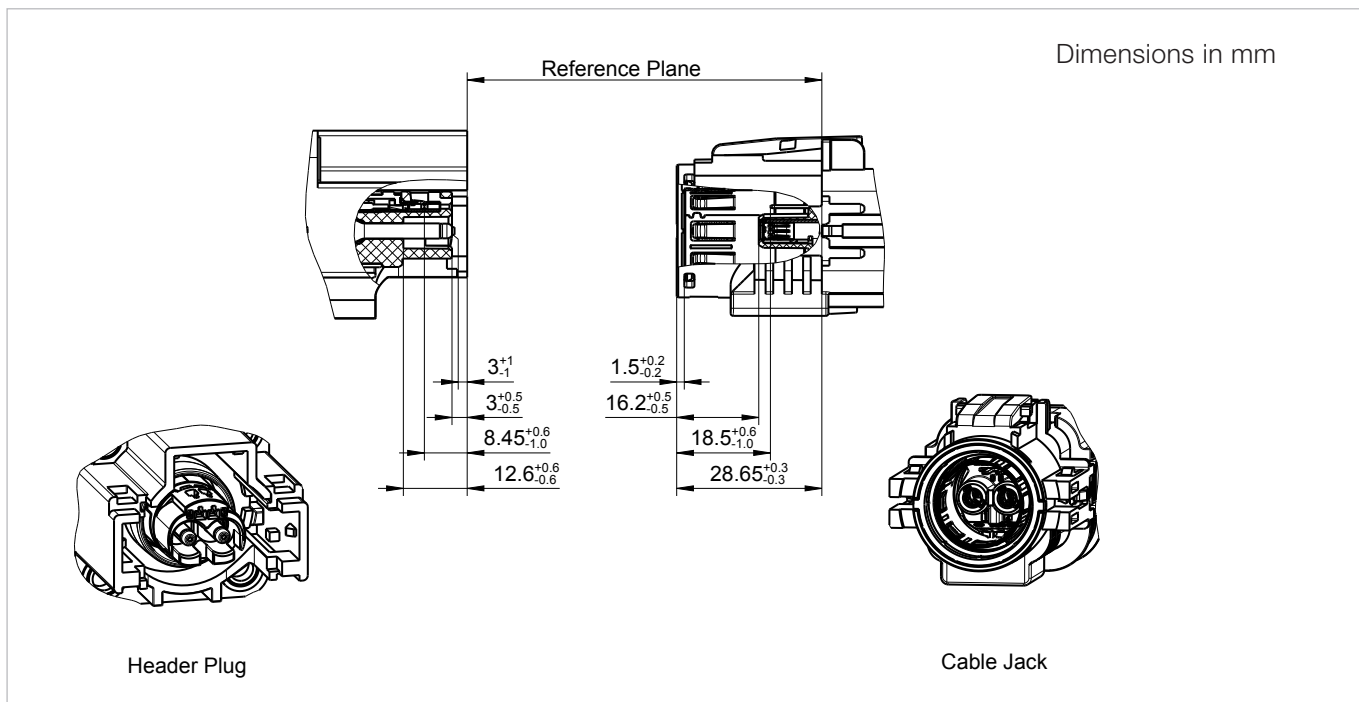

Derating Graph HVR[®]50 acc. to DIN EN 60512-5-2

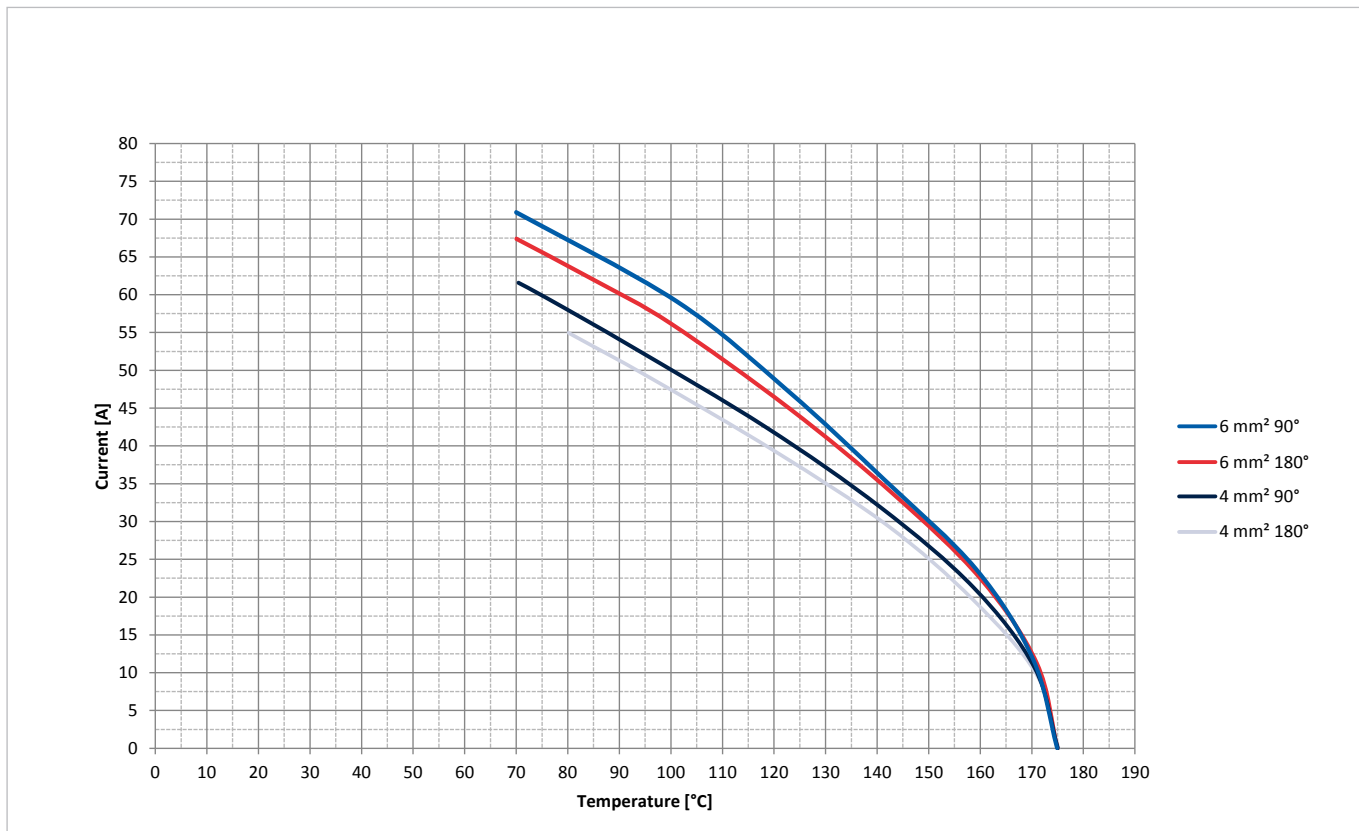

Technical Data HVR[®]50 (Code H6)

Applicable Standards

Interface according to	Rosenberger RN_111-01
------------------------	-----------------------

Electrical Data

Insulation resistance	≥ 200 MΩ at 1000 V DC
Voltage class	B 60 V DC < U ≤ 1500 V DC 30 V AC < U ≤ 1000 V AC
Center contact resistance	≤ 1.36 mΩ
Outer contact resistance	≤ 10 mΩ
Current capacity for 6 mm ²	60 A at 85 °C
Test voltage	2700 V DC
Working voltage	1000 V DC
High-Voltage Interlock (HVIL)	yes Power pins min. 1 mm advanced

Mechanical Data

Mating cycles	≥ 50
Engagement force	≤ 75 N
Coding efficiency	≥ 300 N
Cable cross sections	4 mm ² , 6 mm ²
Cable connection angle	90°, 180°
Vibration class	LV215 PG17-II
IP class (mated)	IP6K9K / IPX8 / IPXXD
IP class (unmated)	IPXXB







Environmental Data

Temperature range	-40 °C to +140 °C
RoHS	compliant

Rosenberger connectors fulfill in principle the indicated data of the technical data. Individual values of connectors may deviate depending upon application, design, type of cable, assembly method and execution. Specific data sheets for particular products can be provided on request from your Rosenberger sales partner.

Products

HVR®50 Cable Jack

Rosenberger No.	Description	Max. Current at 85 °C	Cable Cross Section	Assembly Instruction	Product
H6K106-12A004B1-Y	Straight jack 2-pole waterproof	50 A	4 mm ²	MA_HV0078	
H6K106-12A006B1-Y		60 A	6 mm ²	MA_HV0078	
H6K107-12A006B1-Y	Straight jack 2-pole waterproof 2 x single cable On request	60 A	6 mm ²	On request	
H6K105-12A006B-Y	Straght jack 2-pole dummy				
H6K206-12A004B1-Y	Right angle jack 2-pole waterproof	50 A	4 mm ²	MA_HV0077	
H6K206-12A006B1-Y		60 A	6 mm ²	MA_HV0077	
H6K207-12A006-B1-Y	Right angle jack 2-pole waterproof 2 x single cable On request	60 A	6 mm ²	MA_HV0096	
H6K205-12A006B-Y	Right angle jack 2-pole dummy				

HVR®50 Header Plug

Rosenberger No.	Description	Panel Piercing	Assembly Instruction	Product
H6L106-5B-001B1-Y	Straight plug 2-pole for H6K106, H6K206	MB_647	MA_HV0080	
H6L106-5C-001B1-Y			MA_HV0080	

-Y please fill in requested coding

HVR[®]200

Rosenberger HVR[®]200 connectors offer an excellent dimension/performance ratio, combining high current carrying capacity of 210 A at 85 °C while keeping dimensions to a minimum. These two-pin connectors are ideal for connecting elements between a battery and an inverter, or for installation in power distribution units (PDU). To suit the relevant installation or usage requirements, the portfolio includes an angled or straight header as well as a straight cable coupler.

Technical Properties

- Current capacity (35 mm²): 210 A at 85 °C
- Working voltage 750 V DC, test voltage 2700 V DC
- Temperature range from -40 °C to +140 °C
- IP class mated acc. to IP6K9K / IPX8 / IPXXD
- IP class unmated acc. to IPXXB
- Vibration class acc. to LV215 PG17-II
- Mating cycles ≥ 50
- Cross sections 16 mm², 35 mm²

Features and Benefits

- Superior dimension-performance ratio
- With HVIL
- Cable connectors and header

Applications

- Battery connection
- BDU
- Inverter

Cables

- FHLR2GCB2G 16 mm² / 0.21 mm
- FHLR2GCB2G 35 mm² / 0.21 mm



Coding HVR[®]200

Coding	Color/RAL-No. (Similar)		Jack	Plug
A	Black/ 9005			
B	White/ 9010			
C	Blue/ 5012			
Z	Waterblue/ 5021			

Colors of the plastic housings are in accordance with the listed RAL colors, minor color differences during manufacturing are possible.

Interface Dimensions HVR®200 (Code H2)

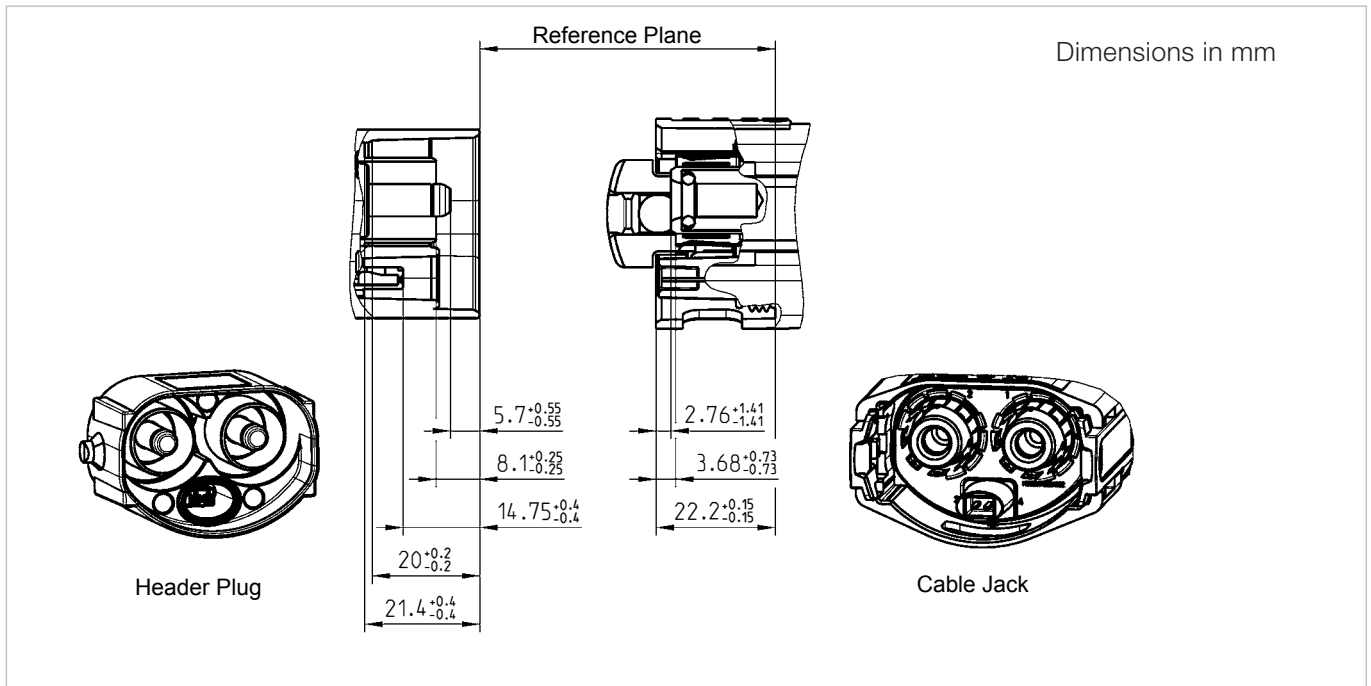

Derating Graph HVR®200 acc. to DIN EN 60512-5-2

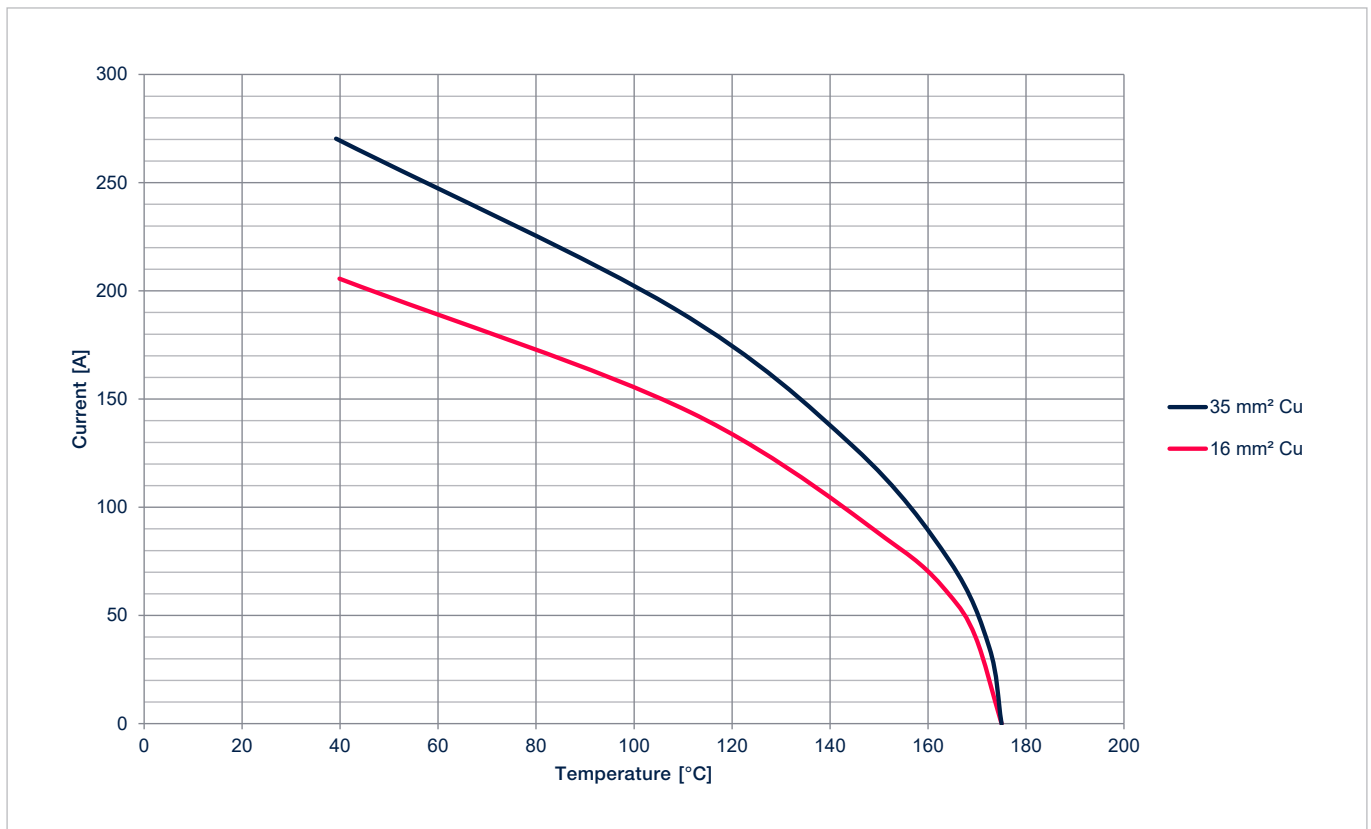

Technical Data HVR®200 (Code H2)

Applicable Standards

Interface according to	Rosenberger RN_081-01 Rosenberger RN_087-01 Rosenberger RN_087-03
------------------------	---

Electrical Data

Insulation resistance	≥ 200 MΩ
Voltage class	B 60 V DC < U ≤ 1500 V DC
Center contact resistance	≤ 0.78 mΩ
Outer contact resistance	≤ 10 mΩ
Current capacity for 35 mm ²	210 A at 85 °C
Test voltage	2700 V DC
Working voltage	750 V DC
High-Voltage Interlock (HVIL)	yes power pins min. 1 mm advanced

Mechanical Data

Mating cycles	≥ 50
Engagement force	< 75 N
Coding efficiency	300 N
Cable cross sections	16 mm ² , 25 mm ² , 35 mm ²
Cable connection angle	180°
Vibration class	LV215 PG17-II
IP class (mated)	IP6K9K / IPXXD / IPX8
IP class (unmated)	IPXXB



Environmental Data

Temperature range	-40 °C to +140 °C
RoHS	compliant



Rosenberger connectors fulfill in principle the indicated data of the technical data. Individual values of connectors may deviate depending upon application, design, type of cable, assembly method and execution. Specific data sheets for particular products can be provided on request from your Rosenberger sales partner.

Products

HVR®200 Cable Jack

Rosenberger No.	Description	Max. Current at 85 °C	Cable Cross Section	Assembly Instruction	Product
H2K101-W2A016B1-Y	Straight jack 2-pole Waterproof	150 A	16 mm ²	MA_HV0005	
H2K101-W2A035B1-Y	Straight jack 2-pole Waterproof	210 A	35 mm ²	MA_HV0005	
170-099-00005	Protection cap jack for H2K101-W2AxxxB1-Y *xxx cable size				

HVR®200 Header Plug

Rosenberger No.	Description	Panel Piercing	Assembly Instruction	Product
H2S104-02-000B1-Y	Straight plug 2-pole Waterproof	MB_448	MA_HV0017	
H2S207-02-000B1-Y	Right angle plug 2-pole Waterproof	MB_448	MA_HV0017	

-Y please fill in requested coding

HVR[®]260

The 3-pole HVR[®]260 connector system for collective shield applications is used to connect electric motors up to a continuous current of 270 A. Despite its lightweight aluminum housing it is capable of operating safely at extreme temperature ranges from -40 °C to +150 °C. It is certified to vibration severity level IV. Customer-specific variants are available on request.

Technical Properties

- Current capacity (50 mm²): 270 A at 85 °C
- Working voltage 850 V DC
- Voltage class HV-2B
- Temperature range from -40 °C to +150 °C
- IP class mated acc. to IP6K9K / IPX8 / IPXXD
- IP class unmated acc. to IPXXB
- Vibration class acc. to LV215 PG17-IV
- Maximum operation altitude 5500 m sealevel
- Contact resistance ≤ 0.26 mΩ
- Mating cycles ≥ 50
- Cross sections 50 mm², 70 mm²

Features and Benefits

- RoHS: compliant
- Qualification: according to LV214
- Right angle connector
- 3-pole connector

Applications

- E-motor
- Customer specific solutions on request

Interface Dimensions HVR®260 (Code H3)

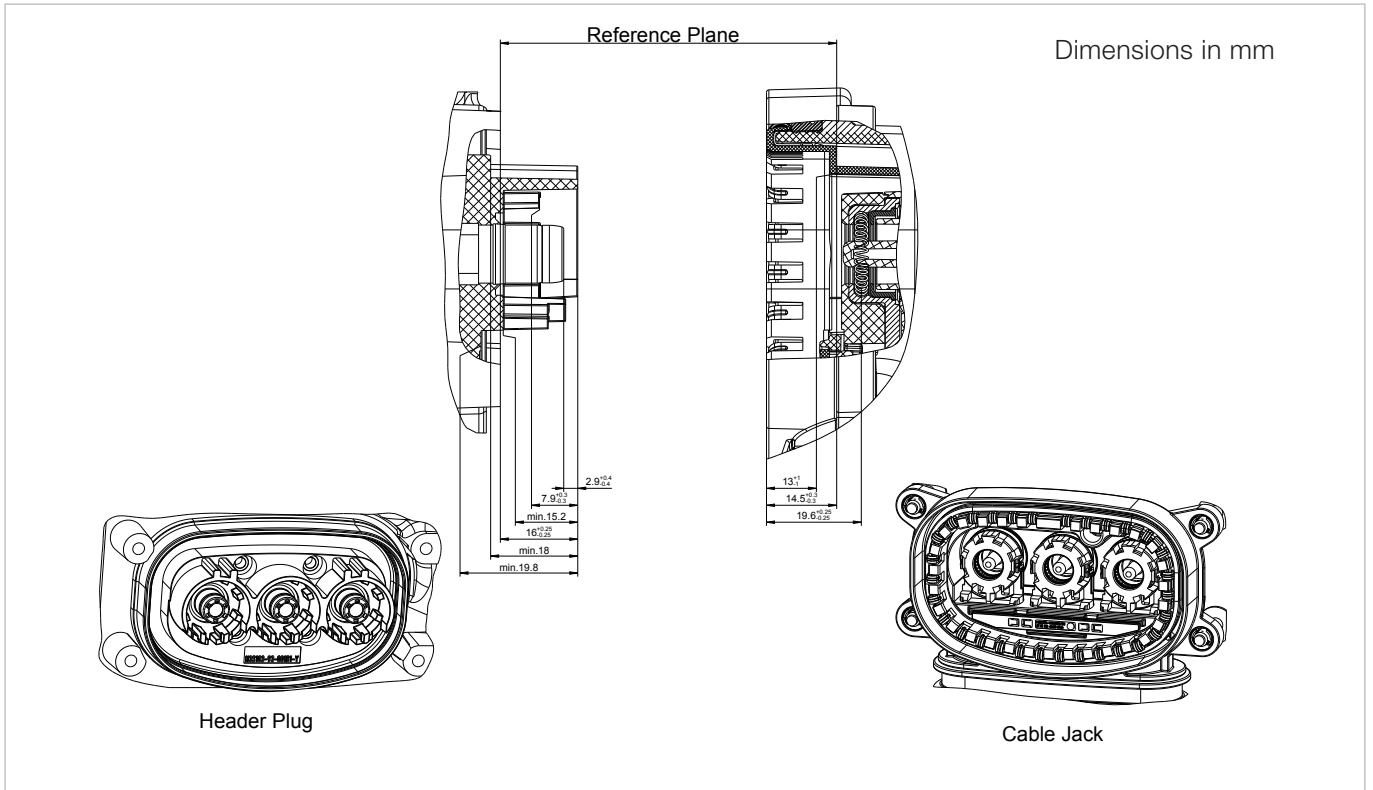

HVR®260 Header Plug

HVR®260 Cable Jack

HVR[®]300

The Rosenberger HVR[®]300 connector system not only provides a maximum current carrying capacity of 320 A, it takes up minimal space. It features a 2-pole angled coupler for shielded cables and a cable cross section of 70 mm² along with the corresponding header. A cross section of 50 mm² is available on request. The lever locking mechanism is secured with an additional slider (CPA – Connector Position Assurance) to prevent accidental unmating.

Technical Properties

- Current capacity (70 mm²): 320 A at 85 °C
- Working voltage 1000 V DC
- Test voltage 4800 V DC
- Temperature range from -40 °C to +85 °C
- IP class mated acc. to IP6K9K / IP6K6K / IP6K7
- Vibration class acc. to LV124-II
- Mating cycles ≥ 50
- Cross sections 70 mm², (50 mm² on request)

Features and Benefits

- Effective dimension – performance ratio
- With HVIL
- Right angle connector, header

Applications











- High current capacity applications
- Customer specific solutions on request

Cables

- FHLR2GCB2G / 70 mm² / 0.21 mm



Coding HVR®300

Coding	Jack	Plug
A		
B		
C		
D		
Z		

Colors of the plastic housings are in accordance with the listed RAL colors, minor color differences during manufacturing are possible.

Thermal Simulated Derating Graph HVR®300 acc. to DIN EN 60512-5-2

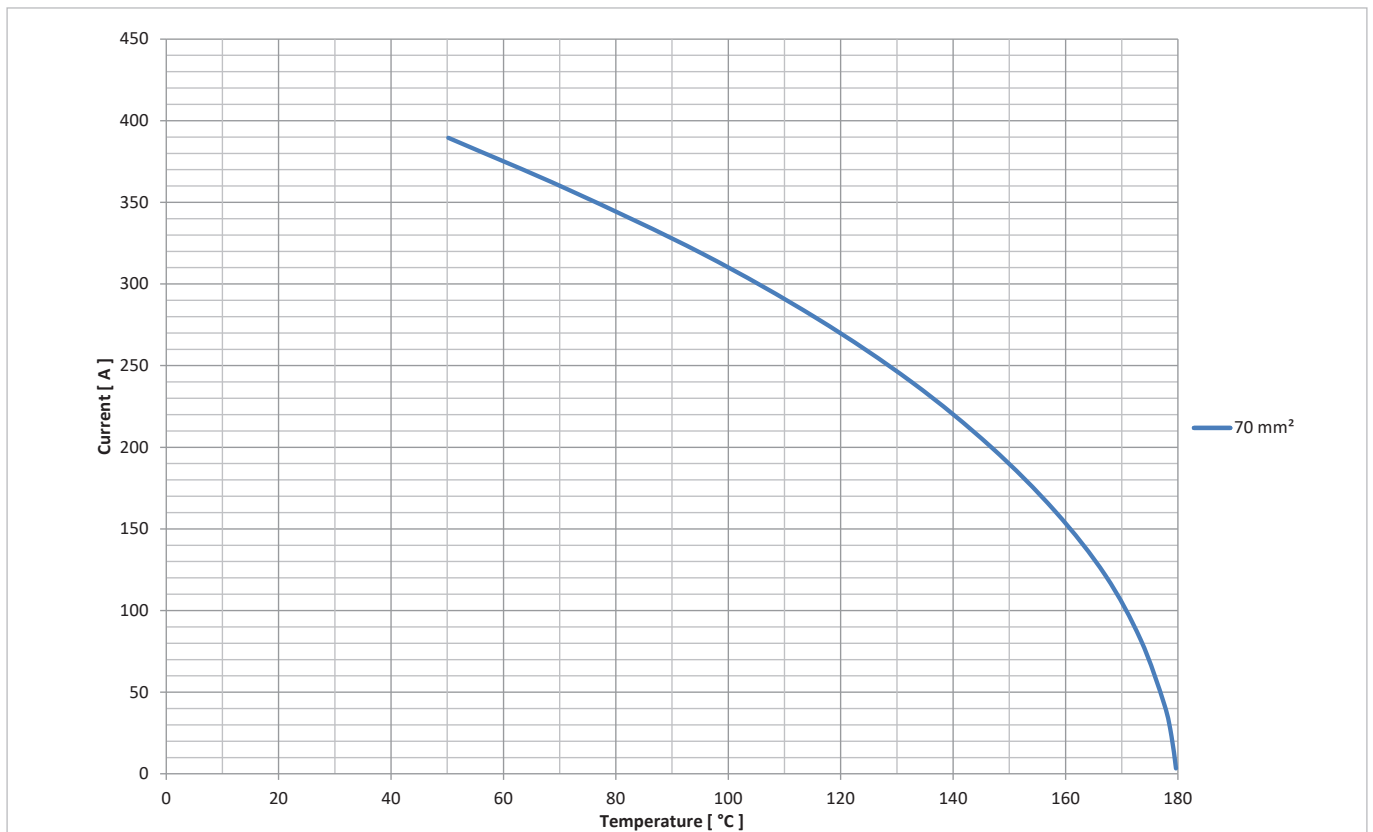

Technical Data HVR®300 (Code HK)

Applicable Standards

Interface according to	RN_140-02
------------------------	-----------

Electrical Data

Insulation resistance	≥ 200 MΩ at 1000 V DC
Voltage class	B 60 V DC < U ≤ 1500 V DC
Center contact resistance	≤ 0.12 mΩ
Outer contact resistance	≤ 2.00 mΩ
Current capacity for 70 mm ²	320 A at 85 °C (Cu-Cable)
Test voltage	4800 V DC
Working voltage	1000 V DC
High-Voltage Interlock (HVIL)	yes

Mechanical Data

Mating cycles	≥ 50
Engagement force	≤ 75 N
Coding efficiency	≥ 300 N
Cable cross sections	50 mm ² on request, 70 mm ²
Cable connection angle	90°, 180° on request
Vibration class	according to LV124-II
IP class (mated)	IP6K9K / IP6K6K / IP6K7

Environmental Data

Temperature range	-40 °C to +85 °C
RoHS	compliant

Rosenberger connectors fulfill in principle the indicated data of the technical data. Individual values of connectors may deviate depending upon application, design, type of cable, assembly method and execution. Specific data sheets for particular products can be provided on request from your Rosenberger sales partner.

Products

HVR®300 Cable Jack

Rosenberger No.	Description	Max. Current at 85 °C	Cable Cross Section	Assembly Instruction	Product
HKK204-W20070B1-Y	Right angle jack 2-pole With HVIL On request	320 A	70 mm ²	MA_HV0108	

HVR®300 Header Plug

Rosenberger No.	Description	Panel Piercing	Product
HKS109-22-000B1-Y	Straight plug 2-pole Outgoing busbar right Expanded pinning 66.4 mm, 58.9 mm, 54.4 mm	MB_721 RN_140-03	
HKS110-22-000B1-Y	Straight plug 2-pole Outgoing busbar left Expanded pinning 66.4 mm, 58.9 mm, 54.4 mm		
HKS112-22-000B1-Y	Straight plug 2-pole Outgoing busbar right Pinning: 63.4 mm, 58.9 mm, 54.4 mm On request	MB_753 RN_140-01	
HKS113-22-000B1-Y	Straight plug 2-pole Outgoing busbar left Pinning: 63.4 mm, 58.9 mm, 54.4 mm On request		

-Y please fill in requested coding

HVR[®]420

Highly compact, HVR[®]420 connectors offer the highest current carrying capacity in the Rosenberger product portfolio. Even the 95 mm² variant safely enables current transmission of 420 A while up to 450 A can be achieved at 85 °C with the largest cable cross section of 120 mm² on request. Furthermore, the additional slide locking mechanism (CPA – Connector Position Assurance) prevents accidental disconnection. Typical applications include supercharging electric vehicle batteries up to 450 kWh.

Technical Properties

- Current capacity (120 mm²): 450 A at 85 °C
- Working voltage 1000 V DC
- Test voltage 2500 V DC
- IP class mated acc. to IP6K9K / IPX8
- IP class unmated acc. to IPXXB
- Vibration class acc. to LV215 PG17-II
- Mating cycles ≥ 50
- Cross sections 35 mm², 70 mm², 95 mm² (120 mm² on request)
- Double header in design (test voltage 4300 V DC)

Applications

- Charging and supercharging unit for E-car application

Cables

- FLR2GCB2G / 35 mm² / 0.21 mm / LV216-2
- FHLR2GCB2G / 70 mm² / 0.21 mm / LV216-2
- FHLR2GCB2G / 95 mm² / 0.21 mm / LV216-2
- FHLR2GCB2G / 120 mm² / 0.21 mm / LV216-2 (on request)

Features and Benefits

- Highest performance up to 450 A
- With HVIL
- Right angle connector, header



Coding HVR[®]420

Coding	Slider Jack Color/RAL-No. (Similar)	Jack	Plug
A	Black/ 9005		
B	White/ 9010		
C	Blue/ 5012		
D	Violet/ 4004		
E	Green/ 6017		
F	Brown/ 8011		



Colors of the plastic housings are in accordance with the listed RAL colors, minor color differences during manufacturing are possible.

Interface Dimensions HVR®420 (Code HA)

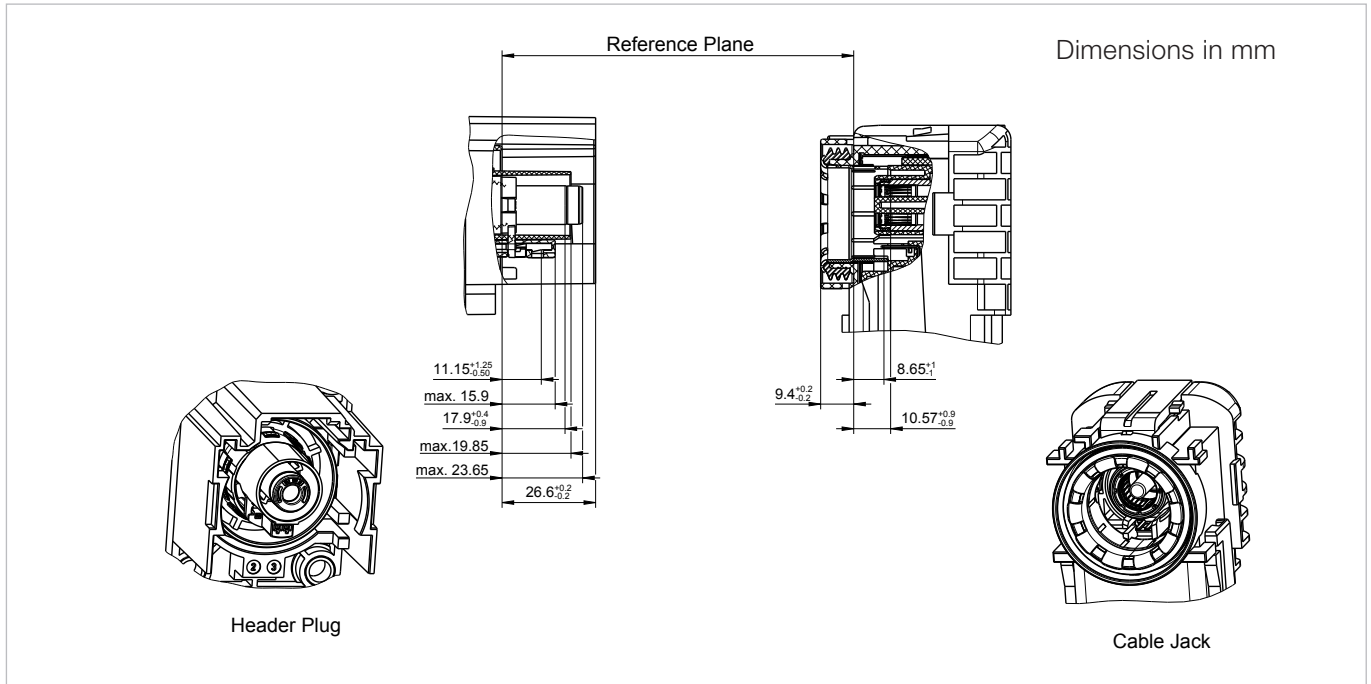

Derating Graph HVR®420 acc. to DIN EN 60512-5-2

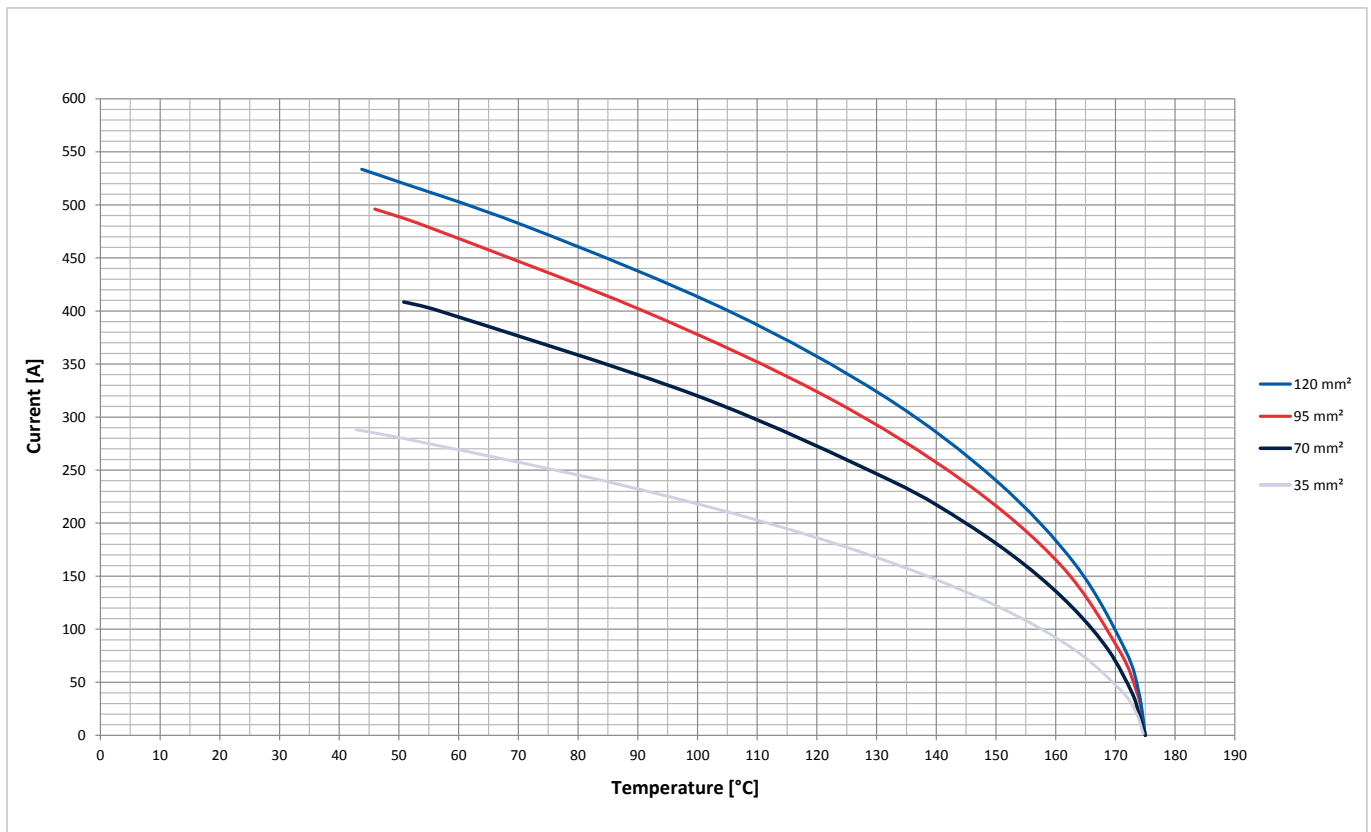

Technical Data HVR[®]420 (Code HA)

Applicable Standards

Interface according to	RN_113-01
------------------------	-----------

Electrical Data

Insulation resistance	≥ 200 MΩ at 1000 V DC
Voltage class	B 60 V DC <U ≤ 1500 V DC 30 V AC <U ≤ 1000 V AC
Center contact resistance	≤ 0.22 mΩ
Outer contact resistance	≤ 2.00 mΩ
Current capacity for 120 mm ²	450 A at 85 °C (Cu-cable)
Test voltage	2500 V DC
Working voltage	1000 V DC
High-Voltage Interlock (HVIL)	yes

Mechanical Data

Mating cycles	≥ 50
Engagement force	≤ 100 N
Disengagement force	≤ 100 N
Coding efficiency	≥ 300 N
Cable cross sections	35 mm ² , 70 mm ² , 95 mm ² , 120 mm ² on request
Cable connection angle	90°
Vibration class	according to LV215 PG17-II*
IP class (mated)	IP6K9K / IPX8
IP class (unmated)	IPXXB

* depending on cable fixation

Environmental Data

Temperature range	-40 °C to +125 °C
RoHS	compliant



Rosenberger connectors fulfill in principle the indicated data of the technical data. Individual values of connectors may deviate depending upon application, design, type of cable, assembly method and execution. Specific data sheets for particular products can be provided on request from your Rosenberger sales partner.

Products

HVR®420 Cable Jack

Rosenberger No.	Description	Max. Current at 85 °C	Cable Cross Section	Assembly Instruction	Product
HAK203-W10035B1-Y	Right angle jack	240 A	35 mm ²	MA_HV0076	
HAK203-W10070B1-Y	Right angle jack	350 A	70 mm ²	MA_HV0076	
HAK203-W10095B1-Y	Right angle jack	420 A	95 mm ²	MA_HV0076	
HAK203-W10120B1-Y	Right angle jack on request	450 A	120 mm ²	MA_HV0076	

HVR®420 Header Plug

Rosenberger No.	Description	Panel Piercing	Assembly Instruction	Product
HAS105-21-000B1-Y	Straight plug Busbar connection 180°	MB_569	MA_HV0061	
HAS103-21-000B1-Y	Straight plug Busbar connection 90°	MB_569	MA_HV0061	

-Y please fill in requested coding

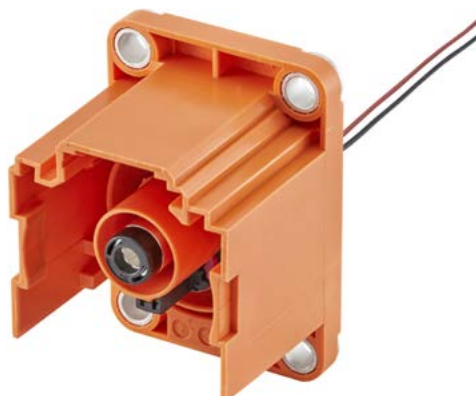

HPK

The Rosenberger HPK system can achieve 275 A at up to 1000 V. With their excellent vibration and current capacity performance the HPK connectors are well-suited to typical high voltage electric vehicle applications such as the connection between battery, inverter and PDU.

The range includes 1-, 2-, or 3-pole connectors which for maximum flexibility can be used with copper or aluminum cables in four different cable cross sections. Straight and angled cable couplers as well as corresponding headers are available, either with or without HVIL (high-voltage interlock).

Technical Properties

- Current capacity (50 mm²): 275 A at 85 °C
- Working voltage 1000 V DC
- Test voltage 3200 V DC
- Temperature range from -40 °C to +140 °C
- IP class mated acc. to IP6K9K / IPX8 / IPXXD
- IP class unmated acc. to IPXXB
- Vibration class acc. to LV215 PG17-II
- Mating cycles ≥ 50
- Cross sections 16 mm², 25 mm², 35 mm², 50 mm²



Features and Benefits

- Highest power with minimum installation space
- Versatile product range
- High temperature and vibration performance
- Design makes these series easier to assemble, creating faster processes and higher quality
- With or without HVIL (high-voltage interlock)

Applications

- Battery connection
- Inverter
- E-machine – PDU



Cables

Copper

- FHLR2GCB2G 16 mm² / 0.21
- FHLR2GCB2G 25 mm² / 0.21
- FHLR2GCB2G 35 mm² / 0.21
- FHLR2GCB2G 50 mm² / 0.21

Aluminum

- FHLALR2GCB2G 25 mm²
- FHLALR2GCB2G 35 mm²
- FHLALR2GCB2G 50 mm²



Derating Graph HPK acc. to DIN EN 60512-5-2

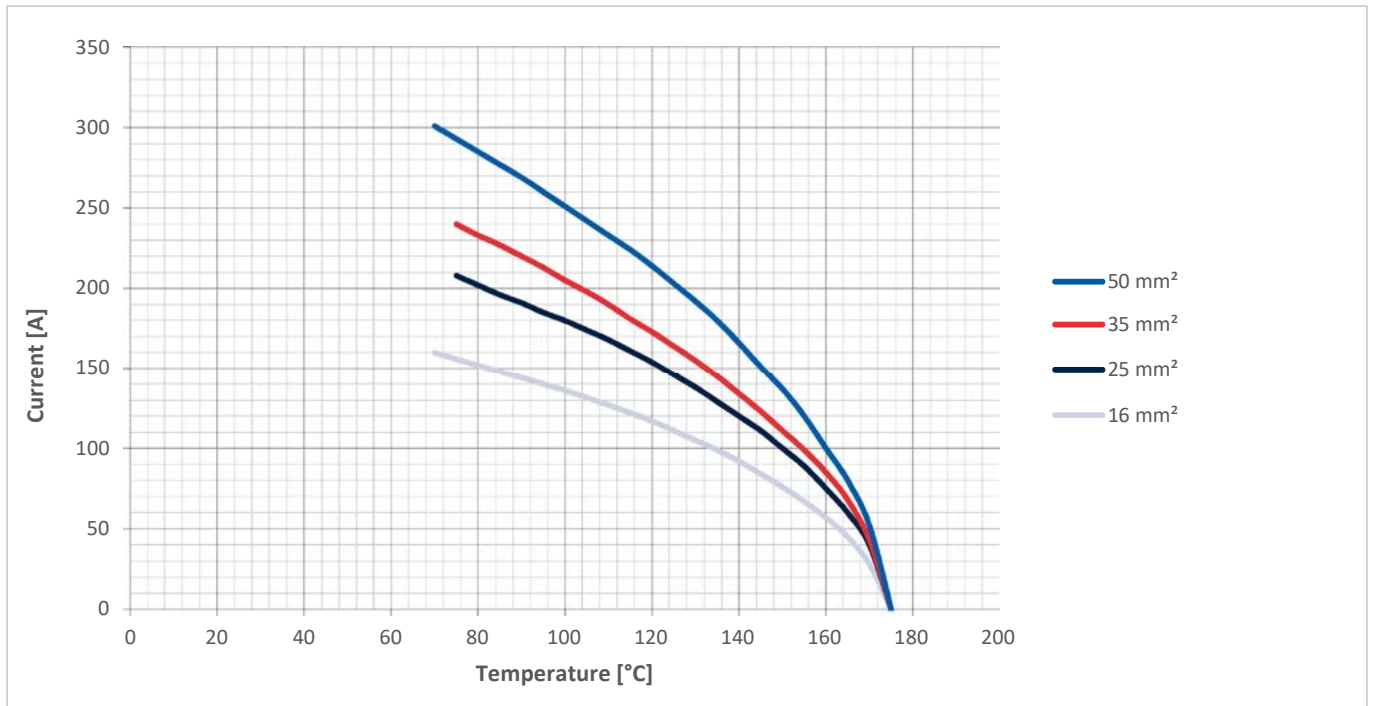

HPK Straight Copper Cables

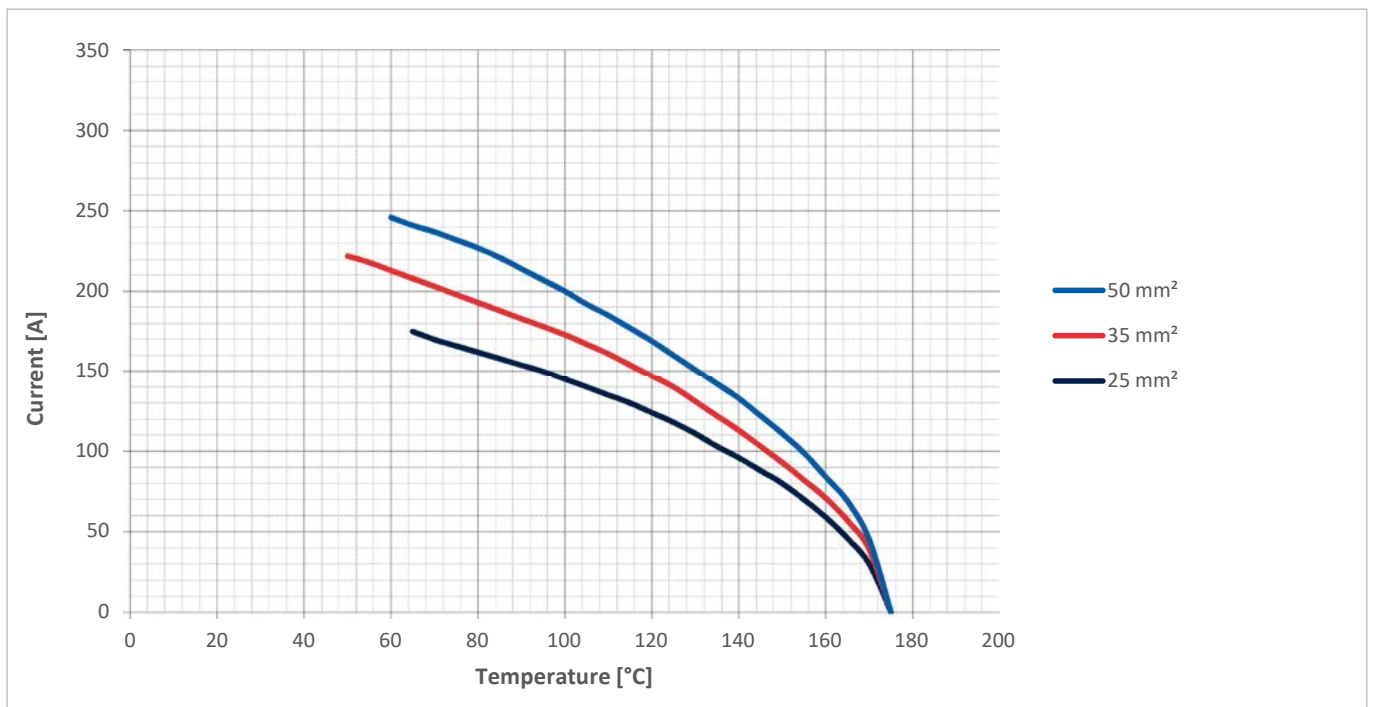

HPK Straight Aluminum Cables

Interface Dimensions HPK (Code H4)

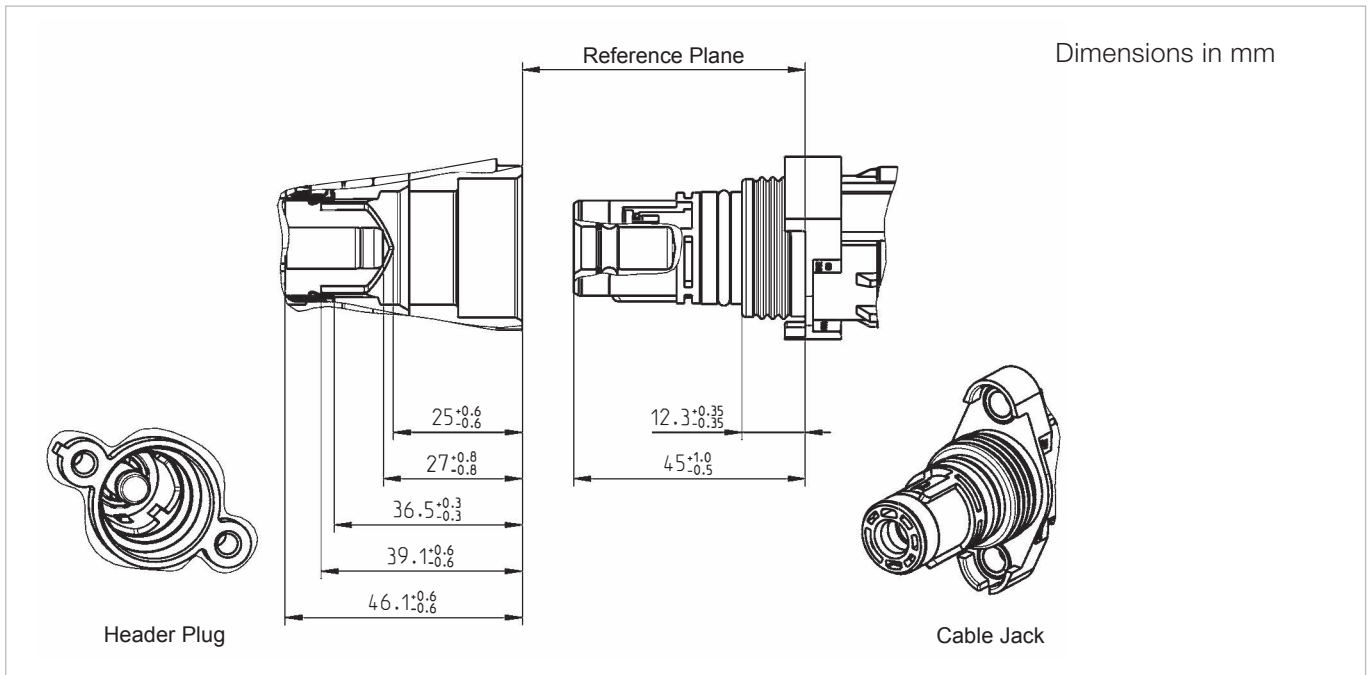

Coding HPK

Coding Housing		Coding Jack	Color/RAL-No. (Similar)		Jack
Z		A	Red/ 3001		
Z		B	Black/ 9005		
Z		C	Waterblue/ 5021		

Coding Housing		Coding Jack	Color/RAL-No. (Similar)		Jack
B		B	Black/ 9005		
		A	Red/ 3001		
C		B	Black/ 9005		
		C	Waterblue/ 5021		

Colors of the plastic housings are in accordance with the listed RAL colors, minor color differences during manufacturing are possible.

Technical Data HPK (Code H4)

Applicable Standards

Interface according to	Rosenberger RN_084-01 Rosenberger RN_087-01 Rosenberger RN_087-04
------------------------	---

Electrical Data

Insulation resistance	≥ 200 MΩ
Voltage class	B 60 V DC < U ≤ 1500 V DC 30 V AC < U ≤ 1000 V AC
Center contact resistance	≤ 0.26 mΩ
Outer contact resistance	≤ 10 mΩ
Current capacity for 50 mm ²	275 A at 85 °C
Test voltage	3200 V DC
Working voltage	1000 V DC
High-Voltage Interlock (HVIL)	available

Mechanical Data

Mating cycles	≥ 50
Engagement force	1-pole: < 75 N 2-pole: < 100 N
Coding efficiency	≥ 300 N
Cable cross sections copper	16 mm ² , 25 mm ² , 35 mm ² , 50 mm ²
Cable cross sections aluminum	25 mm ² , 35mm ² , 50 mm ²
Cable connection angle	90°, 180°
Vibration class	LV215 PG17-II
IP class (mated)	IP6K9K / IPX8 / IPXXD
IP class (unmated)	IPXXB
Touch proof	acc. to DIN EN 60529



Environmental Data

Temperature range	-40 °C to +140 °C
RoHS	compliant

Rosenberger connectors fulfill in principle the indicated data of the technical data. Individual values of connectors may deviate depending upon application, design, type of cable, assembly method and execution. Specific data sheets for particular products can be provided on request from your Rosenberger sales partner.

Products

HPK Cable Jack with HVIL

Rosenberger No.	Description	Max. Current at 85 °C	Cable Cross Section	Assembly Instruction	Product
H4K134-W10016B1-YY	Straight jack 1-pole Screw locking feature With HVIL	150 A (Cu)	16 mm ²	MA_HV0104	
H4K134-W10025B1-YY		205 A (Cu) 170 A (Al)	25 mm ²		
H4K134-W10035B1-YY		220 A (Cu) 170 A (Al)	35 mm ²		
H4K134-W10050B1-YY		275 A (Cu) 225 A (Al)	50 mm ²		
H4K136-W10016B1-YY	Straight jack 1-pole With HVIL	150 A (Cu)	16 mm ²	MA_HV0104	
H4K136-W10025B1-YY		205 A (Cu) 170 A (Al)	25 mm ²		
H4K136-W10035B1-YY		220 A (Cu) 170 A (Al)	35 mm ²		
H4K136-W10050B1-YY		275 A (Cu) 225 A (Al)	50 mm ²		
H4K215-W1U035B1-YY	Right angle jack 1-pole	220 A (Cu) 170 A (Al)	35 mm ²	On request	
H4K215-W1U050B1-YY		270 A (Cu) 210 A (Al)	50 mm ²		

HPK Header Plug with HVIL

Rosenberger No.	Description	Assembly Instruction	Product
H4S115-91-H00B-Y	Header 1-pole With HVIL	MA_HV0039	

HVIL: High-Voltage Interlock Contact

-YY: please fill-in requested coding



-YYY: please fill-in requested coding

Protection Cap

Rosenberger No.	Description	Product
170-101-00000	Protection cap for jack With and without HVIL	

Products

HPK Cable Jack with HVIL

Rosenberger No.	Description	Max. Current at 85 °C	Cable Cross Section	Assembly Instruction	Product
H4K134-W20016B1-YYY	Straight jack 2-pole Screw locking feature With HVIL	150 A (Cu)	16 mm ²	MA_HV0105	
H4K134-W20025B1-YYY		205 A (Cu) 170 A (Al)	25 mm ²		
H4K134-W20035B1-YYY		220 A (Cu) 170 A (Al)	35 mm ²		
H4K134-W20050B1-YYY		275 A (Cu) 225 A (Al)	50 mm ²		
H4K136-W20016B1-YYY	Straight jack 2-pole With HVIL	150 A (Cu)	16 mm ²	MA_HV0105	
H4K136-W20025B1-YYY		205 A (Cu) 170 A (Al)	25 mm ²		
H4K136-W20035B1-YYY		220 A (Cu) 170 A (Al)	35 mm ²		
H4K136-W20050B1-YYY		275 A (Cu) 225 A (Al)	50 mm ²		
H4K210-W2U035B1-YYY	Right angle jack 2-pole, cable down Screw locking feature With HVIL	220 A (Cu) 170 A (Al)	35 mm ²	MA_HV0051	
H4K210-W2U050B1-YYY		275 A (Cu) 225 A (Al)	50 mm ²		

HPK Header Plug with HVIL

Rosenberger No.	Description	Assembly Instruction	Product
H4S115-92-H00B-YY	Header 2-pole With HVIL	MA_HV0048	



HVIL: High-Voltage Interlock Contact

-YY: please fill-in requested coding

-YYY: please fill-in requested coding

Products

HPK Cable Jack without HVIL

Rosenberger No.	Description	Max. Current at 85 °C	Cable Cross Section	Assembly Instruction	Product
H4K135-W10016B1-YY	Straight jack 1-pole Screw locking feature Without HVIL	150 A (Cu)	16 mm ²	MA_HV0104	
H4K135-W10025B1-YY		205 A (Cu) 170 A (Al)	25 mm ²		
H4K135-W10035B1-YY		220 A (Cu) 170 A (Al)	35 mm ²		
H4K135-W10050B1-YY		275 A (Cu) 225 A (Al)	50 mm ²		
H4K137-W10016B1-YY	Straight jack 1-pole Without HVIL	150 A (Cu)	16 mm ²	MA_HV0104	
H4K137-W10025B1-YY		205 A (Cu) 170 A (Al)	25 mm ²		
H4K137-W10035B1-YY		220 A (Cu) 170 A (Al)	35 mm ²		
H4K137-W10050B1-YY		275 A (Cu) 225 A (Al)	50 mm ²		

HPK Header Plug without HVIL

Rosenberger No.	Description	Assembly Instruction	Product
H4S115-91-000B-Y	Header 1-pole Without HVIL	MA_HV0039	

HVIL: High-Voltage Interlock Contact

-YY: please fill-in requested coding

-YYY: please fill-in requested coding

Protection Cap

Rosenberger No.	Description	Product
170-101-00000	Protection cap for jack With and without HVIL	

Products

HPK Cable Jack without HVIL

Rosenberger No.	Description	Max. Current at 85 °C	Cable Cross Section	Assembly Instruction	Product
H4K135-W20016B1-YYY	Straight jack 2-pole Screw locking feature Without HVIL	150 A (Cu)	16 mm ²	MA_HV0105	
H4K135-W20025B1-YYY		205 A (Cu) 170 A (Al)	25 mm ²		
H4K135-W20035B1-YYY		220 A (Cu) 170 A (Al)	35 mm ²		
H4K135-W20050B1-YYY		275 A (Cu) 225 A (Al)	50 mm ²		
H4K137-W20016B1-YYY	Straight jack 2-pole Without HVIL	150 A (Cu)	16 mm ²	MA_HV0105	
H4K137-W20025B1-YYY		205 A (Cu) 170 A (Al)	25 mm ²		
H4K137-W20035B1-YYY		220 A (Cu) 170 A (Al)	35 mm ²		
H4K137-W20050B1-YYY		275 A (Cu) 225 A (Al)	50 mm ²		
H4K208-W2U025B1-YYY	Right angle jack 2-pole, cable down Screw locking feature Without HVIL	175 A (Cu)	25 mm ²	MA_HV0051	
H4K208-W2U035B1-YYY		220 A (Cu) 170 A (Al)	35 mm ²		
H4K208-W2U050B1-YYY		270 A (Cu) 210 A (Al)	50 mm ²		
H4K209-W2U025B1-YYY	Right angle jack 2-pole, cable up Screw locking feature Without HVIL	175 A (Cu)	25 mm ²	MA_HV0051	
H4K209-W2U035B1-YYY		220 A (Cu) 170 A (Al)	35 mm ²		
H4K209-W2U050B1-YYY		270 A (Cu) 210 A (Al)	50 mm ²		

HPK Header Plug without HVIL

Rosenberger No.	Description	Assembly Instruction	Product
H4S115-92-000B-YY	Header 2-pole Without HVIL	MA_HV0048	

HVIL: High-Voltage Interlock Contact

-YY: please fill-in requested coding

-YYY: please fill-in requested coding

HPK Measurement

Rosenberger's High-Voltage Test & Measurement Solutions deliver deep insights into the EMC behaviors of high-voltage Automotive Traction Networks. Using our powerful HPK Measurement Coupler Kit, dedicated Calibration Software and Calibration Kits, EMC experts can perform RF voltage and current reliability calculations with absolute precision.

HPK Measurement Coupler Kit

The newly developed HPK Measurement Coupler Kit from Rosenberger enables a minimally invasive testing method for measuring the reliability of RF voltages and currents. In conjunction with a dedicated calibration process, patented algorithms accurately calculate the RF currents and voltages in the calibration reference plane.

Furthermore, due to the minimal invasion techniques deployed by the coupler there is no risk of impairment to harness performance when under test. The watertight and robust design also means testing can be carried out under any environmental conditions.

HPK Calibration Kit

Although the HPK measurement coupler includes calibration data, an optional HPK calibration kit is also available. Combined with the RCTD software it enables customers to manage their own calibration requirements themselves. A set of all necessary calibration standards is provided and a description for the acquisition of calibration files is included in the RCTD user manual.

Rosenberger recommends 12-monthly calibration intervals and offers a recalibration service to HPK coupler customers if required.

RCTD Software

Rosenberger Calibrated Time Domain Software (RCTD) was developed to enhance EMC-related, automotive high-voltage measurement capabilities. Within the RCTD Software, the time domain data captured by an oscilloscope using the high-voltage coupler is post-processed to calculate high frequency currents and voltages at the given calibration plane within the high-voltage power train. Therefore, calibration data is created and taken into account before measurement occurs.



Delivered on a USB-stick in a sturdy wooden box, the RCTD Software includes the functions to create calibration data and post process the measurement data on a PC or directly on LeCroy HDO oscilloscopes for real-time evaluation. The software can be also used for any other directional coupler.



For further information please see our video
"Rosenberger Calibrated Time Domain (RCTD)
Measurement":

https://www.youtube.com/watch?v=NaoL-_tF3zM

HPK Measurement

Rosenberger No.	Description	Product
H4CK10A-110	Measurement Coupler Kit Delivered in a stable wooden box with SMA measurement cables, SMA terminations and calibration data on a USB Stick.	
H4CK10B-110	HPK Calibration Kit (optional) Delivered in a stable wooden box and includes all the components necessary for calibrating the HPK Measurement Coupler in combination with the RCTD software calibration routine.	
RCTD-Software	Rosenberger Calibrated Time Domain Software Delivered on a USB-Stick in a stable wooden box. The Software has a hardware-bound license where the USB-Stick is used as dongle. The Software includes the functions for PC, LeCroy HDO oscilloscopes and the calibration routines.	

Benefits

- Transients and non-linear effects can be displayed in time domain or frequency domain
- Calibration allows accurate definition of a reference plane even for high-frequency, position-dependent voltage and current distributions
- Calibration performed in advance with a vector network analyzer using specifically designed high-voltage standards for the highest accuracy
- Coupler concept is compatible to special type of Rosenberger HPK connector without coding
- No impairment of harness performance under test conditions
- Waterproofness enables tests under any environmental conditions
- Output of coupler is galvanically isolated to high-voltage conductors – every device is high-voltage tested
- Independent determination of voltage and current
- Determination of source and load impedance during operation possible.



DCS

With its high capacity, compact design, the Rosenberger DCS is perfect for space-confined high voltage applications where direct connection is a prerequisite. With a cable cross-section of just 70 mm² the current carrying capacity is 340 A at 85 °C, making it ideal for battery charging or enabling direct connection between the battery and motor components used in electric vehicles.

The combination of contact and retaining tabs ensures a simple plug-in action is all that's required to achieve a totally secure connection. Furthermore, this robust and versatile connection system also offers detachable and non-detachable variants.

Technical Properties

- Current capacity (70 mm²): 340 A at 85 °C
- Working voltage 1000 V DC
- Test voltage 4300 V DC
- Temperature range from -40 °C to +130 °C
- IP class mated acc. to IP6K9K / IPXXD
- Vibration class acc. to LV215 PG17-II
- Cross sections 35 mm², 50 mm², 70 mm²
- Disconnectable version under development



Features and Benefits

- Allows direct connection between cable and PDU (Power Distribution Units)
- Minimal installation space
- Removable or unremovable









Applications

- Battery connection
- E-machine
- Charger

Cables

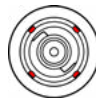
- FHLR2GCB2G 35 mm² / 0.21 mm
- FHLR2GCB2G 50 mm² / 0.20 mm
- FHLR2GCB2G 70 mm² / 0.20 mm

Coding DCS

Coding	Color/RAL-No. (Similar)		Jack Removable	Jack Unremovable	Plug
A	Red/3001				
B	Black/9005				

Colors of the plastic housings are in accordance with the listed RAL colors, minor color differences during manufacturing are possible.

Interface Dimensions DCS (Code H9)

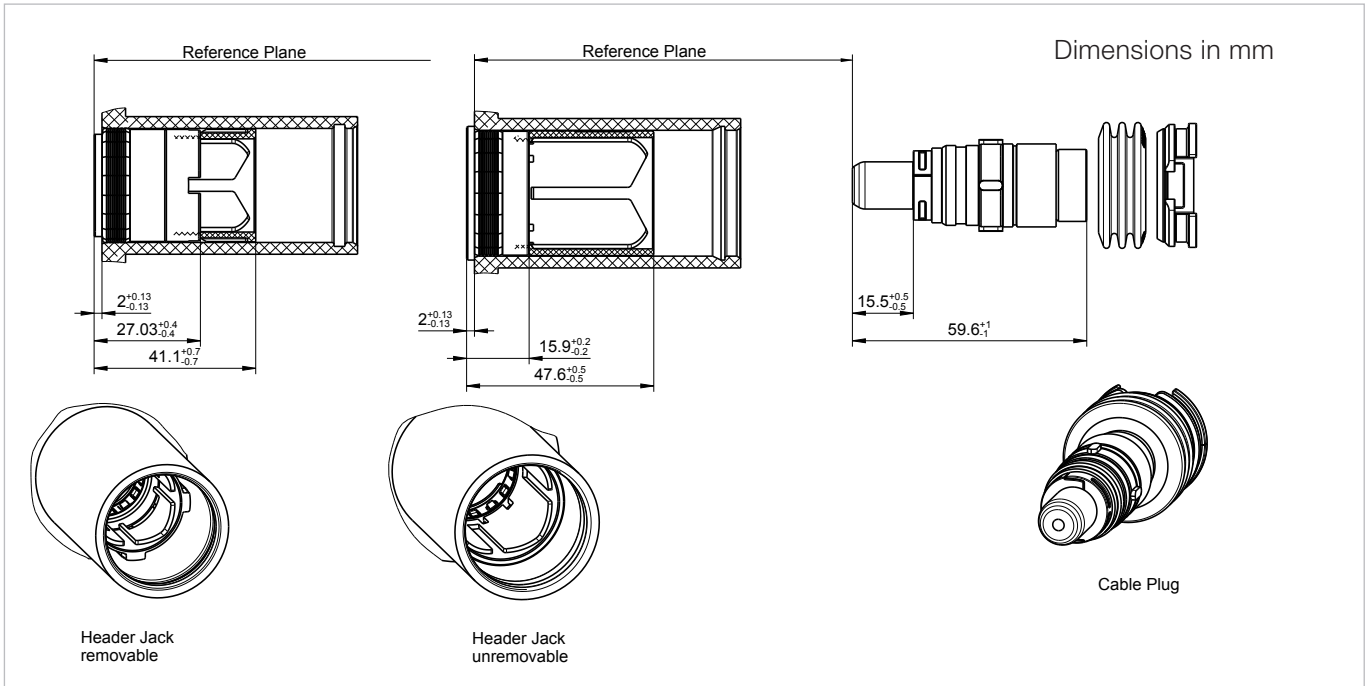

Derating Graph DCS acc. to DIN EN 60512-5-2

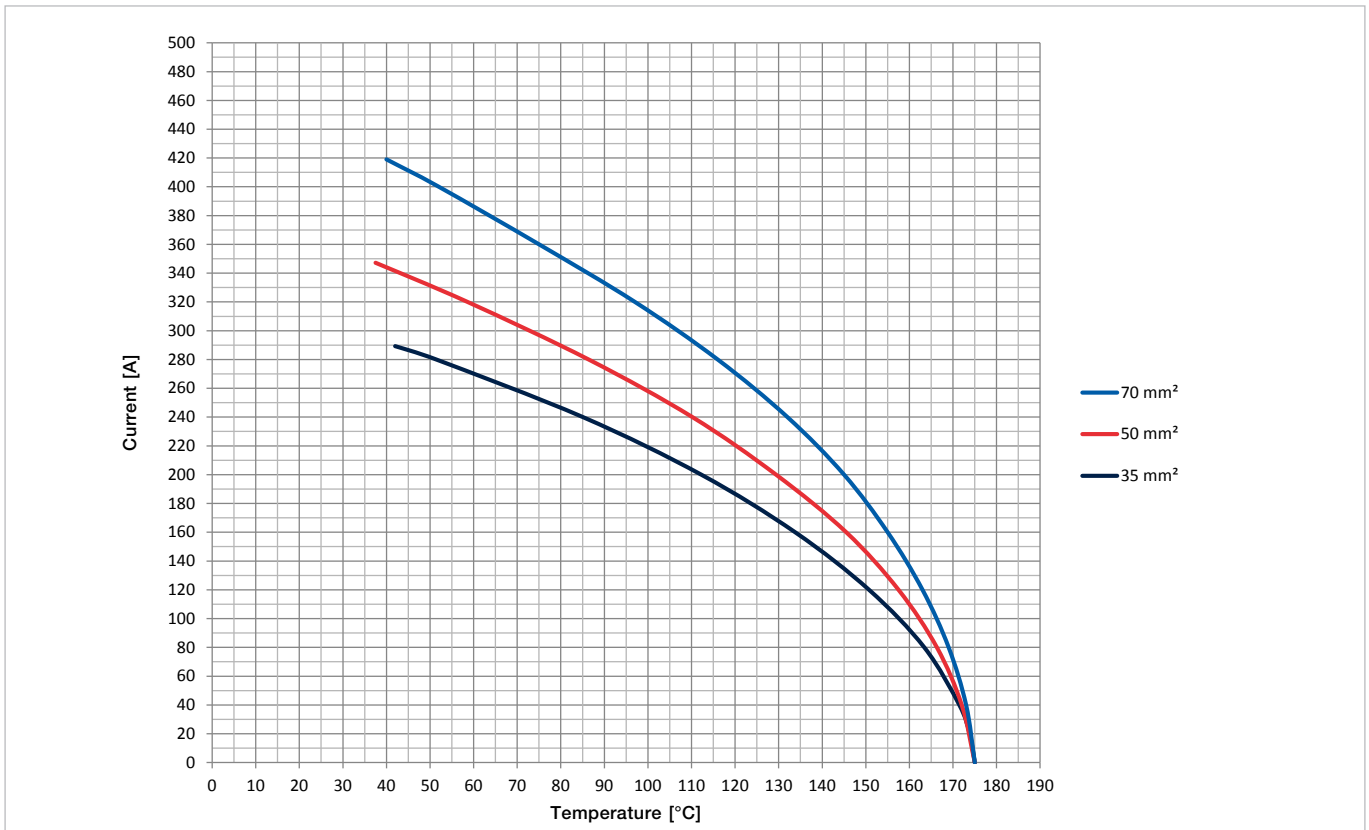

Technical Data DCS (Code H9)

Applicable Standards

Interface according to	RN_103-01
------------------------	-----------

Electrical Data

Insulation resistance	$\geq 200 \text{ M}\Omega$ at 1000 V DC
Voltage class	B 60 V DC < U \leq 1500 V DC 30 V AC < U \leq 1000 V AC
Center contact resistance	$\leq 0.24 \text{ m}\Omega$
Outer contact resistance	< 9.00 m Ω
Current capacity for 70 mm ²	340 A at 85 °C
Test voltage	4300 V DC
Working voltage	1000 V

Mechanical Data

Engagement force	< 100 N
Coding efficiency	> 300 N
Cable cross sections	35 mm ² , 50 mm ² , 70 mm ²
Cable connection angle	180°
Vibration class	LV215 PG17-II
IP class (mated)	IPX6K9K / IPXXD



Environmental Data

Temperature range	-40 °C to +130 °C
RoHS	compliant



Rosenberger connectors fulfill in principle the indicated data of the technical data. Individual values of connectors may deviate depending upon application, design, type of cable, assembly method and execution. Specific data sheets for particular products can be provided on request from your Rosenberger sales partner.

Products



DCS Cable Plug, removable

Rosenberger No.	Description	Max. Current at 85 °C	Cable Cross Section	Assembly Instruction	Product
H9S109-11F035B1-Y	Straight plug, removable	220 A (Cu) 170 A (Al)	35 mm ²	MA_HV0050 MA_HV0085 MA_HV0086 MA_HV0089	
H9S105-W1F050B1-Y	Straight plug, removable	275 (Cu) 210 (Al)	50 mm ²	MA_HV0050 MA_HV0085 MA_HV0086 MA_HV0089	

DCS Cable Plug, unremovable

Rosenberger No.	Description	Max. Current at 85 °C	Cable Cross Section	Assembly Instruction	Product
H9S105-W1F035B1-Y	Straight plug, unremovable	225 A (Cu) 175 (Al)	35 mm ²	MA_HV0037 MA_HV0085 MA_HV0089	
H9S105-W1F070B1-Y	Straight plug, unremovable	340 A	70 mm ²	MA_HV0037 MA_HV0085 MA_HV0089	

DCS Header Jack, removable

Rosenberger No.	Description	Assembly Instruction	Product
H9K106-51-050/90B	Press in sleeve, removable Applicable for H9S109-11F035B1-Y, H9S105-W1F050B1-Y	MA_HV0083 MA_HV0086 MA_HV0089	
H9K105-51-050/80-Y	Coding sleeve, removable Applicable for H9K106-51-050/90B	MA_HV0083	

-Y: please fill-in requested coding

DCS Header Jack, unremovable

Rosenberger No.	Description	Assembly Instruction	Product
H9K106-51-070B-Y	Press in sleeve, unremovable Applicable for H9S105-W1F070B1-Y, H9S105-W1F035B1-Y	MA_HV0083 MA_HV0089	

-Y: please fill-in requested coding

HV Fuse

Technical Data HV Fuse (Code H1)

Applicable Standards

Interface according to	Rosenberger RN_091-01
------------------------	-----------------------

Electrical Data

Insulation resistance	$\geq 1 \times 10^4 \text{ M}\Omega$
Voltage class	B 60 V DC < U ≤ 1500 V DC 30 V AC < U ≤ 1000 V AC
Center contact resistance	≤ 1.44 mΩ
Outer contact resistance	≤ 10 mΩ
Test voltage	2700 V DC
Working voltage	max. 850 V DC

Mechanical Data

Mating cycles	≥ 25
Engagement force	≤ 100 N
Retention force connector	≤ 100 N
Disengagement force	≤ 100 N
Coding efficiency	according to LV215 PG9
Vibration class	according to LV215 PG17-II
IP class (mated)	IPX4

Environmental Data

Temperature range	-40 °C to +125 °C
RoHS	compliant

Rosenberger connectors fulfill in principle the indicated data of the technical data. Individual values of connectors may deviate depending upon application, design, type of cable, assembly method and execution. Specific data sheets for particular products can be provided on request from your Rosenberger sales partner.

HV Fuses

Rosenberger HV fuses ensure the safety of high voltage PDUs used in electric vehicles. Watertight and vibration-proof, they feature a HVIL (High-Voltage Interlock) and are characterized by their lightweight plastic housing. Fuses and the corresponding insert can easily be replaced without opening the component housing.

Technical Properties

- Range 10 - 40 A
- Vibration class II acc. to LV215 PG17
- IP Class mated acc. to IPX4

Features and Benefits

- Lightweight
- Watertight
- Changeable

Applications

- High-voltage safety for PDUs (Power Distribution Units)

Products

HV Fuse

Rosenberger No.	Description	Product
H1S103-92SLF0B1-Y	Changeable fuses 10 - 40 A on request	

HV Fuse Header

Rosenberger No.	Description	Panel Piercing	Assembly Instruction	Product
H1K103-92SLF0B1-Y	Fuse header	MB_467	MA_HV0021	

HV Components

Complementing its standard connector portfolio, Rosenberger develops and manufactures customer-specific high-voltage components for electric and hybrid vehicles. These enable the lowest possible transition resistances, ensuring long-term low-loss performance and reliability in critical electrical systems such as those for battery charging, cell management, heating, and air conditioning.

From concept to final delivery, Rosenberger high voltage custom components are the perfect fit every time. Using its component toolkit, including PDUs, Y-splitters, Busbars and Cell Modules, Rosenberger can develop and manufacture a wide array of tailor-made solutions. These are designed and configured precisely to the relevant vehicle architecture, allowing ideal combinations of the various fuses, relays and other passive and active components required.

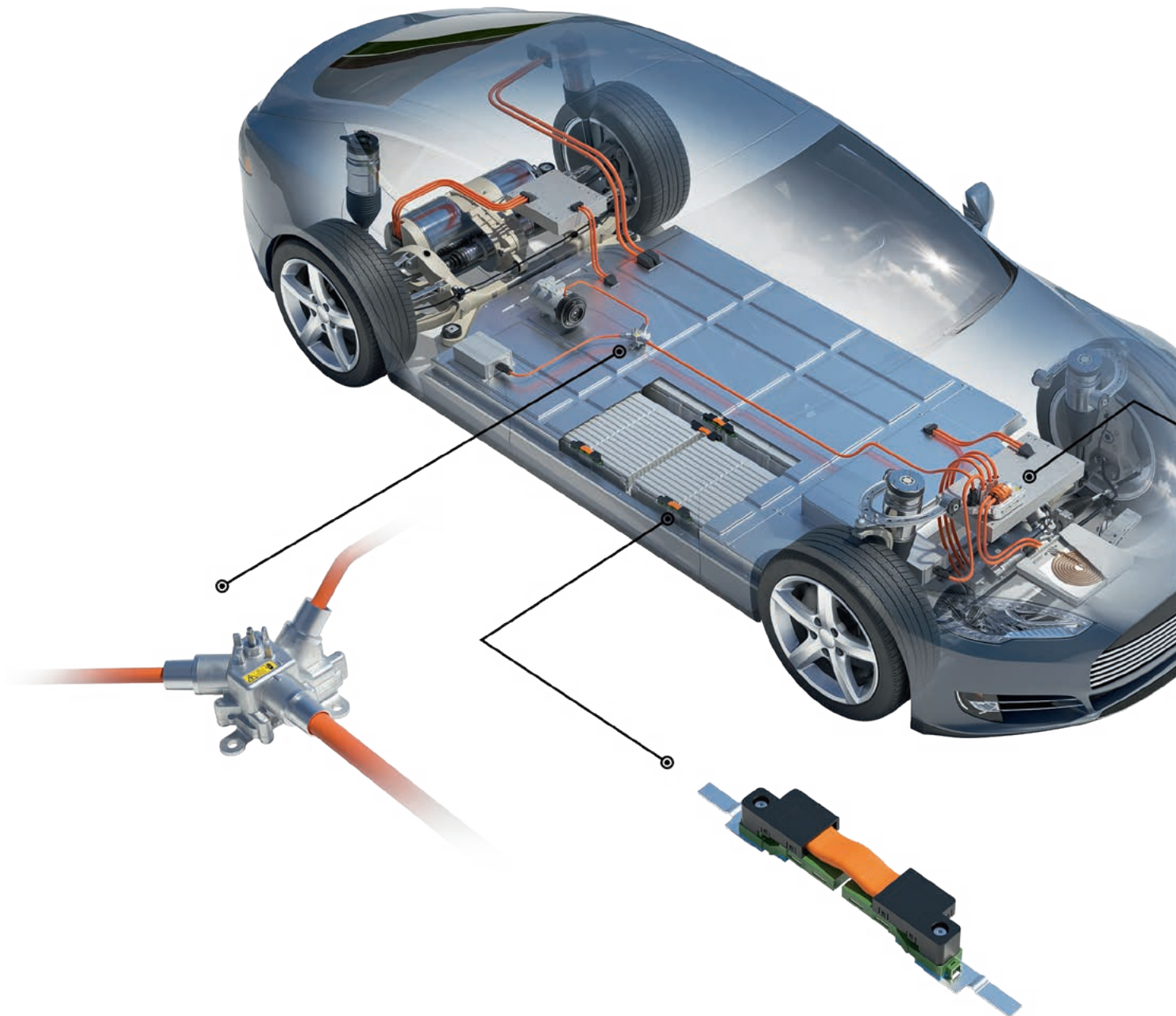

Power Distribution Units (PDU)

Power distribution units (PDU) for vehicles have multiple power input and outputs and use all kinds of connectors, fuses, and relays. In these cases, the PDU generally forms the central link between the vehicle power electronics and batteries, electric motors, and other ancillary units.

Y-Splitters

Y-splitters are used to distribute the power from one cable harness to two or more units, e.g., between a DC/DC converter and an electric air-conditioning unit. Rosenberger can design Y-splitters for applications with and without shielding for cable cross sections from 4 mm² to 95 mm² in collaboration with the customer.

Cell Module Connectors

The Rosenberger HV portfolio also includes cell module connectors. These connectors are required to link battery modules within a battery pack. For typical battery applications, multiple custom-designed battery connection points are required. Based on the robust pressure contact system, Rosenberger offers cell module connectors without flexing parts in the contact area. Systems from 100 to 350 A are available. Different assembly directions, coding variants as well as cross sections can be implemented according to customer-specific requirements.

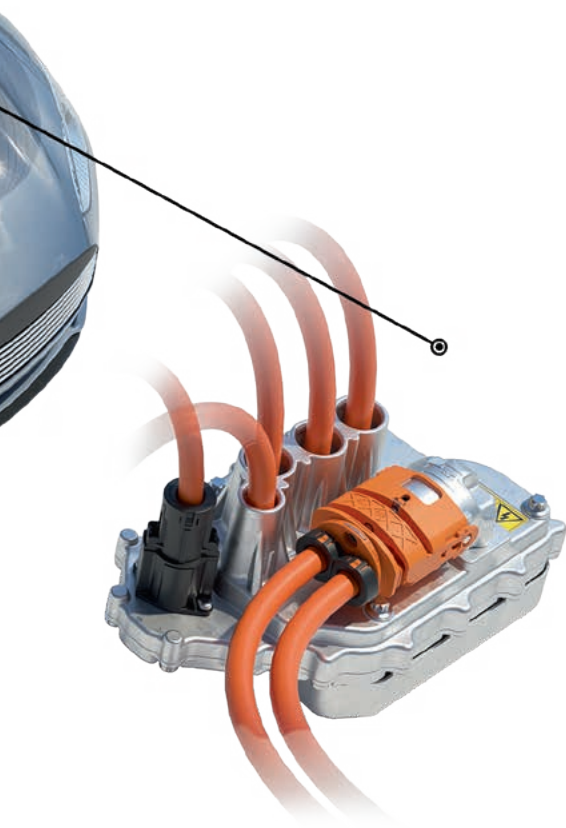

Products:

- Power distribution units and Y-splitters (aluminum housing)
- Busbars
- Contact systems
- Insulation material

Properties

- Insulation
- EMI shielded
- LV and HV interfaces
- AC and DC currents

Applications

- Cell connection
- Battery management

LVR[®]120

Compact and lightweight, low-voltage Rosenberger LVR[®]120 connectors are ideal for such applications as electrical superchargers. Achieving approximately 120 A at 85 °C with a cable cross section of just 16 mm² they are certified to Vibration Severity Level 4. Furthermore, the additional slide locking mechanism (CPA – Connector Position Assurance) prevents accidental unmating.

Technical Properties

- Current capacity (16 mm²): 120 A at 85 °C
- Working voltage 48 V DC
- Temperature range from -40 °C to +150 °C
- IP class mated acc. to IP6K9K / IPX8 / IPXXD
- Vibration class acc. to LV215 PG17-IV
- Mating cycles ≥ 50
- Cross sections 16 mm²

Features and Benefits

- Low weight
- Small dimensions

Applications







- Electrical supercharger

Cable

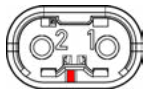
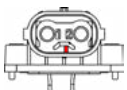
- FHL2G 16 mm² / 0.20 mm

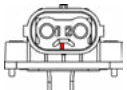

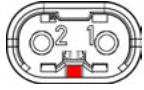
Coding LVR[®]120

Coding	Plug Color/RAL-No. (Similar)		Plug	Jack
A	Black/ 9005			
B	White/ 9010			
Z	Waterblue/ 5021			

Colors of the plastic housings are in accordance with the listed RAL colors, minor color differences during manufacturing are possible.

Interface Dimensions LVR[®]120 (Code H5)

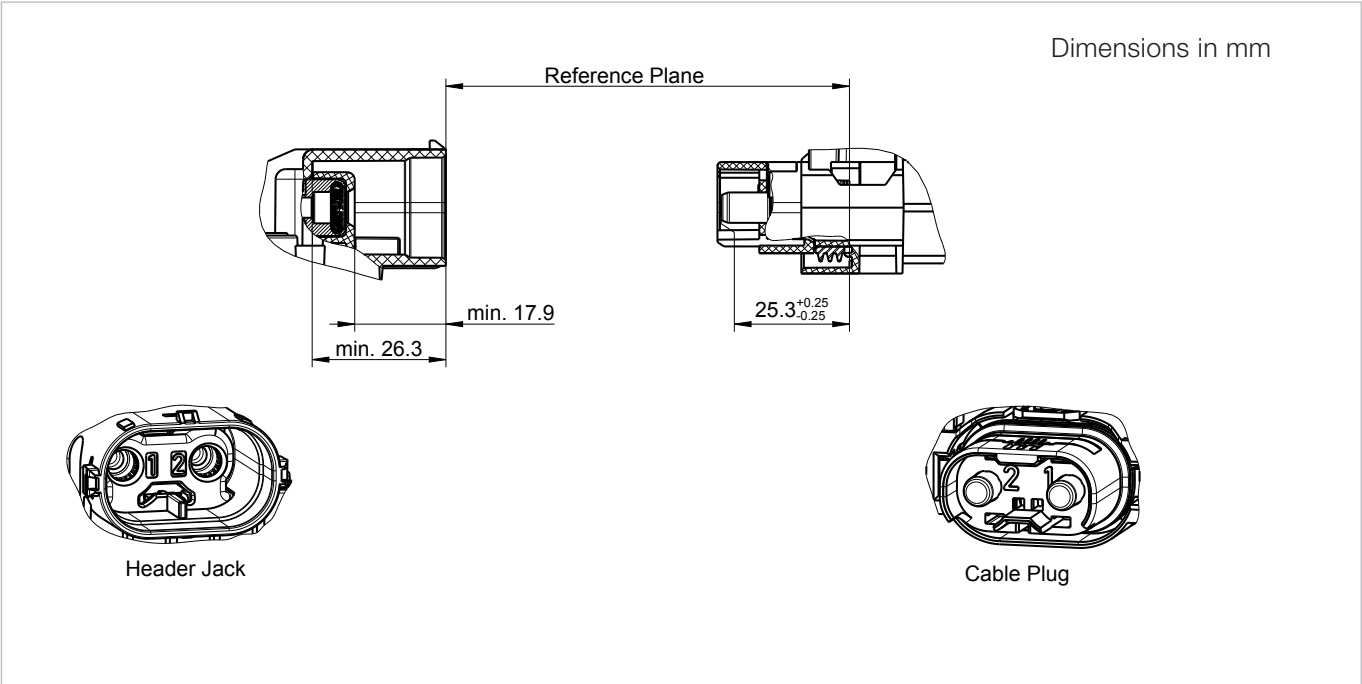

Derating Graph LVR[®]120 acc. to DIN EN 60512-5-2

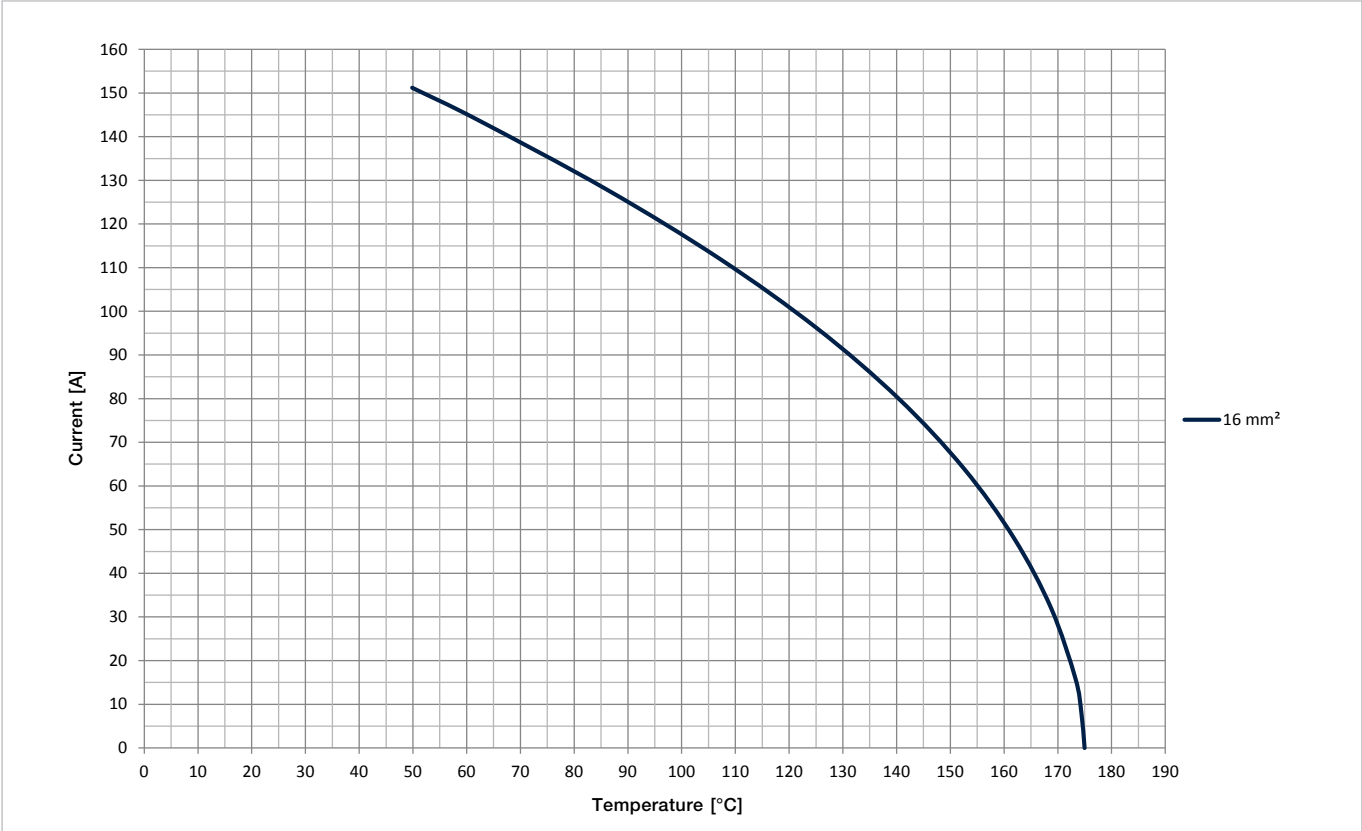

Technical Data LVR[®]120 (Code H5)

Applicable Standards

Interface according to	Rosenberger RN_110-03
------------------------	-----------------------

Electrical Data

Insulation resistance	> 200 MΩ
Center contact resistance	≤ 0.30 mΩ
Current capacity for 16 mm ²	120 A at 85 °C
Test voltage	500 V DC
Working voltage	48 V

Mechanical Data

Mating cycles	≥ 50
Engagement force	≤ 80 N
Coding efficiency	≥ 300 N
Cable cross sections	16 mm ²
Cable connection angle	180°
Vibration class	according to LV215 PG17-IV
IP class (mated)	IP6K9K / IPX8 / IPXXD

Environmental Data

Temperature range	-40 °C to +150 °C
RoHS	compliant

Rosenberger connectors fulfill in principle the indicated data of the technical data. Individual values of connectors may deviate depending upon application, design, type of cable, assembly method and execution. Specific data sheets for particular products can be provided on request from your Rosenberger sales partner.

Products

LVR®120 Cable Plug

Rosenberger No.	Description	Max. Current at 85 °C	Cable Cross Section	Assembly Instruction	Product
H5S102-920016X1-Y	Straight plug Waterproof Available on request	120 A	16 mm ²	On request	

LVR®120 Header Jack

Rosenberger No.	Description	Assembly Instruction	Product
H5K203-92-000X1-Y	Right angle jack Header Available on request	On request	

-Y please fill in requested coding

Rosenberger No.

170-099-00005	29	H4K208-W2U050B1-YYY	47
170-101-00000	44, 46	H4K209-W2U025B1-YYY	47
H1K103-92SLF0B1-Y	55	H4K209-W2U035B1-YYY	47
H1S103-92SLF0B1-Y	55	H4K209-W2U050B1-YYY	47
H2K101-W2A016B1-Y	29	H4K210-W2U035B1-Y	45
H2K101-W2A035B1-Y	29	H4K210-W2U050B1-YYY	45
H2S104-02-000B1-Y	29	H4K215-W1U035B1-YY	44
H2S207-02-000B1-Y	29	H4K215-W1U050B1-YY	44
H4CK10A-110	49	H4S115-91-000B-Y	46
H4CK10B-110	49	H4S115-91-H00B-Y	44
H4K134-W10016B1-YY	44	H4S115-92-000B-Y	47
H4K134-W10025B1-YY	44	H4S115-92-H00B-Y	45
H4K134-W10035B1-YY	44	H5K203-92-000X1-Y	61
H4K134-W10050B1-YY	44	H5S102-920016X1-Y	61
H4K134-W20016B1-YYY	45	H6K105-12A006B-Y	25
H4K134-W20025B1-YYY	45	H6K106-12A004B1-Y	25
H4K134-W20035B1-YYY	45	H6K106-12A006B1-Y	25
H4K134-W20050B1-YYY	45	H6K107-12A006B1-Y	25
H4K135-W10016B1-YY	46	H6K205-12A006B-Y	25
H4K135-W10025B1-YY	46	H6K206-12A004B1-Y	25
H4K135-W10035B1-YY	46	H6K206-12A006B1-Y	25
H4K135-W10050B1-YY	46	H6K207-12A006-B1-Y	25
H4K135-W20016B1-YYY	47	H6L106-5B-001B1-Y	25
H4K135-W20025B1-YYY	47	H6L106-5C-001B1-Y	25
H4K135-W20035B1-YYY	47	H9K105-51-050/80-Y	53
H4K135-W20050B1-YYY	47	H9K106-51-050/90B	53
H4K136-W10016B1-YY	44	H9K106-51-070B-Y	53
H4K136-W10025B1-YY	44	H9S105-W1F035B1-Y	53
H4K136-W10035B1-YY	44	H9S105-W1F050B1-Y	53
H4K136-W10050B1-YY	44	H9S105-W1F070B1-Y	53
H4K136-W20016B1-YYY	45	H9S109-11F035B1-Y	53
H4K136-W20025B1-YYY	45	HAK203-W10035B1-Y	39
H4K136-W20035B1-YYY	45	HAK203-W10070B1-Y	39
H4K136-W20050B1-YYY	45	HAK203-W10095B1-Y	39
H4K137-W10016B1-YY	46	HAK203-W10120B1-Y	39
H4K137-W10025B1-YY	46	HAS103-21-000B1-Y	39
H4K137-W10035B1-YY	46	HAS105-21-000B1-Y	39
H4K137-W10050B1-YY	46	HKK204-W20070B1-Y	35
H4K137-W20016B1-YYY	47	HKS109-22-000B1-Y	35
H4K137-W20025B1-YYY	47	HKS110-22-000B1-Y	35
H4K137-W20035B1-YYY	47	HKS112-22-000B1-Y	35
H4K137-W20050B1-YYY	47	HKS113-22-000B1-Y	35
H4K208-W2U025B1-YYY	47	RCTD-Software	49
H4K208-W2U035B1-YYY	47		







Website

For more information refer to our website:
www.rosenberger.com/hv

Rosenberger

Rosenberger Hochfrequenztechnik GmbH & Co. KG

Hauptstraße 1 | 83413 Fridolfing

P.O. Box 1260 | 84526 Tittmoning

Germany

Phone +49 8684 18-0

info@rosenberger.com

www.rosenberger.com

Certified by IATF 16949 · DIN EN 9100 · ISO 9001 · ISO 14001

Order No.

pA 237240 · Info251HVCatEN

2000/2019

Rosenberger® is a registered trademark of Rosenberger Hochfrequenztechnik GmbH & Co. KG.
All rights reserved.

© Rosenberger 2019

X-ON Electronics

Largest Supplier of Electrical and Electronic Components

Click to view similar products for [Calibration Equipment](#) category:

Click to view products by [Rosenberger](#) manufacturer:

Other Similar products are found below :

[700P27](#) [AX-C830](#) [AKT8R112100](#) [AKT4R1121001](#) [AKT4R1122001](#) [AR604/P](#) [FLUKE-700G08](#) [461750](#) [AX-C850](#) [RT-820](#) [FLUKE 709](#)
[FLUKE-805](#) [AKT4R111100](#) [AKT4R111200](#) [AKT7111100J](#) [AKT7212100J](#) [AKT8R111100](#) [REF2510R](#) [K39-LCRR](#) [412355A](#) [461831](#)
[461895](#) [461920](#) [480400](#) [480403](#) [PRC15](#) [PRC20](#) [PRC30](#) [700P02](#) [700P27EX](#) [700P29](#) [FLUKE-714B/EN](#) [FLUKE-789](#) [FLUKE BP7235](#)
[U086](#) [U087](#) [03K30R-MSOTS3](#) [18CK010-150](#) [19CK010-150](#) [P5514-70M](#) [P5515-140M](#) [12890](#) [TACH-10](#) [461950](#) [461825](#) [461830](#) [461891](#)
[350456](#) [CAL73](#) [DCS025](#)