

Cement Fixed Resistors

PRM Type

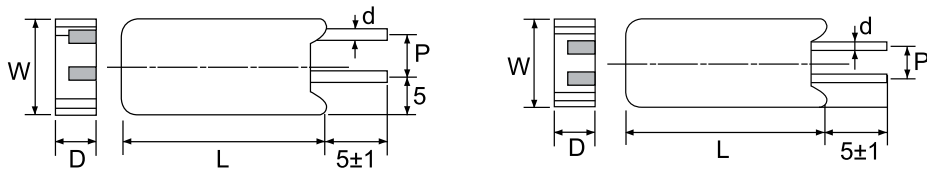

***PRM 7W, 10W : Lead not centered

*** PRM 2W, 3W, 5W,
PRMA 5W, 10W,
PRMB 7W } Lead centered

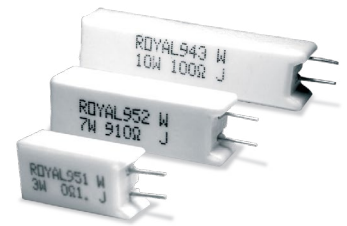

Part No.	Style	Power Rating at 70°C	Dimension (mm)					Resistance Range	
			W±1	D±1	L±1	d±0.05	P±1	Wire-wound	Power Film
PRM02W	PRM 2W	2W	11.5	7.5	20	0.75	5	0.1Ω ~ 27Ω	28Ω ~ 33KΩ
PRM03W	PRM 3W	3W	12.5	8.5	25	0.75	5	0.1Ω ~ 39Ω	40Ω ~ 56KΩ
PRM05W	PRM 5W	5W	13	9	25	0.75	5	0.1Ω ~ 47Ω	48Ω ~ 100KΩ
PRM07W	PRM 7W	7W	13	9	39	0.75	5	0.1Ω ~ 680Ω	681Ω ~ 200KΩ
PRM0AW	PRM 10W	10W	13	9	50	0.75	5	0.1Ω ~ 910Ω	911Ω ~ 200KΩ
PRMA5W	PRMA 5W	5W	13	9	25	0.75	7.5	0.1Ω ~ 47Ω	48Ω ~ 100KΩ
PRMAAW	PRMA 10W	10W	16	12	35	0.75	7.5	0.1Ω ~ 560Ω	561Ω ~ 100KΩ
PRMB7W	PRMB 7W	7W	13	9	39	0.75	5	0.1Ω ~ 680Ω	681Ω ~ 200KΩ

Remark: Max Worldrg Voltage: 500V
Max Overload Voltage: 1,000V

Heat Rise Chart (PRM)

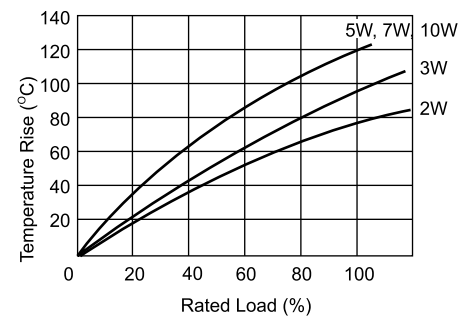

PRS Type

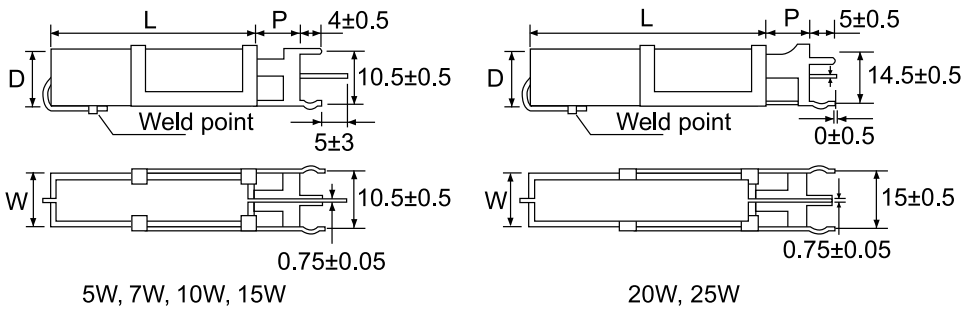

5W, 7W, 10W, 15W

20W, 25W

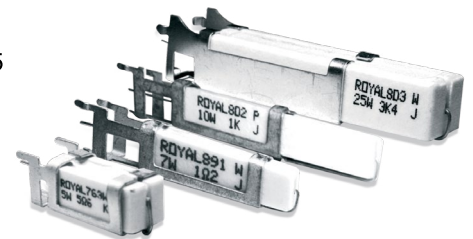

Part No.	Style	Power Rating at 70°C	Dimension (mm)					Resistance Range	
			W±1	D±1	L±1	d±0.05	P±1	Wire-wound	Power Film
PRS05W	PRS 5W	5W	10	9	22	0.75	5	0.1Ω ~ 47Ω	48Ω ~ 100KΩ
PRS07W	PRS 7W	7W	10	9	35	0.75	10	0.1Ω ~ 680Ω	681Ω ~ 200KΩ
PRS0AW	PRS 10W	10W	10	9	49	0.75	10	0.1Ω ~ 910Ω	911Ω ~ 200KΩ
PRS0FW	PRS 15W	15W	12.5	11.5	49	0.75	11	1Ω ~ 1KΩ	
PRS020	PRS 20W	20W	14.5	13.5	60	0.75	10	1Ω ~ 3.4KΩ	
PRS025	PRS 25W	25W	14.5	13.5	64	0.75	10	1Ω ~ 3.4KΩ	

Remark: Max Worldrg Voltage: 500V
Max Overload Voltage: 1,000V

Cement Fixed Resistors

PRS Recommended Hole

PRS 5W

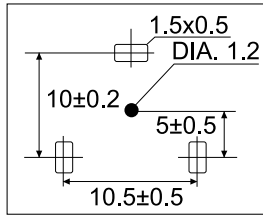

PRS 7W, 10W, 15W

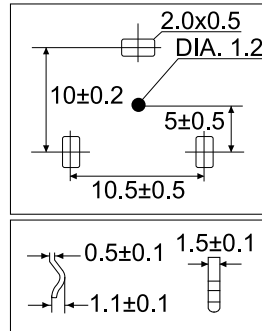

PRS 20W, 25W

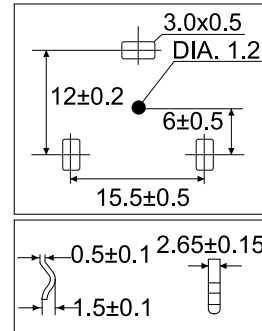

Heat Rise Chart (PRS)

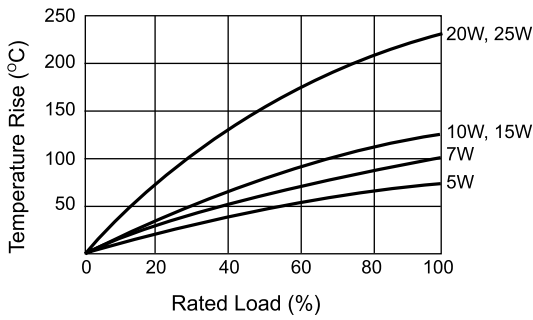

PRZA-1, PRZA-2, PRZA-3, PRZC, PRZD Type

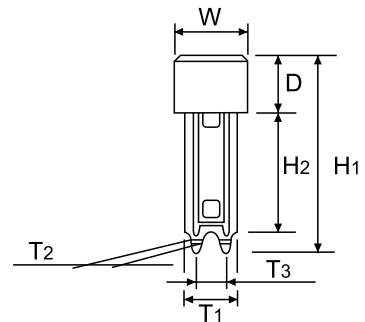
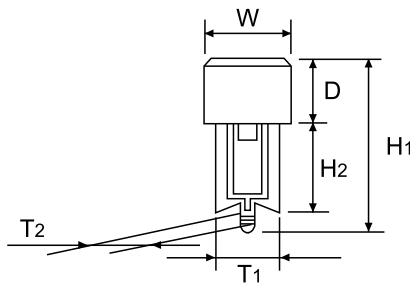
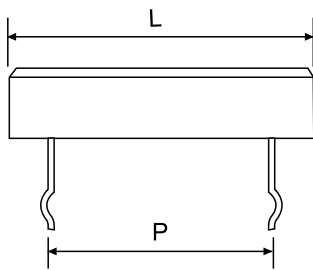

Recommended Hole

PRZA-1, PRZA-2, PRZA-3

PRZC, PRZD

Power Rating at 70°C	Dimension (mm)		
	PRZA-1, PRZA-2, PRZA-3	PRZC, PRZD	P
5W			9.5 / 15
7W			22
10W			32 / 35
15W			32
20W			45

X-ON Electronics

Largest Supplier of Electrical and Electronic Components

Click to view similar products for [Wirewound Resistors - SMD category:](#)

Click to view products by [Royal Ohm manufacturer:](#)

Other Similar products are found below :

[SMW5120RJT](#) [SMW518RJT](#) [SMW524RJT](#) [SMW52R2JT](#) [SMW530RJT](#) [WSM24R99FLFTR](#) [RWS5 R47 J B](#) [RWS5 R68 F B](#) [SMW516RJT](#)
[SMW52R7JT](#) [SMW57R5JT](#) [SMW5R33JT](#) [SMW5R39JT](#) [SMW551RJT](#) [SMW5R11JT](#) [RWS5 82R F B](#) [RWS5 1R F B](#) [RWS5 120R F B](#)
[RWS5 10R F B](#) [RWS5 100R J B](#) [SMW51R2JT](#) [SMW512RJT](#) [ACS-10S-15R-J](#) [PRZDAWJW101B00](#) [SMW3300RJT](#) [RW7S0FB180RJET](#)
[RW5S0FA470RJET](#) [RW7S0FB4K70JET](#) [RW7S0FB4K70FET](#) [RWS5 1R J B](#) [RWS5 33R J B](#) [QL0000J0100200](#) [QL0000J0220200](#)
[QL0000J0470100](#) [QL0000J047J100](#) [QL0050J0362000](#) [QL0050J0470000](#) [R100W-10R](#) [R100W-22R](#) [R100W-4R7](#) [R150W-470R](#)
[HEWRB0J0220600](#) [R200W-22R](#) [R50W-10R](#) [R50W-22R](#) [R50W-2R2](#) [R80W-47R](#) [SMW5R51JT](#) [SMW5R36JT](#) [SMW5R24JT](#)