

# Cement Fixed Resistors

## PRM Type

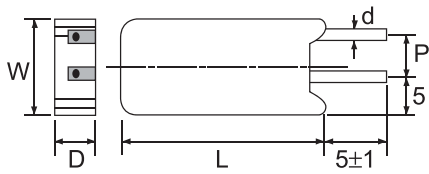

\*\*\*PRM 7W: Lead not centered

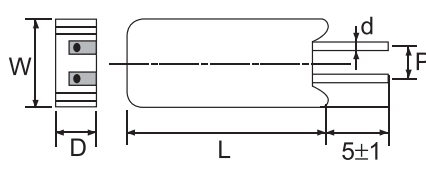

\*\*\* PRM 2W, 3W, 5W, 10W, PRMA 5W, 10W, PRMB 7W } Lead centered



Part No.	Style	Power Rating at 70°C	Dimension (mm)					Resistance Range	
			W±1	D±1	L±1	d±0.05	P±1	Wire-wound	Power Film
PRM02W	PRM 2W	2W	11.5	7.5	20	0.75	5	0.1Ω ~ 27Ω	28Ω ~ 33KΩ
PRM03W	PRM 3W	3W	12.5	8.5	25	0.75	5	0.1Ω ~ 39Ω	40Ω ~ 56KΩ
PRM05W	PRM 5W	5W	12.5	9	25	0.75	5	0.1Ω ~ 47Ω	48Ω ~ 100KΩ
PRM07W	PRM 7W	7W	12.5	9	38	0.75	5	0.1Ω ~ 680Ω	681Ω ~ 200KΩ
PRM0AW	PRM 10W	10W	12.5	9	50	0.75	5	0.1Ω ~ 910Ω	911Ω ~ 200KΩ
PRMA5W	PRMA 5W	5W	12.5	9	25	0.75	7.5	0.1Ω ~ 47Ω	48Ω ~ 100KΩ
PRMAAW	PRMA 10W	10W	16	12	35	0.75	7.5	0.1Ω ~ 560Ω	561Ω ~ 100KΩ
PRMB7W	PRMB 7W	7W	12.5	9	38	0.75	5	0.1Ω ~ 680Ω	681Ω ~ 200KΩ

Remark: Max Working Voltage: 500V  
Max Overload Voltage: 1,000V

Heat Rise Chart (PRW)

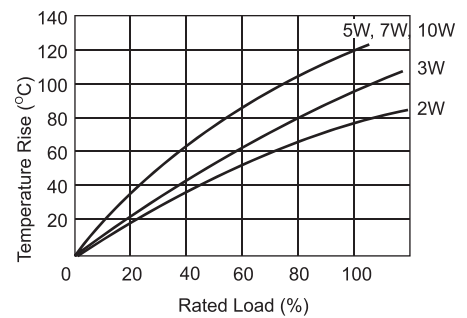

## PRS Type

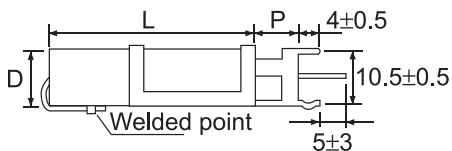

5W, 7W, 10W, 15W

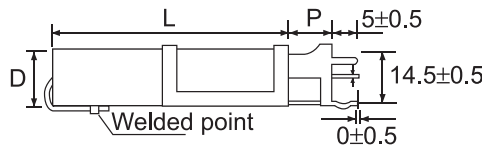

20W, 25W

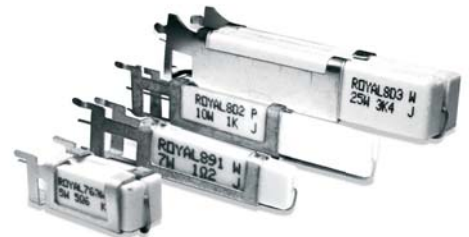

Part No.	Style	Power Rating at 70°C	Dimension (mm)					Resistance Range	
			W±1	D±1	L±1	d±0.05	P±1	Wire-wound	Power Film
PRS05W	PRS 5W	5W	10	9	22	0.75	5	0.1Ω ~ 47Ω	48Ω ~ 100KΩ
PRS07W	PRS 7W	7W	10	9	35	0.75	10	0.1Ω ~ 680Ω	681Ω ~ 200KΩ
PRS0AW	PRS 10W	10W	10	9	49	0.75	10	0.1Ω ~ 910Ω	911Ω ~ 200KΩ
PRS0FW	PRS 15W	15W	12.5	11.5	49	0.75	11	1Ω ~ 1KΩ	
PRS020	PRS 20W	20W	14.5	13.5	60	0.75	10	1Ω ~ 3.4KΩ	
PRS025	PRS 25W	25W	14.5	13.5	64	0.75	10	1Ω ~ 3.4KΩ	

Remark: Max Working Voltage: 500V  
Max Overload Voltage: 1,000V

# Cement Fixed Resistors

## PRS Recommended Hole

PRS 5W

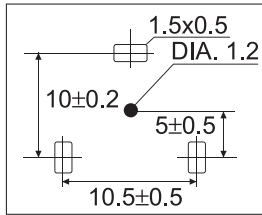

PRS 7W, 10W, 15W

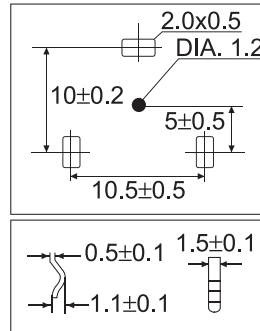

PRS 20W, 25W

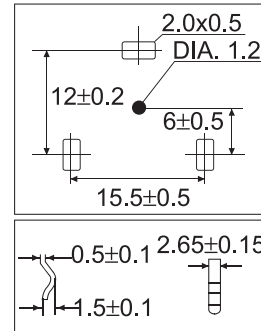

Heat Rise Chart (PRS)

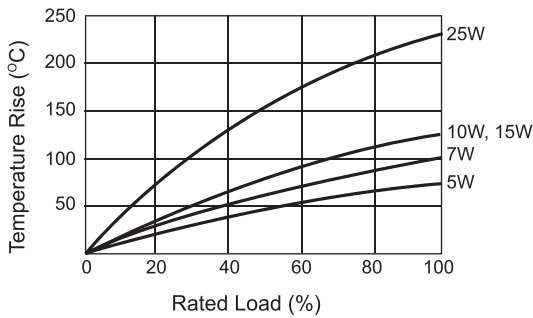

## PRZA-1, PRZA-2, PRZA-3, PRZC, PRZD Type

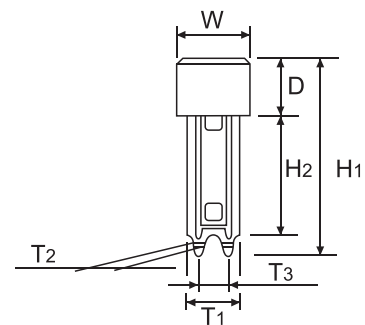
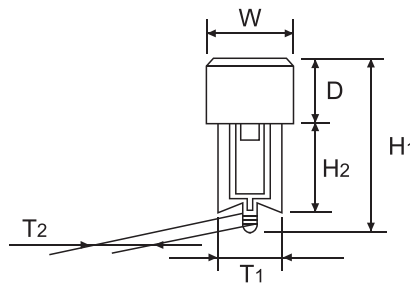
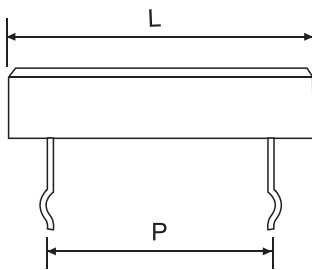

## Recommended Hole

PRZA-1, PRZA-2, PRZA-3

PRZC, PRZD

Power Rating at 70°C	Dimension (mm)		
	PRZA-1, PRZA-2, PRZA-3	PRZC, PRZD	P
5W			9.5 / 15
7W			22
10W			32 / 35
15W			32
20W			45

## X-ON Electronics

Largest Supplier of Electrical and Electronic Components

*Click to view similar products for [Royal Ohm manufacturer](#):*

Other Similar products are found below :

[0105WHF1000TDE](#) [0105WHF1004TDE](#) [0105WHF1500TDE](#) [0105WHF1503TDE](#) [0105WHF150JTDE](#) [0105WHF2201TDE](#)  
[0105WHF2202TDE](#) [0105WHF220JTDE](#) [0105WHF3301TDE](#) [0105WHF3303TDE](#) [0105WHF4700TDE](#) [0105WHF4702TDE](#)  
[0105WHJ0000TDE](#) [0105WHJ0100TDE](#) [0105WHJ0102TDE](#) [0105WHJ0103TDE](#) [0105WHJ0105TDE](#) [0105WHJ0151TDE](#)  
[0105WHJ0220TDE](#) [0105WHJ0330TDE](#) [0105WHJ0331TDE](#) [0105WHJ0472TDE](#) [0201WMF0000TEE](#) [0201WMF1000TEE](#)  
[0201WMF1001TEE](#) [0201WMF100JTEE](#) [0201WMF1500TEE](#) [0201WMF1503TEE](#) [0201WMF150JTEE](#) [0201WMF150KTEE](#)  
[0201WMF2201TEE](#) [0201WMF2202TEE](#) [0201WMF2204TEE](#) [0201WMF220JTEE](#) [0201WMF220KTEE](#) [0201WMF3301TEE](#)  
[0201WMF3302TEE](#) [0201WMF3303TEE](#) [0201WMF3304TEE](#) [0201WMF330JTEE](#) [0201WMF330KTEE](#) [0201WMF4703TEE](#)  
[0201WMF470JTEE](#) [0201WMF6801TEE](#) [0201WMF6804TEE](#) [0201WMF680JTEE](#) [0201WMJ0100TEE](#) [0201WMJ0103TEE](#)  
[0201WMJ0104TEE](#) [0201WMJ0105TEE](#)