

Gasketing profiles

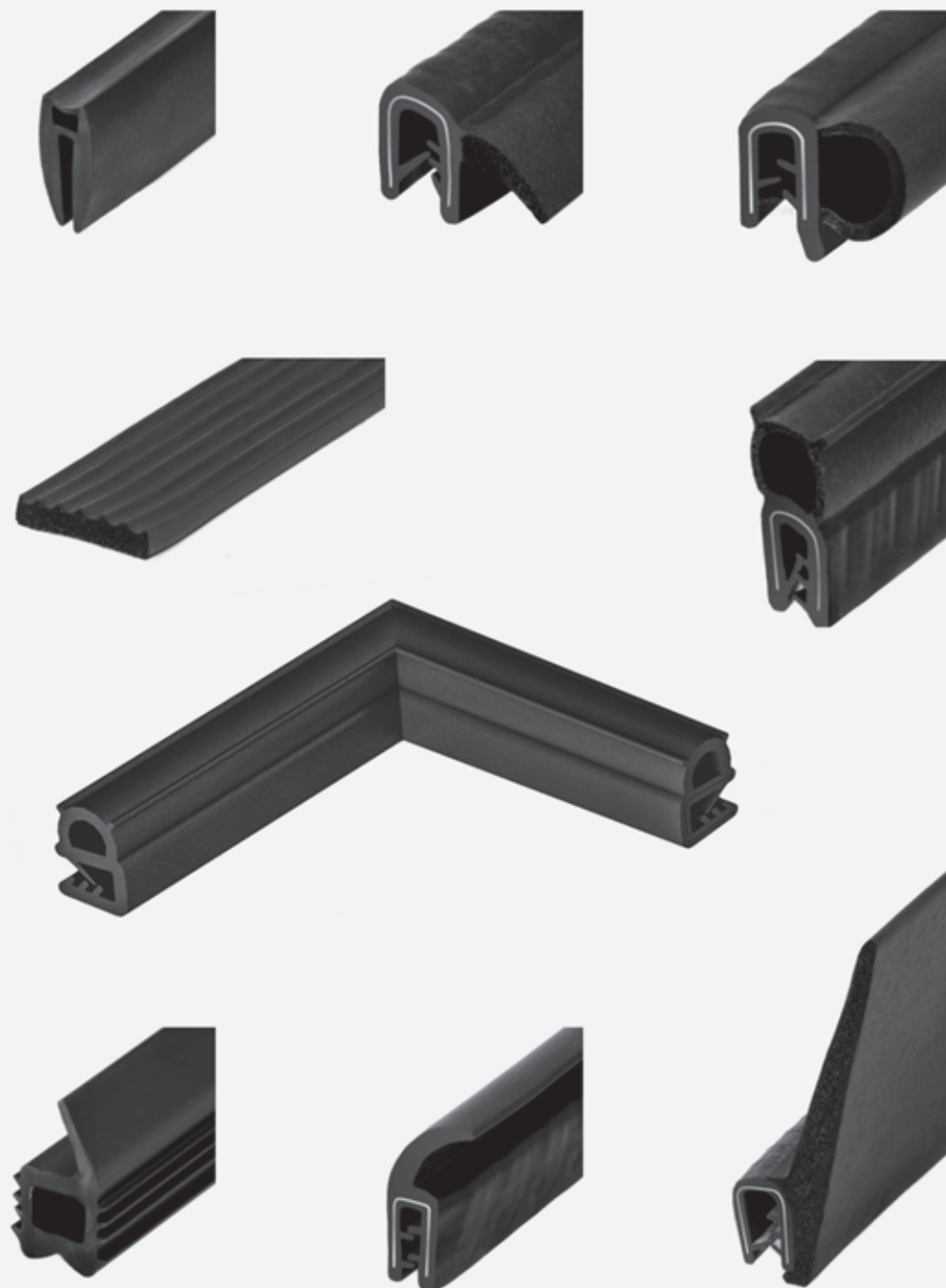

1

Locking systems

2

Locks
Latches

3

Hinges

4

Clamps

5









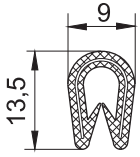

Accessories

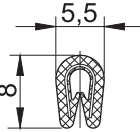
6

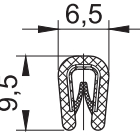
Gasketing profiles

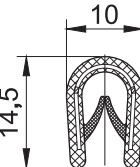
7

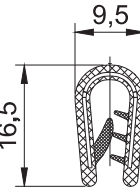
Custom products

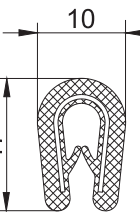
	Design (section of gasket)	Code	Clamping range [mm]	Colour	Material	Sales unit [m]
		UT-4	1,0-4,0	C	PCV	100
		UT-4.2	1,0-1,5	C	PCV	100
		UT-4.3.01	1,0-2,0	C	PCV	100
		UT-4.3.02	1,0-2,0	B	PCV	100
		UT-4.3.06	1,0-2,0	S	PCV	100
		UT-4.4.01	1,0-4,0	C	PCV	100
		UT-4.4.02	1,0-4,0	B	PCV	100
		UT-4.4.04	1,0-4,0	SC	PCV	100
		UT-4.4.05	1,0-4,0	SJ	PCV	100
		UT-4.5.2	1,0-2,5	C	PCV	100
		UT-4.5.4	2,0-4,0	C	PCV	100
		UT-4.5.6	4,0-6,0	C	PCV	100
		UT-4.6	1,0-4,0	C	PCV	100

C - black, B - white, S - gray, SJ - bright gray, SC - dark gray

* Time of delivery 5-6 weeks

	Design (section of gasket)	Code	Clamping range [mm]	Colour	Material	Sales unit [m]
		UT-4.7	2,0-5,0	C	PCV	100
		UT-4.8.2	1,0-2,5	C	PCV	100
		UT-4.8.4	2,0-4,0	C	PCV	100
		UT-4.9.01	1,0-2,0	C	PCV	100
		UT-4.9.02	1,0-2,0	B*	PCV	100
		UT-4.9.03	1,0-2,0	S	PCV	100
		UT-4.10.2	2,0-4,0	C	PCV	100
		UT-3.8	6,0-8,0	C	PCV	100
		UT-3.10	8,0-10,0	C	PCV	100
		UT-2	1,7-2,3	C	PCV	25

C - black, B - white, S - gray, SJ - bright gray, SC - dark gray

* Time of delivery 5-6 weeks

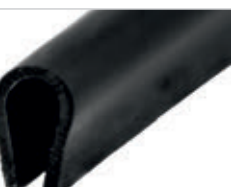
	Design (section of gasket)	Code	Clamping range [mm]	Colour	Material	Sales unit [m]
		UT-5	2,0	C	EPDM	100
		UT-5.1	3,0	C	EPDM	100
		UT-5.2	1,5	C	EPDM	100
		UT-5.3	5,0	C	EPDM	100
		UT-5.4	4,0	C	EPDM	100
		UT-5.5	5,0	C	EPDM	100
		UT-5.6	6,5	C	EPDM	100
		UT-5.7	3,0	C	EPDM	100

C - black, B - white, S - gray, SJ - bright gray, SC - dark gray

* Time of delivery 5-6 weeks

	Design (section of gasket)	Code	Clamping range [mm]	Colour	Material	Sales unit [m]
		UT-30.1	1,0-2,5	C	EPDM	50
		UT-30.4	2,0-4,0	C	EPDM	50
		UT-30.2	1,0-3,0	C	EPDM	50
		UT-35	1,0-2,5	C	EPDM	50
		UT-35.1	1,0-3,0	C	EPDM	50

C - black, B - white, S - gray, SJ - bright gray, SC - dark gray
 * Time of delivery 5-6 weeks

- EPDM - PVC

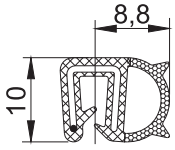
	Design (section of gasket)	Code	Clamping range [mm]	Colour	Material	Sales unit [m]
		UT-31	1,0-4,0	C	EPDM PCV	50
		UT-31.2	1,0-4,0	C	EPDM PCV	50
		UT-33.2	1,0-2,0	C	EPDM	50
		UT-33.3	1,0-2,5	C	EPDM	100

C - black, B - white, S - gray, SJ - bright gray, SC - dark gray
* Time of delivery 5-6 weeks

 - EPDM  - PVC

	Design (section of gasket)	Code	Clamping range [mm]	Colour	Material	Sales unit [m]
		UT-33.4	1,0-2,5	C	EPDM	100
		UT-34	1,0-2,0	C	EPDM PCV	100
		UT-37	0,8-2,5	C	EPDM	50
		UT-37.1	2,0	C	EPDM	50
		UT-57A	2,0	C	EPDM	50

C - black, B - white, S - gray, SJ - bright gray, SC - dark gray
 * Time of delivery 5-6 weeks

- EPDM - PVC

	Design (section of gasket)	Code	Clamping range [mm]	Colour	Material	Sales unit [m]
		UT-8	1,0-4,0	C	EPDM	25
		UT-8.2	1,5-3,0	C	EPDM	25
		UT-8.3	1,0-4,0	C	EPDM PCV	50
		UT-8.4	1,5-3,0	C	EPDM	50
		UT-8.5	2,0-5,0	C	EPDM PCV	50

C - black, B - white, S - gray, SJ - bright gray, SC - dark gray
* Time of delivery 5-6 weeks

 - EPDM  - PVC

	Design (section of gasket)	Code	Clamping range [mm]	Colour	Material	Sales unit [m]
		UT-8.6.4	2,0-4,0	C	EPDM	25
		UT-8.6.6	4,0-6,0	C	EPDM	25
		UT-8.7	1,0-3,5	C	EPDM	25
		UT-8.8	3,5-5,0	C	EPDM	3000
		UT-9.2	1,0-2,5	C	EPDM PCV	50
		UT-9.4	2,5-4,0	C	EPDM PCV	50
		UT-9.6	4,0-6,0	C	EPDM PCV	50
		UT-10.3	6,0	C	EPDM PCV	100







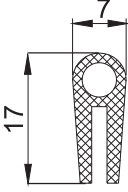

C - black, B - white, S - gray, SJ - bright gray, SC - dark gray
 * Time of delivery 5-6 weeks

- EPDM - PVC

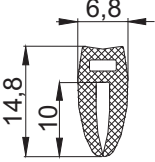
	Design (section of gasket)	Code	Clamping range [mm]	Colour	Material	Sales unit [m]
		UT-70	1,0-4,0	C	EPDM	50
		UTB-1	-	C	EPDM	100
		UTB-2	1,5	C	EPDM	5000
		UTB-9	5,0-6,0	C	EPDM	100

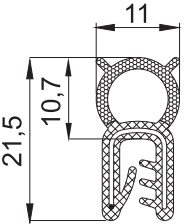

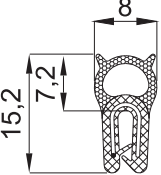

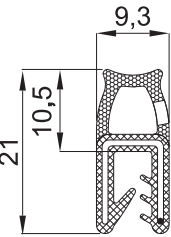

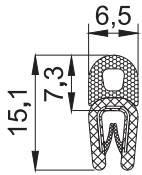

C - black, B - white, S - gray, SJ - bright gray, SC - dark gray
* Time of delivery 5-6 weeks

 - EPDM  - PVC

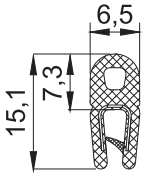
	Design (section of gasket)	Code	Clamping range [mm]	Colour	Material	Sales unit [m]
		UT-26A	2,0-3,0	C	EPDM	100
		UT-27	1,8	C	EPDM	50
		UT-32	1,0-3,0	C	EPDM	50
		UT-38	1,0-2,0	C	EPDM	50
		UT-42	0,5-1,5	C	EPDM	50
		UT-51	1,0-3,0	C	EPDM	50

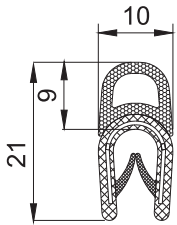
C - black, B - white, S - gray, SJ - bright gray, SC - dark gray
 * Time of delivery 5-6 weeks

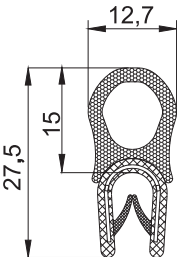
 - EPDM  - PVC

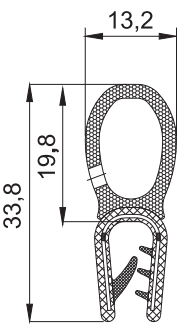
	Design (section of gasket)	Code	Clamping range [mm]	Colour	Material	Sales unit [m]
		UT-43	1,0-2,0	C	EPDM PCV	100
		UT-43B	1,0-2,0	C	EPDM	102
		UT-43.3	1,0-4,0	C	EPDM PCV	50
		UT-43.4	1,0-4,0	C	EPDM PCV	50
		UT-43.5.2	1,0-2,5	C	EPDM PCV	50
		UT-43.5.4	2,0-4,0	C	EPDM PCV	50
		UT-43.5.6	4,0-6,0	C	EPDM PCV	50







C - black, B - white, S - gray, SJ - bright gray, SC - dark gray
* Time of delivery 5-6 weeks

 - EPDM  - PVC

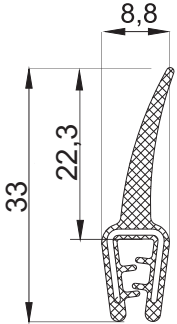
	Design (section of gasket)	Code	Clamping range [mm]	Colour	Material	Sales unit [m]
		UT-7	-	C	PCV	7x20m
		UT-7.1	-	C	PCV	7x20m
		UT-7.2	-	C	PCV	7x20m
		UT-7.3	-	C	PCV	5x20m
		UT-7.4	-	C	EPDM	100
		UT-7.5	-	C	EPDM	1500

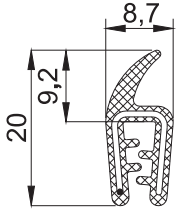
C - black, B - white, S - gray, SJ - bright gray, SC - dark gray
 * Time of delivery 5-6 weeks

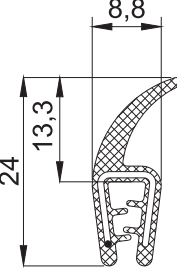
- EPDM - PVC

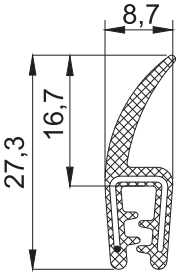
	Design (section of gasket)	Code	Clamping range [mm]	Colour	Material	Sales unit [m]
		UT-80	1,0-3,0	C	EPDM	50
		UT-80.2	1,0-2,0	C	EPDM	100
		UT-80.3	1,0-2,5	C	EPDM	100
		UT-80.4	1,0-3,0	C	EPDM	100

C - black, B - white, S - gray, SJ - bright gray, SC - dark gray
 * Time of delivery 5-6 weeks

 - EPDM  - PVC

	Design (section of gasket)	Code	Clamping range [mm]	Colour	Material	Sales unit [m]	
		USRE-10.04	-	C	EPDM	125	
		USRE-15.03	-	C	EPDM	100	
		USRE-15.04	-	C	EPDM	100	
		USRE-20.04	-	C	EPDM	50	
		USDE-14.12	-	C	EPDM	40	
		UTK-10.11	-	C	EPDM	100	
		UTK-10.12	-	C	EPDM	100	
		USDE-15.15	-	C	EPDM	100	
		No of gasket	A width (mm)	B height (mm)	C	EPDM	
		USPE-05.03	5	3			10
		USPE-08.02	8	2			200
		USPE-08.03	8	3			10
		USPE-10.02	10	2			100
		USPE-10.03	10	3			10
		USPE-10.04	10	4			15
		USPE-10.05	10	5			10/15
		USPE-12.03	12	3			10
		USPE-12.04	12	4			10
		USPE-15.03	15	3			10
		USPE-15.04	15	4			10
		USPE-16.08	16	8			5
		USPE-18.05	18	5			15
USPE-20.03	20	3	10				
USPE-20.05	20	5	10				

C - black, B - white, S - gray, SJ - bright gray, SC - dark gray

* Time of delivery 5-6 weeks

www.roztocze.eu







- EPDM

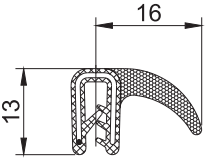
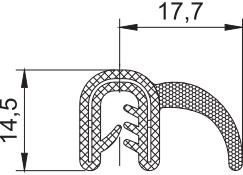

- PVC

Gasketing profiles |

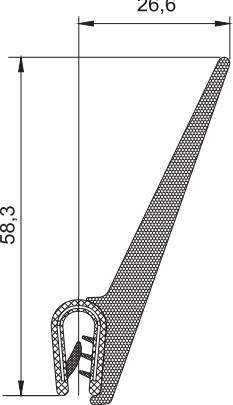
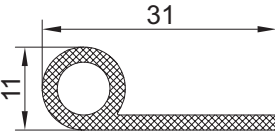
	Design (section of gasket)	Code	Clamping range [mm]	Colour	Material	Sales unit [m]
		UT-81.1	1,0-2,0	C	EPDM PCV	100
		UT-81.2	1,25-2,0	C	EPDM PCV	100
		UT-81.3	1,0-4,0	C	EPDM	50
		UT-81.4	1,0-3,5	C	EPDM	2500
		UT-81.5	1,0-2,5	C	EPDM	100
		UT-82.2	1,0-2,5	C	EPDM PCV	25
		UT-82.4	2,0-4,0	C	EPDM PCV	25
		UT-82.6	4,0-6,0	C	EPDM PCV	25
		UT-83	1,0-2,5	C	EPDM	3000
		UTP-137	-	C	EPDM	100

C - black, B - white, S - gray, SJ - bright gray, SC - dark gray

* Time of delivery 5-6 weeks

| Gasketing profiles

 - EPDM  - PVC

www.roztocze.eu

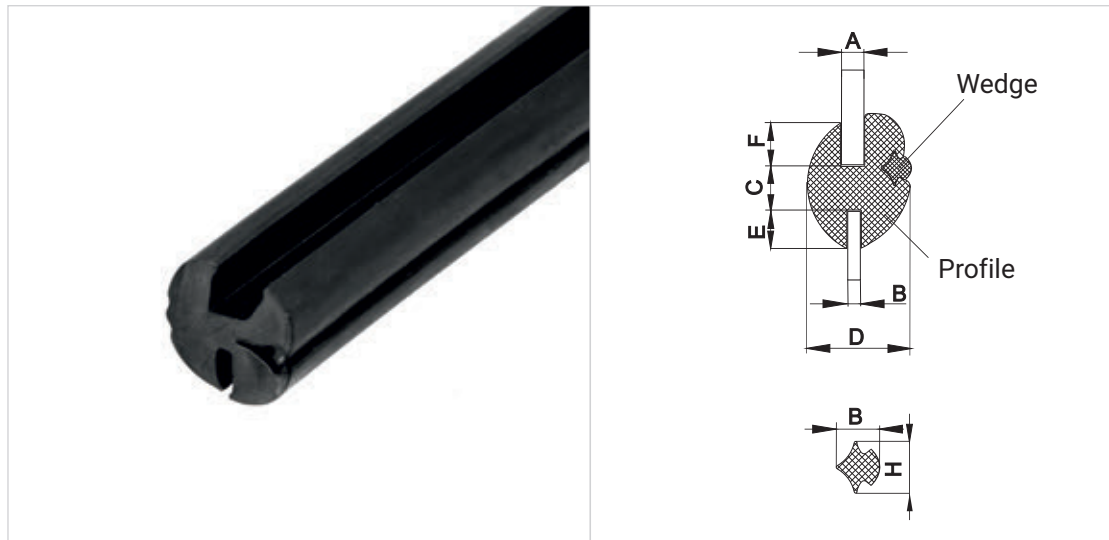









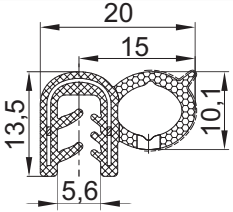

Code	A	B	C	D	E	F	Sales unit [m]	Wedge	Material
US-838	3	1	4	11.6	4.5	6	20	US-328	EPDM
US-838.2	3	2	4	10.2	3	3	50	US-328.1	
US-838.3	4	1.5	4	13.6	5	6	25	US-328	
US-838.4	4	2	7.3	18	11	8.7	15	US-328.2	
US-838.5	4	3	4	12.6	5	6	25	US-328	
US-838.6	4	3	7	16	7	7	20	US-328.2	
US-838.7	4.5	5	7	16	7	7	20	US-328.2	
US-838.8	5	2	5	15	6	6	50	US-328.2	
US-838.9	5	3	7	19	8	8	20	US-328.2	
US-838.10	6	2.5	7	19	8	8	20	US-328.2	

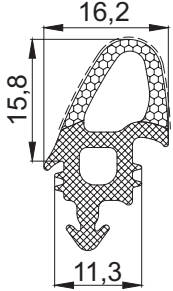
Wedge	H	B	Material	Colour
US-328	7,0	6,0	EPDM	C
US-328.1	5,5	4,5		
US-328.2	9,5	7,5		

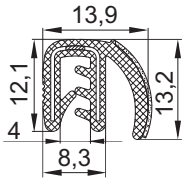

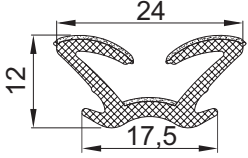

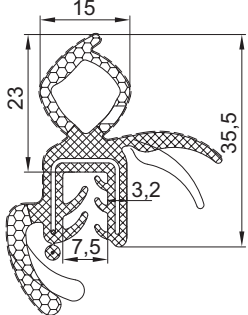

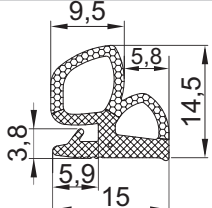

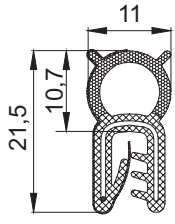

Notice:
 strengthening frame profile should be ordered
 with the wedge
 * wedge fixing tools to order with the manufacturer

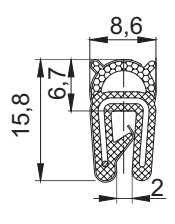

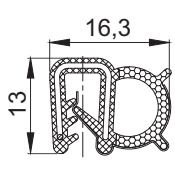
C - black, B - white, S - gray, SJ - bright gray, SC - dark gray
 * Time of delivery 5-6 weeks

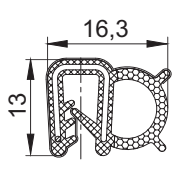
	Design (section of gasket)	Code	Clamping range [mm]	Colour	Material	Sales unit [m]
		UTG-1	3,0-4,5	C	EPDM	100
		UTG-2	-	C	EPDM	100
		UTF-1	1,0-2,5	C	EPDM	100
		UTF-2	-	C	EPDM	100
		UTGF-1	2,5-5,0	C	EPDM	100
		UTGF-2	-	C	EPDM	100

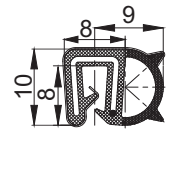
Sealing profiles with shielding electromagnetic interference / RFI signals.

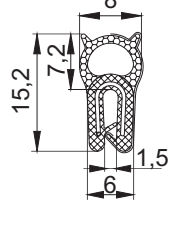
	Design (section of gasket)	Code	Clamping range [mm]	Colour	Material	Sales unit [m]
		UT-32.EMV	1,0-3,0	C	EPDM*	100
		UT-38.EMV	1,0-2,0	C	EPDM*	100
		UT-57A.EMV	2,0	C	EPDM*	100
		UT-57B.EMV	2,0	C	EPDM*	100
		UT-33.3.EMV	1,0-2,5	C	EPDM*	100
		UT-42.EMV	0,5-1,5	C	EPDM*	100

* Soft-sponge rubber with conductive overall coating and steel spring core.

C - black, B - white, S - gray, SJ - bright gray, SC - dark gray



* Time of delivery 5-6 weeks

www.roztocze.eu

Gasketing profiles |

Sealing profiles from UR group meets railway norm **EN 45545-2**

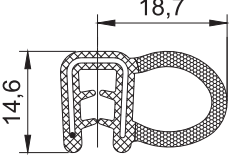

solid rubber (50,60,70 Shore A), classification R22/R23 HL3
sponge rubber (density 0,8 g / cm³), classification R22/R23 HL2

	Design (section of gasket)	Code	Clamping range [mm]	Colour	Material	Sales unit [m]
		UR-4.9.01	1,0-2,0	C	EPDM	100
		UR-4.4.01	1,0-4,0	C	Hexflame 45-1000	100
		UR-8.2	1,5-3,0	C	EPDM	100
		UR-8.8	1,0-3,0	C	PCV	100

C - black, **B** - white, **S** - gray, **SJ** - bright gray, **SC** - dark gray
* Time of delivery 5-6 weeks

Sealing profiles from UR group meets railway norm EN 45545-2

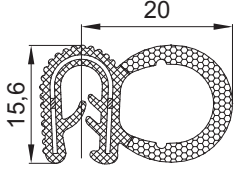

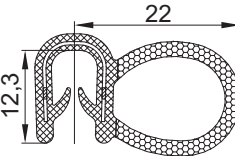
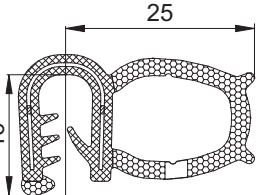

solid rubber (50,60,70 Shore A), classification R22/R23 HL3
 sponge rubber (density 0,8 g / cm³), classification R22/R23 HL2

	Design (section of gasket)	Code	Clamping range [mm]	Colour	Material	Sales unit [m]
		UR-8.9	2,0-3,5	C	PCV	100
		UR-8.10	1,0-4,0	C	PCV	100
		UR-8.11	1,0-4,0	C	PCV	100
		UR-8.12	3,0-4,5	C	PCV	on request

C - black, **B** - white, **S** - gray, **SJ** - bright gray , **SC** - dark gray
 * Time of delivery 5-6 weeks

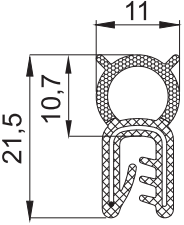
Sealing profiles from UR group meets railway norm **EN 45545-2**

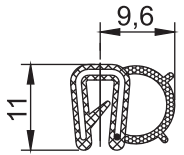

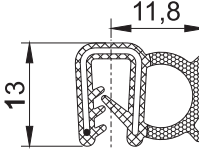



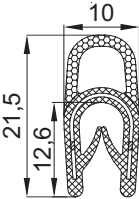

solid rubber (50,60,70 Shore A), classification R22/R23 HL3
sponge rubber (density 0,8 g / cm³), classification R22/R23 HL2

	Design (section of gasket)	Code	Clamping range [mm]	Colour	Material	Sales unit [m]
		UR-32	1,0-3,0	C	EPDM	100
		UR-33.2	1,0-2,0	C	EPDM	100
		UR-38	1,0-2,0	C	EPDM	100
		UR-57A	2,0	C	EPDM	100

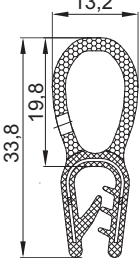
C - black, **B** - white, **S** - gray, **SJ** - bright gray, **SC** - dark gray
* Time of delivery 5-6 weeks

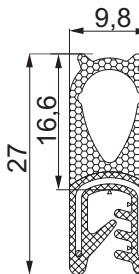
Sealing profiles from UR group meets railway norm EN 45545-2

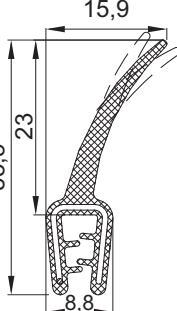

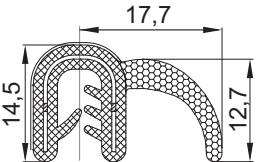



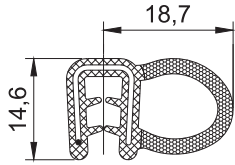

solid rubber (50,60,70 Shore A), classification R22/R23 HL3
 sponge rubber (density 0,8 g / cm³), classification R22/R23 HL2

	Design (section of gasket)	Code	Clamping range [mm]	Colour	Material	Sales unit [m]
		UR-43.3	1,0-4,0	C	PCV	on request
		UR-43.5	1,5-3,0	C	PCV	on request
		UR-43.6	2,0-4,0	C	EPDM	100
		UR-80.5	1,0-2,0	C	PCV	on request
		UR-81.3	1,25-2,0	C	PCV	on request

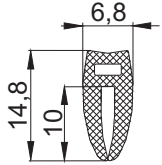
C - black, B - white, S - gray, SJ - bright gray, SC - dark gray

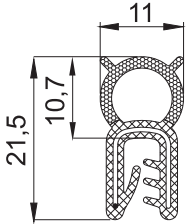
* Time of delivery 5-6 weeks

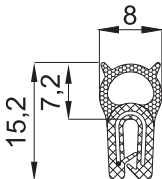
VDI 6022 - standard defining hygienic requirements for air handling units and air-conditioning units

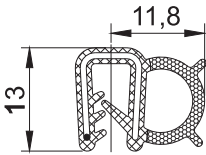
	Design (section of gasket)	Code	Clamping range [mm]	Colour	Material	Sales unit [m]
		UT-8.2.VDI	1,5-3,0	C	EPDM	25
		UT-27.VDI	1,8	C	EPDM	50
		UT-32.VDI	1,0-3,0	C	EPDM	50
		UT-42.VDI	0,5-1,5	C	EPDM	50
		UT-57A.VDI	2,0	C	EPDM	50

X-ON Electronics

Largest Supplier of Electrical and Electronic Components

Click to view similar products for [Electrical Enclosure Accessories](#) category:

Click to view products by [Roztocze](#) manufacturer:

Other Similar products are found below :

[60121-06-028 C-325 Black](#) [71884-04-028 CM3-100 Black](#) [71884-18-028 LH43-200 Black](#) [71884-24-028 LH75-200 Black](#) [71885-01-028 CM6-150 Black](#) [72459-02-028 DM-3 BLACK](#) [72459-03-028 DM-4 BLACK](#) [81501-01-000 XPL, 9VB Black](#) [82402-01 PT-8 ALUM](#) [83541307GSKTSC](#) [1335GSKT3](#) [14101FP-PK](#) [BAS-5104](#) [CB-1263-BT](#) [HM BLACK PANEL](#) [61033-01-000](#) [115123-01-508 CN-RL RS](#) [115124-01-508 CN-XRL XRS](#) [115119-01-000 CN-RL RS](#) [115123-01-000 CN-RL RS](#) [60121-04-028 C-275 Black](#) [60128-01-072](#) [60222-01-028 CM6-225 Black](#) [60272-01-028 CM3-150 Black](#) [60851-01-028 CM69-120 Black](#) [62452-01-000 HML-9VB, EB Black](#) [71884-25-028 LH89-130 Black](#) [AXX2POSTBRCKT](#) [FUPMESK](#) [71884-23-028 LH75-130 Black](#) [8G813V40365](#) [8G813V40367](#) [8G813V40389](#) [8G820V40620](#) [DVC.2-40-33-30-M8-23-40](#) [96178](#) [096484E](#) [GN 963-45-45-45-SW](#) [GN 967-20-20-L-2-ZB](#) [1.325.1300.20](#) [52023608](#) [53801090](#) [53801115](#) [AXX2POSTBRCKT 918808](#) [OBOX-385-NBR-M](#) [60242-02-028 CM5-200 Black](#) [DIN 7603-AL-14-18-A](#) [DIN 7603-AL-16-20-A](#) [DIN 7603-AL-20-24-A](#) [DIN 7603-AL-24-29-A](#)