

REV.	MODIFICATION.	DATE	DRN
01	NEW DRAWING	07/08/06	NJB
02	CO2011054	09/02/11	SF
03	CO2011253	13/04/12	SF

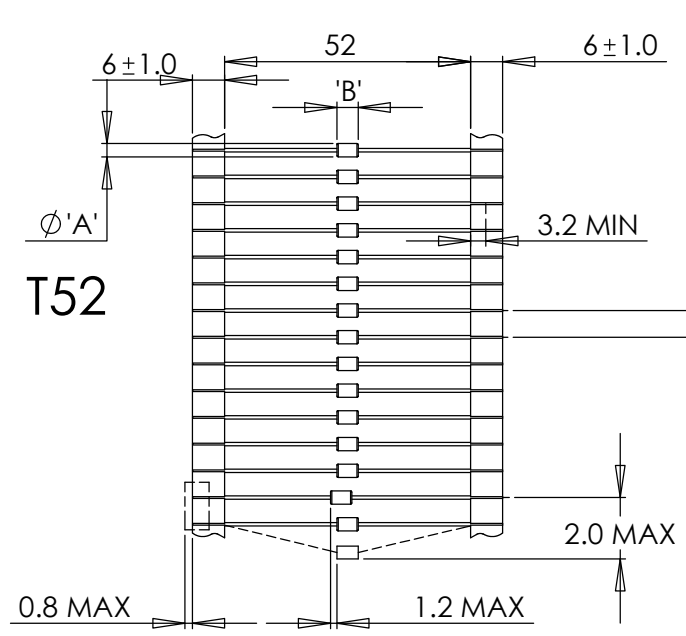
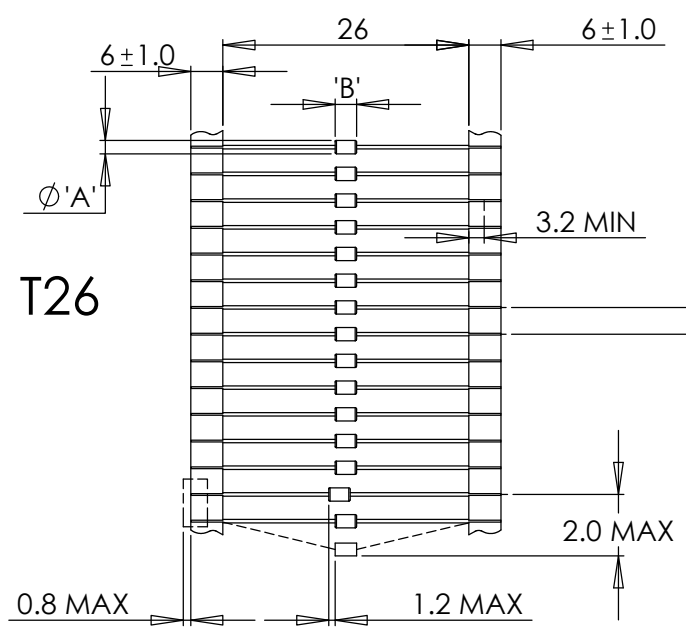

FERRITE MATERIAL: K5B • GLUE: RMS-301 • WIRE: RMS-308

PART NUMBER	A	B	IMPEDANCE(Ω)		STANDARD PACK SIZE			
			100MHz	25MHz				
RRHL-25-30-8T52	2.50±0.15	3.00±0.20	27	47	5000			
RRHL-25-40-8T52		4.00±0.30	32	51				
RRHL-25-70-8T52		7.00±0.30	56	89				
RRHL-35-30-8T52	3.50±0.15	3.00±0.20	33	59				
RRHL-35-32-8T52		3.20±0.20	31	57				
RRHL-35-35-8T52		3.50±0.15	37	63				
RRHL-35-45-8T26		4.50±0.30	4.50±0.30	39		76	1000	
RRHL-35-45-8T52			4.50±0.30	47		76	5000	
RRHL-35-47-8T26			4.70±0.30	4.70±0.30		46	72	2000
RRHL-35-47-8T52		4.70±0.30		49		79	5000	
RRHL-35-50-8T26		5.00±0.30		5.00±0.30	47	72	2000	
RRHL-35-50-8T52			5.00±0.30	50	85	5000		
RRHL-35-60-8T26			6.00±0.30	6.00±0.30	55	84	2000	
RRHL-35-60-8T52	6.00±0.30	57		84	5000			
RRHL-35-67-8T52	6.70±0.30	65		99				
RRHL-35-75-8T52	3.50±0.15	7.50±0.30	68	113	5000			
RRHL-35-80-8T26		8.00±0.30	8.00±0.30	70		125	1000	
RRHL-35-80-8T52			8.00±0.30	88	138	5000		
RRHL-35-83-8T52		8.30±0.30	8.30±0.30	74	131		5000	
RRHL-35-90-8T26			9.00±0.30	9.00±0.30	85	150		1000
RRHL-35-90-8T52				9.00±0.30	92	140		5000
RRHL-35-95-8T52		9.50±0.40	99	157				
RRHL-35-100-8T52		10.00±0.40	99	157				
RRHL-35-114-8T52		11.40±0.40	105	165				
RRHL-35-140-8T52		14.00±0.40	144	212				

- NOTES.  
1) See drawing 06-086 sheets 2 & 3 of 3 for Impedance graphs.  
2) Impedance figures are typical values.  
3) other sizes available by special order.  
4) Packaging information is only a guide & subject to variation.

INFORMATION CONTAINED IN THIS DOCUMENT IS CONFIDENTIAL TO RICHCO INTERNATIONAL Co. Ltd. AND MAY NOT BE DISCLOSED OR REPRODUCED IN WHOLE OR PART WITHOUT THEIR WRITTEN CONSENT.

**RICHCO, INC.**  
WWW.RICHCO-INC.COM

ALL DIMENSIONS IN MM  
GENERAL TOLERANCES ±0.25  
UNLESS OTHERWISE STATED  
1 DECIMAL PLACE ±  
2 DECIMAL PLACES ±  
ANGULAR ±1°

THIRD ANGLE

MATERIAL: See Table COLOUR: See Table

DESCRIPTION: RRHL Ferrite Bead Cores, Axial taped type. PART No: See Table

DRG No: 06-086 NPR No: Mass:(g) SHEET SIZE A3

DRN NJB DATE 07/08/06 CHKD AS DATE 07/08/06 SCALE NTS SHEET No. 1 OF 3

REV.	MODIFICATION.	DATE	DRN
01	NEW DRAWING	07/08/06	NJB
02	CO2011054	09/02/11	SF
03	CO2011253	13/04/12	SF

RRHL-25-30-8T52

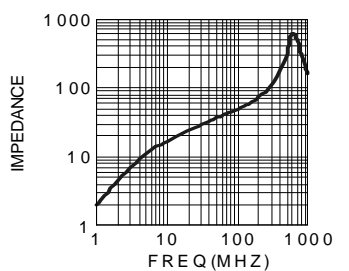

RRHL-25-40-8T52

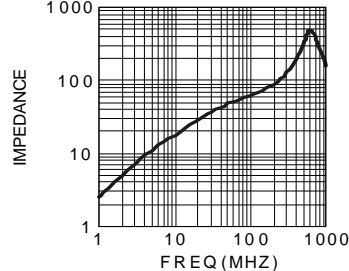

RRHL-25-70-8T52

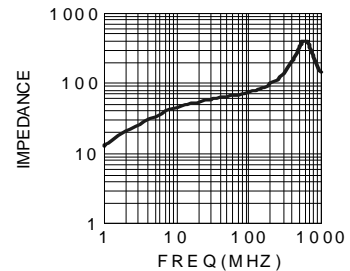

RRHL-35-30-8T52

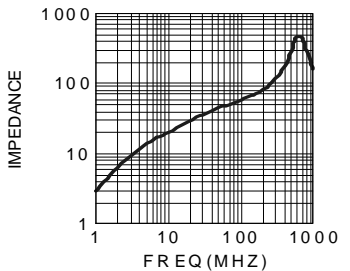

RRHL-35-32-8T52

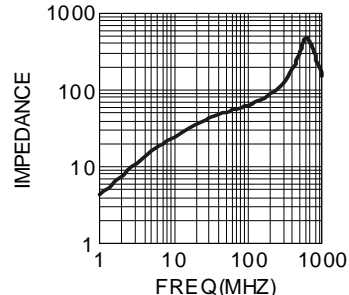

RRHL-35-35-8T52

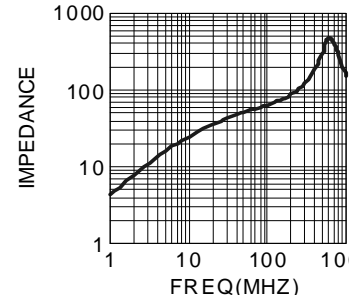

RRHL-35-45-8T26

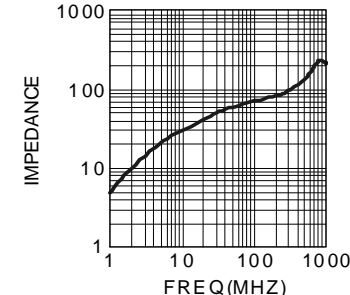

RRHL-35-45-8T52

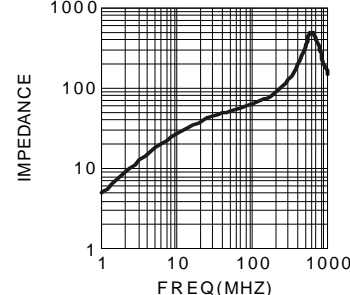

RRHL-35-47-8T26

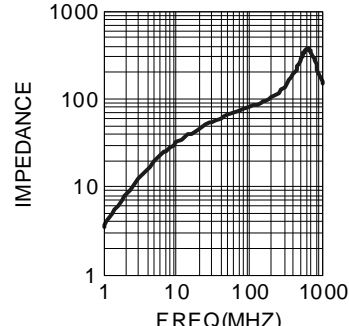

RRHL-35-47-8T52

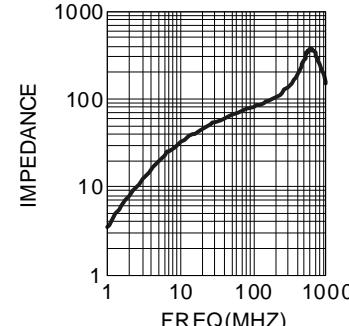

RRHL-35-50-8T26

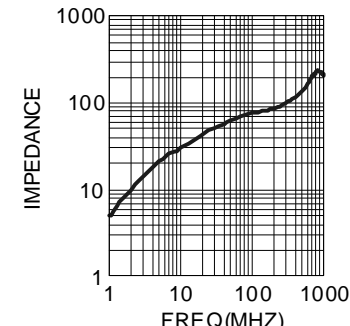

RRHL-35-50-8T52

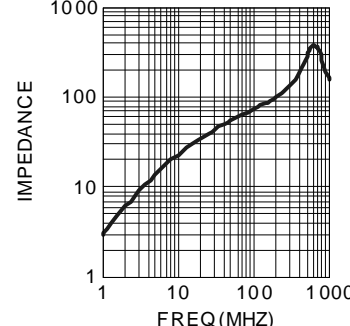

RRHL-35-60-8T26

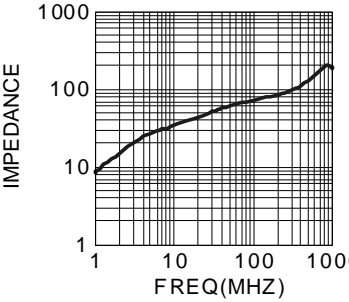

RRHL-35-60-8T52

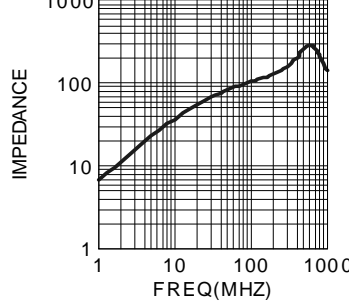

RRHL-35-67-8T52

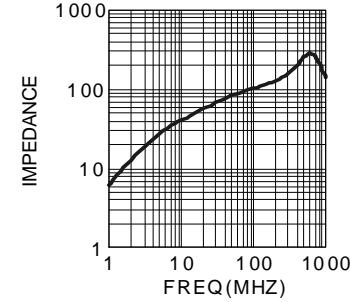

RRHL-35-75-8T52

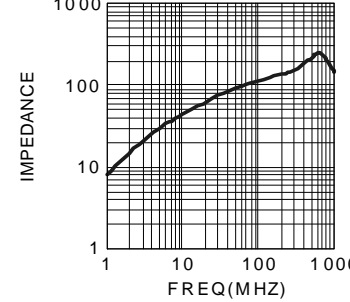

NOTES.  
1) Impedance figures are typical values.

INFORMATION CONTAINED IN THIS DOCUMENT IS CONFIDENTIAL TO RICHCO INTERNATIONAL Co. Ltd. AND MAY NOT BE DISCLOSED OR REPRODUCED IN WHOLE OR PART WITHOUT THEIR WRITTEN CONSENT.

**RICHCO, INC.**  
WWW.RICHCO-INC.COM

DESCRIPTION:  
RRHL Ferrite bead cores - Axial taped type  
Impedance graphs

DRG No: 06-086				SHEET SIZE A3	
DRN NJB	DATE 07/08/06	CHKD AS	DATE 07/08/06	SCALE NTS	SHEET No. 2 OF 3

REV.	MODIFICATION.	DATE	DRN
01	NEW DRAWING	07/08/06	NJB
02	CO2011054	09/02/11	SF
03	CO2011253	13/04/12	SF

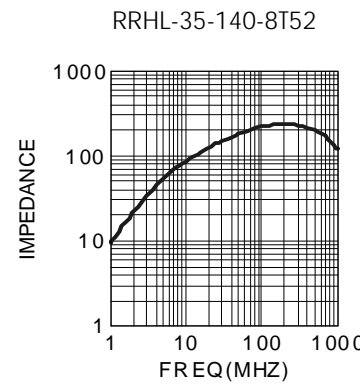
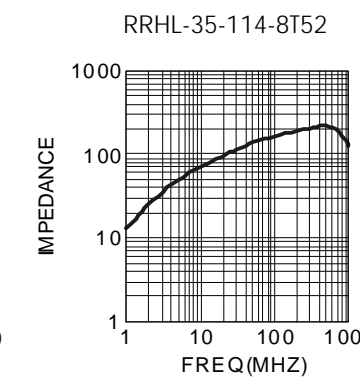
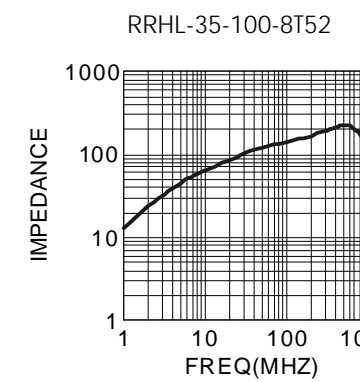
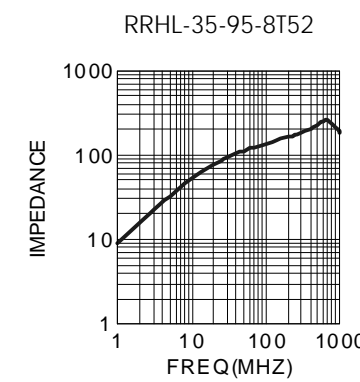
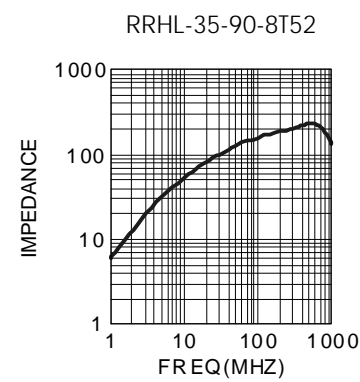
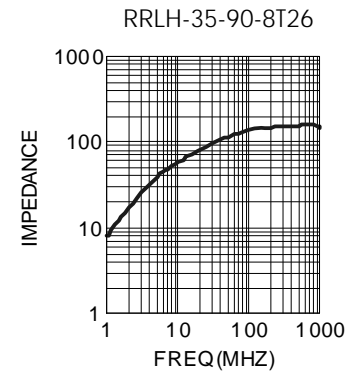
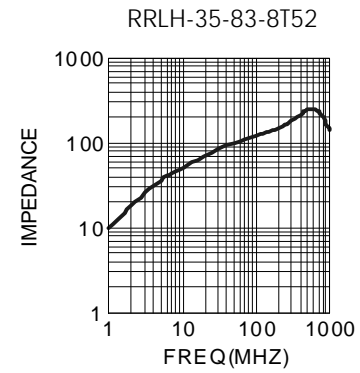
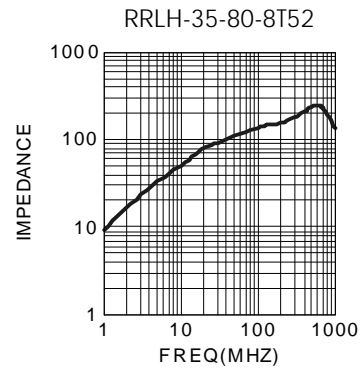
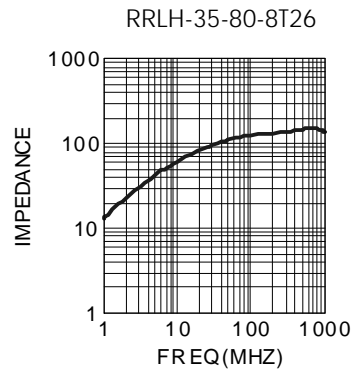

NOTES.  
1) Impedance figures are typical values.

INFORMATION CONTAINED IN THIS DOCUMENT IS CONFIDENTIAL TO RICHCO INTERNATIONAL Co. Ltd. AND MAY NOT BE DISCLOSED OR REPRODUCED IN WHOLE OR PART WITHOUT THEIR WRITTEN CONSENT.

**RICHCO, INC.**  
WWW.RICHCO-INC.COM

DESCRIPTION:  
RRHL Ferrite bead cores - Axial taped type  
Impedance graphs

DRG No:	06-086	SHEET SIZE	A3
---------	--------	------------	----

DRN	DATE	CHKD	DATE	SCALE	SHEET No.
NJB	07/08/06	AS	07/08/06	NTS	3 OF 3

## X-ON Electronics

Largest Supplier of Electrical and Electronic Components

*Click to view similar products for [Ferrite Beads](#) category:*

*Click to view products by [Richco](#) manufacturer:*

Other Similar products are found below :

[2943778301](#) [BMB1J0120BN3JIT](#) [82350120560](#) [0261014605](#) [2643066902](#) [3061000011](#) [2673045901](#) [2643083601](#) [2643074901](#) [4361142521](#)  
[4078078621](#) [4078044821](#) [4078033621](#) [CZB2BFTTE121P](#) [BMB2A0120AN2](#) [BMB1J0200BN3JIT](#) [EMI0805R-220](#) [74279250](#) [7427924](#)  
[CZB1JGTTD202P](#) [MAF0603GWY551AT000](#) [MAF1005GWZ102AT000](#) [BLM18HE152SH1D](#) [2944778302](#) [BLM02PX600SN1D](#) [SMB2.5-1](#)  
[EMI1206R-600](#) [BLM02KX180SN1D](#) [BLM02BC100SN1D](#) [BLM02KX100SN1D](#) [BLM02BB101SN1D](#) [BLM02BC220SN1D](#)  
[BLE32PN260SH1L](#) [BLE32PN260SN1L](#) [BLE32PN260SZ1L](#) [74275013](#) [7427503](#) [BLM18HE601SH1D](#) [BLM15BD152SN1D](#)  
[BLM15BD152SZ1D](#) [BLE18PS080SZ1D](#) [BLM21PG221BH1D](#) [WLBD1005HCU330TL](#) [BLM21AG471BH1D](#) [BLE18PS080BH1D](#)  
[BLM21AG331BH1D](#) [BLM21PG300BH1D](#) [BLM21PG600BH1D](#) [BLM03HB401SZ1D](#) [BLM03HB401SN1D](#)