

Features

- -12V/-4A,
 $R_{DS(ON)} = 28m\Omega(Typ.)@V_{GS} = -4.5V$
 $R_{DS(ON)} = 35m\Omega(Typ.)@V_{GS} = -2.5V$
- Low On-Resistance
- ESD protected
- Reliable and Rugged
- Lead Free and Green Devices Available (RoHS Compliant)

Applications

- Load Switch
- Power Management
- Battery Protection

Pin Description

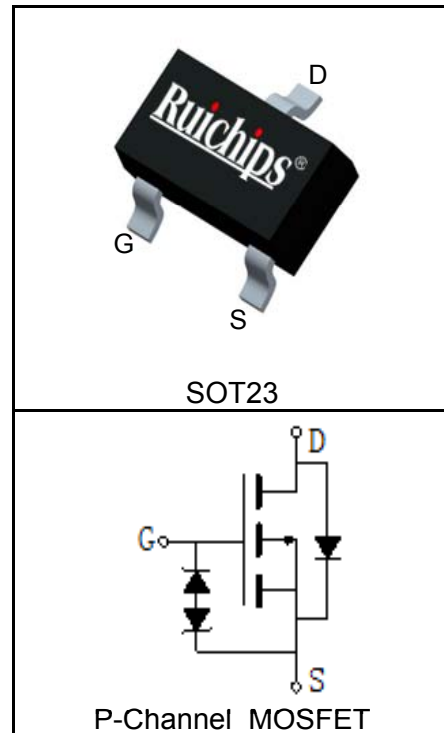

Absolute Maximum Ratings

Symbol	Parameter	Rating	Unit
Common Ratings ($T_A = 25^\circ C$ Unless Otherwise Noted)			
V_{DSS}	Drain-Source Voltage	-12	V
V_{GSS}	Gate-Source Voltage	± 10	
T_J	Maximum Junction Temperature	150	$^\circ C$
T_{STG}	Storage Temperature Range	-55 to 150	$^\circ C$
I_S	Diode Continuous Forward Current	$T_A = 25^\circ C$ -1	A
Mounted on Large Heat Sink			
$I_{DP}^{①}$	300 μs Pulse Drain Current Tested	$T_A = 25^\circ C$ -16	A
$I_D^{②}$	Continuous Drain Current ($V_{GS} = -4.5V$)	$T_A = 25^\circ C$ -4	A
		$T_A = 70^\circ C$ -3.2	
P_D	Maximum Power Dissipation	$T_A = 25^\circ C$ 1.3	W
		$T_A = 70^\circ C$ 0.8	
$R_{\theta JC}$	Thermal Resistance-Junction to Case	-	$^\circ C/W$
$R_{\theta JA}^{③}$	Thermal Resistance-Junction to Ambient	125	$^\circ C/W$
Drain-Source Avalanche Ratings			
$E_{AS}^{④}$	Avalanche Energy, Single Pulsed	TBD	mJ

Electrical Characteristics ($T_A=25^\circ\text{C}$ Unless Otherwise Noted)

Symbol	Parameter	Test Condition	RU3415B			Unit
			Min.	Typ.	Max.	
Static Characteristics						
BV_{DSS}	Drain-Source Breakdown Voltage	$V_{GS}=0V, I_{DS}=-250\mu A$	-12	-16		V
I_{DSS}	Zero Gate Voltage Drain Current	$V_{DS}=-12V, V_{GS}=0V$			-1	μA
		$T_J=125^\circ\text{C}$			-30	
$V_{GS(th)}$	Gate Threshold Voltage	$V_{DS}=V_{GS}, I_{DS}=-250\mu A$	-0.4		-1	V
I_{GSS}	Gate Leakage Current	$V_{GS}=\pm 10V, V_{DS}=0V$			± 10	μA
$R_{DS(ON)}^{(5)}$	Drain-Source On-state Resistance	$V_{GS}=-4.5V, I_{DS}=-4A$		28	40	$m\Omega$
		$V_{GS}=-2.5V, I_{DS}=-3A$		35	50	$m\Omega$
Diode Characteristics						
$V_{SD}^{(5)}$	Diode Forward Voltage	$I_{SD}=-1A, V_{GS}=0V$			-1.2	V
t_{rr}	Reverse Recovery Time	$I_{SD}=-4A, dI_{SD}/dt=100A/\mu s$		19		ns
Q_{rr}	Reverse Recovery Charge			26		nC
Dynamic Characteristics ⁽⁶⁾						
R_G	Gate Resistance	$V_{GS}=0V, V_{DS}=0V, F=1\text{MHz}$		1.6		Ω
C_{iss}	Input Capacitance	$V_{GS}=0V,$ $V_{DS}=-8V,$ Frequency=1.0MHz		640		pF
C_{oss}	Output Capacitance			115		
C_{rss}	Reverse Transfer Capacitance			75		
$t_{d(ON)}$	Turn-on Delay Time	$V_{DD}=-8V, I_{DS}=-4A,$ $V_{GEN}=-4.5V, R_G=6\Omega$		9		ns
t_r	Turn-on Rise Time			16		
$t_{d(OFF)}$	Turn-off Delay Time			29		
t_f	Turn-off Fall Time			19		
Gate Charge Characteristics ⁽⁶⁾						
Q_g	Total Gate Charge	$V_{DS}=-10V, V_{GS}=-4.5V,$ $I_{DS}=-4A$		9.5		nC
Q_{gs}	Gate-Source Charge			1.8		
Q_{gd}	Gate-Drain Charge			2.9		

- Notes:
- ① Pulse width limited by safe operating area.
 - ② Calculated continuous current based on maximum allowable junction temperature.
 - ③ When mounted on 1 inch square copper board, $t \leq 10\text{sec}$. The value in any given application depends on the user's specific board design.
 - ④ Limited by T_{Jmax} . Starting $T_J = 25^\circ\text{C}$.
 - ⑤ Pulse test; Pulse width $\leq 300\mu s$, duty cycle $\leq 2\%$.
 - ⑥ Guaranteed by design, not subject to production testing.

Ordering and Marking Information

Device	Marking	Package	Packaging	Quantity	Reel Size	Tape
RU3415B	RU3415	SOT23	Tape&Reel	3000	7"	8mm

Typical Characteristics

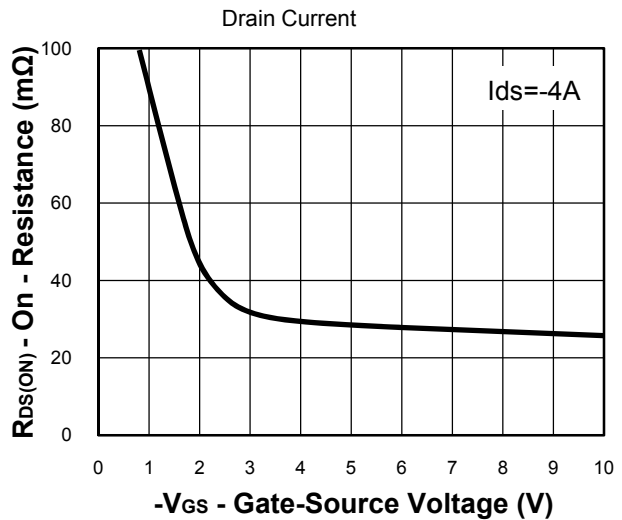
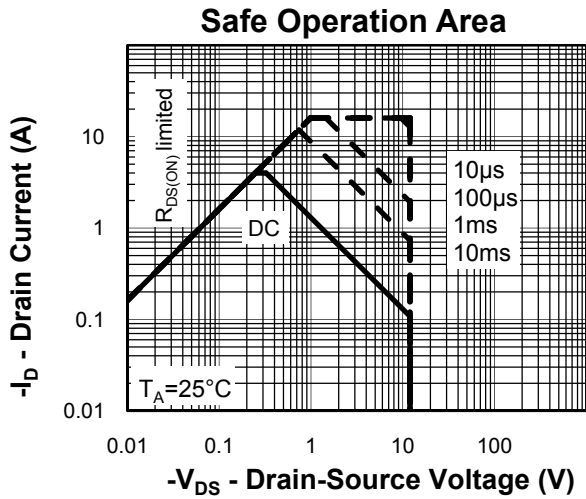
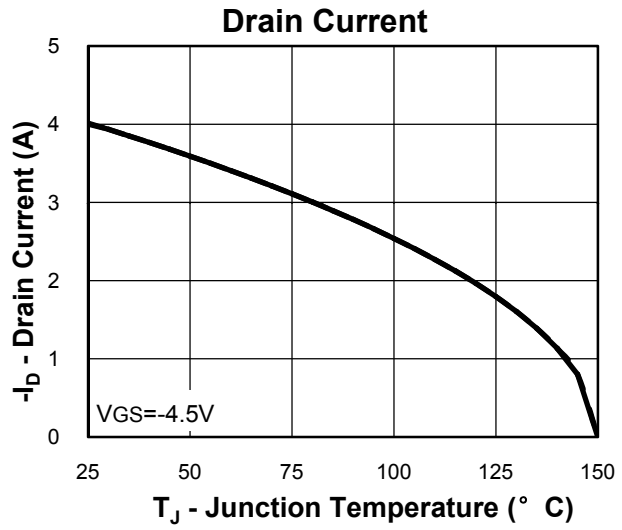
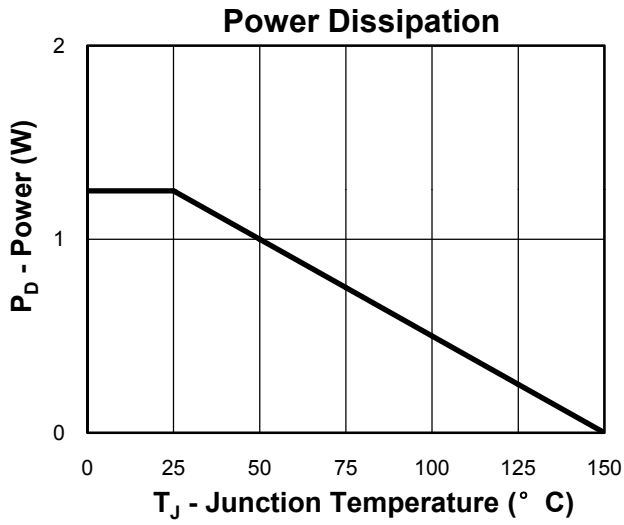

Thermal Transient Impedance

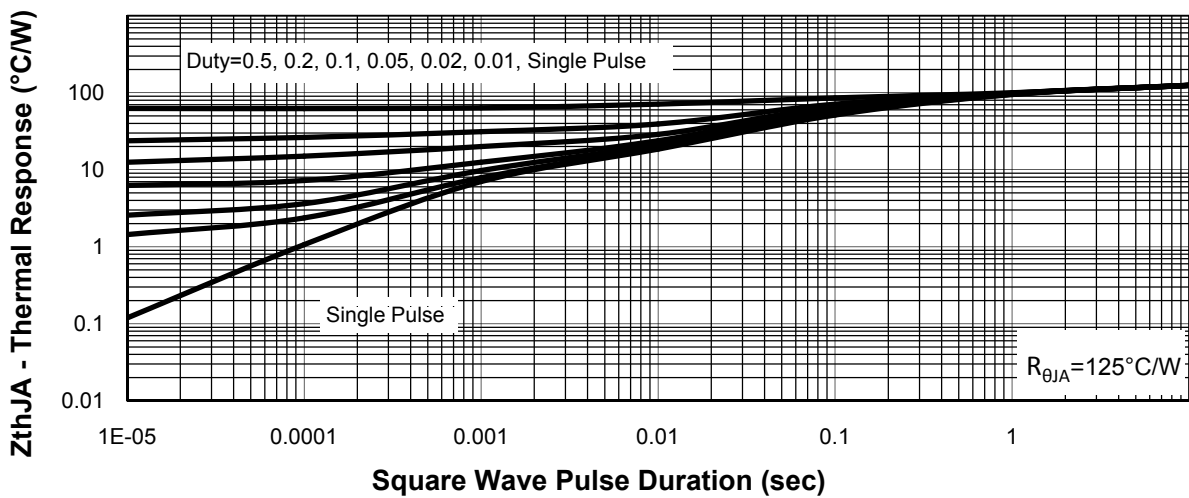

Typical Characteristics

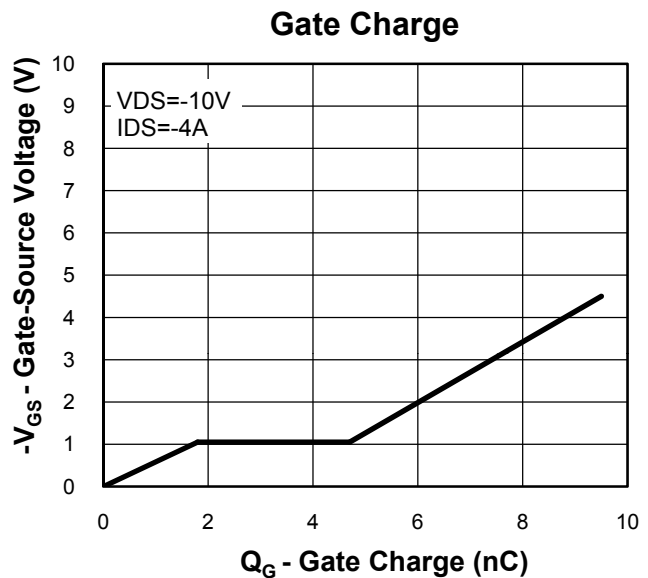
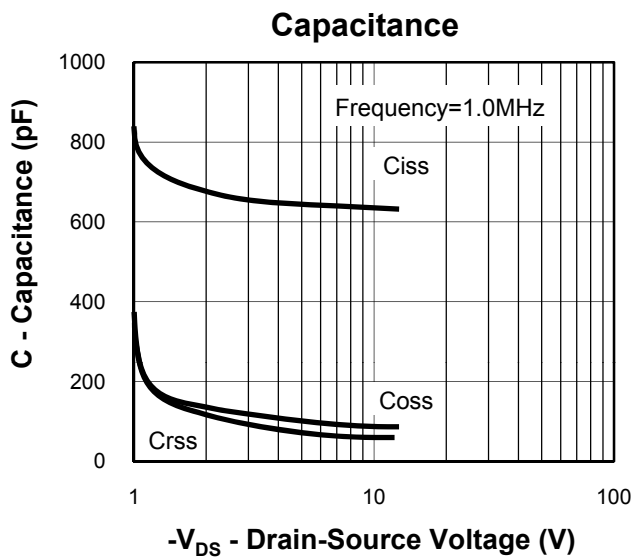
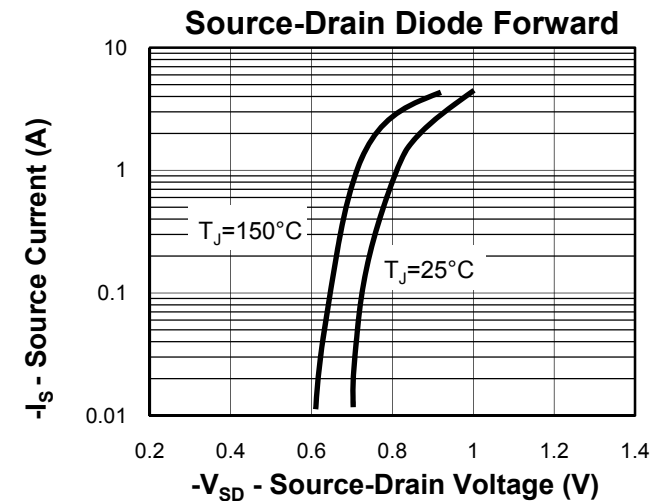
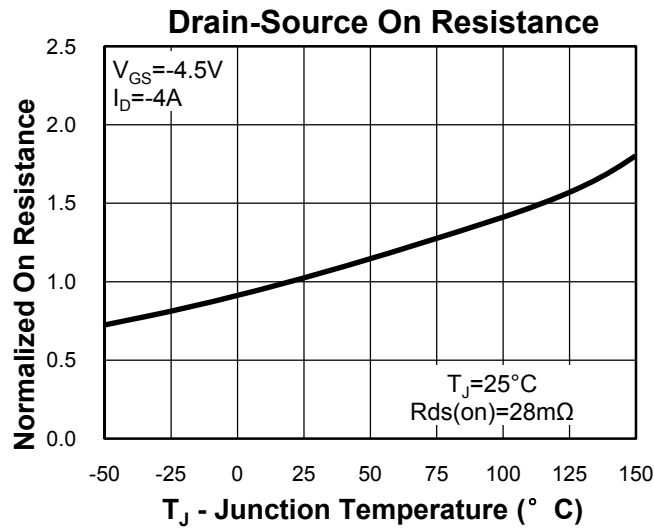
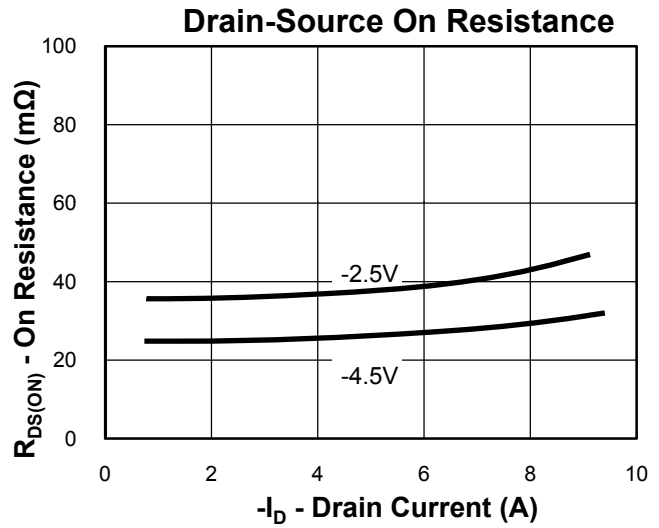
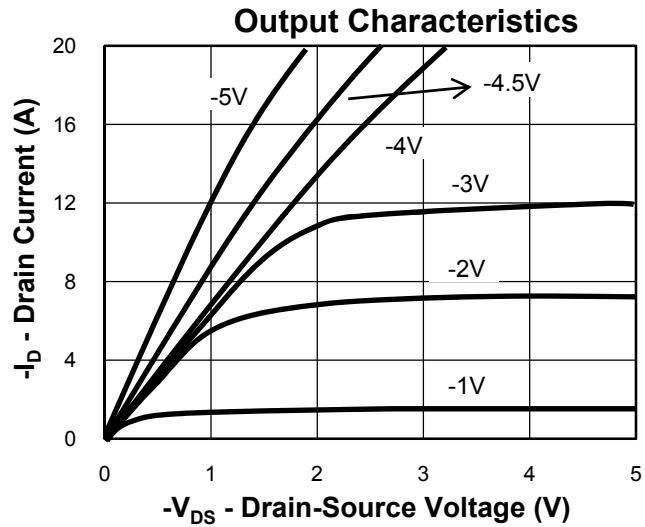

Avalanche Test Circuit and Waveforms

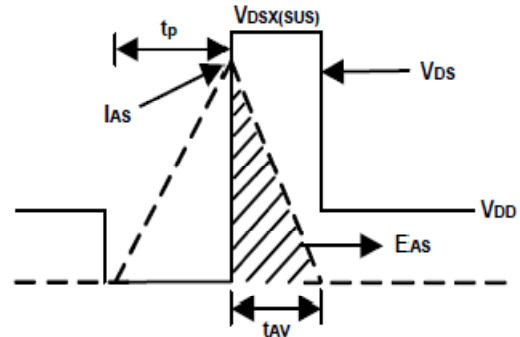
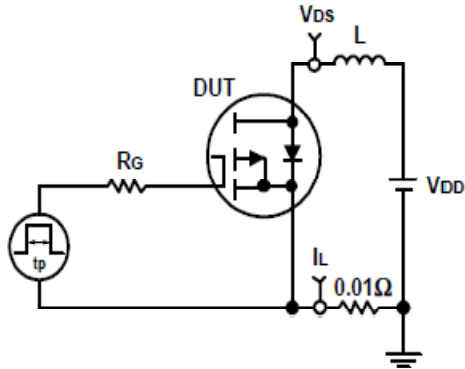

Switching Time Test Circuit and Waveforms

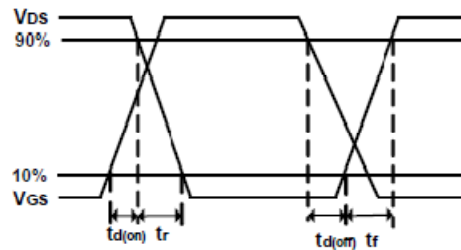
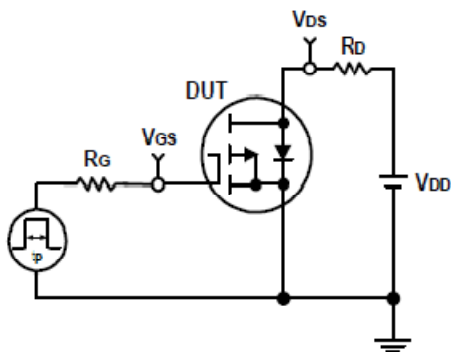

Package Information

SOT23

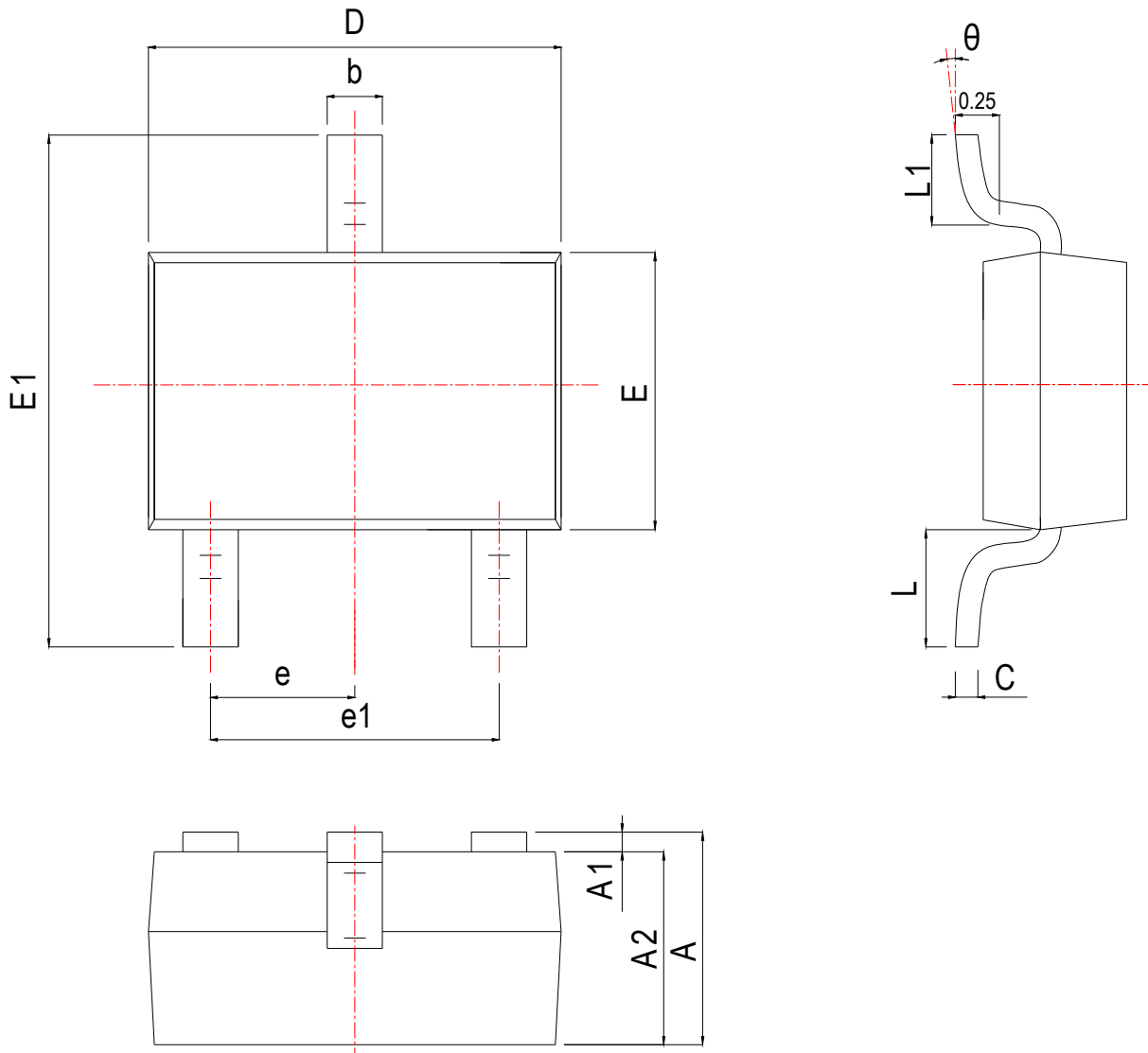

SYMBOL	MM			INCH		
	MIN	NOM	MAX	MIN	NOM	MAX
A	0.900	1.025	1.150	0.035	0.040	0.045
A1	0.050	0.075	0.100	0.002	0.003	0.004
A2	0.900	0.975	1.020	0.035	0.038	0.040
b	0.300	0.400	0.500	0.012	0.016	0.020
c	0.080	0.115	0.150	0.003	0.005	0.006
D	2.800	2.900	3.000	0.110	0.114	0.118
E	1.200	1.300	1.400	0.047	0.051	0.055
E1	2.250	2.400	2.550	0.089	0.094	0.100
e	0.950 TYP			0.037 TYP		
e1	1.800	1.900	2.000	0.071	0.075	0.079
L	0.540 REF			0.021 REF		
L1	0.400	0.500	0.600	0.016	0.018	0.020
θ	0°	*	8°	0°	*	8°

Customer Service

Worldwide Sales and Service:
Sales@ruichips.com

Technical Support:
Technical@ruichips.com

Investor Relations Contacts:
Investor@ruichips.com

Marcom Contact:
Marcom@ruichips.com

Editorial Contact:
Editorial@ruichips.com

HR Contact:
HR@ruichips.com

Legal Contact:
Legal@ruichips.com

Shen Zhen RUICHIPS Semiconductor CO., LTD
4th Floor, Block 8, Changyuan New Material Port, Keyuan Middle Road, Science & Industry Park,
Nanshan District, Shenzhen, CHINA

TEL: (86-755) 8311-5334
FAX: (86-755) 8311-4278
E-mail: Sales-SZ@ruichips.com

X-ON Electronics

Largest Supplier of Electrical and Electronic Components

Click to view similar products for [MOSFET](#) category:

Click to view products by [Ruichips](#) manufacturer:

Other Similar products are found below :

[614233C](#) [648584F](#) [MCH3443-TL-E](#) [MCH6422-TL-E](#) [NTNS3A92PZT5G](#) [IRFD120](#) [IRFF430](#) [JANTX2N5237](#) [2N7000](#) [AOD464](#)
[2SK2267\(Q\)](#) [2SK2545\(Q,T\)](#) [405094E](#) [423220D](#) [MIC4420CM-TR](#) [VN1206L](#) [614234A](#) [715780A](#) [SSM6J414TU,LF\(T](#) [751625C](#)
[IPS70R2K0CEAKMA1](#) [BSF024N03LT3 G](#) [PSMN4R2-30MLD](#) [TK31J60W5,S1VQ\(O](#) [2SK2614\(TE16L1,Q\)](#) [DMN1017UCP3-7](#)
[EFC2J004NUZTDG](#) [FCAB21350L1](#) [P85W28HP2F-7071](#) [DMN1053UCP4-7](#) [NTE2384](#) [NTE2969](#) [NTE6400A](#) [DMC2700UDMQ-7](#)
[DMN2080UCB4-7](#) [DMN61D9UWQ-13](#) [US6M2GTR](#) [DMN31D5UDJ-7](#) [SSM6P54TU,LF](#) [DMP22D4UFO-7B](#) [IPS60R3K4CEAKMA1](#)
[DMN1006UCA6-7](#) [DMN16M9UCA6-7](#) [STF5N65M6](#) [IRF40H233XTMA1](#) [IPSA70R950CEAKMA1](#) [IPSA70R2K0CEAKMA1](#) [STU5N65M6](#)
[C3M0021120D](#) [DMN6022SSD-13](#)