



目 录

TABLE OF CONTENTS

| | |
|--|---------|
| 公司简介 Company Profile | P1 |
| 固体电解质铝电解电容器特性介绍 Introduction | P2~P3 |
| 产品一览表 Product List | P4 |
| 产品系统图 SERIES CHART | P5 |
| 料号说明 Explanation of parts numbers | P6 |
| 加工方式 Diagram of Lead Cutting And Forming or Taping | P7~P10 |
| 使用注意事项 Attention before using | P11~P18 |
| 固体电解质铝电解电容器失效模式及原因分析 Typical failure modes and factors of aluminum electrolytic capacitors | P19 |
| 生产流程图 Production Flow Chart | P20 |
| 引线式固体电解质铝电解电容器 Radial Type Conductive Polymer Aluminum Solid Electrolytic Capacitors | P21~46 |
| 贴片式固体电解质固态铝电解电容器 SMD Type Conductive Polymer Aluminum Solid Electrolytic Capacitors | P47~58 |
| 混合型铝电解电容器 Hybrid Conductive Polymer | P59~62 |



公 司 简 介

肇庆市瑞隆电子有限公司是一家专业生产固态铝电解电容器的创新型公司。企业的主导产品是全系列的固态铝电解电容器，月产能在1500万只以上。固态铝电解电容具备环保、低阻抗、高低温稳定、耐高纹波及高信赖度等优越特性，且导电性、频率特性及寿命均佳，适用于低电压、高电流的应用中。主要应用于各类照明电源、适配器、智能机器人、工业计算机、汽车电子等。

瑞隆电子集研发、生产、制造于一体，并成功研发出同行业内先进、高效的生产设备及工艺，且已得到业内的推广使用。并研发出最新型的高、中、低压SMD固态电容器，产品可靠性高、性能优异。

肇庆市瑞隆电子有限公司拥有雄厚的技术力量，先进的生产设备工艺，完善的检测手段，致力于成为固态铝电解电容器的全球最佳供应商之一。



■ 产品特性

● 固体电解质铝电解电容器具有的优势（下图中，CL为固态电容、AL为液态电电解电容）

● 在高频下具有极低阻抗（低ESR）

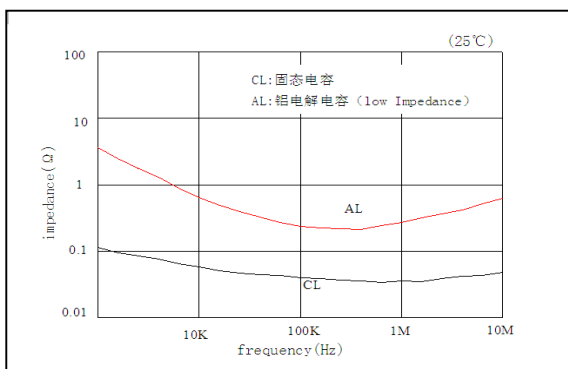

● 具有极小的温度特性偏差

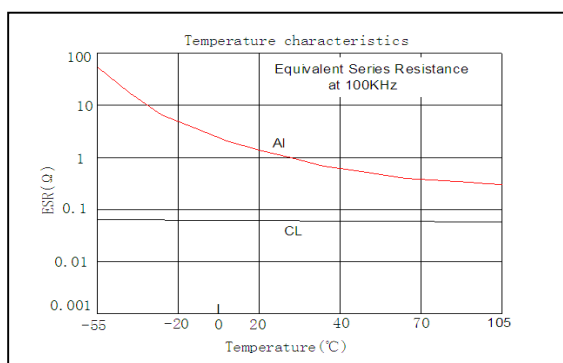

● 耐高纹波电流

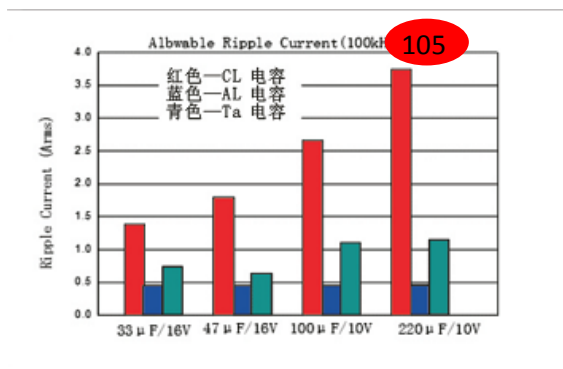

● 利于电路设计小型化。

● 安全性，避免爆浆可能

■ 应用电路

输入、输出平滑电路

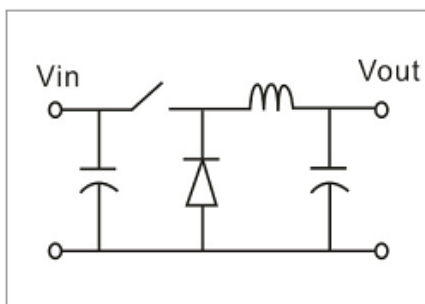

储能电路、旁路

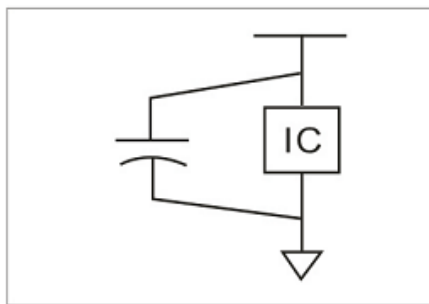

滤波电路

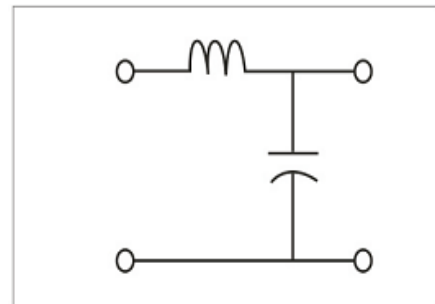

■ 应用设备

微型计算机

数码产品

工业计算器

薄型DVD

液晶电视

LED驱动

汽车导航

精密电源



■FEATURES

Advantages of Conductive Polymer Aluminum Solid Electrolytic Capacitor (in below diagram, CL=Solid Capacitor, AL=Aluminum Electrolytic capacitor)

●With ultra low impedance at high frequency (Low ESR)

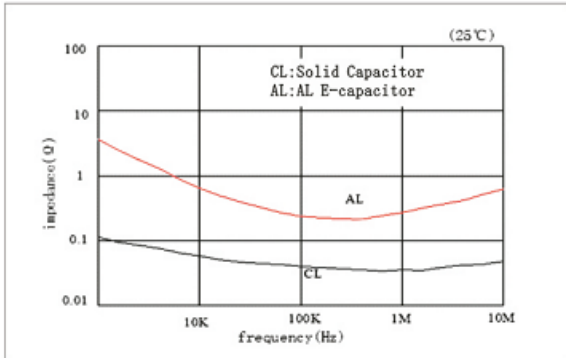

●Stable characteristics at different temperature

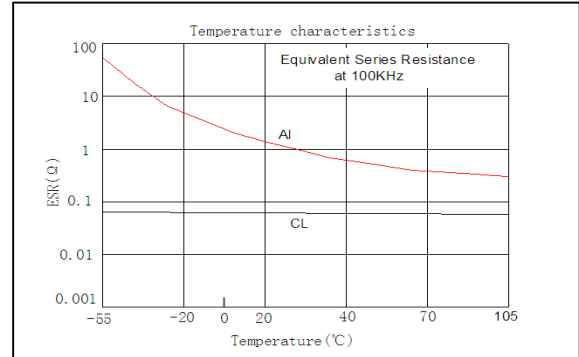

●High ripple current resistance

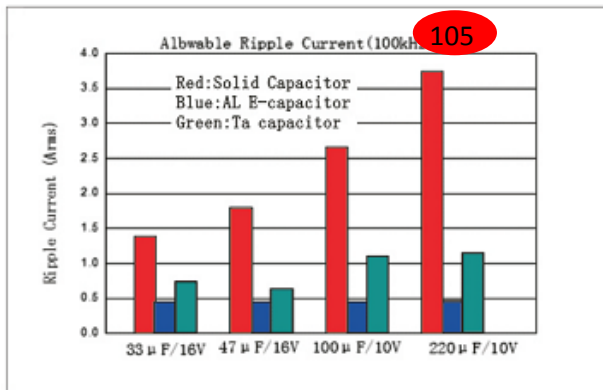

●Good for circuit miniaturization design

●Safty without explosion

■APPLICATIONS to CIRCUIT

Input & output of smoothing circuit

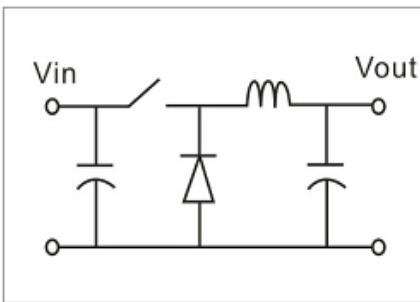

Storage & bypass circuit

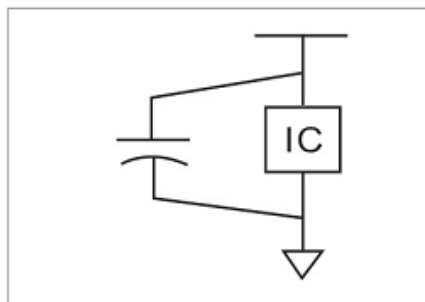

Filtering circuit

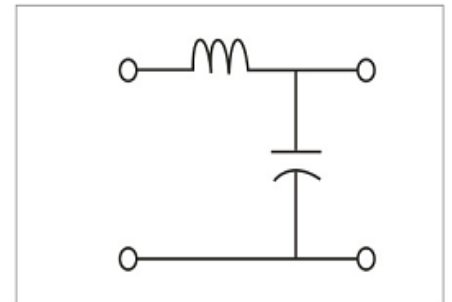

■APPLICATIONS

- | | |
|-------------------|------------------|
| Microcomputer | Digital Products |
| Industry Computer | Slim DVD |
| LCD/LED TV | LED Driver |
| Auto-navigation | Accurate power |



■LIST OF PRODUCTS

| Classification | Series | page | Features | Endurance | | | Rated voltage range (V) | Capacitance range(μF) |
|----------------|--------|-------|--|---------------|---------------|--------------|-------------------------|-----------------------|
| | | | | Low Tem. (°C) | High Tem.(°C) | Life (hours) | | |
| Radial type | E1 | 21~25 | Super low ESR, high ripple current | -55 | 105 | 2000 | 2.5~25 | 22~2200 |
| | E2 | 26~30 | Low ESR, high ripple current | -55 | 105 | 2000 | 2.5~25 | 22~2200 |
| | E4 | 31~33 | Low ESR, high ripple current, high temperature | -55 | 125 | 2000 | 2.5~25 | 22~2200 |
| | E5 | 34~38 | Low ESR, high ripple current, long life | -55 | 105 | 5000 | 2.5~25 | 22~2200 |
| | H2 | 39~41 | Low ESR, high ripple current, high voltage | -55 | 105 | 2000 | 35~100 | 10~470 |
| | H4 | 42~43 | Low ESR, high ripple current, high voltage, high temperature | -55 | 125 | 2000 | 35~100 | 10~330 |
| | H5 | 44~46 | Low ESR, high ripple current, high voltage, long life | -55 | 105 | 5000 | 35~100 | 10~330 |
| SMD type | M1 | 47~50 | Super low ESR, high ripple current | -55 | 105 | 2000 | 2.5~100 | 10~2200 |
| | M2 | 51~54 | Low ESR, high ripple current | -55 | 105 | 2000 | 2.5~100 | 10~2200 |
| | M5 | 55~58 | Low ESR, high ripple current, long life | -55 | 105 | 5000 | 2.5~100 | 10~2200 |
| Radial type | H6 | 59~60 | Low ESR, high ripple current, high voltage | -55 | 105 | 2000 | 10~50 | 10~1000 |
| SMD type | M6 | 61~62 | Low ESR, high ripple current, high voltage | -55 | 105 | 2000 | 10~50 | 10~1000 |

本书所记载的内容可能未经提示而变更，贵司在使用时按敝司的承认书的基准使用。



■产品系统图

■SERIES CHART

●固体电解质铝电解电容器(Conductive Polymer)

Radial type

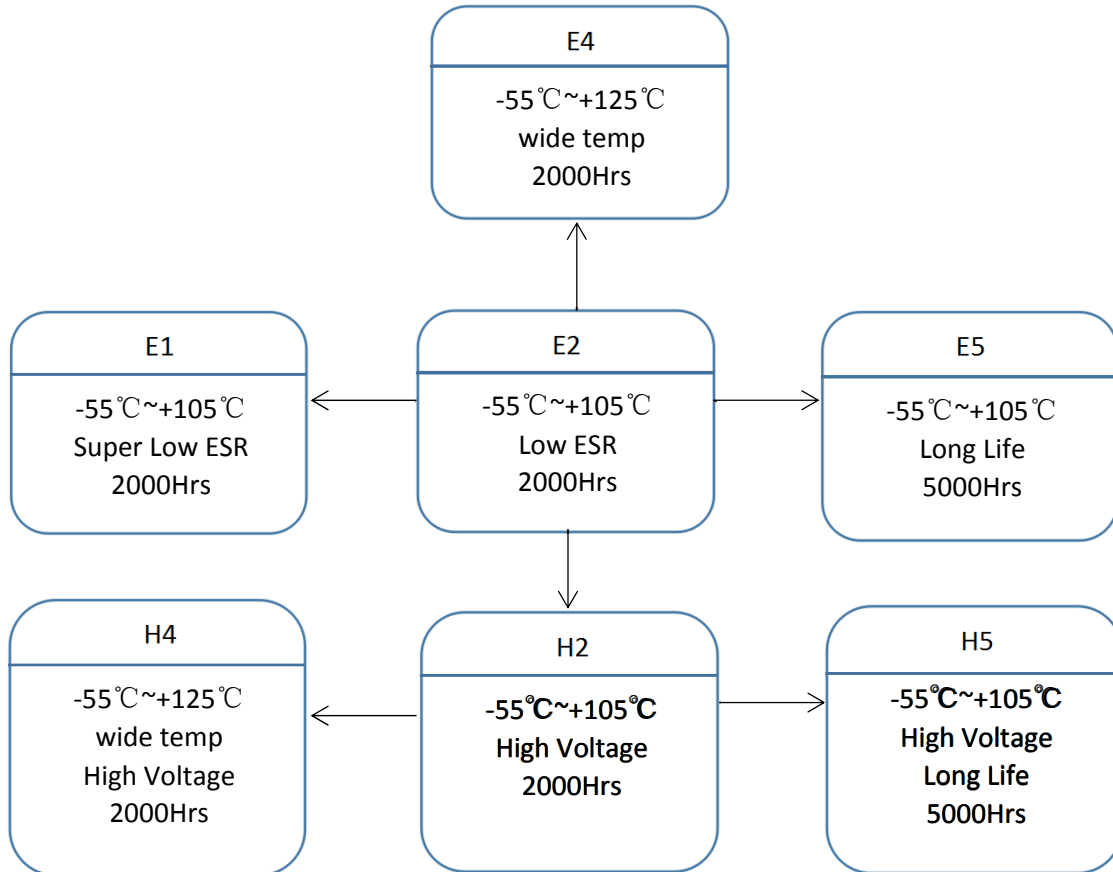

SMD type

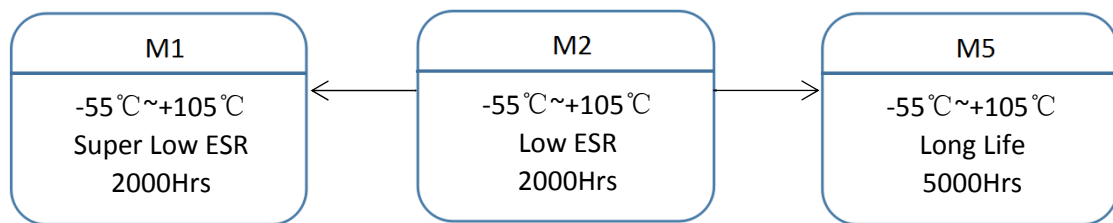

●混合型铝电解电容器(Hybrid Conductive Polymer)

Radial type

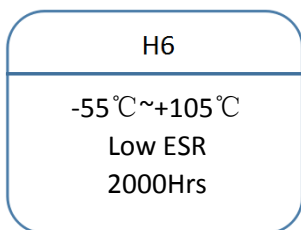

SMD type

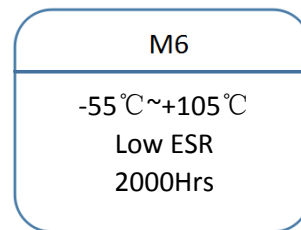



◆料号说明 Explanation of parts numbers

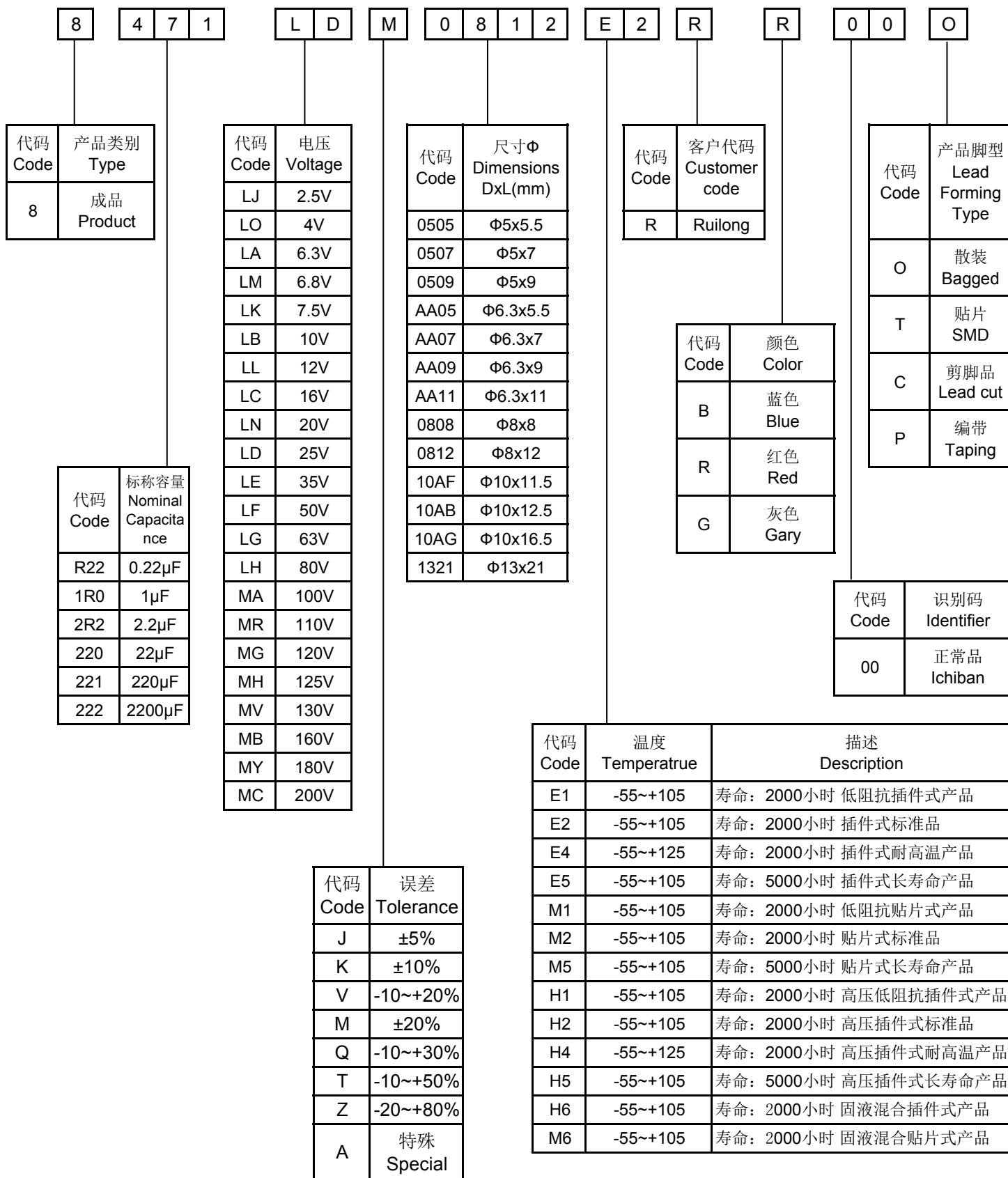



◆ 脚型加工图(尺寸单位mm)

1、LO=导针型长脚 (Long lead)

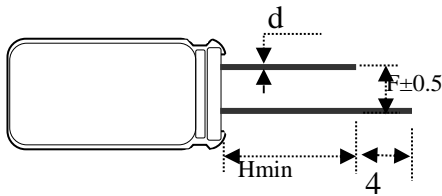

| | | | | | |
|----|-----|-----|-----|-----|-----|
| Φ数 | 4 | 5 | 6.3 | 8 | 10 |
| d | 0.5 | 0.5 | 0.6 | 0.6 | 0.6 |
| F | 1.5 | 2 | 2.5 | 3.5 | 5 |
| H | 15 | 15 | 15 | 15 | 15 |

2、LC=直脚切脚 (Lead cut)

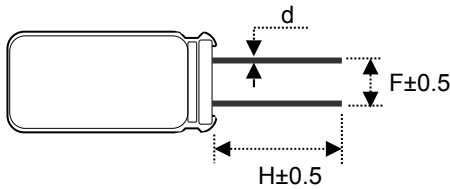

| | | | | | |
|----|-------|-----|-----|-----|-----|
| Φ数 | 4 | 5 | 6.3 | 8 | 10 |
| d | 0.5 | 0.5 | 0.6 | 0.6 | 0.6 |
| F | 1.5 | 2 | 2.5 | 3.5 | 5 |
| H | 依客户要求 | | | | |

4、PT=平盒编带品 (Radial type) Ammo Taping

[Fig. 1 (Diameter for Φ4 to Φ8)]

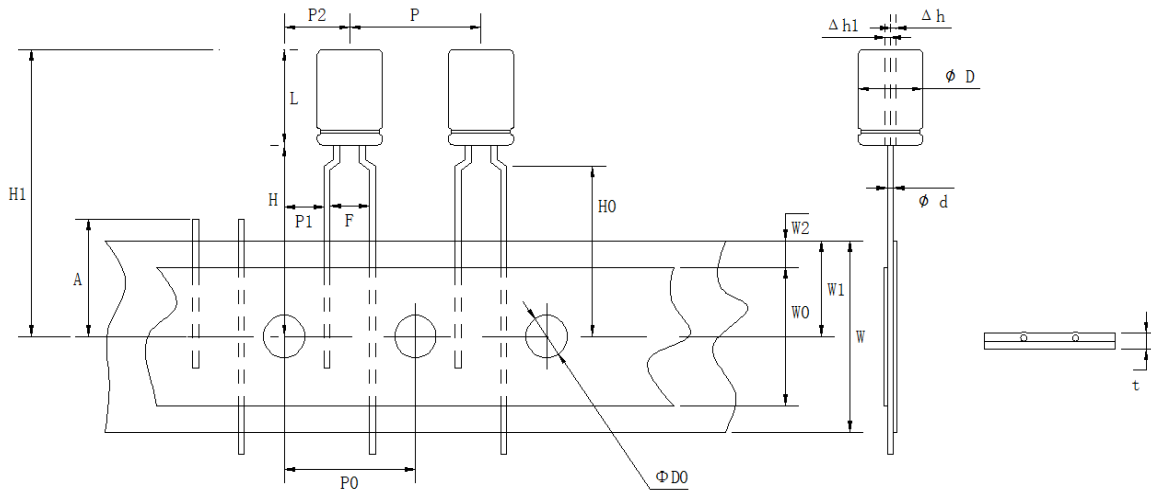

| D | L | d | P | P0 | P1 | P2 | F | W | W0 | W1 | W2 | H | H0 | D0 | A |
|------|------|-------|------|------|------|------|------|------|-----|------|-----|------|------|------|-----|
| ±0.5 | ±1.0 | ±0.02 | ±1.0 | ±0.2 | ±0.7 | ±1.0 | ±0.5 | ±0.5 | min | ±0.5 | max | ±0.5 | ±0.5 | ±0.2 | max |
| 5 | 8 | 0.5 | 12.7 | 12.7 | 3.85 | 6.35 | 5 | 18 | 13 | 9 | 1.5 | 18.5 | 16 | 4 | 11 |
| 6.3 | 8 | 0.6 | | | | | | | | | | 18.5 | | | |
| 6.3 | 12 | 0.6 | | | | | | | | | | 18.5 | | | |
| 8 | 8 | 0.6 | | | | | | | | | | 18.5 | | | |
| 8 | 12 | 0.6 | | | | | | | | | | 18.5 | | | |



[Fig. 2 (Diameter for $\Phi 4$ to $\Phi 5$)

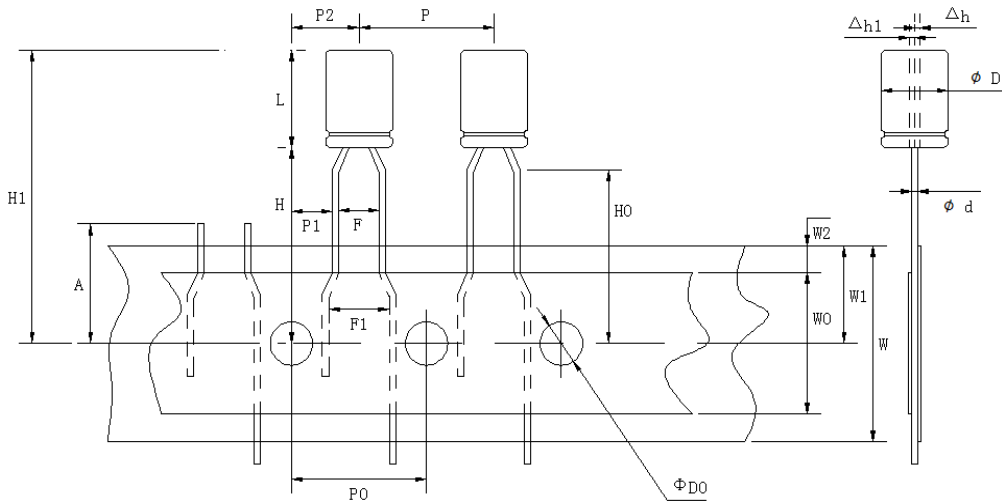

| D | L | d | P | P0 | P1 | P2 | F | W | W0 | W1 | W2 | H | H0 | D0 | A |
|------|------|-------|------|------|------|------|------|------|-----|------|-----|------|------|------|-----|
| ±0.5 | ±1.0 | ±0.02 | ±1.0 | ±0.2 | ±0.7 | ±1.0 | ±0.5 | ±0.5 | min | ±0.5 | max | ±0.5 | ±0.5 | ±0.2 | max |
| 5 | 8 | 0.5 | 12.7 | 12.7 | 5.1 | 6.35 | 2.5 | 18 | 13 | 9 | 1.5 | 18.5 | 16.5 | 4 | 11 |

[Fig. 3 (Diameter for $\Phi 6$ to $\Phi 8$)

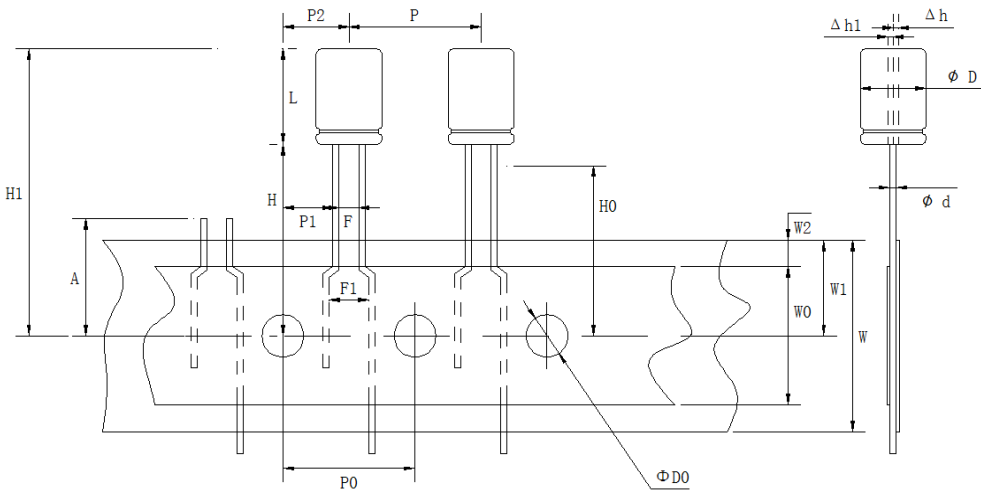

| D | L | d | P | P0 | P1 | P2 | F | W | W0 | W1 | W2 | H | D0 | A |
|------|------|-------|------|------|------|------|------|------|-----|------|-----|------|------|-----|
| ±0.5 | ±1.0 | ±0.02 | ±1.0 | ±0.2 | ±0.7 | ±1.0 | ±0.5 | ±0.5 | min | ±0.5 | max | ±0.5 | ±0.2 | max |
| 6.3 | 8.0 | 0.6 | 12.7 | 12.7 | 5.4 | 6.35 | 2.5 | 18 | 13 | 9 | 1.5 | 18.5 | 4 | 11 |
| 6.3 | 12.0 | 0.6 | | | | | 2.5 | | | | | 18.5 | | |
| 8 | 8.0 | 0.6 | | | | | 3.5 | | | | | 18.5 | | |
| 8 | 12.0 | 0.5 | | | | | 3.5 | | | | | 20 | | |



[Fig. 4 (Diameter for $\Phi 10$)]

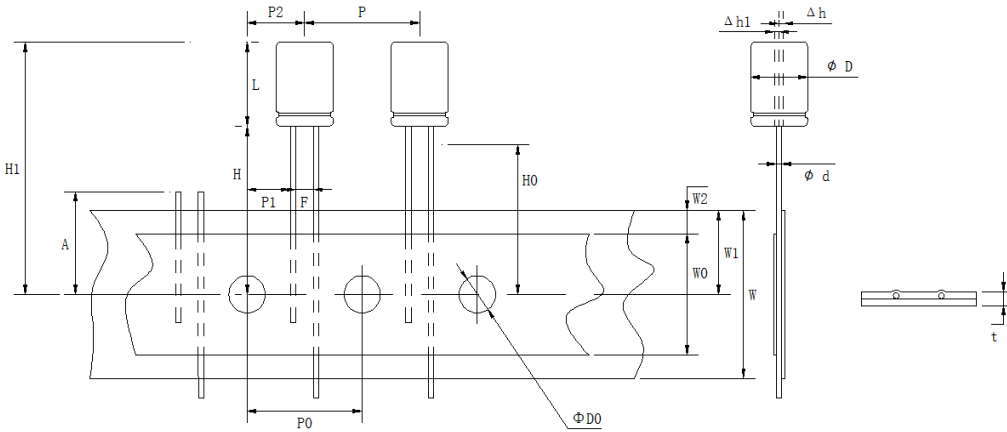

| D | L | d | P | P0 | P1 | P2 | F | W | W0 | W1 | W2 | H | D0 | A |
|------|------|-------|------|------|------|------|------|------|------|------|-----|------|------|-----|
| ±0.5 | ±1.0 | ±0.02 | ±1.0 | ±0.2 | ±0.7 | ±1.0 | ±0.5 | ±0.5 | min | ±0.5 | max | ±0.5 | ±0.2 | max |
| 10 | 12.0 | 0.6 | 12.7 | 12.7 | 3.85 | 6.35 | 5 | 18 | 12.5 | 9 | 1.5 | 20 | 4 | 11 |

● Packing Information

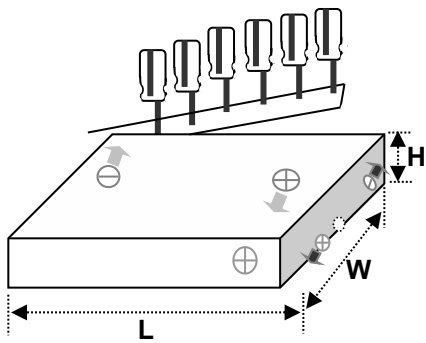

| L | W | H | Case size $\Phi D \times L$ (mm) | Q'TY(pcs) |
|-----|-----|----|----------------------------------|-----------|
| 340 | 250 | 50 | 4 | 2000 |
| 340 | 250 | 50 | 5、6.3 | 2000 |
| 340 | 250 | 50 | 8 | 1000 |
| 340 | 250 | 50 | 10 | 500 |



5、SMD Type 表面封装电容结构

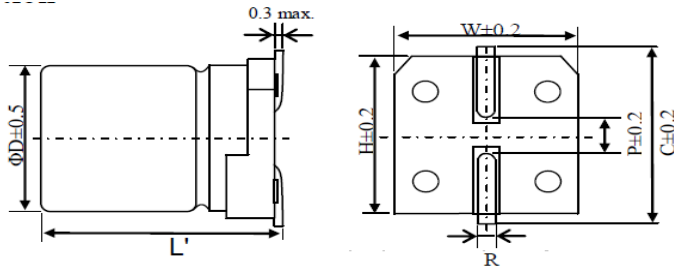

| ΦD | W | H | C | R | P |
|-----|------|------|------|---------|-----|
| 5 | 5.3 | 5.3 | 5.9 | 0.5~0.8 | 1.4 |
| 6.3 | 6.5 | 6.5 | 7.2 | 0.5~0.8 | 2.2 |
| 8 | 8.3 | 8.3 | 9.0 | 0.7~1.1 | 3.1 |
| 10 | 10.3 | 10.3 | 11.0 | 0.7~1.1 | 4.5 |

●SMD TAPING (mm)

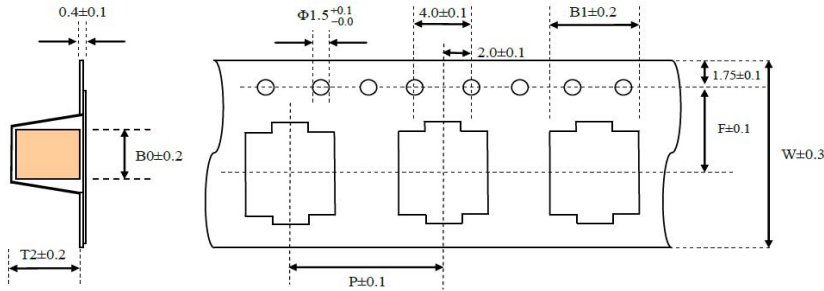

Figure 9

| Size | 5*3.8~4.5 | 5*5.7 | 6.3*3.8~4.5 | 6.3*5.7 | 8*6.9 | 8*9.7 | 10*12.6 |
|------|-----------|-------|-------------|---------|-------|-------|---------|
| W | 12 | 12.0 | 16.0 | 16 | 24 | 24 | 24 |
| P | 12 | 12.0 | 12.0 | 12 | 12 | 16 | 16 |
| F | 5.5 | 5.5 | 7.5 | 7.5 | 11.5 | 11.5 | 11.5 |
| B1 | 6.5 | 6.5 | 8.6 | 8.6 | 8.6 | 8.6 | 10.7 |
| B0 | 5.7 | 5.7 | 6.9 | 6.9 | 8.6 | 8.6 | 10.7 |
| T2 | 4.7 | 6.2 | 4.7 | 6.2 | 7.2 | 10.3 | 13 |

●Packing of SMD product

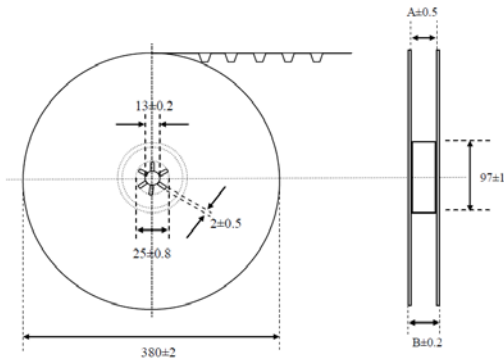

Figure 10

| Size | 5*3.8~5.7 | 6.3*3.8~5.7 | 8*6.9 | 8*9.7 | 10*12.6 |
|------|-----------|-------------|-------|-------|---------|
| A | 13.5 | 17.5 | 25.3 | 25.3 | 25.3 |
| B | 17.5 | 21.9 | 30 | 30 | 30 |

Packaging quantity

| Size | pcs/reel | pcs/box |
|---------------------|----------|---------|
| 5.0Φ,6.3Φ*3.8L~4.5L | 1500 | 15000 |
| 5.0Φ,6.3Φ*5.7L | 1200 | 12000 |
| 6.3Φ*7.7L | 1000 | 10000 |
| 6.3Φ*9.0L | 900 | 9000 |
| 8.0Φ*6.9L | 1000 | 6000 |

| Size | pcs/reel | pcs/box |
|------------|----------|---------|
| 8.0Φ*9.8L | 500 | 3000 |
| 8.0Φ*12.6L | 400 | 2400 |
| 10.0Φ*12.6 | 400 | 2400 |



■使用注意事项（固体电解质铝电解电容器）

一、设计方面的确认事项

1、禁止使用电路

固体电解质铝电解电容器（以下简称电容器）有可能因焊接时的热应力使其漏电流发生变化。请避免在对漏电流敏感电路中使用。

- ①高电阻电压保持电路
- ②耦合电路
- ③时间常数电路

2、电路设计

请在确认以下内容的基础上进行电路设计。

- ①随着温度及频率的变化，电容器的电气特性会随之变化。请在确认这些变化之后进行电路的设计。
- ②当并联2个以上的电容器时，请在设计电路时考虑电流的平衡。
- ③当串联2个以上的电容器时，因加载电压存在差异，有可能加载过电压，请使用的时候另行咨询我们。
- ④请勿在电容器的周围以及印刷配线板的背面安装发热部件。

3、极性

固体电解质铝电解电容器是具有极性的电容器。请不要加载反向电压或交流电压。如果安装时极性弄反，有可能导致电路在初始状态短路。

4、加载电压

请不要加载超过额定电压的电压，因为即使电容器只是一瞬间承受超过额定电压的电压，也会导致漏电流增加和发生短路故障。请将和直流电压迭加的纹波电压峰值设定在额定电压以下。

5、纹波电流

请不要叠加超大电流（超过额定纹波电流的电流）。当过大的纹波电流叠加时，可能导致内部的发热量增大，寿命缩短，发生短路故障等。

6、使用温度

如果在超出工作温度范围的环境下使用，会导致性能老化及发生故障，请在工作温度范围内使用。

7、充放电

请不要在反复急速充放电的电路中使用。如果用在反复急速充放电的电路中，可能导致静电容量减少及电容器因内部发热损坏等。当高峰电流值超过了20A时，为了保持信赖性，建议使用保护电路。

8、漏电流

有时候漏电流会上升，但如果在工作温度内加载电压，则会通过利用自我修复作用逐渐减少。此外，此时的漏电流减少的速度，越接近工作上限温度及额定电压就越快。

漏电流上升的原因如下：

- ①焊接
- ②高温无负载、高温高湿、温度急剧变化等试验

9、故障及寿命

（1）故障模式

- ①产品温度上升引起的静电容量减少及ESR的上升引起的开放模式磨损是主要的故障模式。
- ②由于加载超过额定电压的电压引起短路和通电电流过大的时候，会因内压的上升而使得
 - 通过降低周围温度、纹波电流、加载电压可以减少故障率。
 - 设置保护电路、保护装置，确保设备安全。



◆ Attention before using

One、 Confirm before design

1、 Can not be used in below circuits

Conductive polymer aluminum solid electrolytic capacitors (Hereinafter called capacitor) is possible to lead its leakage current to be changed by the thermal stress while soldering. Therefore, please do not use capacitor in a circuit with sensitive leakage current.

- ① Do not use capacitor in a high resistance and high voltage keeping circuit.
- ② Do not use capacitor in a coupling circuit.
- ③ Do not use capacitor in a time constant circuit.

2、 Circuit design

Please confirm below contents before design a circuit.

- ① Before design a circuit, please note that characteristics of capacitor will be changed along with the change of temperature and frequency.
- ② Please consider the current balance when 2 or more capacitors have to be paralleled in a circuit.
- ③ Please connect us while 2 or more capacitors are series in circuit as it's possible that overvoltage would be applied
- ④ Please do not assemble heat generation components around the capacitor or at the back side of PCB.

3、 Polarity

Conductive Polymer Aluminum Solid Electrolytic Capacitor is with polarity. Please do not apply a reverse voltage or current.

Short-circuit will happen to the capacitor if assemble in a reverse polarity.

4、 Load a voltage

Please do not load an over rated voltage as even just for a while, it will cause leakage current increasing and failure of short-circuit.

Please set a peak value of ripple voltage which added DC voltage under the rated voltage.

5、 Ripple current

Please do not load an overcurrent (a current over rated ripple current). While an over ripple current is applied, which will make heat amount inside of capacitor larger, life shorter, short-circuit happened, etc.

6、 Working temperture

Function aging and failure does happen if use capacitor in an ambient temperature over rated working temperature.

Please use capacitor in the range of working temperature.

7、 Charge and discharge

Please do not use capacitor in a repeated rapid charging and discharging circuit. If use it in a repeated rapid charging and discharging circuit

it will cause capacitance reduction or inside failure by heat generation. If peak current is over 20A, Protection Circuit application is suggested in order to keep its reliability.

8、 Leakage current

Leakage current will increase sometimes, but which will decrease due to restoring itself with application of voltage at the working temperature.

Besides, reduction speed of leakage current will be faster and faster while closer to upper limited temperature and rated voltage.

The reason why leakage current increase is below:

- ① Soldering
- ② High temperature without load、 High humidity and temperature、 Temperature change shirply and test ect.

9、 Failure and Life

(1) Failure Mode

- ① Capacitance reduction by temperature increasing and open model failure by ESR increasing are the major failure mode.
- ② While an over rated voltage or overcurrent is applied, that lead inner pressure increasing. It need
 - to cut down its failure rate by reduce the ambient temperature, ripple current or loading voltage.
 - to assure safety of equipment by setting protective circuit or device.



(2) 寿命推算

$$L_x = L_0 \times 2^{\frac{T_0 - T_x}{2}} \times 2^{\frac{-\Delta T}{10}}$$

L_x : 在实际使用条件中推算的寿命(小时)

L_0 : 工作在额定工作电压和最高工作温度下的寿命(小时)

T_0 : 电容最高工作温度(°C)

T_x : 实际使用时的周围温度(°C)

ΔT : 叠加纹波电流时的自我温升(°C)

叠加纹波电流时大致的自我温升 ΔT 可以用以下公式算出:

$$\Delta T' = \Delta T_0 \times \left(\frac{I_x}{I_0}\right)^2$$

ΔT_0 : 电容器叠加额定纹波电流时的自我温升20°C

I_x : 电容器在实际使用时的纹波电流(Arms)

I_0 : 电容器在工作上限温度时的额定纹波电流(Arms)

如需得到更加准确的 ΔT , 推荐使用热电偶进行实测。

10、电容器的绝缘

电容器的外壳和阴极端子及阳极端子和电路型板之间请进行电气绝缘。

11、电容器的使用环境

电容器请不要在以下环境中使用。

- ①直接溅水, 盐水及油, 或者结露状态的环境
- ②阳光直接照射的环境
- ③充满有害气体(硫化氢、亚硫酸、亚硝酸、氯及其化合物、溴及其化合物、氨等)环境
- ④臭氧、紫外线及放射线照射的环境
- ⑤振动或冲击条件超过产品目录或规格说明规定范围的过激环境

12、电容器的配置

- ①请将电容器的端子间隔和印刷配线板的孔间隔对准。
- ②请不要在电容器的封口部下面进行电路配线。如果电容器附件配线, 请确保线路间隔在 1mm(可以的话2mm)以上。
- ③两面印刷配线板上安装电容器时, 设计时应注意电容器下方不可有多余的基板孔或表里连接用贯通孔。
- ④两面印刷配线板上装配电容器时, 电容器主体的安装部位不可有配线线路。

二、安装

1、组装时

- ①已经成套组装并通过电的电容器请勿再次使用。
- ②电容器内可能产生再生电压。此时, 请通过1K Ω 左右的电阻进行放电。
- ③在超过常温35°C、湿度75%RH的条件下, 超过产品目录或规格说明书的规定期限进行长期保管时, 电容器的漏电流有可能增大。此时, 请通过1K Ω 左右的电阻放电后使用。
- ④安装前请确认电容器的规格(静电容量及额定电压)
- ⑤安装前请确认电容器的极性。
- ⑥请勿使用跌落到地板等上的电容器。
- ⑦安装时请勿使电容器变形。
- ⑧请确认电容器的端子间隔和印刷配线板孔间隔是否对准后, 再进行安装。
- ⑨请不要在电容器上施加过大机械强度的力。

如果在电容器上施加过强的力, 电极端子会折断或变形, 从而影响到安装。此外, 还有可能导致短路、断线、漏电流增大和外包装破损等。自动装配机在对准吸附安装位置以及切断引线时也有坑内产生应力, 请注意它的冲击力。

2、焊接时的焊接耐热

(1) 电烙铁焊接

焊接时, 其焊接时间和焊接温度不应超过10秒钟及260摄氏度。注意不要将焊锡附在端子以外的电容器表面上; 电烙铁等高温发热装置应与电解电容器塑料外壳保持适当的距离, 以防止过热造成塑料破裂。



(2) Lifetime Estimation

$$L_x = L_o \times 2^{\frac{T_o - T_x}{2}} \times 2^{\frac{-\Delta T}{10}}$$

L_x : Estimation of actual lifetime (h)

L_o : Specified lifetime with the rated voltage at the upper limit of the category temperature (h).

T_o : Maximum category temperature (°C)

T_x : Actual ambient temperature of the capacitor (°C)

ΔT : Rise of internal temperature due to the rated ripple current (°C)

An approximate value of ripple current-caused ΔT can be calculated using Equation

$$\Delta T = \Delta T_o \times \left(\frac{I_x}{I_o}\right)^2$$

ΔT_o : Rise in internal temperature due to the rated ripple current (20°C)

I_x : Operating ripple current (Arms) actually flowing in the capacitor

I_o : Rated ripple current (Arms), frequency compensated, at the upper limit of the category temperature range

To determine more accurate values of ΔT , they can be actually measured using a thermocouple.

10、Insulation to Capacitor

Electrical insulation should be made between case and negative terminal, positive terminal and PCB.

11、Using environment of capacitor

Do not use capacitor in below environment

- ① Under the environment of splash water directly, salt water and oil .
- ② an environment will be exposed to direct sunlight
- ③ an environment with hazardous gas or fumes (such as H₂S、 H₂SO₃、 HNO₂、 Cl & chloride、 Br & bromide、 NH₃、 etc)
- ④ an environment with O₃ ,ultraviolet ray and radiation exposure
- ⑤ an environment with serious shake or shock condition over specified range in catalogue.

12、Circuit route design concerning capacitor on PCB

- ① Distance between terminals of capacitor must fit distance between holes on PCB.
- ② Please do not design a circuit route through the capacitor covering area on PCB. If it is necessary, please keep space to be 1mm (2mm if possible) or more.
- ③ If capacitor will be assembled onto a double-layer PCB, please note that hole should not be in the capacitor covering area on the PCB. Connection should be with Through Hole.
- ④ If capacitor will be assembled onto a double-layer PCB, circuit route can not go through the capacitor cover area on PCB.

Two、Assembly

1、Assembly

- ① Please do not use a capacitor which had been ever assembled and charged before.
- ② Inside capacitor may regenerate electricity. Please discharge it with a 1KΩ resistor.
- ③ Storage in a environment over 35°C and 75%RH for a long time over the term specified in catalogue or datasheet, static electricity maybe generate inside capacitor. Please use it after discharged with a 1KΩ resistor.
- ④ Please confirm the specification of capacitor (capacitance and rated voltage) before assembly.
- ⑤ Please confirm the polarity of capacitor before assembly.
- ⑥ Please do not use a capacitor which ever dropped on the floor.
- ⑦ Please do not deform capacitor during assembly.
- ⑧ Please confirm distance between terminals of capacitor if fit the distance between holes on PCB before assembly.
- ⑨ Please do not apply an over physical stress during assembly.
If not, over physical stress will make terminals to be broken or deformed as well as make capacitor to be short-circuit, connection broken, leakage current increasing, sleeving damaged,etc.
Please be careful the assembling stress during assembling in auto-assembly machine.

2、Soldering heat resistance

(1) Soldering with iron probe

During soldering, time and temperature can not exceed 10 seconds and 260°C, as well as soldering tin can not adhere onto any part of capacitor surface except terminals. Heat generating devices such as Soldering Iron are kept away from plastic sleeving of capacitor. If not, over heat will crack it.



(2) 正流焊接（不适用SMD品）

请在以下正流焊流的条件范围内

| 步骤 | 温度 | 时间 | 次数 |
|----|--------|--------|-------|
| 预热 | 120℃以下 | 120秒以下 | 1次 |
| 焊接 | 260±5℃ | 10秒以下 | 1次或2次 |

(3) 回流焊（仅限于SMD品）

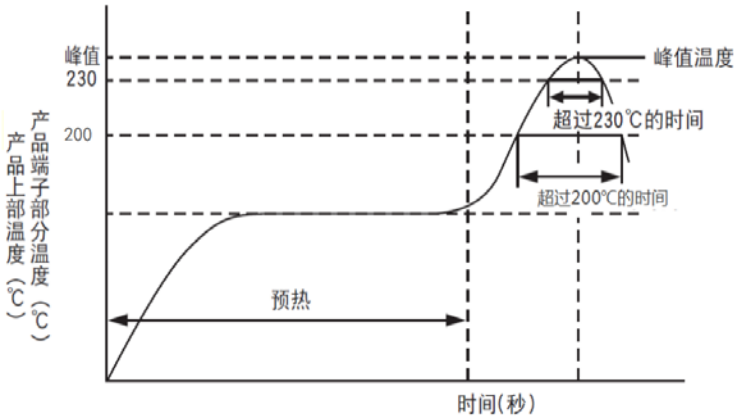

| 额定电压 (Vdc) | 预热 | 超过200℃的时间 | 超过230℃的时间 | 峰值温度 | 回流次数 |
|------------|-------------------|-----------|-----------|------|------|
| 2.5~10V | 150~180℃ ≦120秒 | ≦90秒 | ≦50秒 | 260℃ | 1次时 |
| | | | | 250℃ | 2次时 |
| 12~25V | | ≦90秒 | ≦50秒 | 240℃ | 1次时 |
| | | ≦80秒 | ≦40秒 | 240℃ | 2次时 |

注：第二次回流焊之前，必须让电容器温度冷却到室温。

3、焊接后的处理

应不产生以下的机械应力：包括使电容器发生倾倒、扭转；使电容器碰到线路板或其它组件

4、焊接后清洗：

| 清洗剂 | 清洗方法 |
|---|---|
| Pine Alpha ST-100S Clean Through 750H IPA(异丙醇) Aqua Cleaner 210SEP | 使用浸渍、超声波等方法，清洗剂为60℃以下，清洗时间不超过5分钟，清洗后，请将安装电容器的电路板以热风干燥10分钟以上（热风温度控制电容器的上限类别温度以下） |

- (1) 请不要使用含卤溶剂、强碱类、石油类溶剂以及含有二甲苯、丙酮溶剂的清洗剂
- (2) 为保护地球环境，请充分做好清洗剂污染管理(电导率、PH值、比重、水分含水率等)
- (3) 根据不同的清洗方法，有时会造成产品标识模糊等后果

5、使用固定剂、涂层剂时，请确认以下内容：

- (1) 不使用含卤素的固定剂、树脂涂层剂。
- (2) 在使用固定剂、涂层剂前，请将电路板与电容器之间清扫干净，不能残留焊接残渣及污垢；
- (3) 固定剂，涂层剂吸附前，确保无清洗液残留，并进行干燥处理。
- (4) 固定剂，涂层剂吸附前，请勿将电容器封口部分的整个面堵塞。

6、熏蒸处理

在电子设备类进出口时，有时需用溴化甲烷等卤素化合物进行熏蒸处理。此时，如果铝电解电容器接触到溴化甲烷等卤素化合物，会和【基板清洗】一样，有产生卤素离子而产生腐蚀反应的危险。本公司在进出口的时候，采用的是无需熏蒸处理的包装方式。客户在进出口电子设备，本成品及铝电解电容器单体的时候，请注意有无熏蒸处理，最终的包装形态等。（即使用瓦楞纸箱、塑料等进行包装，熏蒸其他还是有侵入内部的危险。）

三、保养检查注意事项

- 1、请定期检查使用于工业设备上的电容器。对电容器进行保养检查的时候，请先切断设备的电源，放掉电容器内的存储电。当用万用表检查时，请先确认万能表的极性后再使用。
- 2、请按以下内容进行定期检查。
 - ①外观有无明显异常
 - ②电气性能（静电容量、损失角正切值、漏电流）及产品目录书
 当以上内容有异常时，请确认电容器的规格，并进行替换等恰当的处理。



(2) Flow soldering (not suitable for SMD parts)

Please follow below flow soldering conditions

| Step | Temperature | time | times |
|---------|-------------|-----------|--------|
| Preheat | under 120°C | < 120 sec | 1 |
| Solder | 260±5°C | < 10 sec | 1 or 2 |

(3) Reflow soldering (for SMD parts only)

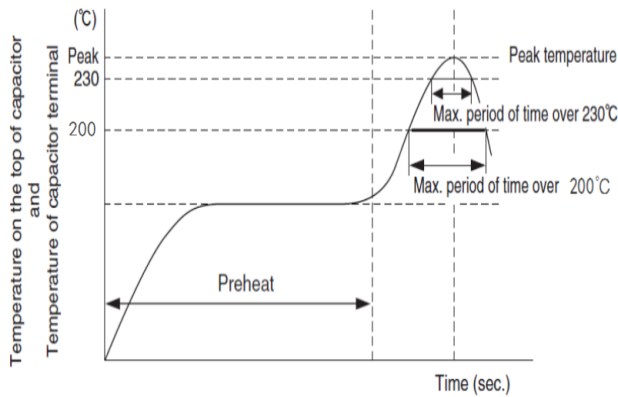

| Voltage range(Vdc) | Preheat | Time maintained above 200°C | Time maintained above 230°C | Peak temp. | Reflow number |
|--------------------|---------------|-----------------------------|-----------------------------|--------------|------------------|
| 2.5 to 10V | 150 to 180°C | 90 sec. max. | 50 sec. max. | 260°C max. | 1-cycle only |
| | | | | 250°C max. | 2-cycles allowed |
| 12 to 25V | 120 sec. max. | 90 sec. max. | 50 sec. max. | 240°C max. | 1-cycle only |
| | | | | 80 sec. max. | 40 sec. max. |

Note: The second reflow soldering shall be applied after the temperature of capacitors decreases down to the room temperature.

3、 After soldering

Can not withstand a physical stress that: make capacitor fall down, turn around or make it touch PCB or other components on PCB.

4、 PDB cleaning after soldering:

| cleaning agent | method of cleaning |
|---------------------|---|
| Pine Alpha ST-100S | Clean by immersion and ultrasonic, as well as the temperature of the cleaning agent shall be lower than 60°C。 Cleaning time should be within 5 minutes. After cleaning, PCB with capacitors should be dried with hot air for 10 minutes. (Temperature of hot air should be under the specified max temperature of the capacitor.) |
| Clean Through 750H | |
| IPA | |
| Aqua Cleaner 210SEP | |

- (1) Cleaning agent for capacitors should not contain any Alkali solvent, petroleum, base solvents, xylene, acetone.
- (2) In order to protect the environment, the solvents should be serious management (such as conductivity, PH, special gravity and water contents).
- (3) According to the different way of cleaning, maybe cause a blur of the marking.

5、 Please confirm using adhesives and coating materials as follow:

- (1) Do not use halogenated adhesives and coating materials to fix capacitors.
- (2) Flux between the surface of the PCB and sealing of Capacitors should be clean before using adhesives and coating materials.
- (3) Please clean remains of agent and dry PCB before using adhesives and coating materials.
- (4) Do not cover up all of the sealing area of the capacitors before using adhesives or coating materials.

6、 Fumigation

While import or export electronic equipments, sometimes it need to do fumigation with halide such as Methyl Bromide. If capacitor is touched by halide such as Methyl Bromide during which. That maybe lead corrosive reaction caused by halide ion just like 【PCB cleaning】

Our capacitors are packed without fumigation during import and export. Customers: please pay attention to the fumigation, final packing while import and export electronic equipments.

(During fumigation, there is risk that halide ion will go inside even packed with paper carton, plastic, etc.)

Three、 Maintenance and checking

- 1、 Please regularly check capacitors inside industrial equipment. Before doing maintenance and checking to capacitors, please turn off the power and discharge capacitors. Please confirm polarity of multimeter while checking capacitor with it.
- 2、 Please check capacitor based on below:
 - ① Obvious abnormal appearance or not.
 - ② Electrical characteristics (Capacitance、 Dissipation Factor、 Leakage current)and product catalogue.
 If abnormal was found, please replace it by a new one with the same specification.



四、紧急情况

- 1、设备使用时，当电容器产生了气体，短路引起了燃烧，或者产生恶臭和发出烟雾时，请切断设备的主电源，或者从插座上拔了电源线的插头。
- 2、当电容器异常或者燃烧时，有可能外包装树脂等燃烧和分解产生气体。因此，请不要将脸和手靠近。当喷出的气体进入眼睛，或吸入的时候，请马上用水洗眼、漱口。当粘附在皮肤上时，请用肥皂冲洗。

五、保管

请按照以下保管条件保管电容器。

- 1、不可将电容器保管在高温、高湿环境下。请保管在室温5~35℃、湿度75%以下的环境。

保管期限请参照下表。

| Items | 拆包前 | 拆包后 |
|-----------|--------|-----------|
| SMD品（贴片型） | 制作后2年内 | 自拆封日起1个月内 |
| 引线型 | 制作后2年内 | —— |

- 2、请不要将电容器保管在溅水、盐水及油的环境下。
- 3、请不要将电容器保管在充满有害气体（硫化氢、亚硫酸、压硝酸、氯及其化合物、溴及其化合物、溴化甲烷等卤素化合物、氨等）环境下。
- 4、请不要将电容器保管在臭氧、紫外线及放射线照射的环境下。
- 5、请尽可能包装好保管。

六、废弃处理

请交给专业的工业废弃物处理厂进行处理。

七、有害物质限用指令（RoHS）

我司产品符合欧盟对有害物质限用之规定。

| | |
|--------------|----------|
| 铅（Pb） | ≤1000ppm |
| 汞（Hg） | ≤1000ppm |
| 镉（Cd） | ≤100ppm |
| 铬（Cr） | ≤1000ppm |
| 多溴化联苯（PBBs） | ≤1000ppm |
| 多溴联苯醚（PBDEs） | ≤1000ppm |

无卤声明

我司产品符合下列卤素含量限制

| | |
|-------------|---------|
| 溴（Br） | 900ppm |
| 氯（CL） | 900ppm |
| 溴（Br）+氯（CL） | 1500ppm |



Four、Emergency

- 1、 If capacitor generated gas, smell, smoke or got burning from short-circuit, please turn off the main power source or pull out the plug from the electric outlet.
- 2、 Do not bring your face or hands near the emitting gas from capacitor when sealing rosin of an abnormal capacitor was burning or decomposing. If the gas gets into your eyes or you breathe the gas, please flush your eyes or rinse your mouth and throat with clean water immediately.
If the gas splash onto your skin, please wash it away with soap and water immediately.

Five、Storage

Please store capacitors according to below conditions:

- 1、 Indoor storage at a place with ambient temperature of 5°C to 35°C, and relative humidity lower than 75%.

Storage terms:

| Item | Before unpack | After unpack |
|-------------|---------------------------------|------------------------------|
| SMD Type | Within 2 years after production | within 1 months since unpack |
| Radial type | Within 2 years after production | — |

- 2、 Pls don't keep it under the environment of jawp ,salt water and oil.
- 3、 Please do not store capacitor in an environment with hazardous gas or fumes (such as H₂S、 H₂SO₃、 HNO₂、 Cl & chloride、 Br & bromide、 NH₃、 etc)
- 4、 Please do not store capacitor in an environment with O₃ ,ultraviolet ray and radiation exposure
- 5、 Please keep its package as good as possible.

Six、Scrap

Send them to the industrial waste processing plant.

Sseven、Restriction of Hazardous Substance Direcive (RoHS)

Our products are RoHS compliant.

| | |
|---------|----------|
| (Pb) | ≤1000ppm |
| (Hg) | ≤1000ppm |
| (Cd) | ≤100ppm |
| (Cr) | ≤1000ppm |
| (PBBs) | ≤1000ppm |
| (PBDEs) | ≤1000ppm |

Halogen-free Statement

Our products are below halogen content limit compliant.

| | |
|-------------|---------|
| (Br) | 900ppm |
| (CL) | 900ppm |
| (Br) + (CL) | 1500ppm |



◆ 固体电解质铝电解电容器失效模式及原因分析.

◆ Typical failure modes and factors of aluminum electrolytic capacitors.

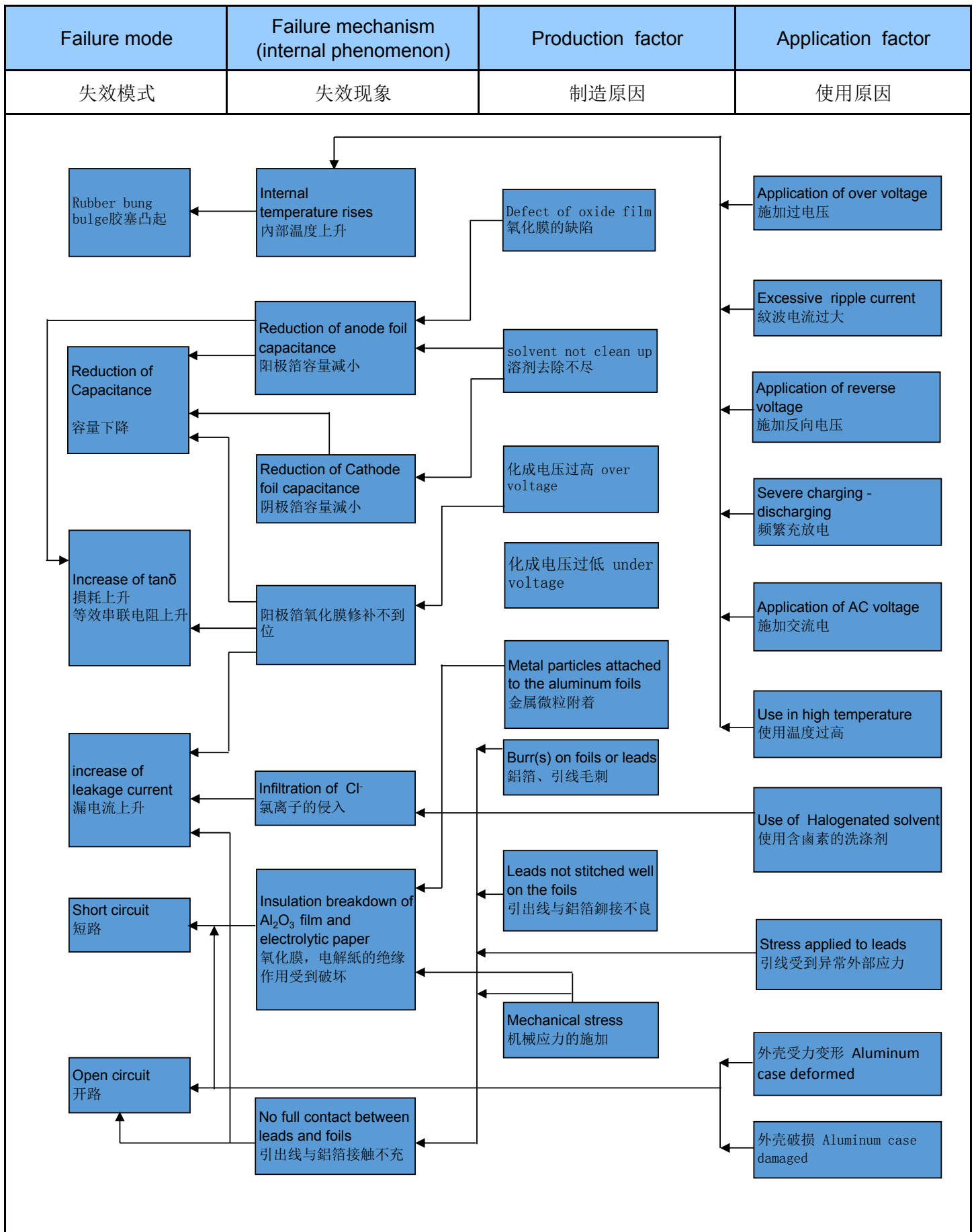



◆ 生产流程图

◆ Production Flow Chart

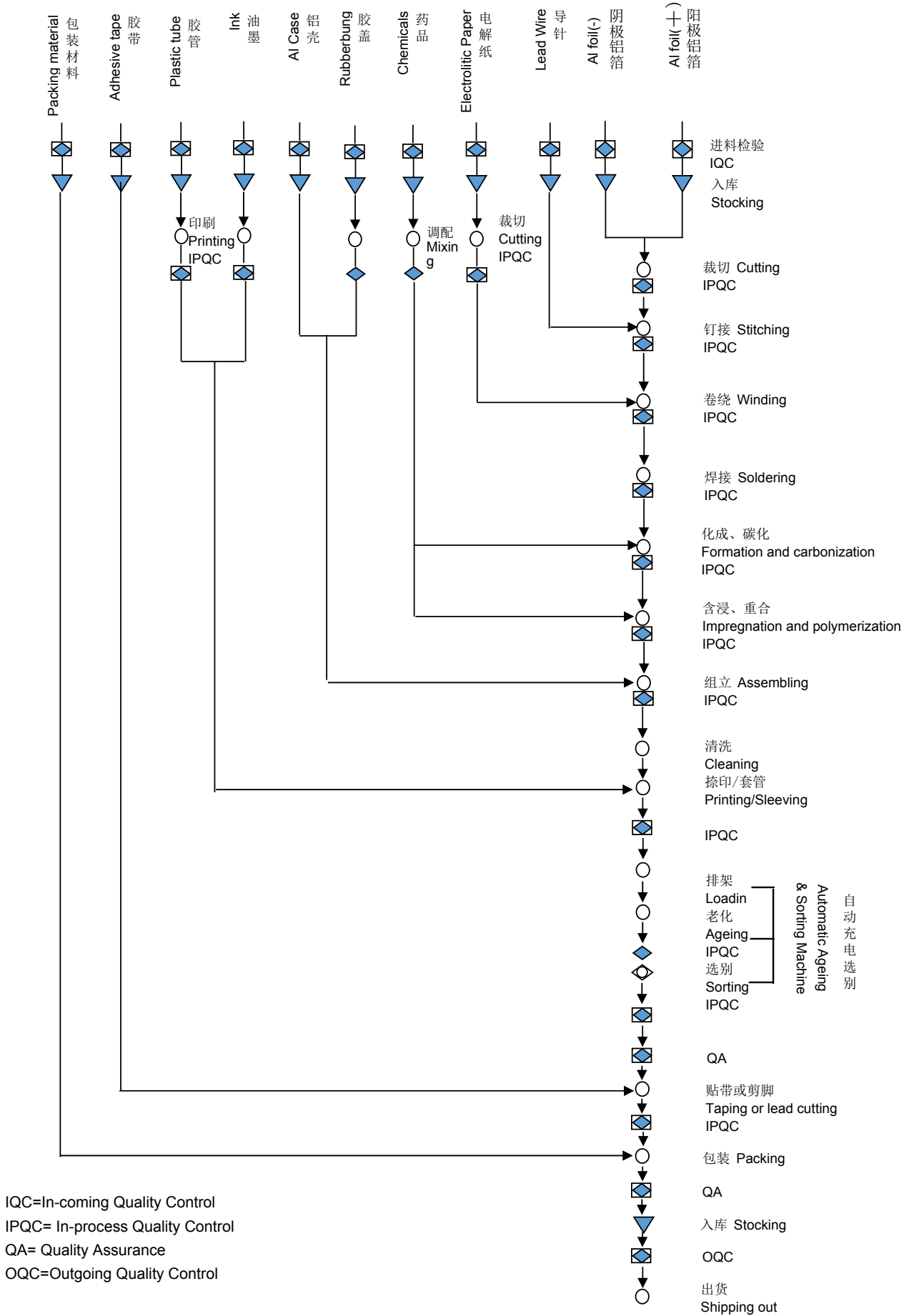

IQC=In-coming Quality Control
 IPQC= In-process Quality Control
 QA= Quality Assurance
 OQC=Outgoing Quality Control



E1 Series

- Super low ESR, high ripple current
- Load life of 2000 hours at 105°C
- RoHS Compliant

◆ 规格表 Specifications

| 项目 Items | 特性参数 Characteristics | | | | | | | | | | | |
|--|---|-------------------------------|---|-----|-----|-----|----------|----|----|----|----|------------------|
| 使用温度范围 Category Temperature Range | -55 ~ +105°C | | | | | | | | | | | |
| 额定工作电压范围 Rated Voltage Range | 2.5 ~ 25V | | | | | | | | | | | |
| 静电容量允许偏差 Capacitance tolerance | ±20%(M) (at 20°C, 120Hz) | | | | | | | | | | | |
| 漏电流 Leakage Current | 施加额定工作电压2分钟后读数, 小于或等于规格值 (at 20°C) I ≤ 0.2CV 或 500μA (取大值) Less than or equal to the specified value. After 2 minutes application of rated Voltage at 20°C | | | | | | | | | | | |
| 损耗角正切值 tanδ Dissipation Factor | Rated voltage (V) | 2.5 | 4 | 6.3 | 6.8 | 7.5 | 10 | 12 | 16 | 20 | 25 | (at 20°C, 120Hz) |
| | tanδ (Max.) | 0.08 | | | | | 0.12 | | | | | |
| 温度特性 Low Temperature Characteristics (Max. Impedance Ratio) | Z(-25°C)/Z(+20°C) | ≤ 1.25 | | | | | (100KHz) | | | | | |
| | Z(-55°C)/Z(+20°C) | ≤ 1.25 | | | | | | | | | | |
| 耐久性 Endurance | 105°C 施加额定工作电压2000小时, 恢复到20°C后, 产品性能应满足以下要求 The specifications listed below shall be satisfied when the capacitors are restored to 20°C after application of rated voltage for 2000 hours at 105°C. | | | | | | | | | | | |
| | Appearance | No significant damage | | | | | | | | | | |
| | Capacitance change | ≤ ±20% of the initial value | | | | | | | | | | |
| | D.F.(tanδ) | ≤ 150% of the specified value | | | | | | | | | | |
| | ESR | ≤ 150% of the specified value | | | | | | | | | | |
| | Leakage current | ≤ The specified value | | | | | | | | | | |
| 耐湿负荷特性 Damp Heat (Steady State) | 在60°C 温度, 湿度90%~95%RH的环境中, 施加额定电压1000小时后, 恢复到20°C后, 产品性能应满足以下要求 The specifications listed below shall be satisfied when the capacitors are restored to 20°C after application of rated voltage for 1000 hours at 60°C, 90%~95% RH. | | | | | | | | | | | |
| | Appearance | No significant damage | | | | | | | | | | |
| | Capacitance change | ≤ ±20% of the initial value | | | | | | | | | | |
| | D.F.(tanδ) | ≤ 150% of the specified value | | | | | | | | | | |
| | ESR | ≤ 150% of the specified value | | | | | | | | | | |
| | Leakage current | ≤ The specified value | | | | | | | | | | |
| 浪涌电压特性 (Surge Voltage) | 浪涌电压=额定电压× 1.15(V) Surge Voltage=Rated voltage × 1.15(V) 在105°C环境中, 按充电30秒; 放电5分30秒, 连续施加浪涌电压1000次(Rc=1kΩ), 待恢复后测试, 应满足以下要求 The capacitors shall be subjected to 1000 cycles each consisting of charge with the surge voltages specified at 105°C for 30 seconds through a protective resistor (Rc=1kΩ) and discharge for 5 minutes 30 seconds | | | | | | | | | | | |
| | Appearance | No significant damage | | | | | | | | | | |
| | Capacitance change | ≤ ±20% of the initial value | | | | | | | | | | |
| | D.F.(tanδ) | ≤ 150% of the specified value | | | | | | | | | | |
| | ESR | ≤ 150% of the specified value | | | | | | | | | | |
| | Leakage current | ≤ The specified value | | | | | | | | | | |

◆ 外形图 Dimensions (mm)

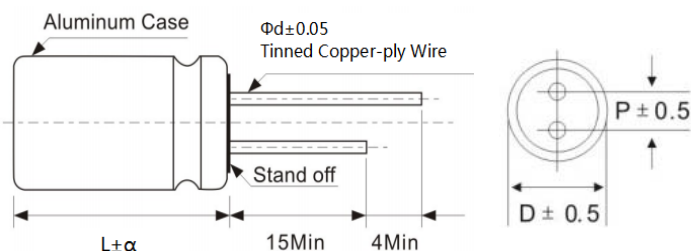

| | | | | |
|----|-----|-----|-----|-----|
| ΦD | 5 | 6.3 | 8 | 10 |
| P | 2.0 | 2.5 | 3.5 | 5.0 |
| Φd | 0.5 | 0.6 | 0.6 | 0.6 |

| | |
|---|-------------------|
| α | (L < 16) 1.0 |
| | (16 ≤ L < 22) 1.5 |
| | (L ≥ 22) 2.0 |



E1 Series

◆ 纹波电流修正系数 Rated Ripple Current Coefficient

| | | | | |
|------------------|------------------------|------------------------|--------------------------|---------------------------|
| 频率 Frequency(Hz) | 120Hz \cong f < 1kHz | 1kHz \cong f < 10kHz | 10kHz \cong f < 100kHz | 100kHz \cong f < 500kHz |
| 系数 Coefficient | 0.05 | 0.30 | 0.70 | 1.00 |

◆ 尺寸与个技术参数一览表 Standard Ratings

| Rated voltage (V) | Rated capacitance (uF) | Case size Φ D×L(mm) | ESR(m Ω) at 20°C, 100 KHz | Leakage Current (μ A) | Rated ripple current (mArms/105°C/100kHz) |
|-------------------|------------------------|--------------------------|-----------------------------------|----------------------------|---|
| 2.5 | 560 | 5*8 | 12 | 500 | 4100 |
| | 560 | 6.3*8 | 8 | 500 | 5100 |
| | 680 | 6.3*8 | 8 | 500 | 5100 |
| | 680 | 8*9 | 8 | 500 | 5900 |
| | 820 | 6.3*8 | 8 | 500 | 5200 |
| | 820 | 8*9 | 8 | 500 | 5900 |
| | 1000 | 8*9 | 8 | 500 | 5900 |
| | 1000 | 8*12 | 8 | 500 | 6100 |
| | 1200 | 8*9 | 8 | 600 | 5900 |
| | 1200 | 8*12 | 8 | 600 | 6100 |
| | 1500 | 8*12 | 8 | 750 | 6100 |
| 4 | 560 | 6.3*8 | 8 | 500 | 5100 |
| | 560 | 8*9 | 8 | 500 | 5900 |
| | 680 | 6.3*8 | 8 | 544 | 5100 |
| | 680 | 8*9 | 8 | 544 | 5900 |
| | 820 | 6.3*9 | 8 | 656 | 5200 |
| | 820 | 8*9 | 8 | 656 | 5900 |
| | 1000 | 6.3*12 | 8 | 800 | 5500 |
| | 1000 | 8*9 | 8 | 800 | 5900 |
| | 1200 | 6.3*12 | 8 | 960 | 5500 |
| | 1200 | 8*9 | 8 | 960 | 5900 |
| | 6.3 | 220 | 5*8 | 12 | 500 |
| 270 | | 5*8 | 12 | 500 | 3900 |
| 330 | | 5*8 | 12 | 500 | 4100 |
| 330 | | 6.3*8 | 10 | 500 | 4450 |
| 390 | | 5*9 | 12 | 500 | 4510 |
| 390 | | 6.3*8 | 10 | 500 | 4800 |
| 470 | | 5*9 | 12 | 592 | 4510 |
| 470 | | 6.3*8 | 8 | 592 | 4900 |
| 560 | | 6.3*8 | 8 | 706 | 5100 |
| 560 | | 8*9 | 8 | 706 | 5900 |
| 680 | | 6.3*8 | 8 | 857 | 5100 |
| 680 | | 8*9 | 8 | 857 | 5900 |



E1 Series

◆ 尺寸与个技术参数一览表 Standard Ratings

| Rated voltage (V) | Rated capacitance (uF) | Case size ΦD×L(mm) | ESR(mΩ) at 20°C, 100 KHz | Leakage Current (μA) | Rated ripple current (mArms/105°C/100kHz) |
|-------------------|------------------------|--------------------|--------------------------|----------------------|---|
| 6.3 | 820 | 6.3*9 | 8 | 1033 | 5200 |
| | 820 | 6.3*12 | 8 | 1033 | 5500 |
| | 820 | 8*9 | 8 | 1033 | 5900 |
| | 1000 | 6.3*12 | 8 | 1260 | 5500 |
| | 1000 | 8*9 | 8 | 1260 | 5900 |
| | 1000 | 8*12 | 8 | 1260 | 6100 |
| | 1200 | 8*9 | 8 | 1512 | 5900 |
| | 1200 | 8*12 | 8 | 1512 | 6100 |
| | 1500 | 8*12 | 8 | 1890 | 6100 |
| | 1500 | 10*12.5 | 8 | 1890 | 6200 |
| | 2200 | 10*12.5 | 8 | 2772 | 6200 |
| | 7.5 | 270 | 5*8 | 12 | 500 |
| 330 | | 6.3*8 | 10 | 500 | 4100 |
| 390 | | 6.3*8 | 10 | 585 | 4100 |
| 470 | | 6.3*8 | 10 | 705 | 4100 |
| 560 | | 6.3*8 | 10 | 840 | 4500 |
| 680 | | 6.3*12 | 10 | 1020 | 4500 |
| 680 | | 8*9 | 8 | 1020 | 4800 |
| 820 | | 6.3*12 | 10 | 1230 | 4500 |
| 820 | | 8*9 | 8 | 1230 | 4800 |
| 1000 | | 8*9 | 8 | 1500 | 4800 |
| 1000 | | 8*12 | 8 | 1500 | 5100 |
| 1200 | | 8*12 | 8 | 1800 | 5100 |
| 1200 | | 10*12.5 | 8 | 1800 | 5500 |
| 1500 | | 10*12.5 | 8 | 2250 | 5500 |
| 10 | | 220 | 5*8 | 15 | 500 |
| | 220 | 6.3*8 | 12 | 500 | 3500 |
| | 270 | 6.3*8 | 12 | 540 | 3500 |
| | 330 | 6.3*8 | 12 | 660 | 3750 |
| | 330 | 8*9 | 10 | 660 | 3800 |
| | 390 | 6.3*8 | 12 | 780 | 3750 |
| | 390 | 6.3*12 | 12 | 780 | 3900 |
| | 470 | 6.3*8 | 12 | 940 | 3850 |
| | 470 | 8*9 | 10 | 940 | 3950 |
| | 560 | 6.3*12 | 12 | 1120 | 3900 |
| | 560 | 8*9 | 10 | 1120 | 3950 |



E1 Series

◆ 尺寸与个技术参数一览表 Standard Ratings

| Rated voltage (V) | Rated capacitance (uF) | Case size ΦD×L(mm) | ESR(mΩ) at 20°C, 100 KHz | Leakage Current (μA) | Rated ripple current (mArms/105°C/100kHz) |
|-------------------|------------------------|--------------------|--------------------------|----------------------|---|
| 10 | 680 | 6.3*12 | 12 | 1360 | 4100 |
| | 680 | 8*9 | 10 | 1360 | 4200 |
| | 820 | 8*9 | 10 | 1640 | 4200 |
| | 820 | 8*12 | 8 | 1640 | 4500 |
| | 1000 | 8*12 | 8 | 2000 | 4500 |
| | 1000 | 10*12.5 | 8 | 2000 | 5200 |
| | 1200 | 10*12.5 | 8 | 2400 | 5200 |
| | 1500 | 10*12.5 | 8 | 3000 | 5200 |
| 12 | 220 | 5*9 | 15 | 528 | 2690 |
| | 220 | 6.3*8 | 13 | 528 | 2900 |
| | 270 | 6.3*8 | 13 | 648 | 2900 |
| | 330 | 6.3*8 | 13 | 792 | 2900 |
| | 390 | 6.3*8 | 13 | 936 | 2900 |
| | 470 | 6.3*12 | 13 | 1128 | 3500 |
| | 470 | 8*9 | 12 | 1128 | 3800 |
| | 560 | 6.3*12 | 13 | 1344 | 3500 |
| | 560 | 8*9 | 12 | 1344 | 3800 |
| | 680 | 8*9 | 12 | 1632 | 3800 |
| | 820 | 8*12 | 11 | 1968 | 4100 |
| | 1000 | 8*12 | 11 | 2400 | 4100 |
| | 1000 | 10*12.5 | 10 | 2400 | 4800 |
| | 1200 | 10*12.5 | 10 | 2880 | 4800 |
| | 1500 | 10*12.5 | 10 | 3600 | 4800 |
| | 16 | 100 | 5*8 | 15 | 500 |
| 150 | | 5*8 | 15 | 500 | 2100 |
| 150 | | 6.3*8 | 13 | 500 | 2900 |
| 180 | | 5*9 | 15 | 576 | 2690 |
| 180 | | 6.3*8 | 13 | 576 | 2900 |
| 220 | | 6.3*8 | 13 | 704 | 2900 |
| 220 | | 6.3*12 | 13 | 704 | 3500 |
| 220 | | 8*9 | 12 | 704 | 3500 |
| 270 | | 6.3*8 | 13 | 864 | 2900 |
| 270 | | 8*9 | 12 | 864 | 3500 |
| 270 | | 8*12 | 11 | 864 | 3790 |
| 330 | | 6.3*8 | 13 | 1056 | 2900 |
| 330 | | 6.3*12 | 13 | 1056 | 3500 |



E1 Series

◆ 尺寸与技术参数一览表 Standard Ratings

| Rated voltage (V) | Rated capacitance (uF) | Case size $\Phi D \times L$ (mm) | ESR (m Ω) at 20°C, 100 KHz | Leakage Current (μA) | Rated ripple current (mA _{rms} /105°C/100kHz) |
|-------------------|------------------------|----------------------------------|------------------------------------|-----------------------------|--|
| 16 | 330 | 8*9 | 12 | 1056 | 3500 |
| | 470 | 6.3*12 | 13 | 1504 | 3500 |
| | 470 | 8*9 | 12 | 1504 | 3500 |
| | 560 | 6.3*12 | 13 | 1792 | 3500 |
| | 560 | 8*9 | 12 | 1792 | 3500 |
| | 680 | 8*12 | 11 | 2176 | 4800 |
| | 820 | 8*12 | 11 | 2624 | 4800 |
| | 1000 | 10*12.5 | 10 | 3200 | 5100 |
| 25 | 68 | 6.3*8 | 25 | 500 | 2100 |
| | 68 | 8*9 | 20 | 500 | 2690 |
| | 82 | 6.3*8 | 25 | 500 | 2100 |
| | 82 | 8*9 | 20 | 500 | 2690 |
| | 100 | 6.3*8 | 25 | 500 | 2100 |
| | 100 | 8*9 | 18 | 500 | 2690 |
| | 100 | 8*12 | 18 | 500 | 2900 |
| | 150 | 8*9 | 18 | 750 | 2690 |
| | 150 | 8*12 | 18 | 750 | 2900 |
| | 180 | 8*12 | 18 | 900 | 2900 |
| | 220 | 8*12 | 18 | 1100 | 2900 |
| | 270 | 10*12.5 | 15 | 1350 | 3500 |
| | 330 | 10*12.5 | 15 | 1650 | 3500 |
| | 470 | 10*12.5 | 15 | 2350 | 3500 |



E2 Series

- Low ESR, high ripple current
- Load life of 2000 hours at 105°C
- RoHS Compliant

规格表 Specifications

| 项目 Items | 特性参数 Characteristics | | | | | | | | | | | |
|---|---|-------------------------------|---|-----|-----|-----|----------|----|----|----|----|------------------|
| 使用温度范围 Category Temperature Range | -55 ~ +105°C | | | | | | | | | | | |
| 额定工作电压范围 Rated Voltage Range | 2.5 ~ 25V | | | | | | | | | | | |
| 静电容量允许偏差 Capacitance tolerance | ±20%(M) (at 20°C, 120Hz) | | | | | | | | | | | |
| 漏电流 Leakage Current | 施加额定工作电压2分钟后读数, 小于或等于规格值 (at 20°C) I ≤ 0.2CV 或 500μA (取大值) Less than or equal to the specified value. After 2 minutes application of rated Voltage at 20°C | | | | | | | | | | | |
| 损耗角正切值 tanδ Dissipation Factor | Rated voltage (V) | 2.5 | 4 | 6.3 | 6.8 | 7.5 | 10 | 12 | 16 | 20 | 25 | (at 20°C, 120Hz) |
| | tanδ (Max.) | 0.08 | | | | | 0.12 | | | | | |
| 温度特性 Low Temperature Characteristics (Max.Impedance Ratio) | Z(-25°C)/Z(+20°C) | ≤ 1.25 | | | | | (100KHz) | | | | | |
| | Z(-55°C)/Z(+20°C) | ≤ 1.25 | | | | | | | | | | |
| 耐久性 Endurance | 105°C施加额定工作电压2000小时, 恢复到20°C后, 产品性能应满足以下要求 The specifications listed below shall be satisfied when the capacitors are restored to 20°C after application of rated voltage for 2000 hours at 105°C. | | | | | | | | | | | |
| | Appearance | No significant damage | | | | | | | | | | |
| | Capacitance change | ≤ ±20% of the initial value | | | | | | | | | | |
| | D.F.(tanδ) | ≤ 150% of the specified value | | | | | | | | | | |
| | ESR | ≤ 150% of the specified value | | | | | | | | | | |
| | Leakage current | ≤ The specified value | | | | | | | | | | |
| 耐湿负荷特性 Damp Heat (Steady State) | 在60°C 温度, 湿度90%~95%RH的环境中, 施加额定电压1000小时后, 恢复到20°C后, 产品性能应满足以下要求 The specifications listed below shall be satisfied when the capacitors are restored to 20°C after application of rated voltage for 1000 hours at 60°C, 90%~ 95% RH. | | | | | | | | | | | |
| | Appearance | No significant damage | | | | | | | | | | |
| | Capacitance change | ≤ ±20% of the initial value | | | | | | | | | | |
| | D.F.(tanδ) | ≤ 150% of the specified value | | | | | | | | | | |
| | ESR | ≤ 150% of the specified value | | | | | | | | | | |
| | Leakage current | ≤ The specified value | | | | | | | | | | |
| 浪涌电压特性 (Surge Voltage) | 浪涌电压=额定电压× 1.15(V) Surge Voltage=Rated voltage × 1.15(V) 在105°C环境中, 按充电30秒; 放电5分30秒, 连续施加浪涌电压1000次(Rc=1kΩ), 待恢复后测试, 应满足以下要求 The capacitors shall be subjected to 1000 cycles each consisting of charge with the surge voltages specified at 105°C for 30 seconds through a protective resistor (Rc=1kΩ) and discharge for 5 minutes 30 seconds | | | | | | | | | | | |
| | Appearance | No significant damage | | | | | | | | | | |
| | Capacitance change | ≤ ±20% of the initial value | | | | | | | | | | |
| | D.F.(tanδ) | ≤ 150% of the specified value | | | | | | | | | | |
| | ESR | ≤ 150% of the specified value | | | | | | | | | | |
| | Leakage current | ≤ The specified value | | | | | | | | | | |

外形图 Dimensions (mm)

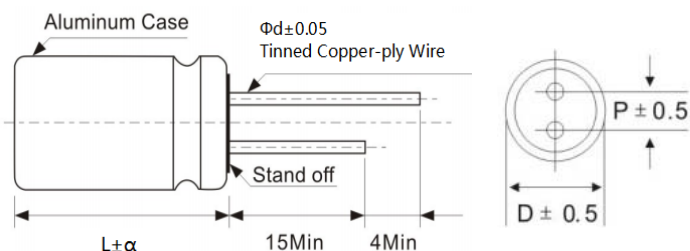

| | | | | |
|----|-----|-----|-----|-----|
| ΦD | 5 | 6.3 | 8 | 10 |
| P | 2.0 | 2.5 | 3.5 | 5.0 |
| Φd | 0.5 | 0.6 | 0.6 | 0.6 |

| | |
|---|-------------------|
| α | (L < 16) 1.0 |
| | (16 ≤ L < 22) 1.5 |
| | (L ≥ 22) 2.0 |



E2 Series

◆ 纹波电流修正系数 Rated Ripple Current Coefficient

| | | | | |
|------------------|------------------------|------------------------|--------------------------|---------------------------|
| 频率 Frequency(Hz) | 120Hz \cong f < 1kHz | 1kHz \cong f < 10kHz | 10kHz \cong f < 100kHz | 100kHz \cong f < 500kHz |
| 系数 Coefficient | 0.05 | 0.30 | 0.70 | 1.00 |

◆ 尺寸与个技术参数一览表 Standard Ratings

| Rated voltage (V) | Rated capacitance (uF) | Case size Φ D×L(mm) | ESR(m Ω) at 20°C, 100 KHz | Leakage Current (μ A) | Rated ripple current (mArms/105°C/100kHz) |
|-------------------|------------------------|--------------------------|-----------------------------------|----------------------------|---|
| 2.5 | 560 | 5*8 | 18 | 500 | 2900 |
| | 560 | 6.3*8 | 15 | 500 | 3500 |
| | 680 | 6.3*8 | 15 | 500 | 3500 |
| | 680 | 8*9 | 12 | 500 | 5200 |
| | 820 | 6.3*8 | 15 | 500 | 3500 |
| | 820 | 8*9 | 12 | 500 | 5200 |
| | 1000 | 8*9 | 12 | 500 | 5500 |
| | 1000 | 8*12 | 12 | 500 | 5500 |
| | 1200 | 8*9 | 12 | 600 | 5500 |
| | 1200 | 8*12 | 12 | 600 | 5500 |
| | 1500 | 8*12 | 12 | 750 | 5500 |
| 4 | 560 | 6.3*8 | 15 | 500 | 3100 |
| | 560 | 8*9 | 12 | 500 | 5100 |
| | 680 | 6.3*8 | 15 | 544 | 3500 |
| | 680 | 8*9 | 12 | 544 | 5100 |
| | 820 | 6.3*9 | 15 | 656 | 4100 |
| | 820 | 8*9 | 12 | 656 | 5100 |
| | 1000 | 6.3*12 | 15 | 800 | 4100 |
| | 1000 | 8*9 | 12 | 800 | 5100 |
| | 1200 | 6.3*12 | 15 | 960 | 4500 |
| | 1200 | 8*9 | 12 | 960 | 5100 |
| | 6.3 | 220 | 5*8 | 18 | 500 |
| 270 | | 5*8 | 18 | 500 | 2690 |
| 330 | | 5*8 | 18 | 500 | 2690 |
| 330 | | 6.3*8 | 15 | 500 | 3100 |
| 390 | | 5*9 | 16 | 500 | 3100 |
| 390 | | 6.3*8 | 15 | 500 | 3100 |
| 470 | | 5*9 | 15 | 592 | 3300 |
| 470 | | 6.3*8 | 15 | 592 | 4100 |
| 560 | | 6.3*8 | 15 | 706 | 4100 |
| 560 | | 8*9 | 12 | 706 | 5100 |
| 680 | | 6.3*8 | 15 | 857 | 4100 |
| 680 | | 8*9 | 12 | 857 | 5100 |



E2 Series

◆ 尺寸与个技术参数一览表 Standard Ratings

| Rated voltage (V) | Rated capacitance (uF) | Case size ΦD×L(mm) | ESR(mΩ) at 20°C, 100 KHz | Leakage Current (μA) | Rated ripple current (mArms/105°C/100kHz) |
|-------------------|------------------------|--------------------|--------------------------|----------------------|---|
| 6.3 | 820 | 6.3*9 | 15 | 1033 | 4500 |
| | 820 | 6.3*12 | 15 | 1033 | 4800 |
| | 820 | 8*9 | 12 | 1033 | 5100 |
| | 1000 | 6.3*12 | 14 | 1260 | 4800 |
| | 1000 | 8*9 | 12 | 1260 | 5100 |
| | 1000 | 8*12 | 12 | 1260 | 5500 |
| | 1200 | 8*9 | 12 | 1512 | 5100 |
| | 1200 | 8*12 | 12 | 1512 | 5500 |
| | 1500 | 8*12 | 12 | 1890 | 5500 |
| | 1500 | 10*12.5 | 12 | 1890 | 5900 |
| | 2200 | 10*12.5 | 12 | 2772 | 5900 |
| | 7.5 | 270 | 5*8 | 18 | 500 |
| 330 | | 6.3*8 | 16 | 500 | 3100 |
| 390 | | 6.3*8 | 16 | 585 | 3500 |
| 470 | | 6.3*8 | 16 | 705 | 3500 |
| 560 | | 6.3*8 | 16 | 840 | 3500 |
| 680 | | 6.3*12 | 16 | 1020 | 3800 |
| 680 | | 8*9 | 12 | 1020 | 4800 |
| 820 | | 6.3*12 | 16 | 1230 | 3800 |
| 820 | | 8*9 | 12 | 1230 | 4800 |
| 1000 | | 8*9 | 12 | 1500 | 4800 |
| 1000 | | 8*12 | 12 | 1500 | 5100 |
| 1200 | | 8*12 | 12 | 1800 | 5100 |
| 1200 | | 10*12.5 | 12 | 1800 | 5500 |
| 1500 | | 10*12.5 | 12 | 2250 | 5500 |
| 10 | | 220 | 5*8 | 20 | 500 |
| | 220 | 6.3*8 | 16 | 500 | 2900 |
| | 270 | 6.3*8 | 16 | 540 | 2900 |
| | 330 | 6.3*8 | 16 | 660 | 3100 |
| | 330 | 8*9 | 14 | 660 | 4800 |
| | 390 | 6.3*8 | 16 | 780 | 3100 |
| | 390 | 6.3*12 | 16 | 780 | 3500 |
| | 470 | 6.3*8 | 16 | 940 | 3100 |
| | 470 | 8*9 | 14 | 940 | 4800 |
| | 560 | 6.3*12 | 16 | 1120 | 3500 |
| | 560 | 8*9 | 16 | 1120 | 4800 |



E2 Series

◆ 尺寸与个技术参数一览表 Standard Ratings

| Rated voltage (V) | Rated capacitance (uF) | Case size ΦD×L(mm) | ESR(mΩ) at 20°C, 100 KHz | Leakage Current (μA) | Rated ripple current (mArms/105°C/100kHz) |
|-------------------|------------------------|--------------------|--------------------------|----------------------|---|
| 10 | 680 | 6.3*12 | 16 | 1360 | 3500 |
| | 680 | 8*9 | 14 | 1360 | 4800 |
| | 820 | 8*9 | 14 | 1640 | 4800 |
| | 820 | 8*12 | 14 | 1640 | 5100 |
| | 1000 | 8*12 | 14 | 2000 | 5100 |
| | 1000 | 10*12.5 | 14 | 2000 | 5500 |
| | 1200 | 10*12.5 | 14 | 2400 | 5500 |
| | 1500 | 10*12.5 | 14 | 3000 | 5500 |
| 12 | 220 | 5*9 | 20 | 528 | 2690 |
| | 220 | 6.3*8 | 18 | 528 | 3160 |
| | 270 | 6.3*8 | 18 | 648 | 3160 |
| | 330 | 6.3*8 | 18 | 792 | 3200 |
| | 390 | 6.3*8 | 18 | 936 | 3200 |
| | 470 | 6.3*12 | 18 | 1128 | 3500 |
| | 470 | 8*9 | 15 | 1128 | 4100 |
| | 560 | 6.3*12 | 18 | 1344 | 3500 |
| | 560 | 8*9 | 15 | 1344 | 4100 |
| | 680 | 8*9 | 15 | 1632 | 4100 |
| | 820 | 8*12 | 15 | 1968 | 4500 |
| | 1000 | 8*12 | 15 | 2400 | 4500 |
| | 1000 | 10*12.5 | 12 | 2400 | 5200 |
| | 1200 | 10*12.5 | 12 | 2880 | 5200 |
| | 1500 | 10*12.5 | 12 | 3600 | 5200 |
| | 16 | 100 | 5*8 | 25 | 500 |
| 150 | | 5*8 | 25 | 500 | 2100 |
| 150 | | 6.3*8 | 20 | 500 | 2690 |
| 180 | | 5*9 | 22 | 576 | 2690 |
| 180 | | 6.3*8 | 20 | 576 | 2900 |
| 220 | | 6.3*8 | 18 | 704 | 3100 |
| 220 | | 6.3*12 | 18 | 704 | 3500 |
| 220 | | 8*9 | 15 | 704 | 4100 |
| 270 | | 6.3*8 | 18 | 864 | 3100 |
| 270 | | 8*9 | 15 | 864 | 4100 |
| 270 | | 8*12 | 15 | 864 | 4500 |
| 330 | | 6.3*8 | 18 | 1056 | 3100 |
| 330 | | 6.3*12 | 18 | 1056 | 4100 |



E2 Series

◆ 尺寸与技术参数一览表 Standard Ratings

| Rated voltage (V) | Rated capacitance (uF) | Case size $\Phi D \times L$ (mm) | ESR (m Ω) at 20°C, 100 KHz | Leakage Current (μA) | Rated ripple current (mA _{rms} /105°C/100kHz) |
|-------------------|------------------------|----------------------------------|------------------------------------|-----------------------------|--|
| 16 | 330 | 8*9 | 15 | 1056 | 4100 |
| | 470 | 6.3*12 | 18 | 1504 | 3500 |
| | 470 | 8*9 | 15 | 1504 | 4100 |
| | 560 | 6.3*12 | 18 | 1792 | 3500 |
| | 560 | 8*9 | 15 | 1792 | 4100 |
| | 680 | 8*12 | 15 | 2176 | 4500 |
| | 820 | 8*12 | 15 | 2624 | 4500 |
| | 1000 | 10*12.5 | 14 | 3200 | 5200 |
| | 1500 | 10*12.5 | 14 | 4800 | 5200 |
| 25 | 68 | 6.3*8 | 40 | 500 | 2100 |
| | 68 | 8*9 | 30 | 500 | 3500 |
| | 82 | 6.3*8 | 40 | 500 | 2150 |
| | 82 | 8*9 | 30 | 500 | 3800 |
| | 100 | 6.3*8 | 40 | 500 | 2200 |
| | 100 | 8*9 | 30 | 500 | 3900 |
| | 100 | 8*12 | 25 | 500 | 4200 |
| | 220 | 6.3*12 | 35 | 1100 | 3800 |
| | 220 | 8*12 | 25 | 1100 | 4200 |
| | 330 | 6.3*12 | 35 | 1650 | 3800 |
| | 330 | 8*12 | 25 | 1650 | 4200 |
| | 560 | 8*12 | 25 | 2800 | 4200 |
| | 680 | 8*12 | 25 | 3400 | 4200 |
| | 820 | 10*12.5 | 20 | 4100 | 4800 |



E4 Series

- Low ESR, high ripple current, high temperature
- Load life of 2000 hours at 125°C
- RoHS Compliant

◆ 规格表 Specifications

| 项目 Items | 特性参数 Characteristics | | | | | | | | | | | |
|--|---|-------------------------------|---|-----|-----|-----|----------|----|----|----|----|------------------|
| 使用温度范围 Category Temperature Range | -55 ~ +125°C | | | | | | | | | | | |
| 额定工作电压范围 Rated Voltage Range | 2.5 ~ 25V | | | | | | | | | | | |
| 静电容量允许偏差 Capacitance tolerance | ±20%(M) (at 20°C, 120Hz) | | | | | | | | | | | |
| 漏电流 Leakage Current | 施加额定工作电压2分钟后读数, 小于或等于规格值 (at 20°C) I ≤ 0.2CV 或 500μA (取大值) Less than or equal to the specified value. After 2 minutes application of rated Voltage at 20°C | | | | | | | | | | | |
| 损耗角正切值 tanδ Dissipation Factor | Rated voltage (V) | 2.5 | 4 | 6.3 | 6.8 | 7.5 | 10 | 12 | 16 | 20 | 25 | (at 20°C, 120Hz) |
| | tanδ (Max.) | 0.08 | | | | | 0.12 | | | | | |
| 温度特性 Low Temperature Characteristics (Max. Impedance Ratio) | Z(-25°C)/Z(+20°C) | ≤ 1.25 | | | | | (100KHz) | | | | | |
| | Z(-55°C)/Z(+20°C) | ≤ 1.25 | | | | | | | | | | |
| 耐久性 Endurance | 125°C 施加额定工作电压2000小时, 恢复到20°C后, 产品性能应满足以下要求 The specifications listed below shall be satisfied when the capacitors are restored to 20°C after application of rated voltage for 2000 hours at 125°C. | | | | | | | | | | | |
| | Appearance | No significant damage | | | | | | | | | | |
| | Capacitance change | ≤ ±20% of the initial value | | | | | | | | | | |
| | D.F.(tanδ) | ≤ 150% of the specified value | | | | | | | | | | |
| | ESR | ≤ 150% of the specified value | | | | | | | | | | |
| | Leakage current | ≤ The specified value | | | | | | | | | | |
| 耐湿负荷特性 Damp Heat (Steady State) | 在60°C 温度, 湿度90%~95%RH的环境中, 施加额定电压1000小时后, 恢复到20°C后, 产品性能应满足以下要求 The specifications listed below shall be satisfied when the capacitors are restored to 20°C after application of rated voltage for 1000 hours at 60°C, 90%~95% RH. | | | | | | | | | | | |
| | Appearance | No significant damage | | | | | | | | | | |
| | Capacitance change | ≤ ±20% of the initial value | | | | | | | | | | |
| | D.F.(tanδ) | ≤ 150% of the specified value | | | | | | | | | | |
| | ESR | ≤ 150% of the specified value | | | | | | | | | | |
| | Leakage current | ≤ The specified value | | | | | | | | | | |
| 浪涌电压特性 (Surge Voltage) | 浪涌电压=额定电压× 1.15(V) Surge Voltage=Rated voltage × 1.15(V) 在125°C环境中, 按充电30秒; 放电5分30秒, 连续施加浪涌电压1000次(Rc=1kΩ), 待恢复后测试, 应满足以下要求 The capacitors shall be subjected to 1000 cycles each consisting of charge with the surge voltages specified at 125°C for 30 seconds through a protective resistor (Rc=1kΩ) and discharge for 5 minutes 30 seconds | | | | | | | | | | | |
| | Appearance | No significant damage | | | | | | | | | | |
| | Capacitance change | ≤ ±20% of the initial value | | | | | | | | | | |
| | D.F.(tanδ) | ≤ 150% of the specified value | | | | | | | | | | |
| | ESR | ≤ 150% of the specified value | | | | | | | | | | |
| | Leakage current | ≤ The specified value | | | | | | | | | | |

◆ 外形图 Dimensions (mm)

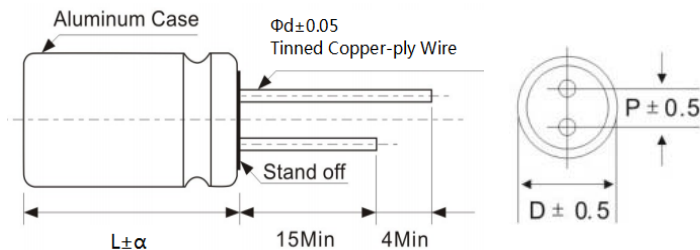

| | | | | |
|----|-----|-----|-----|-----|
| ΦD | 5 | 6.3 | 8 | 10 |
| P | 2.0 | 2.5 | 3.5 | 5.0 |
| Φd | 0.5 | 0.6 | 0.6 | 0.6 |

| | |
|---|------------------|
| α | (L < 16)1.0 |
| | (16 ≤ L < 22)1.5 |
| | (L ≥ 22)2.0 |



E4 Series

◆ 纹波电流修正系数 Rated Ripple Current Coefficient

| 频率 Frequency(Hz) | 120Hz \cong f < 1kHz | 1kHz \cong f < 10kHz | 10kHz \cong f < 100kHz | 100kHz \cong f < 500kHz |
|------------------|------------------------|------------------------|--------------------------|---------------------------|
| 系数 Coefficient | 0.05 | 0.30 | 0.70 | 1.00 |

◆ 尺寸与个技术参数一览表 Standard Ratings

| Rated voltage (V) | Rated capacitance (μ F) | Case size Φ D×L(mm) | ESR($m\Omega$) at 20°C, 100 KHz | Leakage Current (μ A) | Rated ripple current (mA _{rms} /125°C/100kHz) |
|-------------------|------------------------------|--------------------------|-----------------------------------|----------------------------|--|
| 2.5 | 560 | 6.3*8 | 10 | 500 | 1700 |
| | 680 | 6.3*8 | 10 | 500 | 1700 |
| | 820 | 8*9 | 10 | 500 | 1929 |
| | 1000 | 8*9 | 10 | 500 | 1929 |
| | 1000 | 8*12 | 10 | 500 | 1929 |
| | 1500 | 8*12 | 10 | 750 | 1929 |
| | 2200 | 10*12.5 | 9 | 1100 | 2100 |
| 4 | 560 | 6.3*8 | 12 | 500 | 1700 |
| | 560 | 8*9 | 10 | 500 | 1929 |
| | 680 | 6.3*8 | 12 | 544 | 1700 |
| | 680 | 8*9 | 10 | 544 | 1929 |
| | 820 | 8*9 | 10 | 656 | 1929 |
| | 1000 | 8*9 | 10 | 800 | 1929 |
| | 1000 | 8*12 | 10 | 800 | 1929 |
| | 1500 | 10*12.5 | 9 | 1200 | 2100 |
| 6.3 | 220 | 5*8 | 18 | 500 | 1500 |
| | 220 | 6.3*8 | 15 | 500 | 1700 |
| | 330 | 6.3*8 | 15 | 500 | 1700 |
| | 470 | 6.3*8 | 15 | 592 | 1700 |
| | 470 | 8*9 | 12 | 592 | 1929 |
| | 560 | 6.3*8 | 15 | 706 | 1700 |
| | 560 | 8*9 | 12 | 706 | 1929 |
| | 680 | 8*9 | 12 | 857 | 1929 |
| | 820 | 8*9 | 12 | 1033 | 1929 |
| | 1000 | 8*9 | 12 | 1260 | 1929 |
| | 1000 | 8*12 | 10 | 1260 | 1929 |
| | 1000 | 10*12.5 | 9 | 1260 | 2100 |
| | 1500 | 8*12 | 10 | 1890 | 1929 |
| | 1500 | 10*12.5 | 9 | 1890 | 2100 |
| | 2200 | 10*12.5 | 9 | 2772 | 2100 |
| 7.5 | 220 | 6.3*8 | 15 | 500 | 1700 |
| | 330 | 6.3*8 | 15 | 500 | 1700 |
| | 470 | 6.3*8 | 15 | 705 | 1700 |
| | 560 | 6.3*8 | 15 | 840 | 1700 |



E4 Series

◆ 尺寸与个技术参数一览表 Standard Ratings

| Rated voltage (V) | Rated capacitance (uF) | Case size ΦD×L(mm) | ESR(mΩ) at 20°C, 100 KHz | Leakage Current (μA) | Rated ripple current (mArms/125°C/100kHz) |
|-------------------|------------------------|--------------------|--------------------------|----------------------|---|
| 7.5 | 820 | 8*9 | 12 | 1230 | 1929 |
| | 820 | 8*12 | 10 | 1230 | 1929 |
| | 1000 | 8*12 | 10 | 1500 | 1929 |
| | 1000 | 10*12.5 | 9 | 1500 | 2100 |
| | 1500 | 10*12.5 | 9 | 2250 | 2100 |
| 10 | 220 | 6.3*8 | 16 | 500 | 1700 |
| | 330 | 6.3*8 | 16 | 660 | 1700 |
| | 470 | 8*9 | 14 | 940 | 1929 |
| | 560 | 8*9 | 14 | 1120 | 1929 |
| | 560 | 8*12 | 12 | 1120 | 1929 |
| | 680 | 8*12 | 12 | 1360 | 1929 |
| | 820 | 8*12 | 12 | 1640 | 1929 |
| | 820 | 10*12.5 | 10 | 1640 | 2100 |
| | 1000 | 10*12.5 | 10 | 2000 | 2100 |
| 16 | 100 | 6.3*8 | 18 | 500 | 920 |
| | 220 | 8*9 | 16 | 704 | 1500 |
| | 220 | 8*12 | 14 | 704 | 1770 |
| | 330 | 8*12 | 14 | 1056 | 1770 |
| | 330 | 10*12.5 | 12 | 1056 | 1929 |
| | 470 | 8*12 | 14 | 1504 | 1770 |
| | 470 | 10*12.5 | 12 | 1504 | 1929 |
| | 560 | 10*12.5 | 12 | 1792 | 1929 |
| 25 | 22 | 5*7 | 50 | 500 | 950 |
| | 100 | 6.3*8 | 40 | 500 | 1100 |
| | 220 | 6.3*12 | 35 | 1100 | 1310 |
| | 220 | 8*12 | 25 | 1100 | 1450 |
| | 330 | 8*12 | 25 | 1650 | 1450 |
| | 330 | 10*12.5 | 20 | 1650 | 1800 |
| | 470 | 10*12.5 | 20 | 2350 | 1800 |
| | 560 | 10*12.5 | 20 | 2800 | 1800 |
| | 680 | 10*12.5 | 20 | 3400 | 1800 |



E5 Series

- Low ESR, high ripple current, long life
- Load life of 5000 hours at 105°C
- RoHS Compliant

◆ 规格表 Specifications

| 项目 Items | 特性参数 Characteristics | | | | | | | | | | | |
|--|---|-------------------------------|---|-----|-----|-----|----------|----|----|----|----|------------------|
| 使用温度范围 Category Temperature Range | -55 ~ +105°C | | | | | | | | | | | |
| 额定工作电压范围 Rated Voltage Range | 2.5 ~ 25V | | | | | | | | | | | |
| 静电容量允许偏差 Capacitance tolerance | ±20%(M) (at 20°C, 120Hz) | | | | | | | | | | | |
| 漏电流 Leakage Current | 施加额定工作电压2分钟后读数, 小于或等于规格值 (at 20°C) I ≤ 0.2CV 或 500μA (取大值) Less than or equal to the specified value. After 2 minutes application of rated Voltage at 20°C | | | | | | | | | | | |
| 损耗角正切值 tanδ Dissipation Factor | Rated voltage (V) | 2.5 | 4 | 6.3 | 6.8 | 7.5 | 10 | 12 | 16 | 20 | 25 | (at 20°C, 120Hz) |
| | tanδ (Max.) | 0.08 | | | | | 0.12 | | | | | |
| 温度特性 Low Temperature Characteristics (Max. Impedance Ratio) | Z(-25°C)/Z(+20°C) | ≤ 1.25 | | | | | (100KHz) | | | | | |
| | Z(-55°C)/Z(+20°C) | ≤ 1.25 | | | | | | | | | | |
| 耐久性 Endurance | 105°C 施加额定工作电压5000小时, 恢复到20°C后, 产品性能应满足以下要求 The specifications listed below shall be satisfied when the capacitors are restored to 20°C after application of rated voltage for 5000 hours at 105°C. | | | | | | | | | | | |
| | Appearance | No significant damage | | | | | | | | | | |
| | Capacitance change | ≤ ±20% of the initial value | | | | | | | | | | |
| | D.F.(tanδ) | ≤ 150% of the specified value | | | | | | | | | | |
| | ESR | ≤ 150% of the specified value | | | | | | | | | | |
| | Leakage current | ≤ The specified value | | | | | | | | | | |
| 耐湿负荷特性 Damp Heat (Steady State) | 在60°C 温度, 湿度90%~95%RH的环境中, 施加额定电压1000小时后, 恢复到20°C后, 产品性能应满足以下要求 The specifications listed below shall be satisfied when the capacitors are restored to 20°C after application of rated voltage for 1000 hours at 60°C, 90%~95% RH. | | | | | | | | | | | |
| | Appearance | No significant damage | | | | | | | | | | |
| | Capacitance change | ≤ ±20% of the initial value | | | | | | | | | | |
| | D.F.(tanδ) | ≤ 150% of the specified value | | | | | | | | | | |
| | ESR | ≤ 150% of the specified value | | | | | | | | | | |
| | Leakage current | ≤ The specified value | | | | | | | | | | |
| 浪涌电压特性 (Surge Voltage) | 浪涌电压=额定电压× 1.15(V) Surge Voltage=Rated voltage × 1.15(V) 在105°C环境中, 按充电30秒; 放电5分30秒, 连续施加浪涌电压1000次(Rc=1kΩ), 待恢复后测试, 应满足以下要求 The capacitors shall be subjected to 1000 cycles each consisting of charge with the surge voltages specified at 105°C for 30 seconds through a protective resistor (Rc=1kΩ) and discharge for 5 minutes 30 seconds | | | | | | | | | | | |
| | Appearance | No significant damage | | | | | | | | | | |
| | Capacitance change | ≤ ±20% of the initial value | | | | | | | | | | |
| | D.F.(tanδ) | ≤ 150% of the specified value | | | | | | | | | | |
| | ESR | ≤ 150% of the specified value | | | | | | | | | | |
| | Leakage current | ≤ The specified value | | | | | | | | | | |

◆ 外形图 Dimensions (mm)

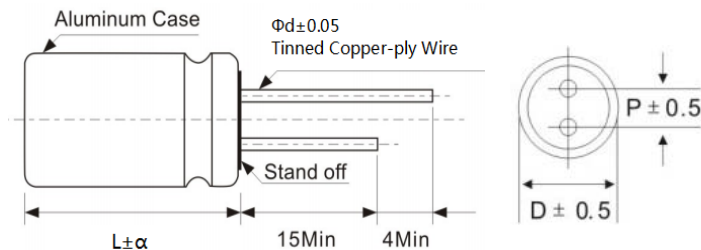

| | | | | |
|----|-----|-----|-----|-----|
| ΦD | 5 | 6.3 | 8 | 10 |
| P | 2.0 | 2.5 | 3.5 | 5.0 |
| Φd | 0.5 | 0.6 | 0.6 | 0.6 |

| | |
|---|-------------------|
| α | (L < 16) 1.0 |
| | (16 ≤ L < 22) 1.5 |
| | (L ≥ 22) 2.0 |



E5 Series

◆ 纹波电流修正系数 Rated Ripple Current Coefficient

| 频率 Frequency(Hz) | 120Hz \cong f < 1kHz | 1kHz \cong f < 10kHz | 10kHz \cong f < 100kHz | 100kHz \cong f < 500kHz |
|------------------|------------------------|------------------------|--------------------------|---------------------------|
| 系数 Coefficient | 0.05 | 0.30 | 0.70 | 1.00 |

◆ 尺寸与个技术参数一览表 Standard Ratings

| Rated voltage (V) | Rated capacitance (μ F) | Case size Φ D×L(mm) | ESR($m\Omega$) at 20°C, 100 KHz | Leakage Current (μ A) | Rated ripple current (mA _{rms} /105°C/100kHz) |
|-------------------|------------------------------|--------------------------|-----------------------------------|----------------------------|--|
| 2.5 | 560 | 5*8 | 15 | 500 | 2900 |
| | 560 | 6.3*8 | 15 | 500 | 3500 |
| | 680 | 6.3*8 | 15 | 500 | 3500 |
| | 680 | 8*9 | 12 | 500 | 5200 |
| | 820 | 6.3*8 | 15 | 500 | 3500 |
| | 820 | 8*9 | 12 | 500 | 5200 |
| | 1000 | 8*9 | 12 | 500 | 5500 |
| | 1000 | 8*12 | 12 | 500 | 5500 |
| | 1200 | 8*9 | 12 | 600 | 5500 |
| | 1200 | 8*12 | 12 | 600 | 5500 |
| | 1500 | 8*12 | 12 | 750 | 5500 |
| 4 | 560 | 6.3*8 | 15 | 500 | 3100 |
| | 560 | 8*9 | 12 | 500 | 5100 |
| | 680 | 6.3*8 | 15 | 544 | 3500 |
| | 680 | 8*9 | 12 | 544 | 5100 |
| | 820 | 6.3*9 | 15 | 656 | 4100 |
| | 820 | 8*9 | 12 | 656 | 5100 |
| | 1000 | 6.3*12 | 15 | 800 | 4100 |
| | 1000 | 8*9 | 12 | 800 | 5100 |
| | 1200 | 6.3*12 | 15 | 960 | 4500 |
| | 1200 | 8*9 | 12 | 960 | 5100 |
| | 6.3 | 220 | 5*8 | 15 | 500 |
| 270 | | 5*8 | 15 | 500 | 2690 |
| 330 | | 5*8 | 15 | 500 | 2690 |
| 330 | | 6.3*8 | 15 | 500 | 3100 |
| 390 | | 5*9 | 15 | 500 | 3100 |
| 390 | | 6.3*8 | 15 | 500 | 3100 |
| 470 | | 5*9 | 15 | 592 | 3300 |
| 470 | | 6.3*8 | 15 | 592 | 4100 |
| 560 | | 6.3*8 | 15 | 706 | 4100 |
| 560 | | 8*9 | 12 | 706 | 5100 |
| 680 | | 6.3*8 | 15 | 857 | 4100 |
| 680 | | 8*9 | 12 | 857 | 5100 |



E5 Series

◆ 尺寸与个技术参数一览表 Standard Ratings

| Rated voltage (V) | Rated capacitance (uF) | Case size $\Phi D \times L$ (mm) | ESR(m Ω) at 20°C, 100 KHz | Leakage Current (μA) | Rated ripple current (mA _{rms} /105°C/100kHz) |
|-------------------|------------------------|----------------------------------|-----------------------------------|-----------------------------|--|
| 6.3 | 820 | 6.3*9 | 15 | 1033 | 4500 |
| | 820 | 6.3*12 | 15 | 1033 | 4800 |
| | 820 | 8*9 | 12 | 1033 | 5100 |
| | 1000 | 6.3*12 | 14 | 1260 | 4800 |
| | 1000 | 8*9 | 12 | 1260 | 5100 |
| | 1000 | 8*12 | 12 | 1260 | 5500 |
| | 1200 | 8*9 | 12 | 1512 | 5100 |
| | 1200 | 8*12 | 12 | 1512 | 5500 |
| | 1500 | 8*12 | 12 | 1890 | 5500 |
| | 1500 | 10*12.5 | 12 | 1890 | 5900 |
| | 2200 | 10*12.5 | 12 | 2772 | 5900 |
| 7.5 | 270 | 5*8 | 18 | 500 | 2690 |
| | 330 | 6.3*8 | 16 | 500 | 3100 |
| | 390 | 6.3*8 | 16 | 585 | 3500 |
| | 470 | 6.3*8 | 16 | 705 | 3500 |
| | 560 | 6.3*8 | 16 | 840 | 3500 |
| | 680 | 6.3*12 | 16 | 1020 | 3800 |
| | 680 | 8*9 | 12 | 1020 | 4800 |
| | 820 | 6.3*12 | 16 | 1230 | 3800 |
| | 820 | 8*9 | 12 | 1230 | 4800 |
| | 1000 | 8*9 | 12 | 1500 | 4800 |
| | 1000 | 8*12 | 12 | 1500 | 5100 |
| | 1200 | 8*12 | 12 | 1800 | 5100 |
| | 1200 | 10*12.5 | 12 | 1800 | 5500 |
| | 1500 | 10*12.5 | 12 | 2250 | 5500 |
| 10 | 220 | 5*8 | 20 | 500 | 2200 |
| | 220 | 6.3*8 | 16 | 500 | 2900 |
| | 270 | 6.3*8 | 16 | 540 | 2900 |
| | 330 | 6.3*8 | 16 | 660 | 3100 |
| | 330 | 8*9 | 14 | 660 | 4800 |
| | 390 | 6.3*8 | 16 | 780 | 3100 |
| | 390 | 6.3*12 | 16 | 780 | 3500 |
| | 470 | 6.3*8 | 16 | 940 | 3100 |
| | 470 | 8*9 | 14 | 940 | 4800 |
| | 560 | 6.3*12 | 16 | 1120 | 3500 |
| | 560 | 8*9 | 16 | 1120 | 4800 |



E5 Series

◆ 尺寸与个技术参数一览表 Standard Ratings

| Rated voltage (V) | Rated capacitance (uF) | Case size ΦD×L(mm) | ESR(mΩ) at 20°C, 100 KHz | Leakage Current (μA) | Rated ripple current (mArms/105°C/100kHz) |
|-------------------|------------------------|--------------------|--------------------------|----------------------|---|
| 10 | 680 | 6.3*12 | 16 | 1360 | 3500 |
| | 680 | 8*9 | 14 | 1360 | 4800 |
| | 820 | 8*9 | 14 | 1640 | 4800 |
| | 820 | 8*12 | 14 | 1640 | 5100 |
| | 1000 | 8*12 | 14 | 2000 | 5100 |
| | 1000 | 10*12.5 | 14 | 2000 | 5500 |
| | 1200 | 10*12.5 | 14 | 2400 | 5500 |
| | 1500 | 10*12.5 | 14 | 3000 | 5500 |
| 12 | 220 | 5*9 | 20 | 528 | 2690 |
| | 220 | 6.3*8 | 18 | 528 | 3160 |
| | 270 | 6.3*8 | 18 | 648 | 3160 |
| | 330 | 6.3*8 | 18 | 792 | 3200 |
| | 390 | 6.3*8 | 18 | 936 | 3200 |
| | 470 | 6.3*12 | 18 | 1128 | 3500 |
| | 470 | 8*9 | 15 | 1128 | 4100 |
| | 560 | 6.3*12 | 18 | 1344 | 3500 |
| | 560 | 8*9 | 15 | 1344 | 4100 |
| | 680 | 8*9 | 15 | 1632 | 4100 |
| | 820 | 8*12 | 15 | 1968 | 4500 |
| | 1000 | 8*12 | 15 | 2400 | 4500 |
| | 1000 | 10*12.5 | 12 | 2400 | 5200 |
| | 1200 | 10*12.5 | 12 | 2880 | 5200 |
| | 1500 | 10*12.5 | 12 | 3600 | 5200 |
| | 16 | 100 | 5*8 | 25 | 500 |
| 150 | | 5*8 | 25 | 500 | 2100 |
| 150 | | 6.3*8 | 20 | 500 | 2690 |
| 180 | | 5*9 | 22 | 576 | 2690 |
| 180 | | 6.3*8 | 20 | 576 | 2900 |
| 220 | | 6.3*8 | 18 | 704 | 3100 |
| 220 | | 6.3*12 | 18 | 704 | 3500 |
| 220 | | 8*9 | 15 | 704 | 4100 |
| 270 | | 6.3*8 | 18 | 864 | 3100 |
| 270 | | 8*9 | 15 | 864 | 4100 |
| 270 | | 8*12 | 15 | 864 | 4500 |
| 330 | | 6.3*8 | 18 | 1056 | 3100 |
| 330 | | 6.3*12 | 18 | 1056 | 4100 |



E5 Series

◆ 尺寸与技术参数一览表 Standard Ratings

| Rated voltage (V) | Rated capacitance (uF) | Case size $\Phi D \times L$ (mm) | ESR (m Ω) at 20°C, 100 KHz | Leakage Current (μA) | Rated ripple current (mA _{rms} /105°C/100kHz) |
|-------------------|------------------------|----------------------------------|------------------------------------|-----------------------------|--|
| 16 | 330 | 8*9 | 15 | 1056 | 4100 |
| | 470 | 6.3*11 | 18 | 1504 | 3500 |
| | 470 | 8*9 | 15 | 1504 | 4100 |
| | 560 | 6.3*11 | 18 | 1792 | 3500 |
| | 560 | 8*9 | 15 | 1792 | 4100 |
| | 680 | 8*12 | 15 | 2176 | 4500 |
| | 820 | 8*12 | 15 | 2624 | 4500 |
| | 1000 | 10*12.5 | 14 | 3200 | 5200 |
| 25 | 68 | 6.3*8 | 30 | 500 | 2100 |
| | 68 | 8*9 | 25 | 500 | 3500 |
| | 82 | 6.3*8 | 30 | 500 | 2150 |
| | 82 | 8*9 | 20 | 500 | 3800 |
| | 100 | 6.3*8 | 30 | 500 | 2200 |
| | 100 | 8*9 | 20 | 500 | 3900 |
| | 100 | 8*12 | 20 | 500 | 4200 |
| | 150 | 8*9 | 20 | 750 | 3900 |
| | 150 | 8*12 | 20 | 750 | 4200 |
| | 180 | 8*12 | 20 | 900 | 4200 |
| | 220 | 8*12 | 20 | 1100 | 4200 |
| | 270 | 10*12.5 | 18 | 1350 | 4800 |
| | 330 | 10*12.5 | 18 | 1650 | 4800 |
| | 470 | 10*12.5 | 18 | 2350 | 4800 |



H2 Series

- Low ESR, high ripple current, high voltage
- Load life of 2000 hours at 105°C
- RoHS Compliant

◆ 规格表 Specifications

| 项目 Items | 特性参数 Characteristics | | |
|---|---|-------------------------------|------------------|
| 使用温度范围 Category Temperature Range | -55 ~ +105°C | | |
| 额定工作电压范围 Rated Voltage Range | 35 ~ 100V | | |
| 静电容量允许偏差 Capacitance tolerance | ±20%(M) (at 20°C, 120Hz) | | |
| 漏电流 Leakage Current | 施加额定工作电压2分钟后读数, 小于或等于规格值 (at 20°C) I ≤ 0.1CV 或 299μA (取大值) Less than or equal to the specified value. After 2 minutes application of rated Voltage at 20°C | | |
| 损耗角正切值 tanδ Dissipation Factor | Rated voltage (V) | 35~100 | (at 20°C, 120Hz) |
| | tanδ (Max.) | 0.12 | |
| 温度特性 Low Temperature Characteristics (Max.Impedance Ratio) | Z(-25°C)/Z(+20°C) | ≤ 1.25 | (100KHz) |
| | Z(-55°C)/Z(+20°C) | ≤ 1.25 | |
| 耐久性 Endurance | 105°C施加额定工作电压2000小时, 恢复到20°C后, 产品性能应满足以下要求 The specifications listed below shall be satisfied when the capacitors are restored to 20°C after application of rated voltage for 2000 hours at 105°C. | | |
| | Appearance | No significant damage | |
| | Capacitance change | ≤ ±20% of the initial value | |
| | D.F.(tanδ) | ≤ 150% of the specified value | |
| | ESR | ≤ 150% of the specified value | |
| | Leakage current | ≤ The specified value | |
| 耐湿负荷特性 Damp Heat (Steady State) | 在60°C 温度, 湿度90%~95%RH的环境中, 施加额定电压1000小时后, 恢复到20°C后, 产品性能应满足以下要求 The specifications listed below shall be satisfied when the capacitors are restored to 20°C after application of rated voltage for 1000 hours at 60°C, 90%~ 95% RH. | | |
| | Appearance | No significant damage | |
| | Capacitance change | ≤ ±20% of the initial value | |
| | D.F.(tanδ) | ≤ 150% of the specified value | |
| | ESR | ≤ 150% of the specified value | |
| | Leakage current | ≤ The specified value | |
| 浪涌电压特性 (Surge Voltage) | 浪涌电压=额定电压× 1.15(V) Surge Voltage=Rated voltage × 1.15(V) 在105°C环境中, 按充电30秒; 放电5分30秒, 连续施加浪涌电压1000次(Rc=1kΩ), 待恢复后测试, 应满足以下要求 The capacitors shall be subjected to 1000 cycles each consisting of charge with the surge voltages specified at 105°C for 30 seconds through a protective resistor (Rc=1kΩ) and discharge for 5 minutes 30 seconds | | |
| | Appearance | No significant damage | |
| | Capacitance change | ≤ ±20% of the initial value | |
| | D.F.(tanδ) | ≤ 150% of the specified value | |
| | ESR | ≤ 150% of the specified value | |
| | Leakage current | ≤ The specified value | |

◆ 外形图 Dimensions (mm)

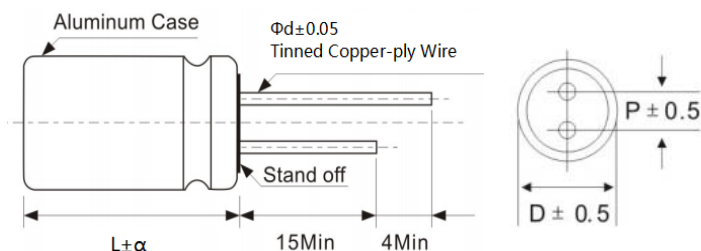

| | | | | |
|----|-----|-----|-----|-----|
| ΦD | 5 | 6.3 | 8 | 10 |
| P | 2.0 | 2.5 | 3.5 | 5.0 |
| Φd | 0.5 | 0.6 | 0.6 | 0.6 |

| | |
|---|------------------|
| α | (L < 16)1.0 |
| | (16 ≤ L < 22)1.5 |
| | (L ≥ 22)2.0 |



H2 Series

◆ 纹波电流修正系数 Rated Ripple Current Coefficient

| 频率 Frequency(Hz) | 120Hz \leq f < 1kHz | 1kHz \leq f < 10kHz | 10kHz \leq f < 100kHz | 100kHz \leq f < 500kHz |
|------------------|-----------------------|-----------------------|-------------------------|--------------------------|
| 系数 Coefficient | 0.05 | 0.30 | 0.70 | 1.00 |

◆ 尺寸与个技术参数一览表 Standard Ratings

| Rated voltage (V) | Rated capacitance (μ F) | Case size Φ D×L(mm) | ESR($m\Omega$) at 20°C, 100 KHz | Leakage Current (μ A) | Rated ripple current (mA rms/105°C/100kHz) |
|-------------------|------------------------------|--------------------------|-----------------------------------|----------------------------|--|
| 35 | 10 | 5*8 | 120 | 299 | 1100 |
| | 22 | 6.3*8 | 100 | 299 | 1350 |
| | 33 | 5*8 | 120 | 299 | 1100 |
| | 39 | 6.3*8 | 90 | 299 | 1350 |
| | 39 | 8*9 | 60 | 299 | 1800 |
| | 47 | 6.3*8 | 80 | 299 | 1350 |
| | 47 | 8*9 | 60 | 299 | 1800 |
| | 56 | 6.3*8 | 80 | 299 | 1350 |
| | 56 | 8*9 | 60 | 299 | 1800 |
| | 68 | 6.3*8 | 70 | 299 | 1500 |
| | 68 | 8*9 | 50 | 299 | 2000 |
| | 82 | 6.3*11 | 60 | 299 | 1800 |
| | 82 | 8*9 | 40 | 299 | 2000 |
| | 100 | 8*9 | 40 | 350 | 2000 |
| | 150 | 8*12 | 35 | 525 | 2500 |
| | 220 | 8*12 | 35 | 770 | 2500 |
| 330 | 10*12.5 | 30 | 1155 | 2900 | |
| 470 | 10*12.5 | 30 | 1645 | 2900 | |
| 50 | 10 | 5*8 | 120 | 299 | 550 |
| | 15 | 6.3*8 | 100 | 299 | 800 |
| | 22 | 6.3*8 | 100 | 299 | 850 |
| | 33 | 8*9 | 50 | 299 | 1300 |
| | 33 | 8*12 | 40 | 299 | 1500 |
| | 39 | 8*9 | 50 | 299 | 1300 |
| | 39 | 8*12 | 40 | 299 | 1500 |
| | 47 | 8*12 | 40 | 299 | 1500 |
| | 56 | 8*12 | 40 | 299 | 1500 |
| | 82 | 10*12.5 | 35 | 410 | 2100 |
| | 100 | 10*12.5 | 35 | 500 | 2100 |



H2 Series

◆ 尺寸与个技术参数一览表 Standard Ratings

| Rated voltage (V) | Rated capacitance (uF) | Case size $\Phi D \times L$ (mm) | ESR (m Ω) at 20°C, 100 KHz | Leakage Current (μA) | Rated ripple current (mA _{rms} /105°C/100kHz) |
|-------------------|------------------------|----------------------------------|------------------------------------|-----------------------------|--|
| 63 | 10 | 5*8 | 120 | 299 | 500 |
| | 15 | 6.3*8 | 100 | 299 | 750 |
| | 22 | 6.3*8 | 100 | 299 | 750 |
| | 33 | 8*9 | 55 | 299 | 1100 |
| | 39 | 8*9 | 55 | 299 | 1100 |
| | 47 | 8*12 | 45 | 299 | 1300 |
| | 56 | 8*12 | 45 | 353 | 1300 |
| | 82 | 10*12.5 | 38 | 517 | 1800 |
| | 100 | 10*12.5 | 38 | 630 | 1800 |
| 80 | 10 | 6.3*8 | 120 | 299 | 550 |
| | 15 | 6.3*8 | 120 | 299 | 550 |
| | 22 | 8*9 | 80 | 299 | 1100 |
| | 22 | 8*12 | 60 | 299 | 1300 |
| | 33 | 10*12.5 | 45 | 299 | 1700 |
| | 39 | 10*12.5 | 45 | 312 | 1700 |
| | 47 | 10*12.5 | 45 | 376 | 1800 |
| | 56 | 10*12.5 | 45 | 448 | 1800 |
| 100 | 10 | 8*9 | 90 | 299 | 850 |
| | 15 | 8*12 | 70 | 299 | 1190 |
| | 22 | 10*12.5 | 60 | 299 | 1550 |
| | 33 | 10*12.5 | 60 | 330 | 1550 |



H4 Series

- Low ESR, high ripple current, high voltage, high temperature
- Load life of 2000 hours at 125°C
- RoHS Compliant

◆ 规格表 Specifications

| 项目 Items | 特性参数 Characteristics | | |
|---|---|-------------------------------|------------------|
| 使用温度范围 Category Temperature Range | -55 ~ +125°C | | |
| 额定工作电压范围 Rated Voltage Range | 35 ~ 100V | | |
| 静电容量允许偏差 Capacitance tolerance | ±20%(M) (at 20°C, 120Hz) | | |
| 漏电流 Leakage Current | 施加额定工作电压2分钟后读数, 小于或等于规格值 (at 20°C) I ≤ 0.1CV 或 299μA (取大值) Less than or equal to the specified value. After 2 minutes application of rated Voltage at 20°C | | |
| 损耗角正切值 tanδ Dissipation Factor | Rated voltage (V) | 35~100 | (at 20°C, 120Hz) |
| | tanδ (Max.) | 0.12 | |
| 温度特性 Low Temperature Characteristics (Max.Impedance Ratio) | Z(-25°C)/Z(+20°C) | ≤ 1.25 | (100KHz) |
| | Z(-55°C)/Z(+20°C) | ≤ 1.25 | |
| 耐久性 Endurance | 125°C 施加额定工作电压2000小时, 恢复到20°C后, 产品性能应满足以下要求 The specifications listed below shall be satisfied when the capacitors are restored to 20°C after application of rated voltage for 2000 hours at 125°C. | | |
| | Appearance | No significant damage | |
| | Capacitance change | ≤ ±20% of the initial value | |
| | D.F.(tanδ) | ≤ 150% of the specified value | |
| | ESR | ≤ 150% of the specified value | |
| | Leakage current | ≤ The specified value | |
| 耐湿负荷特性 Damp Heat (Steady State) | 在60°C 温度, 湿度90%~95%RH的环境中, 施加额定电压1000小时后, 恢复到20°C后, 产品性能应满足以下要求 The specifications listed below shall be satisfied when the capacitors are restored to 20°C after application of rated voltage for 1000 hours at 60°C, 90%~95% RH. | | |
| | Appearance | No significant damage | |
| | Capacitance change | ≤ ±20% of the initial value | |
| | D.F.(tanδ) | ≤ 150% of the specified value | |
| | ESR | ≤ 150% of the specified value | |
| | Leakage current | ≤ The specified value | |
| 浪涌电压特性 (Surge Voltage) | 浪涌电压=额定电压× 1.15(V) Surge Voltage=Rated voltage × 1.15(V) 在125°C环境中, 按充电30秒; 放电5分30秒, 连续施加浪涌电压1000次(Rc=1kΩ), 待恢复后测试, 应满足以下要求 The capacitors shall be subjected to 1000 cycles each consisting of charge with the surge voltages specified at 125°C for 30 seconds through a protective resistor (Rc=1kΩ) and discharge for 5 minutes 30 seconds | | |
| | Appearance | No significant damage | |
| | Capacitance change | ≤ ±20% of the initial value | |
| | D.F.(tanδ) | ≤ 150% of the specified value | |
| | ESR | ≤ 150% of the specified value | |
| | Leakage current | ≤ The specified value | |

◆ 外形图 Dimensions (mm)

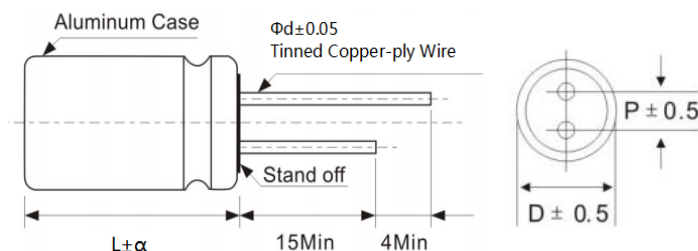

| | | | | |
|----|-----|-----|-----|-----|
| ΦD | 5 | 6.3 | 8 | 10 |
| P | 2.0 | 2.5 | 3.5 | 5.0 |
| Φd | 0.5 | 0.6 | 0.6 | 0.6 |

| | |
|---|-------------------|
| α | (L < 16) 1.0 |
| | (16 ≤ L < 22) 1.5 |
| | (L ≥ 22) 2.0 |



H4 Series

◆ 纹波电流修正系数 Rated Ripple Current Coefficient

| 频率 Frequency(Hz) | 120Hz \cong f < 1kHz | 1kHz \cong f < 10kHz | 10kHz \cong f < 100kHz | 100kHz \cong f < 500kHz |
|------------------|------------------------|------------------------|--------------------------|---------------------------|
| 系数 Coefficient | 0.05 | 0.30 | 0.70 | 1.00 |

◆ 尺寸与个技术参数一览表 Standard Ratings

| Rated voltage (V) | Rated capacitance (μ F) | Case size Φ D×L(mm) | ESR($m\Omega$) at 20°C, 100 KHz | Leakage Current (μ A) | Rated ripple current (mA _{rms} /125°C/100kHz) |
|-------------------|------------------------------|--------------------------|-----------------------------------|----------------------------|--|
| 35 | 10 | 5*8 | 120 | 299 | 630 |
| | 22 | 6.3*8 | 100 | 299 | 800 |
| | 33 | 6.3*8 | 100 | 299 | 630 |
| | 100 | 6.3*12 | 60 | 350 | 1040 |
| | 100 | 8*9 | 40 | 350 | 1150 |
| | 150 | 8*12 | 35 | 525 | 1440 |
| | 220 | 10*12.5 | 30 | 770 | 1700 |
| | 330 | 10*12.5 | 30 | 1155 | 1700 |
| 50 | 10 | 5*8 | 120 | 299 | 400 |
| | 22 | 6.3*8 | 100 | 299 | 500 |
| | 47 | 6.3*12 | 60 | 299 | 750 |
| | 47 | 8*12 | 40 | 299 | 860 |
| | 82 | 8*12 | 40 | 410 | 860 |
| | 100 | 10*12.5 | 35 | 500 | 1210 |
| | 220 | 10*12.5 | 35 | 1100 | 1210 |
| 63 | 10 | 6.3*8 | 100 | 299 | 400 |
| | 22 | 6.3*8 | 100 | 299 | 400 |
| | 47 | 8*9 | 55 | 299 | 630 |
| | 47 | 8*12 | 40 | 299 | 750 |
| | 100 | 10*12.5 | 38 | 630 | 1040 |
| 80 | 10 | 8*9 | 80 | 299 | 630 |
| | 22 | 8*12 | 60 | 299 | 750 |
| | 33 | 10*12.5 | 45 | 299 | 970 |
| | 47 | 10*12.5 | 45 | 299 | 1040 |
| | 56 | 10*12.5 | 45 | 448 | 1040 |
| 100 | 10 | 8*9 | 90 | 299 | 550 |
| | 15 | 8*12 | 70 | 299 | 680 |
| | 22 | 10*12.5 | 60 | 299 | 900 |
| | 33 | 10*12.5 | 60 | 330 | 900 |



H5 Series

- Low ESR, high ripple current, high voltage, long life
- Load life of 5000 hours at 105°C
- RoHS Compliant

◆ 规格表 Specifications

| 项目 Items | 特性参数 Characteristics | |
|---|---|-------------------------------|
| 使用温度范围 Category Temperature Range | -55 ~ +105°C | |
| 额定工作电压范围 Rated Voltage Range | 35 ~ 100V | |
| 静电容量允许偏差 Capacitance tolerance | ±20%(M) (at 20°C, 120Hz) | |
| 漏电流 Leakage Current | 施加额定工作电压2分钟后读数, 小于或等于规格值 (at 20°C) I ≤ 0.1CV 或 299μA (取大值) Less than or equal to the specified value. After 2 minutes application of rated Voltage at 20°C | |
| 损耗角正切值 tanδ Dissipation Factor | Rated voltage (V) | 35~100 |
| | tanδ (Max.) | 0.12 |
| 温度特性 Low Temperature Characteristics (Max.Impedance Ratio) | Z(-25°C)/Z(+20°C) | ≤ 1.25 |
| | Z(-55°C)/Z(+20°C) | ≤ 1.25 |
| 耐久性 Endurance | 105°C施加额定工作电压5000小时, 恢复到20°C后, 产品性能应满足以下要求 The specifications listed below shall be satisfied when the capacitors are restored to 20°C after application of rated voltage for 5000 hours at 105°C. | |
| | Appearance | No significant damage |
| | Capacitance change | ≤ ±20% of the initial value |
| | D.F.(tanδ) | ≤ 150% of the specified value |
| | ESR | ≤ 150% of the specified value |
| | Leakage current | ≤ The specified value |
| 耐湿负荷特性 Damp Heat (Steady State) | 在60°C 温度, 湿度90%~95%RH的环境中, 施加额定电压1000小时后, 恢复到20°C后, 产品性能应满足以下要求 The specifications listed below shall be satisfied when the capacitors are restored to 20°C after application of rated voltage for 1000 hours at 60°C, 90%~ 95% RH. | |
| | Appearance | No significant damage |
| | Capacitance change | ≤ ±20% of the initial value |
| | D.F.(tanδ) | ≤ 150% of the specified value |
| | ESR | ≤ 150% of the specified value |
| | Leakage current | ≤ The specified value |
| 浪涌电压特性 (Surge Voltage) | 浪涌电压=额定电压× 1.15(V) Surge Voltage=Rated voltage × 1.15(V) 在105°C环境中, 按充电30秒; 放电5分30秒, 连续施加浪涌电压1000次(Rc=1kΩ), 待恢复后测试, 应满足以下要求 The capacitors shall be subjected to 1000 cycles each consisting of charge with the surge voltages specified at 105°C for 30 seconds through a protective resistor (Rc=1kΩ) and discharge for 5 minutes 30 seconds | |
| | Appearance | No significant damage |
| | Capacitance change | ≤ ±20% of the initial value |
| | D.F.(tanδ) | ≤ 150% of the specified value |
| | ESR | ≤ 150% of the specified value |
| | Leakage current | ≤ The specified value |

◆ 外形图 Dimensions (mm)

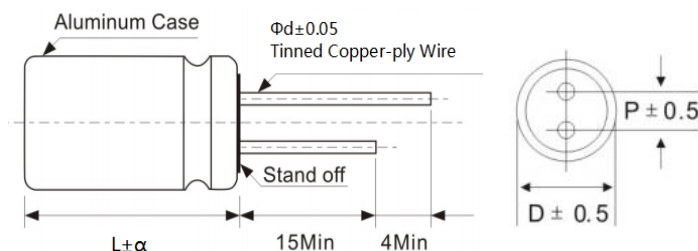

| | | | | |
|----|-----|-----|-----|-----|
| ΦD | 5 | 6.3 | 8 | 10 |
| P | 2.0 | 2.5 | 3.5 | 5.0 |
| Φd | 0.5 | 0.6 | 0.6 | 0.6 |

| | |
|---|-------------------|
| α | (L < 16) 1.0 |
| | (16 ≤ L < 22) 1.5 |
| | (L ≥ 22) 2.0 |



H5 Series

◆ 纹波电流修正系数 Rated Ripple Current Coefficient

| 频率 Frequency(Hz) | 120Hz \cong f < 1kHz | 1kHz \cong f < 10kHz | 10kHz \cong f < 100kHz | 100kHz \cong f < 500kHz |
|------------------|------------------------|------------------------|--------------------------|---------------------------|
| 系数 Coefficient | 0.05 | 0.30 | 0.70 | 1.00 |

◆ 尺寸与个技术参数一览表 Standard Ratings

| Rated voltage (V) | Rated capacitance (μ F) | Case size Φ D×L(mm) | ESR($m\Omega$) at 20°C, 100 KHz | Leakage Current (μ A) | Rated ripple current (mA _{rms} /105°C/100kHz) |
|-------------------|------------------------------|--------------------------|-----------------------------------|----------------------------|--|
| 35 | 10 | 5*8 | 120 | 299 | 1100 |
| | 22 | 6.3*8 | 100 | 299 | 1350 |
| | 33 | 5*8 | 120 | 299 | 1100 |
| | 39 | 6.3*8 | 90 | 299 | 1350 |
| | 39 | 8*9 | 60 | 299 | 1800 |
| | 47 | 6.3*8 | 80 | 299 | 1350 |
| | 47 | 8*9 | 60 | 299 | 1800 |
| | 56 | 6.3*8 | 80 | 299 | 1350 |
| | 56 | 8*9 | 60 | 299 | 1800 |
| | 68 | 6.3*8 | 70 | 299 | 1500 |
| | 68 | 8*9 | 50 | 299 | 2000 |
| | 82 | 6.3*11 | 60 | 299 | 1800 |
| | 82 | 8*9 | 40 | 299 | 2000 |
| | 100 | 8*9 | 40 | 350 | 2000 |
| | 150 | 8*12 | 35 | 525 | 2500 |
| | 220 | 10*12.5 | 30 | 770 | 2900 |
| 330 | 10*12.5 | 30 | 1155 | 2900 | |
| 50 | 10 | 5*8 | 120 | 299 | 550 |
| | 15 | 6.3*8 | 100 | 299 | 800 |
| | 22 | 6.3*8 | 100 | 299 | 850 |
| | 33 | 8*9 | 50 | 299 | 1300 |
| | 33 | 8*12 | 40 | 299 | 1500 |
| | 39 | 8*9 | 50 | 299 | 1300 |
| | 39 | 8*12 | 40 | 299 | 1500 |
| | 47 | 8*12 | 40 | 299 | 1500 |
| | 56 | 8*12 | 40 | 299 | 1500 |
| | 82 | 10*12.5 | 35 | 410 | 2100 |
| | 100 | 10*12.5 | 35 | 500 | 2100 |



H5 Series

◆ 尺寸与技术参数一览表 Standard Ratings

| Rated voltage (V) | Rated capacitance (uF) | Case size $\Phi D \times L$ (mm) | ESR ($m\Omega$) at 20°C, 100 KHz | Leakage Current (μA) | Rated ripple current (mA _{rms} /105°C/100kHz) |
|-------------------|------------------------|----------------------------------|---------------------------------------|-----------------------------|--|
| 63 | 10 | 5*8 | 120 | 299 | 500 |
| | 15 | 6.3*8 | 100 | 299 | 750 |
| | 22 | 6.3*8 | 100 | 299 | 750 |
| | 33 | 8*9 | 55 | 299 | 1100 |
| | 39 | 8*9 | 55 | 299 | 1100 |
| | 47 | 8*12 | 45 | 299 | 1300 |
| | 56 | 8*12 | 45 | 353 | 1300 |
| | 82 | 10*12.5 | 38 | 517 | 1800 |
| | 100 | 10*12.5 | 38 | 630 | 1800 |
| 80 | 10 | 6.3*8 | 120 | 299 | 550 |
| | 15 | 6.3*8 | 120 | 299 | 550 |
| | 22 | 8*9 | 80 | 299 | 1100 |
| | 22 | 8*12 | 60 | 299 | 1300 |
| | 33 | 10*12.5 | 45 | 299 | 1700 |
| | 39 | 10*12.5 | 45 | 312 | 1700 |
| | 47 | 10*12.5 | 45 | 376 | 1800 |
| | 56 | 10*12.5 | 45 | 448 | 1800 |
| 100 | 10 | 8*9 | 90 | 299 | 850 |
| | 15 | 8*12 | 70 | 299 | 1190 |
| | 22 | 10*12.5 | 60 | 299 | 1550 |
| | 33 | 10*12.5 | 60 | 330 | 1550 |



M1 Series

- Super low ESR, High ripple, miniaturized
- SMD type: lead free reflow soldering condition at 260°C peak correspondence
- RoHS Compliant

◆ 规格表 Specifications

| 项目 Items | 特性参数 Characteristics | | |
|--|---|-------------------------------|---------------------------------|
| 使用温度范围 Category Temperature Range | -55 ~ +105°C | | |
| 额定工作电压范围 Rated Voltage Range | 2.5 ~ 100V | | |
| 静电容量允许偏差 Capacitance tolerance | ±20%(M) (at 20°C, 120Hz) | | |
| 漏电流 Leakage Current | 施加额定工作电压2分钟后读数, 小于或等于规格值 (at 20°C) Less than or equal to the specified value. After 2 minutes application of rated Voltage at 20°C | | 2.5~25V |
| | | | 35~100V I≤0.1CV 或 299µA(取大值) |
| 损耗角正切值tanδ Dissipation Factor | Rated voltage (V) | 2.5~6.3 | 10~100 |
| | tanδ (Max.) | 0.08 | 0.12 |
| 温度特性 Low Temperature Characteristics (Max.Impedance Ratio) | Z(-25°C)/Z(+20°C) | ≤ 1.25 | |
| | Z(-55°C)/Z(+20°C) | ≤ 1.25 | |
| 耐久性 Endurance | 105°C施加额定工作电压2000小时, 恢复到20°C后, 产品性能应满足以下要求 The specifications listed below shall be satisfied when the capacitors are restored to 20°C after application of rated voltage for 2000 hours at 105°C. | | |
| | Appearance | No significant damage | |
| | Capacitance change | ≤ ±20% of the initial value | |
| | D.F.(tanδ) | ≤ 150% of the specified value | |
| | ESR | ≤ 150% of the specified value | |
| | Leakage current | ≤ The specified value | |
| 耐湿负荷特性 Damp Heat (Steady State) | 在60°C 温度, 湿度90%~95%RH的环境中, 施加额定电压1000小时后, 恢复到20°C后, 产品性能应满足以下要求 The specifications listed below shall be satisfied when the capacitors are restored to 20°C after application of rated voltage for 1000 hours at 60°C, 90%~ 95% RH. | | |
| | Appearance | No significant damage | |
| | Capacitance change | ≤ ±20% of the initial value | |
| | D.F.(tanδ) | ≤ 150% of the specified value | |
| | ESR | ≤ 150% of the specified value | |
| | Leakage current | ≤ The specified value | |
| 浪涌电压特性 (Surge Voltage) | 浪涌电压=额定电压× 1.15(V) Surge Voltage=Rated voltage × 1.15(V) 在105°C环境中, 按充电30秒; 放电5分30秒, 连续施加浪涌电压1000次(Rc=1kΩ), 待恢复测试, 应满足以下要求 The capacitors shall be subjected to 1000 cycles each consisting of charge with the surge voltages specified at 105°C for 30 seconds through a protective resistor (Rc=1kΩ) and discharge for 5 minutes 30 seconds. | | |
| | Appearance | No significant damage | |
| | Capacitance change | ≤ ±20% of the initial value | |
| | D.F.(tanδ) | ≤ 150% of the specified value | |
| | ESR | ≤ 150% of the specified value | |
| | Leakage current | ≤ The specified value | |
| 焊接耐热性 Resistance to soldering heat | 按回流焊试验后, 应满足以下要求 Measurement for solder temperature profile shall be made at the capacitor top and the terminal. | | |
| | Capacitance change | ≤ ±10% of the initial value | |
| | D.F.(tanδ) | ≤ 130% of the specified value | |
| | ESR | ≤ 130% of the specified value | |
| | Leakage current | ≤ The specified value | |

◆ 外形图 Dimensions (mm)

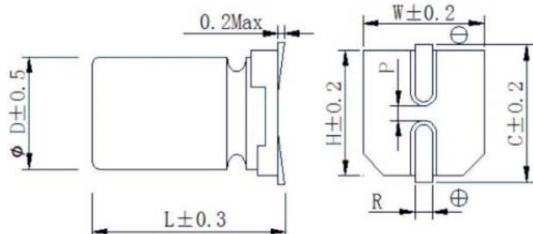

| ΦD | W | H | C | R | P |
|-----|------|------|------|---------|-----|
| 5 | 5.3 | 5.3 | 5.9 | 0.5~0.8 | 1.4 |
| 6.3 | 6.5 | 6.5 | 7.2 | 0.5~0.8 | 2.2 |
| 8 | 8.3 | 8.3 | 9.0 | 0.7~1.1 | 3.1 |
| 10 | 10.3 | 10.3 | 11.0 | 0.7~1.1 | 4.5 |



M1 Series

◆ 纹波电流修正系数 Rated Ripple Current Coefficient

| 频率 Frequency(Hz) | 120Hz \cong f < 1kHz | 1kHz \cong f < 10kHz | 10kHz \cong f < 100kHz | 100kHz \cong f < 500kHz |
|------------------|------------------------|------------------------|--------------------------|---------------------------|
| 系数 Coefficient | 0.05 | 0.30 | 0.70 | 1.00 |

◆ 尺寸与个技术参数一览表 Standard Ratings

| Rated voltage (V) | Rated capacitance (uF) | Case size Φ D×L(mm) | ESR(m Ω) at 20°C, 100 KHz | Leakage Current (μ A) | Rated ripple current (mArms/105°C/100kHz) |
|-------------------|------------------------|--------------------------|-----------------------------------|----------------------------|---|
| 2.5 | 470 | 6.3*9 | 15 | 500 | 4500 |
| | 470 | 8*9.8 | 15 | 500 | 4800 |
| | 560 | 6.3*9 | 15 | 500 | 4500 |
| | 560 | 8*9.8 | 15 | 500 | 4800 |
| | 680 | 8*12.6 | 12 | 500 | 5100 |
| | 820 | 8*12.6 | 12 | 500 | 5100 |
| 4 | 560 | 8*9.8 | 15 | 500 | 4500 |
| | 680 | 8*12.6 | 12 | 544 | 4700 |
| | 820 | 10*12.6 | 12 | 656 | 5500 |
| | 1000 | 10*12.6 | 10 | 800 | 5500 |
| | 1200 | 10*12.6 | 10 | 960 | 5500 |
| 6.3 | 220 | 6.3*9 | 18 | 500 | 3900 |
| | 270 | 6.3*9 | 18 | 500 | 4100 |
| | 330 | 6.3*9 | 18 | 500 | 4100 |
| | 470 | 8*9.8 | 15 | 592 | 4500 |
| | 560 | 8*9.8 | 15 | 592 | 4500 |
| | 680 | 8*12.6 | 12 | 857 | 4700 |
| | 820 | 10*12.6 | 10 | 1033 | 5500 |
| | 1000 | 10*12.6 | 10 | 1260 | 5500 |
| | 1500 | 10*12.6 | 10 | 1890 | 5500 |
| 10 | 220 | 6.3*9 | 22 | 500 | 3500 |
| | 270 | 6.3*9 | 22 | 540 | 3500 |
| | 330 | 8*9.8 | 18 | 660 | 4100 |
| | 470 | 8*9.8 | 18 | 940 | 4230 |
| | 560 | 8*9.8 | 18 | 1120 | 4230 |
| | 680 | 8*12.6 | 15 | 1360 | 4500 |
| | 820 | 10*12.6 | 12 | 1640 | 5300 |
| | 1000 | 10*12.6 | 12 | 2000 | 5300 |
| 16 | 47 | 6.3*9 | 25 | 500 | 2690 |
| | 68 | 6.3*9 | 25 | 500 | 2690 |
| | 82 | 6.3*9 | 25 | 500 | 2690 |
| | 100 | 6.3*9 | 25 | 500 | 2690 |
| | 220 | 6.3*9 | 25 | 704 | 2690 |



M1 Series

◆ 尺寸与技术参数一览表 Standard Ratings

| Rated voltage (V) | Rated capacitance (uF) | Case size $\Phi D \times L$ (mm) | ESR (m Ω) at 20°C, 100 KHz | Leakage Current (μA) | Rated ripple current (mA _{rms} /105°C/100kHz) |
|-------------------|------------------------|----------------------------------|------------------------------------|-----------------------------|--|
| 16 | 220 | 8*9.8 | 20 | 704 | 3200 |
| | 220 | 8*12.6 | 16 | 704 | 4100 |
| | 270 | 8*9.8 | 20 | 864 | 3200 |
| | 330 | 6.3*9 | 22 | 1056 | 2690 |
| | 330 | 8*9.8 | 20 | 1056 | 3200 |
| | 330 | 8*12.6 | 16 | 1056 | 4100 |
| | 470 | 8*12.6 | 16 | 1504 | 4100 |
| | 470 | 10*12.6 | 14 | 1504 | 5100 |
| | 560 | 8*12.6 | 16 | 1792 | 4100 |
| | 680 | 10*12.6 | 14 | 2176 | 5100 |
| | 820 | 10*12.6 | 14 | 2624 | 5100 |
| | 1000 | 10*12.6 | 14 | 3200 | 5100 |
| | 25 | 22 | 6.3*9 | 30 | 500 |
| 33 | | 6.3*9 | 30 | 500 | 2100 |
| 47 | | 6.3*9 | 30 | 500 | 2100 |
| 47 | | 8*9.8 | 25 | 500 | 2690 |
| 68 | | 6.3*9 | 30 | 500 | 2100 |
| 82 | | 6.3*9 | 30 | 500 | 2100 |
| 100 | | 6.3*9 | 30 | 500 | 2100 |
| 100 | | 8*9.8 | 25 | 500 | 2690 |
| 150 | | 8*9.8 | 25 | 750 | 2690 |
| 220 | | 8*12.6 | 25 | 1100 | 2900 |
| 220 | | 10*12.6 | 20 | 1100 | 3500 |
| 270 | | 8*12.6 | 25 | 1350 | 2900 |
| 330 | | 10*12.6 | 20 | 1650 | 3500 |
| 470 | | 10*12.6 | 20 | 2350 | 3500 |
| 35 | | 10 | 6.3*9 | 90 | 299 |
| | 22 | 6.3*9 | 90 | 299 | 1410 |
| | 33 | 6.3*9 | 90 | 299 | 1410 |
| | 47 | 6.3*9 | 60 | 299 | 1410 |
| | 82 | 8*9.8 | 35 | 299 | 1900 |
| | 100 | 8*9.8 | 30 | 350 | 1900 |
| | 100 | 8*12.6 | 25 | 350 | 2690 |
| | 220 | 10*12.6 | 20 | 770 | 3100 |



M1 Series

◆ 尺寸与个技术参数一览表 Standard Ratings

| Rated voltage (V) | Rated capacitance (uF) | Case size $\Phi D \times L$ (mm) | ESR (m Ω) at 20°C, 100 KHz | Leakage Current (μ A) | Rated ripple current (mA _{rms} /105°C/100kHz) |
|-------------------|------------------------|----------------------------------|------------------------------------|----------------------------|--|
| 50 | 10 | 6.3*9 | 90 | 299 | 800 |
| | 22 | 6.3*9 | 90 | 299 | 850 |
| | 33 | 8*9.8 | 30 | 299 | 1300 |
| | 47 | 8*12.6 | 25 | 299 | 1500 |
| | 68 | 8*12.6 | 25 | 340 | 1500 |
| | 100 | 8*12.6 | 25 | 500 | 1500 |
| | 120 | 10*12.6 | 20 | 600 | 2100 |
| | 220 | 10*12.6 | 20 | 1100 | 2100 |
| 63 | 10 | 6.3*9 | 90 | 299 | 750 |
| | 22 | 8*9.8 | 35 | 299 | 1100 |
| | 33 | 8*9.8 | 35 | 299 | 1100 |
| | 33 | 8*12.6 | 30 | 299 | 1300 |
| | 47 | 8*12.6 | 30 | 299 | 1300 |
| | 68 | 8*12.6 | 30 | 428 | 1300 |
| | 82 | 10*12.6 | 25 | 517 | 1800 |
| | 100 | 10*12.6 | 25 | 630 | 1800 |
| 80 | 10 | 6.3*9 | 100 | 299 | 550 |
| | 22 | 8*9.8 | 50 | 299 | 1100 |
| | 22 | 8*12.6 | 40 | 299 | 1300 |
| | 33 | 8*12.6 | 40 | 299 | 1300 |
| | 47 | 10*12.6 | 35 | 376 | 1800 |
| 100 | 10 | 8*9.8 | 55 | 299 | 850 |
| | 15 | 8*12.6 | 45 | 299 | 1190 |
| | 22 | 10*12.6 | 40 | 299 | 1550 |
| | 33 | 10*12.6 | 40 | 330 | 1550 |



M2 Series

- Low ESR, High ripple, miniaturized
- SMD type: lead free reflow soldering condition at 260°C peak correspondence
- RoHS Compliant

规格表 Specifications

| 项目 Items | 特性参数 Characteristics | | |
|--|---|-------------------------------|---------------------------------|
| 使用温度范围 Category Temperature Range | -55 ~ +105°C | | |
| 额定工作电压范围 Rated Voltage Range | 2.5 ~ 100V | | |
| 静电容量允许偏差 Capacitance tolerance | ±20%(M) (at 20°C, 120Hz) | | |
| 漏电流 Leakage Current | 施加额定工作电压2分钟后读数, 小于或等于规格值 (at 20°C) Less than or equal to the specified value. After 2 minutes application of rated Voltage at 20°C | | 2.5~25V |
| | | | 35~100V I≤0.1CV 或 299µA(取大值) |
| 损耗角正切值tanδ Dissipation Factor | Rated voltage (V) | 2.5~6.3 | 10~100 |
| | tanδ (Max.) | 0.08 | 0.12 |
| 温度特性 Low Temperature Characteristics (Max.Impedance Ratio) | Z(-25°C)/Z(+20°C) | ≤ 1.25 | (100KHz) |
| | Z(-55°C)/Z(+20°C) | ≤ 1.25 | |
| 耐久性 Endurance | 105°C施加额定工作电压2000小时, 恢复到20°C后, 产品性能应满足以下要求 The specifications listed below shall be satisfied when the capacitors are restored to 20°C after application of rated voltage for 2000 hours at 105°C. | | |
| | Appearance | No significant damage | |
| | Capacitance change | ≤ ±20% of the initial value | |
| | D.F.(tanδ) | ≤ 150% of the specified value | |
| | ESR | ≤ 150% of the specified value | |
| | Leakage current | ≤ The specified value | |
| 耐湿负荷特性 Damp Heat (Steady State) | 在60°C 温度, 湿度90%~95%RH的环境中, 施加额定电压1000小时后, 恢复到20°C后, 产品性能应满足以下要求 The specifications listed below shall be satisfied when the capacitors are restored to 20°C after application of rated voltage for 1000 hours at 60°C, 90%~ 95% RH. | | |
| | Appearance | No significant damage | |
| | Capacitance change | ≤ ±20% of the initial value | |
| | D.F.(tanδ) | ≤ 150% of the specified value | |
| | ESR | ≤ 150% of the specified value | |
| | Leakage current | ≤ The specified value | |
| 浪涌电压特性 (Surge Voltage) | 浪涌电压=额定电压× 1.15(V) Surge Voltage=Rated voltage × 1.15(V) 在105°C环境中, 按充电30秒; 放电5分30秒, 连续施加浪涌电压1000次(Rc=1kΩ), 待恢复测试, 应满足以下要求 The capacitors shall be subjected to 1000 cycles each consisting of charge with the surge voltages specified at 105°C for 30 seconds through a protective resistor (Rc=1kΩ) and discharge for 5 minutes 30 seconds. | | |
| | Appearance | No significant damage | |
| | Capacitance change | ≤ ±20% of the initial value | |
| | D.F.(tanδ) | ≤ 150% of the specified value | |
| | ESR | ≤ 150% of the specified value | |
| | Leakage current | ≤ The specified value | |
| 焊接耐热性 Resistance to soldering heat | 按回流焊试验后, 应满足以下要求 Measurement for solder temperature profile shall be made at the capacitor top and the terminal. | | |
| | Capacitance change | ≤ ±10% of the initial value | |
| | D.F.(tanδ) | ≤ 130% of the specified value | |
| | ESR | ≤ 130% of the specified value | |
| | Leakage current | ≤ The specified value | |

外形图 Dimensions (mm)

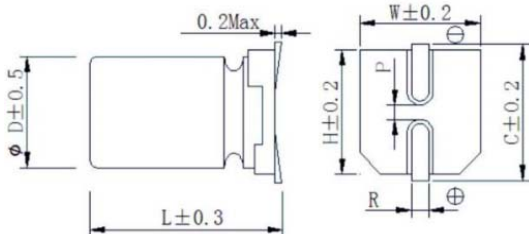

| ΦD | W | H | C | R | P |
|-----|------|------|------|---------|-----|
| 5 | 5.3 | 5.3 | 5.9 | 0.5~0.8 | 1.4 |
| 6.3 | 6.5 | 6.5 | 7.2 | 0.5~0.8 | 2.2 |
| 8 | 8.3 | 8.3 | 9.0 | 0.7~1.1 | 3.1 |
| 10 | 10.3 | 10.3 | 11.0 | 0.7~1.1 | 4.5 |



M2 Series

◆ 纹波电流修正系数 Rated Ripple Current Coefficient

| 频率 Frequency(Hz) | 120Hz \cong f < 1kHz | 1kHz \cong f < 10kHz | 10kHz \cong f < 100kHz | 100kHz \cong f < 500kHz |
|------------------|------------------------|------------------------|--------------------------|---------------------------|
| 系数 Coefficient | 0.05 | 0.30 | 0.70 | 1.00 |

◆ 尺寸与个技术参数一览表 Standard Ratings

| Rated voltage (V) | Rated capacitance (μ F) | Case size Φ D×L(mm) | ESR($m\Omega$) at 20°C, 100 KHz | Leakage Current (μ A) | Rated ripple current (mA _{rms} /105°C/100kHz) |
|-------------------|------------------------------|--------------------------|-----------------------------------|----------------------------|--|
| 2.5 | 470 | 6.3*9 | 30 | 500 | 4100 |
| | 470 | 8*9.8 | 30 | 500 | 4500 |
| | 560 | 6.3*9 | 30 | 500 | 4100 |
| | 560 | 8*9.8 | 30 | 500 | 4500 |
| | 680 | 8*12.6 | 25 | 500 | 4800 |
| | 820 | 8*12.6 | 25 | 500 | 4800 |
| 4 | 560 | 8*9.8 | 30 | 500 | 4250 |
| | 680 | 8*12.6 | 25 | 544 | 4700 |
| | 820 | 10*12.6 | 20 | 656 | 5100 |
| | 1000 | 10*12.6 | 20 | 800 | 5100 |
| | 1200 | 10*12.6 | 20 | 960 | 5100 |
| 6.3 | 220 | 6.3*9 | 35 | 500 | 3500 |
| | 270 | 6.3*9 | 35 | 500 | 3500 |
| | 330 | 6.3*9 | 35 | 500 | 3500 |
| | 470 | 8*9.8 | 35 | 592 | 3800 |
| | 560 | 8*9.8 | 35 | 706 | 3800 |
| | 680 | 8*12.6 | 25 | 857 | 4300 |
| | 820 | 10*12.6 | 25 | 1033 | 4800 |
| | 1000 | 10*12.6 | 25 | 1260 | 4800 |
| | 1500 | 10*12.6 | 25 | 1890 | 4800 |
| 10 | 220 | 6.3*9 | 35 | 500 | 2900 |
| | 270 | 6.3*9 | 35 | 540 | 2900 |
| | 330 | 8*9.8 | 35 | 660 | 3600 |
| | 470 | 8*9.8 | 35 | 940 | 3600 |
| | 560 | 8*9.8 | 35 | 1120 | 3600 |
| | 680 | 8*12.6 | 25 | 1360 | 4200 |
| | 820 | 10*12.6 | 25 | 1640 | 4500 |
| | 1000 | 10*12.6 | 25 | 2000 | 4500 |
| 16 | 47 | 6.3*9 | 50 | 500 | 2690 |
| | 68 | 6.3*9 | 40 | 500 | 2690 |
| | 82 | 6.3*9 | 40 | 500 | 2690 |
| | 100 | 6.3*9 | 40 | 500 | 2690 |
| | 220 | 6.3*9 | 40 | 704 | 2690 |



M2 Series

◆ 尺寸与个技术参数一览表 Standard Ratings

| Rated voltage (V) | Rated capacitance (uF) | Case size $\Phi D \times L$ (mm) | ESR (m Ω) at 20°C, 100 KHz | Leakage Current (μA) | Rated ripple current (mA _{rms} /105°C/100kHz) |
|-------------------|------------------------|----------------------------------|------------------------------------|-----------------------------|--|
| 16 | 220 | 8*9.8 | 40 | 704 | 2900 |
| | 220 | 8*12.6 | 30 | 704 | 3500 |
| | 270 | 8*9.8 | 40 | 864 | 2900 |
| | 330 | 6.3*9 | 40 | 1056 | 2690 |
| | 330 | 8*9.8 | 40 | 1056 | 2900 |
| | 330 | 8*12.6 | 30 | 1056 | 3500 |
| | 470 | 8*12.6 | 30 | 1504 | 3500 |
| | 470 | 10*12.6 | 30 | 1504 | 4100 |
| | 560 | 8*12.6 | 30 | 1792 | 3500 |
| | 680 | 10*12.6 | 30 | 2176 | 4100 |
| | 820 | 10*12.6 | 30 | 2624 | 4100 |
| | 1000 | 10*12.6 | 30 | 3200 | 4100 |
| | 25 | 22 | 6.3*9 | 60 | 500 |
| 33 | | 6.3*9 | 60 | 500 | 2100 |
| 47 | | 6.3*9 | 60 | 500 | 2100 |
| 47 | | 8*9.8 | 50 | 500 | 2690 |
| 68 | | 6.3*9 | 50 | 500 | 2100 |
| 82 | | 6.3*9 | 50 | 500 | 2100 |
| 100 | | 6.3*9 | 50 | 500 | 2100 |
| 100 | | 8*9.8 | 50 | 500 | 2690 |
| 150 | | 8*9.8 | 50 | 750 | 2690 |
| 220 | | 8*12.6 | 50 | 1100 | 2900 |
| 220 | | 10*12.6 | 45 | 1100 | 3500 |
| 270 | | 8*12.6 | 50 | 1350 | 2900 |
| 330 | | 10*12.6 | 45 | 1650 | 3500 |
| 470 | | 10*12.6 | 45 | 2350 | 3500 |
| 35 | | 10 | 6.3*9 | 100 | 299 |
| | 22 | 6.3*9 | 100 | 299 | 1410 |
| | 33 | 6.3*9 | 100 | 299 | 1410 |
| | 47 | 6.3*9 | 80 | 299 | 1410 |
| | 82 | 8*9.8 | 55 | 299 | 1900 |
| | 100 | 8*9.8 | 55 | 350 | 1900 |
| | 100 | 8*12.6 | 55 | 350 | 2690 |
| | 220 | 10*12.6 | 50 | 770 | 3100 |



M2 Series

◆ 尺寸与个技术参数一览表 Standard Ratings

| Rated voltage (V) | Rated capacitance (uF) | Case size $\Phi D \times L$ (mm) | ESR (m Ω) at 20°C, 100 KHz | Leakage Current (μA) | Rated ripple current (mA _{rms} /105°C/100kHz) |
|-------------------|------------------------|----------------------------------|------------------------------------|-----------------------------|--|
| 50 | 10 | 6.3*9 | 100 | 299 | 800 |
| | 22 | 6.3*9 | 100 | 299 | 850 |
| | 33 | 8*9.8 | 60 | 299 | 1300 |
| | 47 | 8*12.6 | 60 | 299 | 1500 |
| | 68 | 8*12.6 | 60 | 340 | 1500 |
| | 100 | 8*12.6 | 60 | 500 | 1500 |
| | 120 | 10*12.6 | 55 | 600 | 2100 |
| | 220 | 10*12.6 | 55 | 1100 | 2100 |
| 63 | 10 | 6.3*9 | 110 | 299 | 750 |
| | 22 | 8*9.8 | 60 | 299 | 1100 |
| | 33 | 8*9.8 | 60 | 299 | 1100 |
| | 33 | 8*12.6 | 60 | 299 | 1300 |
| | 47 | 8*12.6 | 60 | 299 | 1300 |
| | 68 | 8*12.6 | 60 | 428 | 1300 |
| | 82 | 10*12.6 | 55 | 517 | 1800 |
| | 100 | 10*12.6 | 55 | 630 | 1800 |
| 80 | 10 | 6.3*9 | 120 | 299 | 550 |
| | 22 | 8*9.8 | 80 | 299 | 1100 |
| | 22 | 8*12.6 | 70 | 299 | 1300 |
| | 33 | 8*12.6 | 70 | 299 | 1300 |
| | 47 | 10*12.6 | 60 | 376 | 1800 |
| 100 | 10 | 8*9.8 | 90 | 299 | 850 |
| | 15 | 8*12.6 | 70 | 299 | 1190 |
| | 22 | 10*12.6 | 60 | 299 | 1550 |
| | 33 | 10*12.6 | 60 | 330 | 1550 |



M5 Series

- Low ESR, High ripple, miniaturized
- SMD type: lead free reflow soldering condition at 260°C peak correspondence
- RoHS Compliant

规格表 Specifications

| 项目 Items | 特性参数 Characteristics | | |
|--|---|-------------------------------|--|
| 使用温度范围 Category Temperature Range | -55 ~ +105°C | | |
| 额定工作电压范围 Rated Voltage Range | 10 ~ 50V | | |
| 静电容量允许偏差 Capacitance tolerance | ±20%(M) (at 20°C, 120Hz) | | |
| 漏电流 Leakage Current | 施加额定工作电压2分钟后读数, 小于或等于规格值 (at 20°C) Less than or equal to the specified value. After 2 minutes application of rated Voltage at 20°C | | 2.5~25V 35~100V |
| | | | I≤0.2CV 或500μA(取大值) I≤0.1CV 或299μA(取大值) |
| 损耗角正切值tanδ Dissipation Factor | Rated voltage (V) | 2.5~6.3 | 10~100 |
| | tanδ (Max.) | 0.08 | 0.12 |
| 温度特性 Low Temperature Characteristics (Max.Impedance Ratio) | Z(-25°C)/Z(+20°C) | ≤ 1.25 | (100KHz) |
| | Z(-55°C)/Z(+20°C) | ≤ 1.25 | |
| 耐久性 Endurance | 105°C施加额定工作电压5000小时, 恢复到20°C后, 产品性能应满足以下要求 The specifications listed below shall be satisfied when the capacitors are restored to 20°C after application of rated voltage for 5000 hours at 105°C. | | |
| | Appearance | No significant damage | |
| | Capacitance change | ≤ ±20% of the initial value | |
| | D.F.(tanδ) | ≤ 150% of the specified value | |
| | ESR | ≤ 150% of the specified value | |
| | Leakage current | ≤ The specified value | |
| 耐湿负荷特性 Damp Heat (Steady State) | 在60°C 温度, 湿度90%~95%RH的环境中, 施加额定电压1000小时后, 恢复到20°C后, 产品性能应满足以下要求 The specifications listed below shall be satisfied when the capacitors are restored to 20°C after application of rated voltage for 1000 hours at 60°C, 90%~ 95% RH. | | |
| | Appearance | No significant damage | |
| | Capacitance change | ≤ ±20% of the initial value | |
| | D.F.(tanδ) | ≤ 150% of the specified value | |
| | ESR | ≤ 150% of the specified value | |
| | Leakage current | ≤ The specified value | |
| 浪涌电压特性 (Surge Voltage) | 浪涌电压=额定电压× 1.15(V) Surge Voltage=Rated voltage × 1.15(V) 在105°C环境中, 按充电30秒; 放电5分30秒, 连续施加浪涌电压1000次(Rc=1kΩ), 待恢复测试, 应满足以下要求 The capacitors shall be subjected to 1000 cycles each consisting of charge with the surge voltages specified at 105°C for 30 seconds through a protective resistor (Rc=1kΩ) and discharge for 5 minutes 30 seconds. | | |
| | Appearance | No significant damage | |
| | Capacitance change | ≤ ±20% of the initial value | |
| | D.F.(tanδ) | ≤ 150% of the specified value | |
| | ESR | ≤ 150% of the specified value | |
| | Leakage current | ≤ The specified value | |
| 焊接耐热性 Resistance to soldering heat | 按回流焊试验后, 应满足以下要求 Measurement for solder temperature profile shall be made at the capacitor top and the terminal. | | |
| | Capacitance change | ≤ ±10% of the initial value | |
| | D.F.(tanδ) | ≤ 130% of the specified value | |
| | ESR | ≤ 130% of the specified value | |
| | Leakage current | ≤ The specified value | |

外形图 Dimensions (mm)

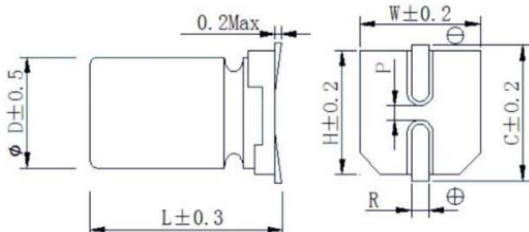

| ΦD | W | H | C | R | P |
|-----|------|------|------|---------|-----|
| 5 | 5.3 | 5.3 | 5.9 | 0.5~0.8 | 1.4 |
| 6.3 | 6.5 | 6.5 | 7.2 | 0.5~0.8 | 2.2 |
| 8 | 8.3 | 8.3 | 9.0 | 0.7~1.1 | 3.1 |
| 10 | 10.3 | 10.3 | 11.0 | 0.7~1.1 | 4.5 |



M5 Series

◆ 纹波电流修正系数 Rated Ripple Current Coefficient

| 频率 Frequency(Hz) | 120Hz \cong f < 1kHz | 1kHz \cong f < 10kHz | 10kHz \cong f < 100kHz | 100kHz \cong f < 500kHz |
|------------------|------------------------|------------------------|--------------------------|---------------------------|
| 系数 Coefficient | 0.05 | 0.30 | 0.70 | 1.00 |

◆ 尺寸与个技术参数一览表 Standard Ratings

| Rated voltage (V) | Rated capacitance (μ F) | Case size Φ D×L(mm) | ESR($m\Omega$) at 20°C, 100 KHz | Leakage Current (μ A) | Rated ripple current (mA _{rms} /105°C/100kHz) |
|-------------------|------------------------------|--------------------------|-----------------------------------|----------------------------|--|
| 2.5 | 470 | 6.3*9 | 30 | 500 | 4100 |
| | 470 | 8*9.8 | 30 | 500 | 4500 |
| | 560 | 6.3*9 | 30 | 500 | 4100 |
| | 560 | 8*9.8 | 30 | 500 | 4500 |
| | 680 | 8*12.6 | 25 | 500 | 4800 |
| | 820 | 8*12.6 | 25 | 500 | 4800 |
| 4 | 560 | 8*9.8 | 30 | 500 | 4250 |
| | 680 | 8*12.6 | 25 | 544 | 4700 |
| | 820 | 10*12.6 | 20 | 656 | 5100 |
| | 1000 | 10*12.6 | 20 | 800 | 5100 |
| | 1200 | 10*12.6 | 20 | 960 | 5100 |
| 6.3 | 220 | 6.3*9 | 35 | 500 | 3500 |
| | 270 | 6.3*9 | 35 | 500 | 3500 |
| | 330 | 6.3*9 | 35 | 500 | 3500 |
| | 470 | 8*9.8 | 35 | 592 | 3800 |
| | 560 | 8*9.8 | 35 | 706 | 3800 |
| | 680 | 8*12.6 | 25 | 857 | 4300 |
| | 820 | 10*12.6 | 25 | 1033 | 4800 |
| | 1000 | 10*12.6 | 25 | 1260 | 4800 |
| | 1500 | 10*12.6 | 25 | 1890 | 4800 |
| 10 | 220 | 6.3*9 | 35 | 500 | 2900 |
| | 270 | 6.3*9 | 35 | 540 | 2900 |
| | 330 | 8*9.8 | 35 | 660 | 3600 |
| | 470 | 8*9.8 | 35 | 940 | 3600 |
| | 560 | 8*9.8 | 35 | 1120 | 3600 |
| | 680 | 8*12.6 | 25 | 1360 | 4200 |
| | 820 | 10*12.6 | 25 | 1640 | 4500 |
| | 1000 | 10*12.6 | 25 | 2000 | 4500 |
| 16 | 47 | 6.3*9 | 50 | 500 | 2690 |
| | 68 | 6.3*9 | 40 | 500 | 2690 |
| | 82 | 6.3*9 | 40 | 500 | 2690 |
| | 100 | 6.3*9 | 40 | 500 | 2690 |
| | 220 | 6.3*9 | 40 | 704 | 2690 |



M5 Series

◆ 尺寸与个技术参数一览表 Standard Ratings

| Rated voltage (V) | Rated capacitance (uF) | Case size $\Phi D \times L$ (mm) | ESR (m Ω) at 20°C, 100 KHz | Leakage Current (μA) | Rated ripple current (mA _{rms} /105°C/100kHz) |
|-------------------|------------------------|----------------------------------|------------------------------------|-----------------------------|--|
| 16 | 220 | 8*9.8 | 40 | 704 | 2900 |
| | 220 | 8*12.6 | 30 | 704 | 3500 |
| | 270 | 8*9.8 | 40 | 864 | 2900 |
| | 330 | 6.3*9 | 40 | 1056 | 2690 |
| | 330 | 8*9.8 | 40 | 1056 | 2900 |
| | 330 | 8*12.6 | 30 | 1056 | 3500 |
| | 470 | 8*12.6 | 30 | 1504 | 3500 |
| | 470 | 10*12.6 | 30 | 1504 | 4100 |
| | 560 | 8*12.6 | 30 | 1792 | 3500 |
| | 680 | 10*12.6 | 30 | 2176 | 4100 |
| | 820 | 10*12.6 | 30 | 2624 | 4100 |
| | 1000 | 10*12.6 | 30 | 3200 | 4100 |
| | 25 | 22 | 6.3*9 | 60 | 500 |
| 33 | | 6.3*9 | 60 | 500 | 2100 |
| 47 | | 6.3*9 | 60 | 500 | 2100 |
| 47 | | 8*9.8 | 50 | 500 | 2690 |
| 68 | | 6.3*9 | 50 | 500 | 2100 |
| 82 | | 6.3*9 | 50 | 500 | 2100 |
| 100 | | 6.3*9 | 50 | 500 | 2100 |
| 100 | | 8*9.8 | 50 | 500 | 2690 |
| 150 | | 8*9.8 | 50 | 750 | 2690 |
| 220 | | 8*12.6 | 50 | 1100 | 2900 |
| 220 | | 10*12.6 | 45 | 1100 | 3500 |
| 270 | | 8*12.6 | 50 | 1350 | 2900 |
| 330 | | 10*12.6 | 45 | 1650 | 3500 |
| 470 | | 10*12.6 | 45 | 2350 | 3500 |
| 35 | | 10 | 6.3*9 | 100 | 299 |
| | 22 | 6.3*9 | 100 | 299 | 1410 |
| | 33 | 6.3*9 | 100 | 299 | 1410 |
| | 47 | 6.3*9 | 80 | 299 | 1410 |
| | 82 | 8*9.8 | 55 | 299 | 1900 |
| | 100 | 8*9.8 | 55 | 350 | 1900 |
| | 100 | 8*12.6 | 55 | 350 | 2690 |
| | 220 | 10*12.6 | 50 | 770 | 3100 |



M5 Series

◆ 尺寸与个技术参数一览表 Standard Ratings

| Rated voltage (V) | Rated capacitance (uF) | Case size $\Phi D \times L$ (mm) | ESR (m Ω) at 20°C, 100 KHz | Leakage Current (μA) | Rated ripple current (mA _{rms} /105°C/100kHz) |
|-------------------|------------------------|----------------------------------|------------------------------------|-----------------------------|--|
| 50 | 10 | 6.3*9 | 100 | 299 | 800 |
| | 22 | 6.3*9 | 100 | 299 | 850 |
| | 33 | 8*9.8 | 60 | 299 | 1300 |
| | 47 | 8*12.6 | 60 | 299 | 1500 |
| | 68 | 8*12.6 | 60 | 340 | 1500 |
| | 100 | 8*12.6 | 60 | 500 | 1500 |
| | 120 | 10*12.6 | 55 | 600 | 2100 |
| | 220 | 10*12.6 | 55 | 1100 | 2100 |
| 63 | 10 | 6.3*9 | 110 | 299 | 750 |
| | 22 | 8*9.8 | 60 | 299 | 1100 |
| | 33 | 8*9.8 | 60 | 299 | 1100 |
| | 33 | 8*12.6 | 60 | 299 | 1300 |
| | 47 | 8*12.6 | 60 | 299 | 1300 |
| | 68 | 8*12.6 | 60 | 428 | 1300 |
| | 82 | 10*12.6 | 55 | 517 | 1800 |
| | 100 | 10*12.6 | 55 | 630 | 1800 |
| 80 | 10 | 6.3*9 | 120 | 299 | 550 |
| | 22 | 8*9.8 | 80 | 299 | 1100 |
| | 22 | 8*12.6 | 70 | 299 | 1300 |
| | 33 | 8*12.6 | 70 | 299 | 1300 |
| | 47 | 10*12.6 | 60 | 376 | 1800 |
| 100 | 10 | 8*9.8 | 90 | 299 | 850 |
| | 15 | 8*12.6 | 70 | 299 | 1190 |
| | 22 | 10*12.6 | 60 | 299 | 1550 |
| | 33 | 10*12.6 | 60 | 330 | 1550 |



H6 Series

- Low ESR, high ripple current, high voltage
- Load life of 2000 hours at 105°C
- RoHS Compliant

◆ 规格表 Specifications

| 项目 Items | 特性参数 Characteristics | | |
|---|---|-------------------------------|------------------|
| 使用温度范围 Category Temperature Range | -55 ~ +105°C | | |
| 额定工作电压范围 Rated Voltage Range | 10 ~ 50V | | |
| 静电容量允许偏差 Capacitance tolerance | ±20%(M) (at 20°C, 120Hz) | | |
| 漏电流 Leakage Current | 施加额定工作电压2分钟后读数, 小于或等于规格值 (at 20°C) I ≤ 0.03CV 或 18μA (取大值) Less than or equal to the specified value. After 2 minutes application of rated Voltage at 20°C | | |
| 损耗角正切值 tanδ Dissipation Factor | Rated voltage (V) | 10~50 | (at 20°C, 120Hz) |
| | tanδ (Max.) | 0.16 | |
| 温度特性 Low Temperature Characteristics (Max.Impedance Ratio) | Z(-25°C)/Z(+20°C) | ≅ 0.75 to 2.0 | (100KHz) |
| | Z(-55°C)/Z(+20°C) | ≅ 0.75 to 1.5 | |
| 耐久性 Endurance | 105°C 施加额定工作电压2000小时, 恢复到20°C后, 产品性能应满足以下要求 The specifications listed below shall be satisfied when the capacitors are restored to 20°C after application of rated voltage for 2000 hours at 105°C. | | |
| | Appearance | No significant damage | |
| | Capacitance change | ≅ ±30% of the initial value | |
| | D.F.(tanδ) | ≅ 200% of the specified value | |
| | ESR | ≅ 200% of the specified value | |
| | Leakage current | ≅ The specified value | |
| 耐湿负荷特性 Damp Heat (Steady State) | 在60°C 温度, 湿度90%~95%RH的环境中, 施加额定电压1000小时后, 恢复到20°C后, 产品性能应满足以下要求 The specifications listed below shall be satisfied when the capacitors are restored to 20°C after application of rated voltage for 1000 hours at 60°C, 90%~95% RH. | | |
| | Appearance | No significant damage | |
| | Capacitance change | ≅ ±30% of the initial value | |
| | D.F.(tanδ) | ≅ 200% of the specified value | |
| | ESR | ≅ 200% of the specified value | |
| | Leakage current | ≅ The specified value | |
| 浪涌电压特性 (Surge Voltage) | 浪涌电压=额定电压× 1.25(V) Surge Voltage=Rated voltage × 1.25(V) 在105°C环境中, 按充电30秒; 放电5分30秒, 连续施加浪涌电压1000次(Rc=1kΩ), 待恢复后测试, 应满足以下要求 The capacitors shall be subjected to 1000 cycles each consisting of charge with the surge voltages specified at 105°C for 30 seconds through a protective resistor (Rc=1kΩ) and discharge for 5 minutes 30 seconds | | |
| | Appearance | No significant damage | |
| | Capacitance change | ≅ ±30% of the initial value | |
| | D.F.(tanδ) | ≅ 200% of the specified value | |
| | ESR | ≅ 200% of the specified value | |
| | Leakage current | ≅ The specified value | |

◆ 外形图 Dimensions (mm)

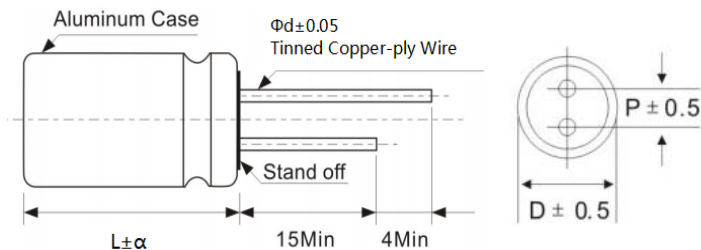

| | | | | |
|----|-----|-----|-----|-----|
| ΦD | 5 | 6.3 | 8 | 10 |
| P | 2.0 | 2.5 | 3.5 | 5.0 |
| Φd | 0.5 | 0.6 | 0.6 | 0.6 |

| | |
|---|----------|
| α | L+1.5Max |
|---|----------|



H6 Series

◆ 纹波电流修正系数 Rated Ripple Current Coefficient

| 频率 Frequency(Hz) | 120Hz \leq f < 1kHz | 1kHz \leq f < 10kHz | 10kHz \leq f < 100kHz | 100kHz \leq f < 500kHz |
|------------------|-----------------------|-----------------------|-------------------------|--------------------------|
| 系数 Coefficient | 0.05 | 0.30 | 0.70 | 1.00 |

◆ 尺寸与个技术参数一览表 Standard Ratings

| Rated voltage (V) | Rated capacitance (μ F) | Case size Φ D×L(mm) | ESR($m\Omega$) at 20°C, 100 KHz | Leakage Current (μ A) | Rated ripple current (mA rms/105°C/100kHz) |
|-------------------|------------------------------|--------------------------|-----------------------------------|----------------------------|--|
| 10 | 100 | 6.3*8 | 40 | 30 | 2000 |
| | 220 | 8*9 | 25 | 66 | 2490 |
| | 470 | 8*12 | 25 | 141 | 2500 |
| | 1000 | 10*12 | 15 | 300 | 3100 |
| 16 | 100 | 6.3*8 | 40 | 48 | 1500 |
| | 270 | 8*9 | 25 | 130 | 2000 |
| | 470 | 8*12 | 25 | 226 | 2250 |
| | 1000 | 10*12 | 18 | 480 | 2900 |
| 25 | 56 | 6.3*8 | 50 | 42 | 1400 |
| | 100 | 8*9 | 30 | 75 | 1900 |
| | 220 | 8*12 | 30 | 165 | 2100 |
| | 330 | 10*12 | 16 | 248 | 2900 |
| 35 | 47 | 6.3*8 | 60 | 49 | 1300 |
| | 100 | 8*9 | 30 | 105 | 1800 |
| | 150 | 8*12 | 30 | 158 | 2100 |
| | 220 | 10*12 | 20 | 231 | 2830 |
| 50 | 15 | 6.3*8 | 80 | 23 | 1200 |
| | 33 | 8*9 | 35 | 50 | 1670 |
| | 100 | 8*12 | 35 | 150 | 1800 |
| | 220 | 10*12 | 25 | 330 | 2650 |



M6 Series

- Low ESR, High ripple, miniaturized
- SMD type: lead free reflow soldering condition at 260°C peak correspondence
- RoHS Compliant

◆ 规格表 Specifications

| 项目 Items | 特性参数 Characteristics | | |
|---|---|-------------------------------|------------------|
| 使用温度范围 Category Temperature Range | -55 ~ +105°C | | |
| 额定工作电压范围 Rated Voltage Range | 10 ~ 50V | | |
| 静电容量允许偏差 Capacitance tolerance | ±20%(M) (at 20°C, 120Hz) | | |
| 漏电流 Leakage Current | 施加额定工作电压2分钟后读数, 小于或等于规格值 (at 20°C) I ≤ 0.03CV 或 18μA (取大值) Less than or equal to the specified value. After 2 minutes application of rated Voltage at 20°C | | |
| 损耗角正切值 tanδ Dissipation Factor | Rated voltage (V) | 10~50 | (at 20°C, 120Hz) |
| | tanδ (Max.) | 0.16 | |
| 温度特性 Low Temperature Characteristics (Max. Impedance Ratio) | Z(-25°C)/Z(+20°C) | ≅ 0.75 to 2.0 | (100KHz) |
| | Z(-55°C)/Z(+20°C) | ≅ 0.75 to 2.0 | |
| 耐久性 Endurance | 105°C施加额定工作电压2000小时, 恢复到20°C后, 产品性能应满足以下要求 The specifications listed below shall be satisfied when the capacitors are restored to 20°C after application of rated voltage for 2000 hours at 105°C. | | |
| | Appearance | No significant damage | |
| | Capacitance change | ≅ ±30% of the initial value | |
| | D.F.(tanδ) | ≅ 200% of the specified value | |
| | ESR | ≅ 200% of the specified value | |
| | Leakage current | ≅ The specified value | |
| 耐湿负荷特性 Damp Heat (Steady State) | 在60°C 温度, 湿度90%~95%RH的环境中, 施加额定电压1000小时后, 恢复到20°C后, 产品性能应满足以下要求 The specifications listed below shall be satisfied when the capacitors are restored to 20°C after application of rated voltage for 1000 hours at 60°C, 90%~ 95% RH. | | |
| | Appearance | No significant damage | |
| | Capacitance change | ≅ ±30% of the initial value | |
| | D.F.(tanδ) | ≅ 200% of the specified value | |
| | ESR | ≅ 200% of the specified value | |
| | Leakage current | ≅ The specified value | |
| 浪涌电压特性 (Surge Voltage) | 浪涌电压=额定电压× 1.25(V) Surge Voltage=Rated voltage × 1.25(V) 在105°C环境中, 按充电30秒; 放电5分30秒, 连续施加浪涌电压1000次(Rc=1kΩ), 待恢复测试, 应满足以下要求 The capacitors shall be subjected to 1000 cycles each consisting of charge with the surge voltages specified at 105°C for 30 seconds through a protective resistor (Rc=1kΩ) and discharge for 5 minutes 30 seconds. | | |
| | Appearance | No significant damage | |
| | Capacitance change | ≅ ±30% of the initial value | |
| | D.F.(tanδ) | ≅ 200% of the specified value | |
| | ESR | ≅ 200% of the specified value | |
| | Leakage current | ≅ The specified value | |
| 焊接耐热性 Resistance to soldering heat | 按回流焊试验后, 应满足以下要求 Measurement for solder temperature profile shall be made at the capacitor top and the terminal. | | |
| | Capacitance change | ≅ ±10% of the initial value | |
| | D.F.(tanδ) | ≅ 130% of the specified value | |
| | ESR | ≅ 130% of the specified value | |
| | Leakage current | ≅ The specified value | |

◆ 外形图 Dimensions (mm)

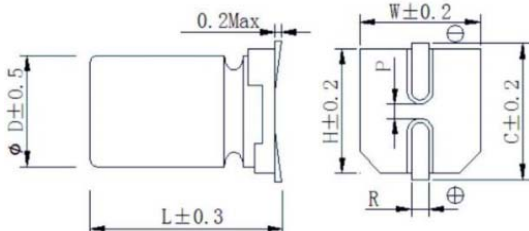

| ΦD | W | H | C | R | P |
|-----|------|------|------|---------|-----|
| 5 | 5.3 | 5.3 | 5.9 | 0.5~0.8 | 1.4 |
| 6.3 | 6.5 | 6.5 | 7.2 | 0.5~0.8 | 2.2 |
| 8 | 8.3 | 8.3 | 9.0 | 0.7~1.1 | 3.1 |
| 10 | 10.3 | 10.3 | 11.0 | 0.7~1.1 | 4.5 |



M6 Series

◆ 纹波电流修正系数 Rated Ripple Current Coefficient

| 频率Frequency(Hz) | 120Hz \leq f < 1kHz | 1kHz \leq f < 10kHz | 10kHz \leq f < 100kHz | 100kHz \leq f < 500kHz |
|-----------------|-----------------------|-----------------------|-------------------------|--------------------------|
| 系数 Coefficient | 0.05 | 0.30 | 0.70 | 1.00 |

◆ 尺寸与个技术参数一览表 Standard Ratings

| Rated voltage (V) | Rated capacitance (μ F) | Case size Φ D×L(mm) | ESR($m\Omega$) at 20°C, 100 KHz | Leakage Current (μ A) | Rated ripple current (mA _{rms} /105°C/100kHz) |
|-------------------|------------------------------|--------------------------|-----------------------------------|----------------------------|--|
| 10 | 100 | 6.3*9 | 40 | 30 | 2000 |
| | 220 | 8*9.8 | 25 | 66 | 2490 |
| | 470 | 8*12.6 | 25 | 141 | 2500 |
| | 1000 | 10*12.6 | 15 | 300 | 3100 |
| 16 | 100 | 6.3*9 | 40 | 48 | 1500 |
| | 270 | 8*9.8 | 25 | 130 | 2000 |
| | 470 | 8*12.6 | 25 | 226 | 2250 |
| | 1000 | 10*12.6 | 18 | 480 | 2900 |
| 25 | 56 | 6.3*9 | 50 | 42 | 1400 |
| | 100 | 8*9.8 | 30 | 75 | 1900 |
| | 220 | 8*12.6 | 30 | 165 | 2100 |
| | 330 | 10*12.6 | 16 | 248 | 2900 |
| 35 | 47 | 6.3*9 | 60 | 49 | 1300 |
| | 100 | 8*9.8 | 30 | 105 | 1800 |
| | 150 | 8*12.6 | 30 | 158 | 2100 |
| | 220 | 10*12.6 | 20 | 231 | 2830 |
| 50 | 15 | 6.3*9 | 80 | 23 | 1200 |
| | 33 | 8*9.8 | 35 | 50 | 1670 |
| | 100 | 8*12.6 | 35 | 150 | 1800 |
| | 220 | 10*12.6 | 25 | 330 | 2650 |

X-ON Electronics

Largest Supplier of Electrical and Electronic Components

Click to view similar products for [Aluminum Electrolytic Capacitors - Leaded](#) category:

Click to view products by [Ruilong](#) manufacturer:

Other Similar products are found below :

[LXY50VB4.7M-5X11](#) [MAL203125221E3](#) [MAL204216159E3](#) [ESMG101ETD100MF11S](#) [RBC-25V-10UF-4X7](#) [RE3-35V222MJ6#](#) [RFO-100V471MJ7P#](#) [B41041A2687M8](#) [B41041A7226M8](#) [B41044A7157M6](#) [EKRG250ELL100MD07D](#) [EKXG201EC3101ML20S](#)
[EKXG351ETD6R8MJ16S](#) [EKZM160ETD471MHB5D](#) [EPA-201ELL151MM25S](#) [NCD681K10KVY5PF](#) [NRLF103M25V35X20F](#)
[KM4700/16](#) [KME50VB100M-8X11.5](#) [RXJ222M1EBK-1625](#) [SG220M1CSA-0407](#) [ES5107M016AE1DA](#) [ESX472M16B](#) [MAL211929479E3](#)
[40D506F050DF5A](#) [TE1202E](#) [36DA273F050BB2A](#) [KME25VB100M-6.3X11](#) [511D336M250EK5D](#) [511D337M035CG4D](#)
[515D477M035CG8PE3](#) [052687X](#) [EKMA500ELL4R7ME07D](#) [EKRG100ETC221MF09D](#) [NRE-S560M16V6.3X7TBSTF](#)
[ERZA630VHN182UP54N](#) [MAL214099813E3](#) [MAL211990518E3](#) [MAL204281229E3](#) [NEV680M35EF](#) [686KXM050M](#) [ERS1VM222L30OT](#)
[EGW2GM150W16OT](#) [EGS2GM6R8G12OC](#) [EHS2GM220W20OT](#) [ERF1VM222L30OT](#) [ERF1KM151G20OT](#) [EKZE500ELL101MHB5D](#)
[EKMM251VSN221MP25S](#) [RGA221M1HBK-1016G](#)