



目 录

TABLE OF CONTENTS

公司简介 Company Profile	P1
固体电解质铝电解电容器特性介绍 Introduction	P2~P3
产品一览表 Product List	P4
产品系统图 SERIES CHART	P5
料号说明 Explanation of parts numbers	P6
加工方式 Diagram of Lead Cutting And Forming or Taping	P7~P10
使用注意事项 Attention before using	P11~P18
固体电解质铝电解电容器失效模式及原因分析 Typical failure modes and factors of aluminum electrolytic capacitors	P19
生产流程图 Production Flow Chart	P20
引线式固体电解质铝电解电容器 Radial Type Conductive Polymer Aluminum Solid Electrolytic Capacitors	P21~46
贴片式固体电解质固态铝电解电容器 SMD Type Conductive Polymer Aluminum Solid Electrolytic Capacitors	P47~58
混合型铝电解电容器 Hybrid Conductive Polymer	P59~62



公 司 简 介

肇庆市瑞隆电子有限公司是一家专业生产固态铝电解电容器的创新型公司。企业的主导产品是全系列的固态铝电解电容器，月产能在1500万只以上。固态铝电解电容具备环保、低阻抗、高低温稳定、耐高纹波及高信赖度等优越特性，且导电性、频率特性及寿命均佳，适用于低电压、高电流的应用中。主要应用于各类照明电源、适配器、智能机器人、工业计算机、汽车电子等。

瑞隆电子集研发、生产、制造于一体，并成功研发出同行业内先进、高效的生产设备及工艺，且已得到业内的推广使用。并研发出最新型的高、中、低压SMD固态电容器，产品可靠性高、性能优异。

肇庆市瑞隆电子有限公司拥有雄厚的技术力量，先进的生产设备工艺，完善的检测手段，致力于成为固态铝电解电容器的全球最佳供应商之一。



■ 产品特性

● 固体电解质铝电解电容器具有的优势（下图中，CL为固态电容、AL为液态电电解电容）

● 在高频下具有极低阻抗（低ESR）

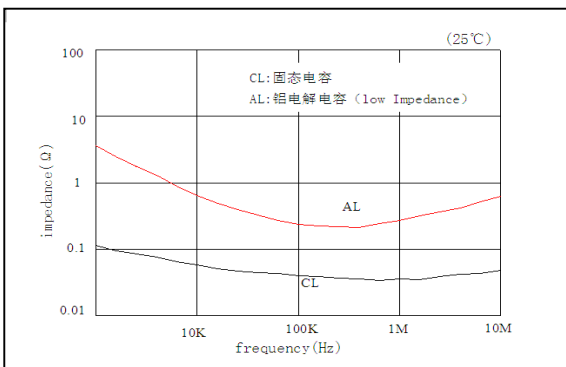

● 具有极小的温度特性偏差

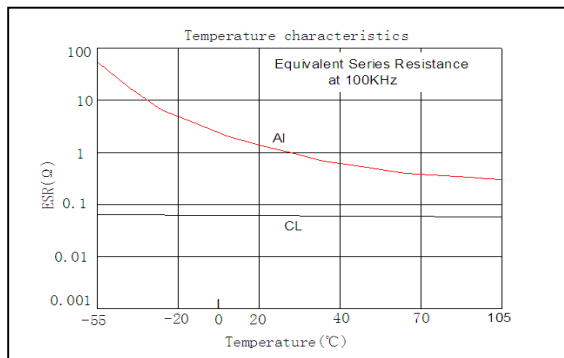

● 耐高纹波电流

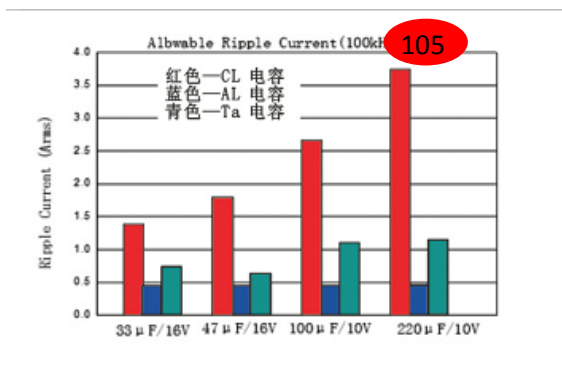

● 利于电路设计小型化。

● 安全性，避免爆浆可能

■ 应用电路

输入、输出平滑电路

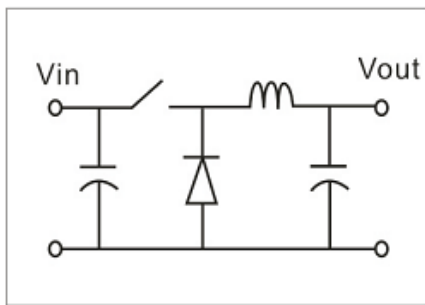

储能电路、旁路

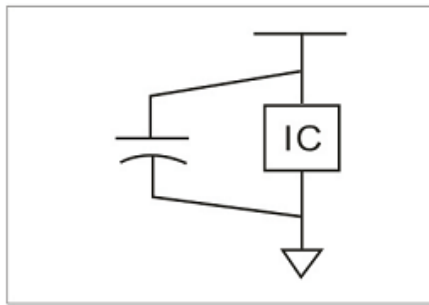

滤波电路

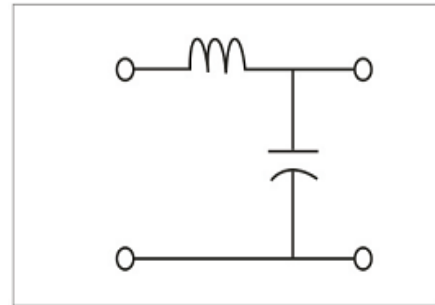

■ 应用设备

微型计算机

数码产品

工业计算器

薄型DVD

液晶电视

LED驱动

汽车导航

精密电源



■FEATURES

Advantages of Conductive Polymer Aluminum Solid Electrolytic Capacitor (in below diagram, CL=Solid Capacitor, AL=Aluminum Electrolytic capacitor)

●With ultra low impedance at high frequency (Low ESR)

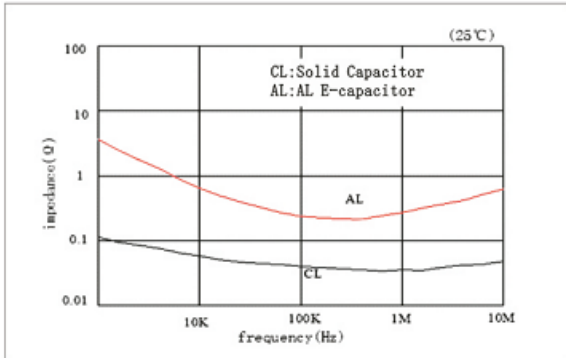

●Stable characteristics at different temperature

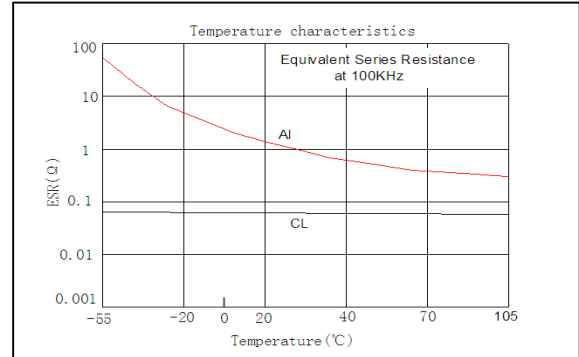

●High ripple current resistance

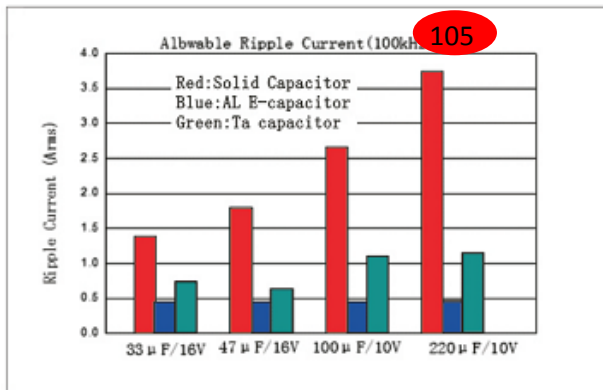

●Good for circuit miniaturization design

●Safty without explosion

■APPLICATIONS to CIRCUIT

Input & output of smoothing circuit

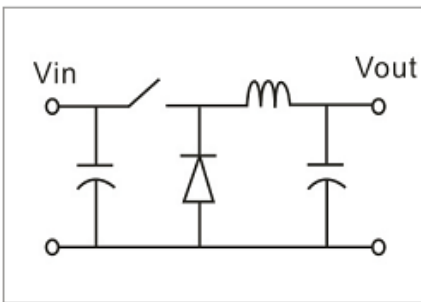

Storage & bypass circuit

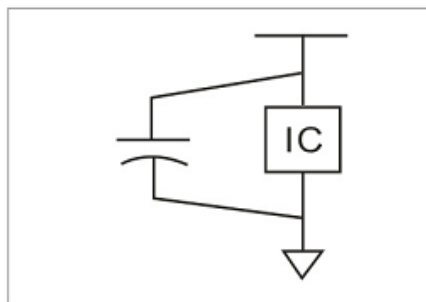

Filtering circuit

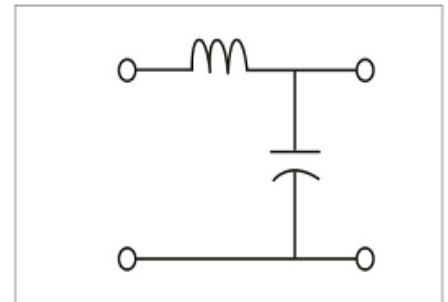

■APPLICATIONS

- | | |
|-------------------|------------------|
| Microcomputer | Digital Products |
| Industry Computer | Slim DVD |
| LCD/LED TV | LED Driver |
| Auto-navigation | Accurate power |



■LIST OF PRODUCTS

Classification	Series	page	Features	Endurance			Rated voltage range (V)	Capacitance range(μF)
				Low Tem. (°C)	High Tem.(°C)	Life (hours)		
Radial type	E1	21~25	Super low ESR, high ripple current	-55	105	2000	2.5~25	22~2200
	E2	26~30	Low ESR, high ripple current	-55	105	2000	2.5~25	22~2200
	E4	31~33	Low ESR, high ripple current, high temperature	-55	125	2000	2.5~25	22~2200
	E5	34~38	Low ESR, high ripple current, long life	-55	105	5000	2.5~25	22~2200
	H2	39~41	Low ESR, high ripple current, high voltage	-55	105	2000	35~100	10~470
	H4	42~43	Low ESR, high ripple current, high voltage, high temperature	-55	125	2000	35~100	10~330
	H5	44~46	Low ESR, high ripple current, high voltage, long life	-55	105	5000	35~100	10~330
SMD type	M1	47~50	Super low ESR, high ripple current	-55	105	2000	2.5~100	10~2200
	M2	51~54	Low ESR, high ripple current	-55	105	2000	2.5~100	10~2200
	M5	55~58	Low ESR, high ripple current, long life	-55	105	5000	2.5~100	10~2200
Radial type	H6	59~60	Low ESR, high ripple current, high voltage	-55	105	2000	10~50	10~1000
SMD type	M6	61~62	Low ESR, high ripple current, high voltage	-55	105	2000	10~50	10~1000

本书所记载的内容可能未经提示而变更，贵司在使用时按敝司的承认书的基准使用。



■产品系统图

■SERIES CHART

●固体电解质铝电解电容器(Conductive Polymer)

Radial type

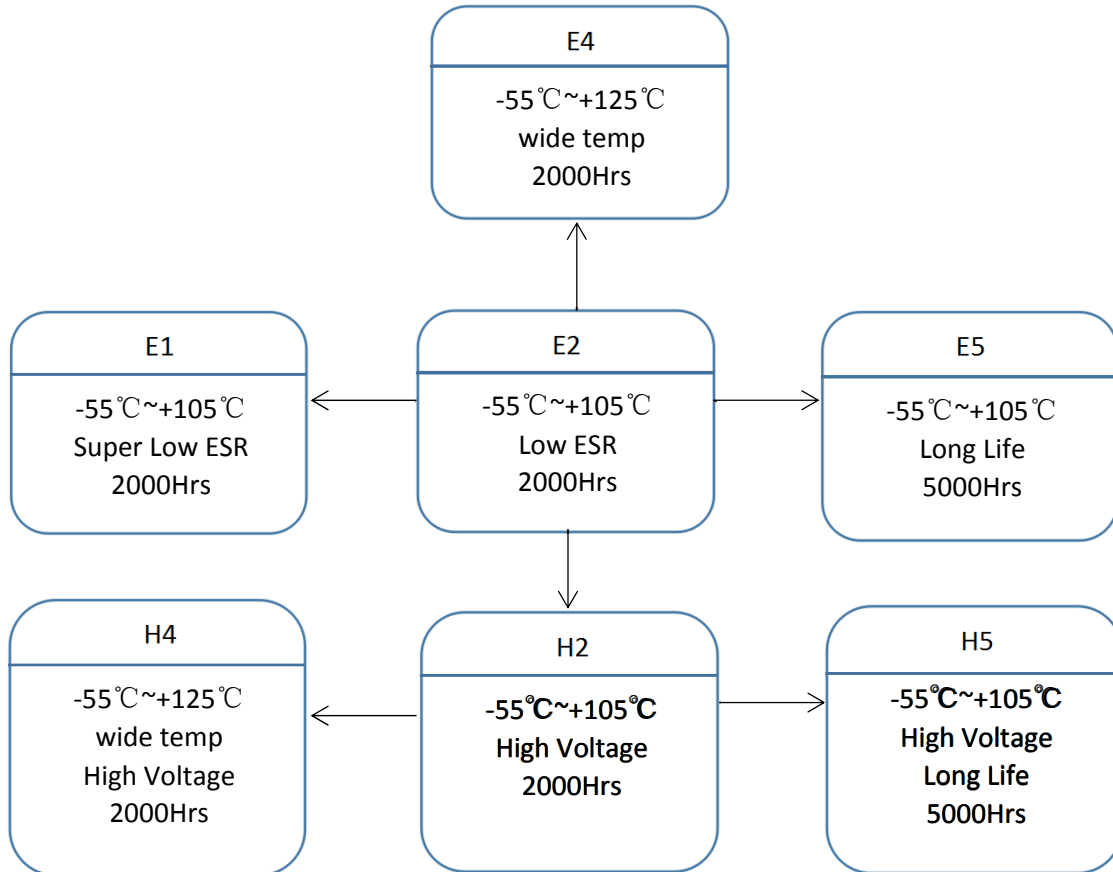

SMD type

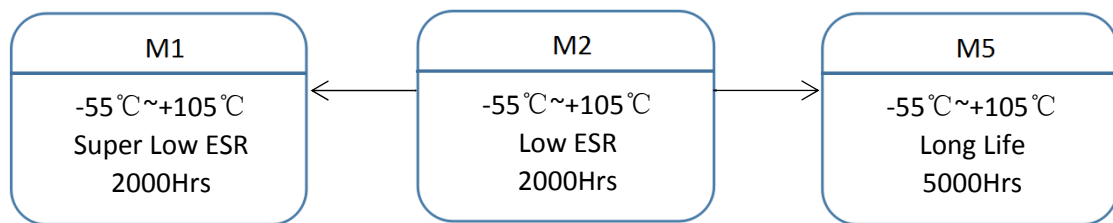

●混合型铝电解电容器(Hybrid Conductive Polymer)

Radial type

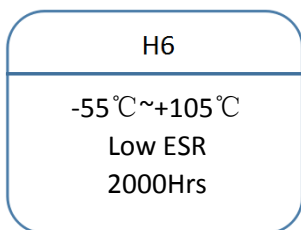

SMD type

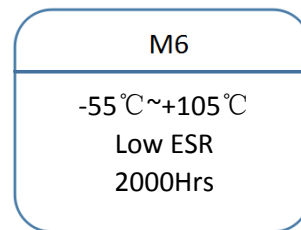



◆料号说明 Explanation of parts numbers

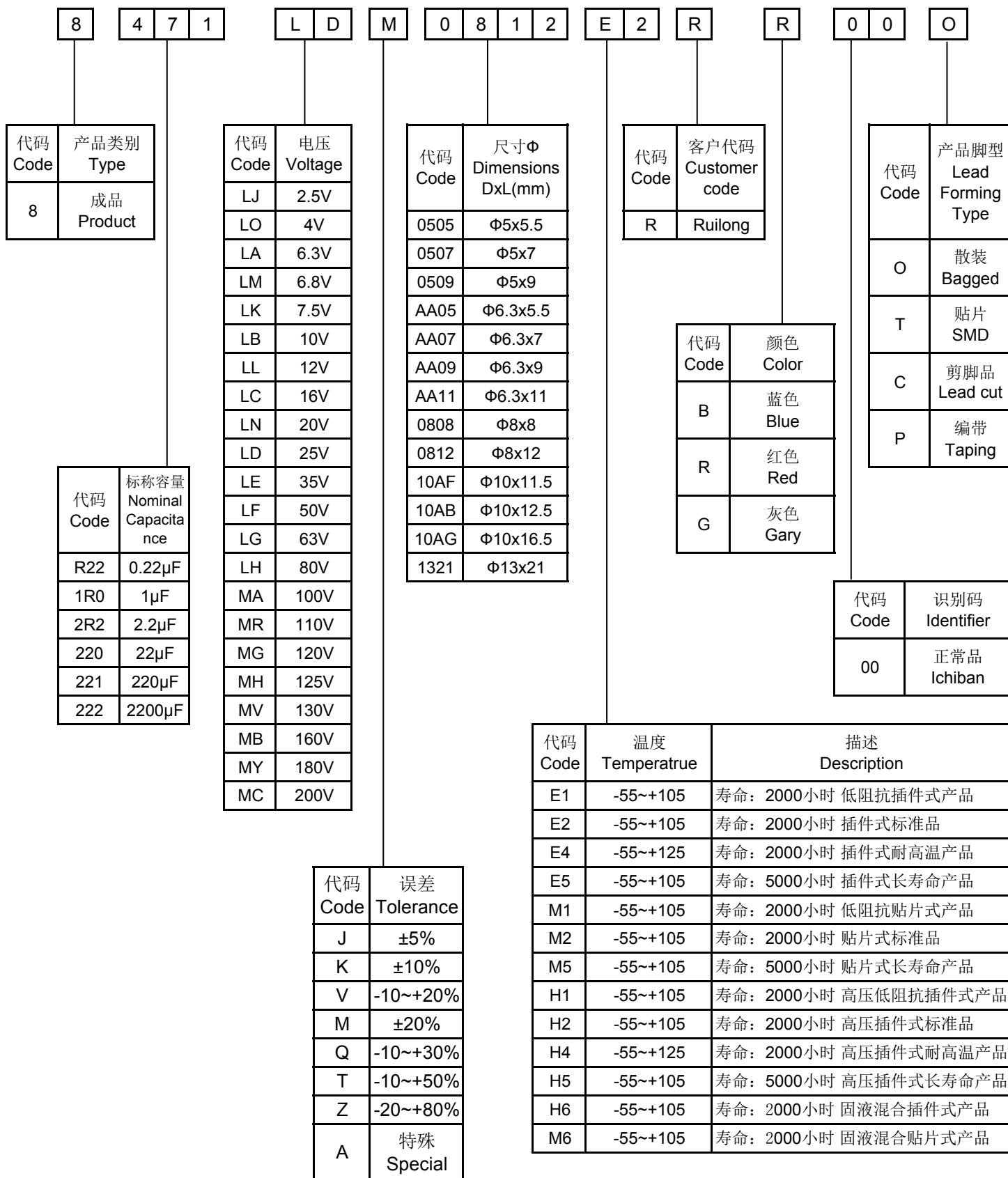



◆ 脚型加工图(尺寸单位mm)

1、LO=导针型长脚 (Long lead)

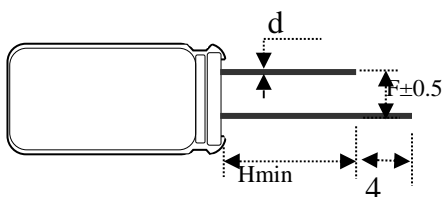

Φ数	4	5	6.3	8	10
d	0.5	0.5	0.6	0.6	0.6
F	1.5	2	2.5	3.5	5
H	15	15	15	15	15

2、LC=直脚切脚 (Lead cut)

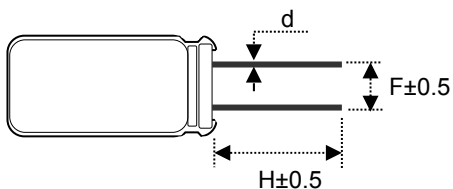

Φ数	4	5	6.3	8	10
d	0.5	0.5	0.6	0.6	0.6
F	1.5	2	2.5	3.5	5
H	依客户要求				

4、PT=平盒编带品 (Radial type) Ammo Taping

[Fig. 1 (Diameter for Φ4 to Φ8)]

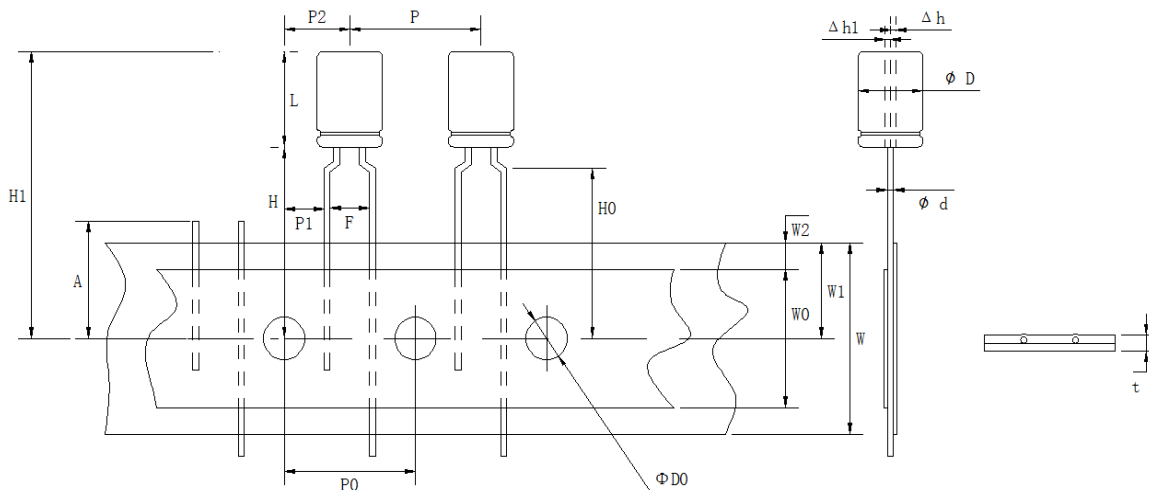

D	L	d	P	P0	P1	P2	F	W	W0	W1	W2	H	H0	D0	A
±0.5	±1.0	±0.02	±1.0	±0.2	±0.7	±1.0	±0.5	±0.5	min	±0.5	max	±0.5	±0.5	±0.2	max
5	8	0.5	12.7	12.7	3.85	6.35	5	18	13	9	1.5	18.5	16	4	11
6.3	8	0.6										18.5			
6.3	12	0.6										18.5			
8	8	0.6										18.5			
8	12	0.6										18.5			



[Fig. 2 (Diameter for $\Phi 4$ to $\Phi 5$)

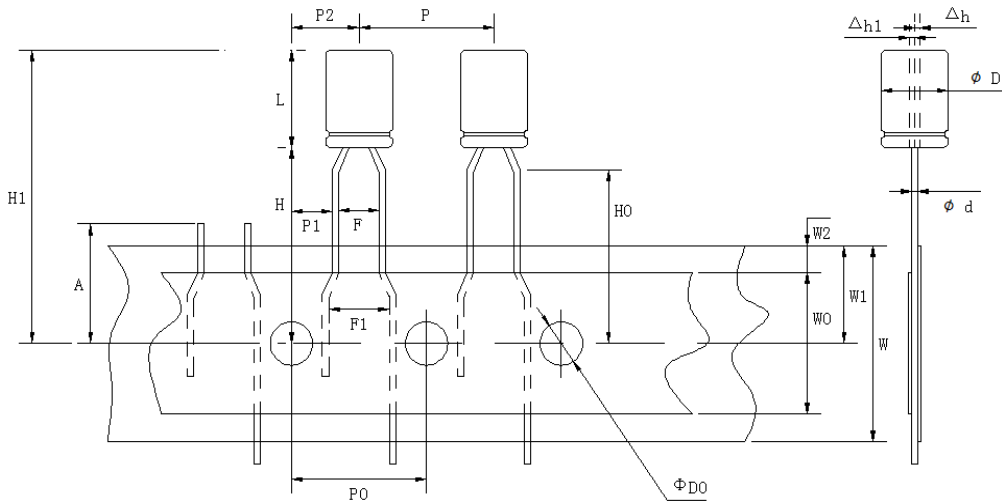

D	L	d	P	P0	P1	P2	F	W	W0	W1	W2	H	H0	D0	A
± 0.5	± 1.0	± 0.02	± 1.0	± 0.2	± 0.7	± 1.0	± 0.5	± 0.5	min	± 0.5	max	± 0.5	± 0.5	± 0.2	max
5	8	0.5	12.7	12.7	5.1	6.35	2.5	18	13	9	1.5	18.5	16.5	4	11

[Fig. 3 (Diameter for $\Phi 6$ to $\Phi 8$)

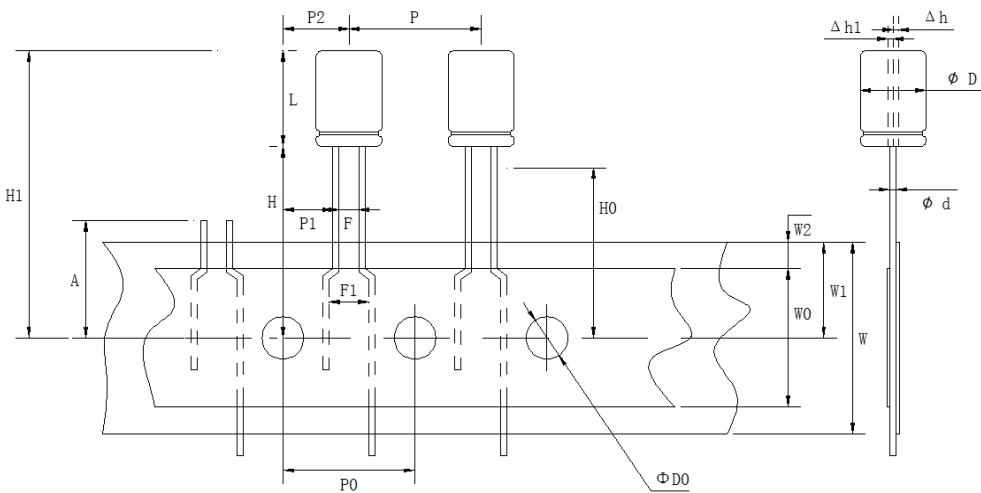

D	L	d	P	P0	P1	P2	F	W	W0	W1	W2	H	D0	A
± 0.5	± 1.0	± 0.02	± 1.0	± 0.2	± 0.7	± 1.0	± 0.5	± 0.5	min	± 0.5	max	± 0.5	± 0.2	max
6.3	8.0	0.6	12.7	12.7	5.4	6.35	2.5	18	13	9	1.5	18.5	4	11
6.3	12.0	0.6					2.5					18.5		
8	8.0	0.6					3.5					18.5		
8	12.0	0.5					3.5					20		



[Fig. 4 (Diameter for $\Phi 10$)]

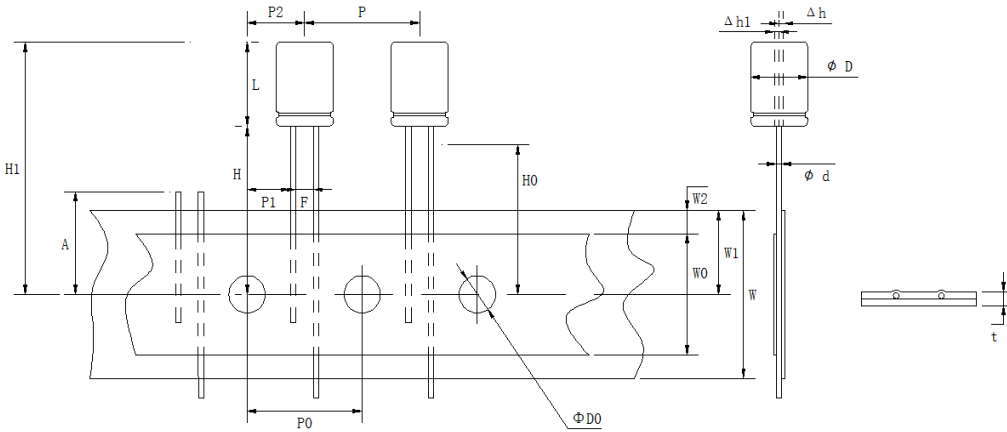

D	L	d	P	P0	P1	P2	F	W	W0	W1	W2	H	D0	A
± 0.5	± 1.0	± 0.02	± 1.0	± 0.2	± 0.7	± 1.0	± 0.5	± 0.5	min	± 0.5	max	± 0.5	± 0.2	max
10	12.0	0.6	12.7	12.7	3.85	6.35	5	18	12.5	9	1.5	20	4	11

● Packing Information

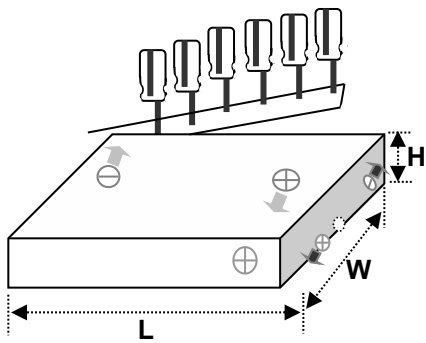

L	W	H	Case size $\Phi D \times L$ (mm)	Q'TY(pcs)
340	250	50	4	2000
340	250	50	5、6.3	2000
340	250	50	8	1000
340	250	50	10	500



5、SMD Type 表面封装电容结构

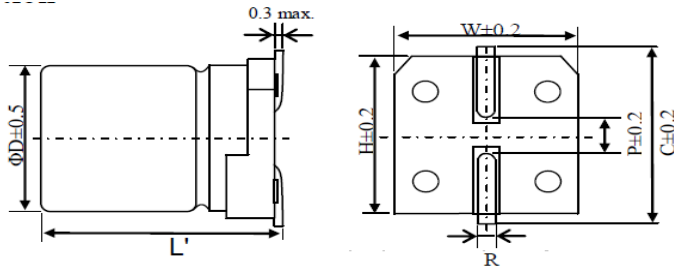

ΦD	W	H	C	R	P
5	5.3	5.3	5.9	0.5~0.8	1.4
6.3	6.5	6.5	7.2	0.5~0.8	2.2
8	8.3	8.3	9.0	0.7~1.1	3.1
10	10.3	10.3	11.0	0.7~1.1	4.5

●SMD TAPING (mm)

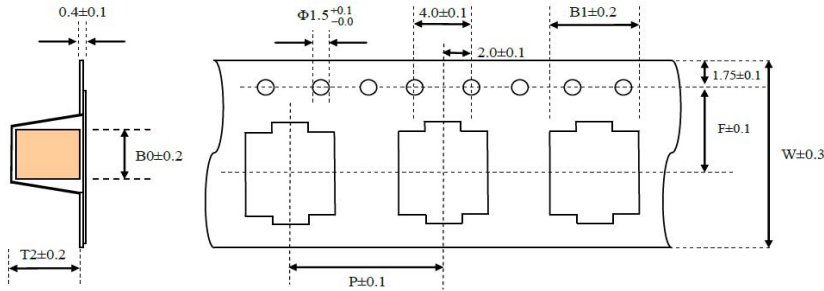

Figure 9

Size	5*3.8~4.5	5*5.7	6.3*3.8~4.5	6.3*5.7	8*6.9	8*9.7	10*12.6
W	12	12.0	16.0	16	24	24	24
P	12	12.0	12.0	12	12	16	16
F	5.5	5.5	7.5	7.5	11.5	11.5	11.5
B1	6.5	6.5	8.6	8.6	8.6	8.6	10.7
B0	5.7	5.7	6.9	6.9	8.6	8.6	10.7
T2	4.7	6.2	4.7	6.2	7.2	10.3	13

●Packing of SMD product

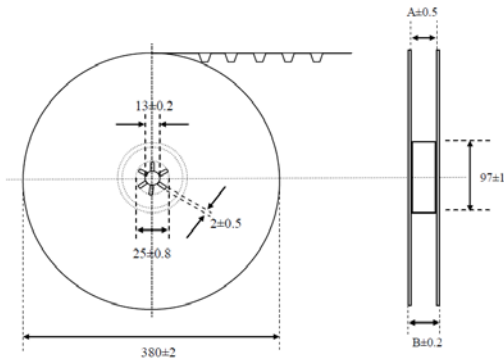

Figure 10

Size	5*3.8~5.7	6.3*3.8~5.7	8*6.9	8*9.7	10*12.6
A	13.5	17.5	25.3	25.3	25.3
B	17.5	21.9	30	30	30

Packaging quantity

Size	pcs/reel	pcs/box
5.0Φ,6.3Φ*3.8L~4.5L	1500	15000
5.0Φ,6.3Φ*5.7L	1200	12000
6.3Φ*7.7L	1000	10000
6.3Φ*9.0L	900	9000
8.0Φ*6.9L	1000	6000

Size	pcs/reel	pcs/box
8.0Φ*9.8L	500	3000
8.0Φ*12.6L	400	2400
10.0Φ*12.6	400	2400



■使用注意事项（固体电解质铝电解电容器）

一、设计方面的确认事项

1、禁止使用电路

固体电解质铝电解电容器（以下简称电容器）有可能因焊接时的热应力使其漏电流发生变化。请避免在对漏电流敏感电路中使用。

- ①高电阻电压保持电路
- ②耦合电路
- ③时间常数电路

2、电路设计

请在确认以下内容的基础上进行电路设计。

- ①随着温度及频率的变化，电容器的电气特性会随之变化。请在确认这些变化之后进行电路的设计。
- ②当并联2个以上的电容器时，请在设计电路时考虑电流的平衡。
- ③当串联2个以上的电容器时，因加载电压存在差异，有可能加载过电压，请使用的时候另行咨询我们。
- ④请勿在电容器的周围以及印刷配线板的背面安装发热部件。

3、极性

固体电解质铝电解电容器是具有极性的电容器。请不要加载反向电压或交流电压。如果安装时极性弄反，有可能导致电路在初始状态短路。

4、加载电压

请不要加载超过额定电压的电压，因为即使电容器只是一瞬间承受超过额定电压的电压，也会导致漏电流增加和发生短路故障。请将和直流电压迭加的纹波电压峰值设定在额定电压以下。

5、纹波电流

请不要叠加超大电流（超过额定纹波电流的电流）。当过大的纹波电流叠加时，可能导致内部的发热量增大，寿命缩短，发生短路故障等。

6、使用温度

如果在超出工作温度范围的环境下使用，会导致性能老化及发生故障，请在工作温度范围内使用。

7、充放电

请不要在反复急速充放电的电路中使用。如果用在反复急速充放电的电路中，可能导致静电容量减少及电容器因内部发热损坏等。当高峰电流值超过了20A时，为了保持信赖性，建议使用保护电路。

8、漏电流

有时候漏电流会上升，但如果在工作温度内加载电压，则会通过利用自我修复作用逐渐减少。此外，此时的漏电流减少的速度，越接近工作上限温度及额定电压就越快。

漏电流上升的原因如下：

- ①焊接
- ②高温无负载、高温高湿、温度急剧变化等试验

9、故障及寿命

（1）故障模式

- ①产品温度上升引起的静电容量减少及ESR的上升引起的开放模式磨损是主要的故障模式。
- ②由于加载超过额定电压的电压引起短路和通电电流过大的时候，会因内压的上升而使得
 - 通过降低周围温度、纹波电流、加载电压可以减少故障率。
 - 设置保护电路、保护装置，确保设备安全。



◆ Attention before using

One、 Confirm before design

1、 Can not be used in below circuits

Conductive polymer aluminum solid electrolytic capacitors (Hereinafter called capacitor) is possible to lead its leakage current to be changed by the thermal stress while soldering. Therefore, please do not use capacitor in a circuit with sensitive leakage current.

- ① Do not use capacitor in a high resistance and high voltage keeping circuit.
- ② Do not use capacitor in a coupling circuit.
- ③ Do not use capacitor in a time constant circuit.

2、 Circuit design

Please confirm below contents before design a circuit.

- ① Before design a circuit, please note that characteristics of capacitor will be changed along with the change of temperature and frequency.
- ② Please consider the current balance when 2 or more capacitors have to be paralleled in a circuit.
- ③ Please connect us while 2 or more capacitors are series in circuit as it's possible that overvoltage would be applied
- ④ Please do not assemble heat generation components around the capacitor or at the back side of PCB.

3、 Polarity

Conductive Polymer Aluminum Solid Electrolytic Capacitor is with polarity. Please do not apply a reverse voltage or current.

Short-circuit will happen to the capacitor if assemble in a reverse polarity.

4、 Load a voltage

Please do not load an over rated voltage as even just for a while, it will cause leakage current increasing and failure of short-circuit.

Please set a peak value of ripple voltage which added DC voltage under the rated voltage.

5、 Ripple current

Please do not load an overcurrent (a current over rated ripple current). While an over ripple current is applied, which will make heat amount inside of capacitor larger, life shorter, short-circuit happened, etc.

6、 Working temperature

Function aging and failure does happen if use capacitor in an ambient temperature over rated working temperature.

Please use capacitor in the range of working temperature.

7、 Charge and discharge

Please do not use capacitor in a repeated rapid charging and discharging circuit. If use it in a repeated rapid charging and discharging circuit

it will cause capacitance reduction or inside failure by heat generation. If peak current is over 20A, Protection Circuit application is suggested

in order to keep its reliability.

8、 Leakage current

Leakage current will increase sometimes, but which will decrease due to restoring itself with application of voltage at the working temperature.

Besides, reduction speed of leakage current will be faster and faster while closer to upper limited temperature and rated voltage.

The reason why leakage current increase is below:

- ① Soldering
- ② High temperature without load、 High humidity and temperature、 Temperature change shirply and test ect.

9、 Failure and Life

(1) Failure Mode

- ① Capacitance reduction by temperature increasing and open model failure by ESR increasing are the major failure mode.
- ② While an over rated voltage or overcurrent is applied, that lead inner pressure increasing. It need
 - to cut down its failure rate by reduce the ambient temperature, ripple current or loading voltage.
 - to assure safety of equipment by setting protective circuit or device.



(2) 寿命推算

$$L_x = L_o \times 2^{\frac{T_o - T_x}{2}} \times 2^{\frac{-\Delta T}{10}}$$

L_x : 在实际使用条件中推算的寿命(小时)

L_o : 工作在额定工作电压和最高工作温度下的寿命(小时)

T_o : 电容最高工作温度(°C)

T_x : 实际使用时的周围温度(°C)

ΔT : 叠加纹波电流时的自我温升(°C)

叠加纹波电流时大致的自我温升 ΔT 可以用以下公式算出:

$$\Delta T' = \Delta T_o \times \left(\frac{I_x}{I_o}\right)^2$$

ΔT_o : 电容器叠加额定纹波电流时的自我温升20°C

I_x : 电容器在实际使用时的纹波电流(Arms)

I_o : 电容器在工作上限温度时的额定纹波电流(Arms)

如需得到更加准确的 ΔT , 推荐使用热电偶进行实测。

10、电容器的绝缘

电容器的外壳和阴极端子及阳极端子和电路型板之间请进行电气绝缘。

11、电容器的使用环境

电容器请不要在以下环境中使用。

- ①直接溅水, 盐水及油, 或者结露状态的环境
- ②阳光直接照射的环境
- ③充满有害气体(硫化氢、亚硫酸、亚硝酸、氯及其化合物、溴及其化合物、氨等)环境
- ④臭氧、紫外线及放射线照射的环境
- ⑤振动或冲击条件超过产品目录或规格说明规定范围的过激环境

12、电容器的配置

- ①请将电容器的端子间隔和印刷配线板的孔间隔对准。
- ②请不要在电容器的封口部下面进行电路配线。如果电容器附件配线, 请确保线路间隔在 1mm(可以的话2mm)以上。
- ③两面印刷配线板上安装电容器时, 设计时应注意电容器下方不可有多余的基板孔或表里连接用贯通孔。
- ④两面印刷配线板上装配电容器时, 电容器主体的安装部位不可有配线线路。

二、安装

1、组装时

- ①已经成套组装并通过电的电容器请勿再次使用。
- ②电容器内可能产生再生电压。此时, 请通过1KΩ左右的电阻进行放电。
- ③在超过常温35°C、湿度75%RH的条件下, 超过产品目录或规格说明书的规定期限进行长期保管时, 电容器的漏电流有可能增大。此时, 请通过1KΩ左右的电阻放电后使用。
- ④安装前请确认电容器的规格(静电容量及额定电压)
- ⑤安装前请确认电容器的极性。
- ⑥请勿使用跌落到地板等上的电容器。
- ⑦安装时请勿使电容器变形。
- ⑧请确认电容器的端子间隔和印刷配线板孔间隔是否对准后, 再进行安装。
- ⑨请不要在电容器上施加过大机械强度的力。

如果在电容器上施加过强的力, 电极端子会折断或变形, 从而影响到安装。此外, 还有可能导致短路、断线、漏电流增大和外包装破损等。自动装配机在对准吸附安装位置以及切断引线时也有坑内产生应力, 请注意它的冲击力。

2、焊接时的焊接耐热

(1) 电烙铁焊接

焊接时, 其焊接时间和焊接温度不应超过10秒钟及260摄氏度。注意不要将焊锡附在端子以外的电容器表面上; 电烙铁等高温发热装置应与电解电容器塑料外壳保持适当的距离, 以防止过热造成塑料破裂。



(2) Lifetime Estimation

$$L_x = L_o \times 2^{\frac{T_o - T_x}{2}} \times 2^{\frac{-\Delta T}{10}}$$

L_x : Estimation of actual lifetime (h)

L_o : Specified lifetime with the rated voltage at the upper limit of the category temperature (h).

T_o : Maximum category temperature (°C)

T_x : Actual ambient temperature of the capacitor (°C)

ΔT : Rise of internal temperature due to the rated ripple current (°C)

An approximate value of ripple current-caused ΔT can be calculated using Equation

$$\Delta T = \Delta T_o \times \left(\frac{I_x}{I_o}\right)^2$$

ΔT_o : Rise in internal temperature due to the rated ripple current (20°C)

I_x : Operating ripple current (Arms) actually flowing in the capacitor

I_o : Rated ripple current (Arms), frequency compensated, at the upper limit of the category temperature range

To determine more accurate values of ΔT , they can be actually measured using a thermocouple.

10、Insulation to Capacitor

Electrical insulation should be made between case and negative terminal, positive terminal and PCB.

11、Using environment of capacitor

Do not use capacitor in below environment

- ① Under the environment of splash water directly, salt water and oil .
- ② an environment will be exposed to direct sunlight
- ③ an environment with hazardous gas or fumes (such as H₂S、 H₂SO₃、 HNO₂、 Cl & chloride、 Br & bromide、 NH₃、 etc)
- ④ an environment with O₃ ,ultraviolet ray and radiation exposure
- ⑤ an environment with serious shake or shock condition over specified range in catalogue.

12、Circuit route design concerning capacitor on PCB

- ① Distance between terminals of capacitor must fit distance between holes on PCB.
- ② Please do not design a circuit route through the capacitor covering area on PCB. If it is necessary, please keep space to be 1mm (2mm if possible) or more.
- ③ If capacitor will be assembled onto a double-layer PCB, please note that hole should not be in the capacitor covering area on the PCB. Connection should be with Through Hole.
- ④ If capacitor will be assembled onto a double-layer PCB, circuit route can not go through the capacitor cover area on PCB.

Two、Assembly

1、Assembly

- ① Please do not use a capacitor which had been ever assembled and charged before.
- ② Inside capacitor may regenerate electricity. Please discharge it with a 1KΩ resistor.
- ③ Storage in a environment over 35°C and 75%RH for a long time over the term specified in catalogue or datasheet, static electricity maybe generate inside capacitor. Please use it after discharged with a 1KΩ resistor.
- ④ Please confirm the specification of capacitor (capacitance and rated voltage) before assembly.
- ⑤ Please confirm the polarity of capacitor before assembly.
- ⑥ Please do not use a capacitor which ever dropped on the floor.
- ⑦ Please do not deform capacitor during assembly.
- ⑧ Please confirm distance between terminals of capacitor if fit the distance between holes on PCB before assembly.
- ⑨ Please do not apply an over physical stress during assembly.
If not, over physical stress will make terminals to be broken or deformed as well as make capacitor to be short-circuit, connection broken, leakage current increasing, sleeving damaged,etc.
Please be careful the assembling stress during assembling in auto-assembly machine.

2、Soldering heat resistance

(1) Soldering with iron probe

During soldering, time and temperature can not exceed 10 seconds and 260°C, as well as soldering tin can not adhere onto any part of capacitor surface except terminals. Heat generating devices such as Soldering Iron are kept away from plastic sleeving of capacitor. If not, over heat will crack it.



(2) 正流焊接（不适用SMD品）

请在以下正流焊流的条件范围内

步骤	温度	时间	次数
预热	120℃以下	120秒以下	1次
焊接	260±5℃	10秒以下	1次或2次

(3) 回流焊（仅限于SMD品）

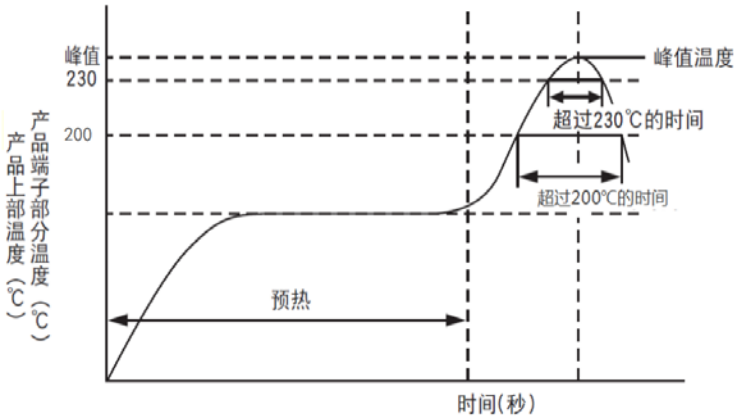

额定电压 (Vdc)	预热	超过200℃的时间	超过230℃的时间	峰值温度	回流次数
2.5~10V	150~180℃ ≦120秒	≦90秒	≦50秒	260℃	1次时
				250℃	2次时
12~25V		≦90秒	≦50秒	240℃	1次时
		≦80秒	≦40秒	240℃	2次时

注：第二次回流焊之前，必须让电容器温度冷却到室温。

3、焊接后的处理

应不产生以下的机械应力：包括使电容器发生倾倒、扭转；使电容器碰到线路板或其它组件

4、焊接后清洗：

清洗剂	清洗方法
Pine Alpha ST-100S Clean Through 750H IPA(异丙醇) Aqua Cleaner 210SEP	使用浸渍、超声波等方法，清洗剂为60℃以下，清洗时间不超过5分钟，清洗后，请将安装电容器的电路板以热风干燥10分钟以上（热风温度控制电容器的上限类别温度以下）

- (1) 请不要使用含卤溶剂、强碱类、石油类溶剂以及含有二甲苯、丙酮溶剂的清洗剂
- (2) 为保护地球环境，请充分做好清洗剂污染管理(电导率、PH值、比重、水分含水率等)
- (3) 根据不同的清洗方法，有时会造成产品标识模糊等后果

5、使用固定剂、涂层剂时，请确认以下内容：

- (1) 不使用含卤素的固定剂、树脂涂层剂。
- (2) 在使用固定剂、涂层剂前，请将电路板与电容器之间清扫干净，不能残留焊接残渣及污垢；
- (3) 固定剂，涂层剂吸附前，确保无清洗液残留，并进行干燥处理。
- (4) 固定剂，涂层剂吸附前，请勿将电容器封口部分的整个面堵塞。

6、熏蒸处理

在电子设备类进出口时，有时需用溴化甲烷等卤素化合物进行熏蒸处理。此时，如果铝电解电容器接触到溴化甲烷等卤素化合物，会和【基板清洗】一样，有产生卤素离子而产生腐蚀反应的危险。本公司在进出口的时候，采用的是无需熏蒸处理的包装方式。客户在进出口电子设备，本成品及铝电解电容器单体的时候，请注意有无熏蒸处理，最终的包装形态等。（即使用瓦楞纸箱、塑料等进行包装，熏蒸其他还是有侵入内部的危险。）

三、保养检查注意事项

- 1、请定期检查使用于工业设备上的电容器。对电容器进行保养检查的时候，请先切断设备的电源，放掉电容器内的存储电。当用万用表检查时，请先确认万能表的极性后再使用。
- 2、请按以下内容进行定期检查。
 - ①外观有无明显异常
 - ②电气性能（静电容量、损失角正切值、漏电流）及产品目录书
 当以上内容有异常时，请确认电容器的规格，并进行替换等恰当的处理。



(2) Flow soldering (not suitable for SMD parts)

Please follow below flow soldering conditions

Step	Temperature	time	times
Preheat	under 120°C	< 120 sec	1
Solder	260±5°C	< 10 sec	1 or 2

(3) Reflow soldering (for SMD parts only)

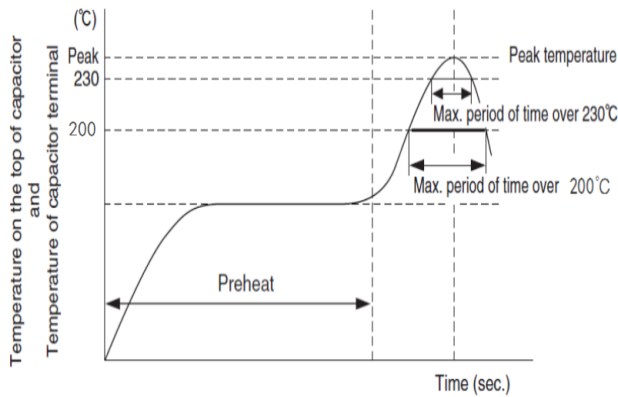

Voltage range(Vdc)	Preheat	Time maintained above 200°C	Time maintained above 230°C	Peak temp.	Reflow number
2.5 to 10V	150 to 180°C	90 sec. max.	50 sec. max.	260°C max.	1-cycle only
				250°C max.	2-cycles allowed
12 to 25V	120 sec. max.	90 sec. max.	50 sec. max.	240°C max.	1-cycle only
				80 sec. max.	40 sec. max.

Note: The second reflow soldering shall be applied after the temperature of capacitors decreases down to the room temperature.

3、After soldering

Can not withstand a physical stress that: make capacitor fall down, turn around or make it touch PCB or other components on PCB.

4、PDB cleaning after soldering:

cleaning agent	method of cleaning
Pine Alpha ST-100S	Clean by immersion and ultrasonic, as well as the temperature of the cleaning agent shall be lower than 60°C。Cleaning time should be within 5 minutes. After cleaning, PCB with capacitors should be dried with hot air for 10 minutes. (Temperature of hot air should be under the specified max temperature of the capacitor.)
Clean Through 750H	
IPA	
Aqua Cleaner 210SEP	

- (1) Cleaning agent for capacitors should not contain any Alkali solvent, petroleum, base solvents, xylene, acetone.
- (2) In order to protect the environment, the solvents should be serious management (such as conductivity, PH, special gravity and water contents).
- (3) According to the different way of cleaning, maybe cause a blur of the marking.

5、Please confirm using adhesives and coating materials as follow:

- (1) Do not use halogenated adhesives and coating materials to fix capacitors.
- (2) Flux between the surface of the PCB and sealing of Capacitors should be clean before using adhesives and coating materials.
- (3) Please clean remains of agent and dry PCB before using adhesives and coating materials.
- (4) Do not cover up all of the sealing area of the capacitors before using adhesives or coating materials.

6、Fumigation

While import or export electronic equipments, sometimes it need to do fumigation with halide such as Methyl Bromide. If capacitor is touched by halide such as Methyl Bromide during which. That maybe lead corrosive reaction caused by halide ion just like 【PCB cleaning】

Our capacitors are packed without fumigation during import and export. Customers: please pay attention to the fumigation, final packing while import and export electronic equipments.

(During fumigation, there is risk that halide ion will go inside even packed with paper carton, plastic, etc.)

Three、Maintenance and checking

- 1、Please regularly check capacitors inside industrial equipment. Before doing maintenance and checking to capacitors, please turn off the power and discharge capacitors. Please confirm polarity of multimeter while checking capacitor with it.
- 2、Please check capacitor based on below:
 - ① Obvious abnormal appearance or not.
 - ② Electrical characteristics (Capacitance、Dissipation Factor、 Leakage current)and product catalogue.
 If abnormal was found, please replace it by a new one with the same specification.



四、紧急情况

- 1、设备使用时，当电容器产生了气体，短路引起了燃烧，或者产生恶臭和发出烟雾时，请切断设备的主电源，或者从插座上拔了电源线的插头。
- 2、当电容器异常或者燃烧时，有可能外包装树脂等燃烧和分解产生气体。因此，请不要将脸和手靠近。当喷出的气体进入眼睛，或吸入的时候，请马上用水洗眼、漱口。当粘附在皮肤上时，请用肥皂冲洗。

五、保管

请按照以下保管条件保管电容器。

- 1、不可将电容器保管在高温、高湿环境下。请保管在室温5~35℃、湿度75%以下的环境。

保管期限请参照下表。

Items	拆包前	拆包后
SMD品（贴片型）	制作后2年内	自拆封日起1个月内
引线型	制作后2年内	——

- 2、请不要将电容器保管在溅水、盐水及油的环境下。
- 3、请不要将电容器保管在充满有害气体（硫化氢、亚硫酸、压硝酸、氯及其化合物、溴及其化合物、溴化甲烷等卤素化合物、氨等）环境下。
- 4、请不要将电容器保管在臭氧、紫外线及放射线照射的环境下。
- 5、请尽可能包装好保管。

六、废弃处理

请交给专业的工业废弃物处理厂进行处理。

七、有害物质限用指令（RoHS）

我司产品符合欧盟对有害物质限用之规定。

铅（Pb）	≤1000ppm
汞（Hg）	≤1000ppm
镉（Cd）	≤100ppm
铬（Cr）	≤1000ppm
多溴化联苯（PBBs）	≤1000ppm
多溴联苯醚（PBDEs）	≤1000ppm

无卤声明

我司产品符合下列卤素含量限制

溴（Br）	900ppm
氯（CL）	900ppm
溴（Br）+氯（CL）	1500ppm



Four、Emergency

- 1、 If capacitor generated gas,smell, smoke or got burning from short-circuit, please turn off the main power source or pull out the plug from the electric outlet.
- 2、 Do not bring your face or hands near the emitting gas from capacitor when sealing rosin of an abnormal capacitor was burning or decomposing. If the gas gets into your eyes or you breathe the gas, please flush your eyes or rinse your mouth and throat with clean water immediately.
If the gas splash onto your skin, please wash it away with soap and water immediately.

Five、Storage

Please store capacitors according to below conditions:

- 1、 Indoor storage at a place with ambient temperature of 5℃ to 35℃ , and relative humidity lower than 75%.

Storage terms:

Item	Before unpack	After unpack
SMD Type	Within 2 years after production	within 1 months since unpack
Radial type	Within 2 years after production	—

- 2、 Pls don't keep it under the environment of jawp ,salt water and oil.
- 3、 Please do not store capacitor in an environment with hazardous gas or fumes (such as H₂S、 H₂SO₃、 HNO₂、 Cl & chloride、 Br & bromide、 NH₃、 etc)
- 4、 Please do not store capacitor in an environment with O₃ ,ultraviolet ray and radiation exposure
- 5、 Please keep its package as good as possible.

Six、Scrap

Send them to the industrial waste processing plant.

Sseven、Restriction of Hazardous Substance Direcive (RoHS)

Our products are RoHS compliant.

(Pb)	≤1000ppm
(Hg)	≤1000ppm
(Cd)	≤100ppm
(Cr)	≤1000ppm
(PBBs)	≤1000ppm
(PBDEs)	≤1000ppm

Halogen-free Statement

Our products are below halogen content limit compliant.

(Br)	900ppm
(CL)	900ppm
(Br) + (CL)	1500ppm



◆ 固体电解质铝电解电容器失效模式及原因分析.

◆ Typical failure modes and factors of aluminum electrolytic capacitors.

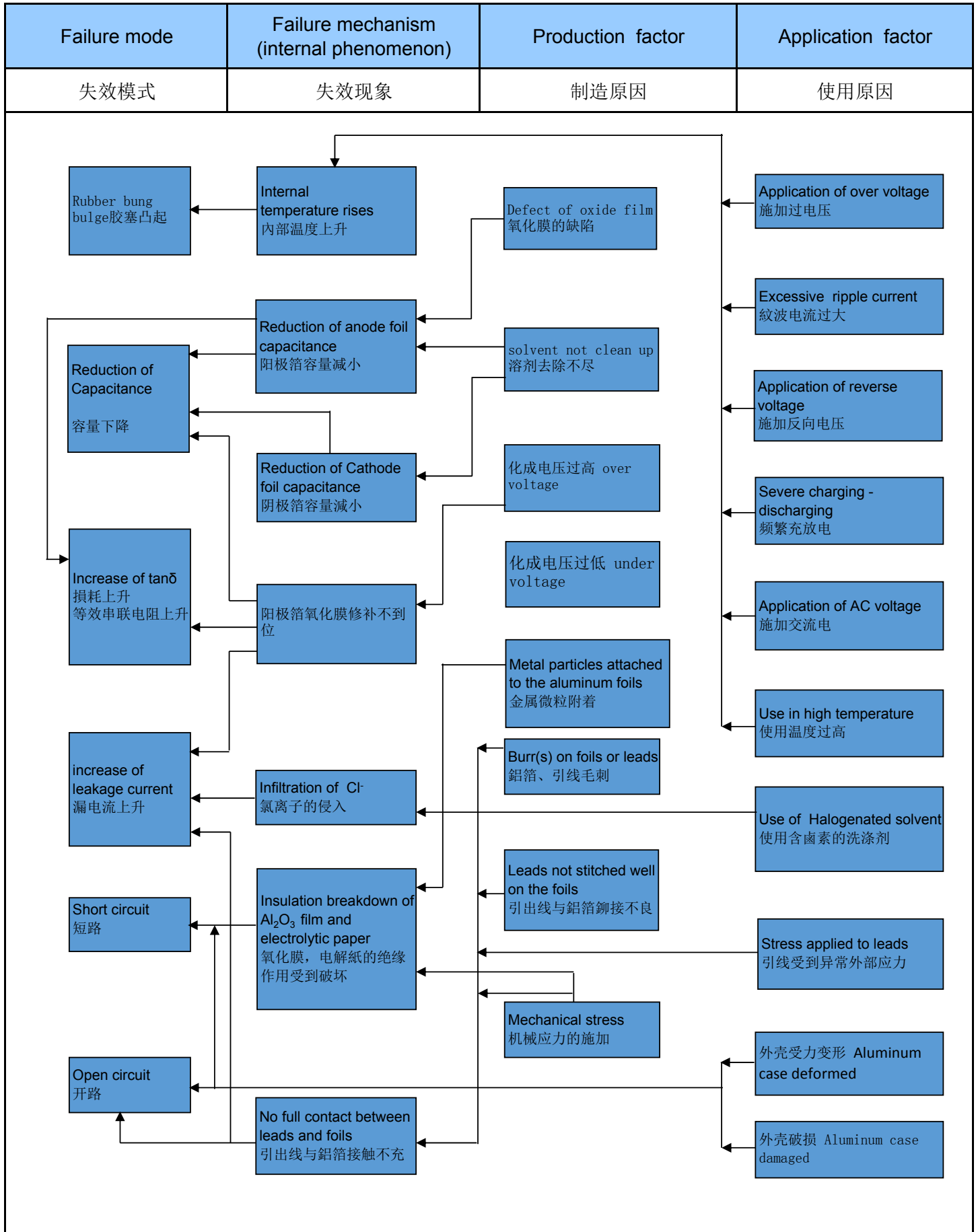



◆ 生产流程图

◆ Production Flow Chart

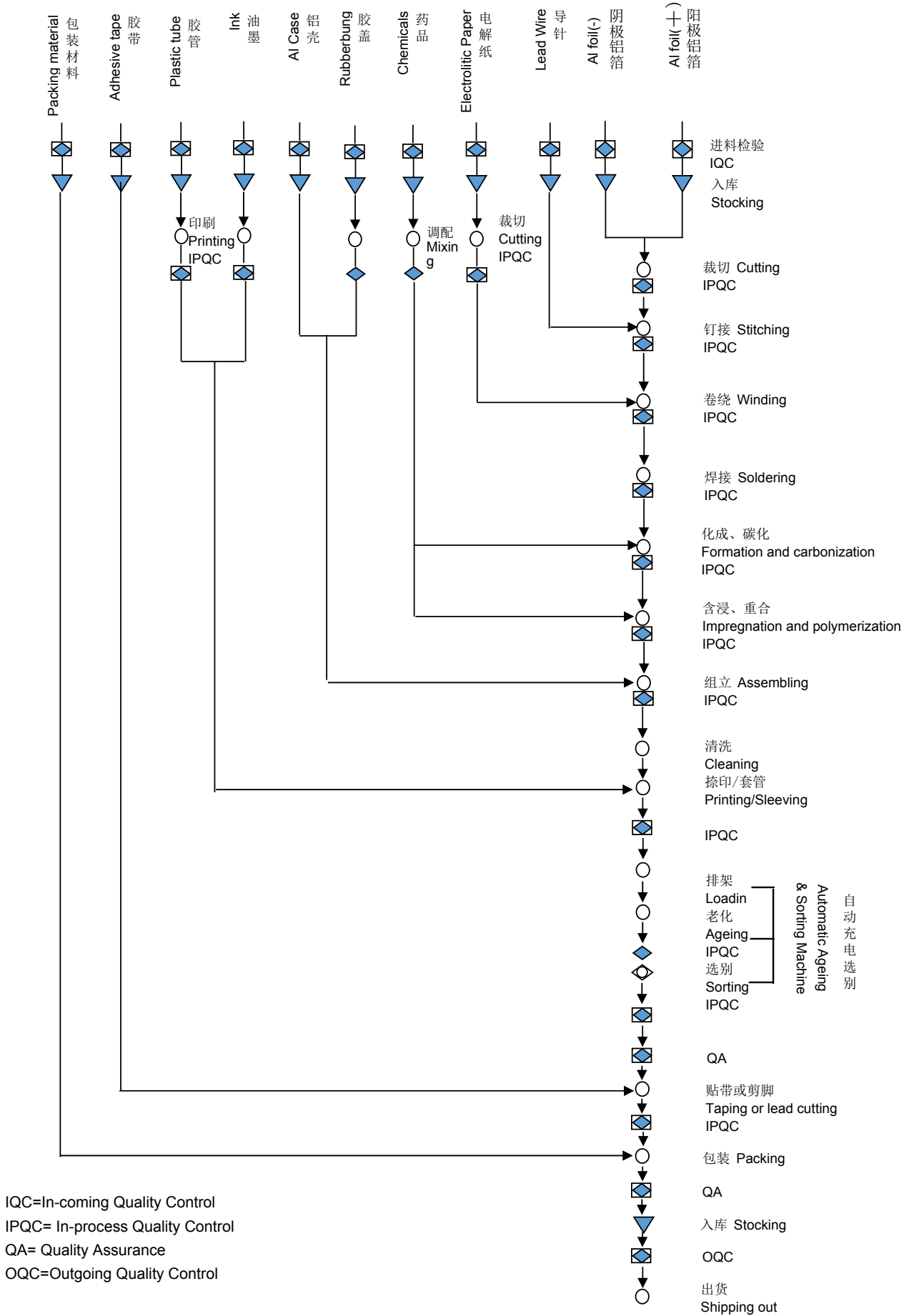



E1 Series

- Super low ESR, high ripple current
- Load life of 2000 hours at 105°C
- RoHS Compliant

◆ 规格表 Specifications

项目 Items	特性参数 Characteristics											
使用温度范围 Category Temperature Range	-55 ~ +105°C											
额定工作电压范围 Rated Voltage Range	2.5 ~ 25V											
静电容量允许偏差 Capacitance tolerance	±20%(M) (at 20°C, 120Hz)											
漏电流 Leakage Current	施加额定工作电压2分钟后读数, 小于或等于规格值 (at 20°C) I ≤ 0.2CV 或 500μA (取大值) Less than or equal to the specified value. After 2 minutes application of rated Voltage at 20°C											
损耗角正切值 tanδ Dissipation Factor	Rated voltage (V)	2.5	4	6.3	6.8	7.5	10	12	16	20	25	(at 20°C, 120Hz)
	tanδ (Max.)	0.08					0.12					
温度特性 Low Temperature Characteristics (Max. Impedance Ratio)	Z(-25°C)/Z(+20°C)	≤ 1.25					(100KHz)					
	Z(-55°C)/Z(+20°C)	≤ 1.25										
耐久性 Endurance	105°C 施加额定工作电压2000小时, 恢复到20°C后, 产品性能应满足以下要求 The specifications listed below shall be satisfied when the capacitors are restored to 20°C after application of rated voltage for 2000 hours at 105°C.											
	Appearance	No significant damage										
	Capacitance change	≤ ±20% of the initial value										
	D.F.(tanδ)	≤ 150% of the specified value										
	ESR	≤ 150% of the specified value										
	Leakage current	≤ The specified value										
耐湿负荷特性 Damp Heat (Steady State)	在60°C 温度, 湿度90%~95%RH的环境中, 施加额定电压1000小时后, 恢复到20°C后, 产品性能应满足以下要求 The specifications listed below shall be satisfied when the capacitors are restored to 20°C after application of rated voltage for 1000 hours at 60°C, 90%~95% RH.											
	Appearance	No significant damage										
	Capacitance change	≤ ±20% of the initial value										
	D.F.(tanδ)	≤ 150% of the specified value										
	ESR	≤ 150% of the specified value										
	Leakage current	≤ The specified value										
浪涌电压特性 (Surge Voltage)	浪涌电压=额定电压× 1.15(V) Surge Voltage=Rated voltage × 1.15(V) 在105°C环境中, 按充电30秒; 放电5分30秒, 连续施加浪涌电压1000次(Rc=1kΩ), 待恢复后测试, 应满足以下要求 The capacitors shall be subjected to 1000 cycles each consisting of charge with the surge voltages specified at 105°C for 30 seconds through a protective resistor (Rc=1kΩ) and discharge for 5 minutes 30 seconds											
	Appearance	No significant damage										
	Capacitance change	≤ ±20% of the initial value										
	D.F.(tanδ)	≤ 150% of the specified value										
	ESR	≤ 150% of the specified value										
	Leakage current	≤ The specified value										

◆ 外形图 Dimensions (mm)

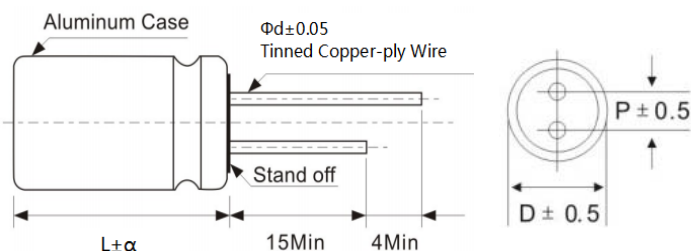

ΦD	5	6.3	8	10
P	2.0	2.5	3.5	5.0
Φd	0.5	0.6	0.6	0.6

α	(L < 16) 1.0
	(16 ≤ L < 22) 1.5
	(L ≥ 22) 2.0



E1 Series

◆ 纹波电流修正系数 Rated Ripple Current Coefficient

频率 Frequency(Hz)	120Hz \cong f < 1kHz	1kHz \cong f < 10kHz	10kHz \cong f < 100kHz	100kHz \cong f < 500kHz
系数 Coefficient	0.05	0.30	0.70	1.00

◆ 尺寸与个技术参数一览表 Standard Ratings

Rated voltage (V)	Rated capacitance (uF)	Case size $\Phi D \times L$ (mm)	ESR(m Ω) at 20°C, 100 KHz	Leakage Current (μ A)	Rated ripple current (mArms/105°C/100kHz)
2.5	560	5*8	12	500	4100
	560	6.3*8	8	500	5100
	680	6.3*8	8	500	5100
	680	8*9	8	500	5900
	820	6.3*8	8	500	5200
	820	8*9	8	500	5900
	1000	8*9	8	500	5900
	1000	8*12	8	500	6100
	1200	8*9	8	600	5900
	1200	8*12	8	600	6100
	1500	8*12	8	750	6100
4	560	6.3*8	8	500	5100
	560	8*9	8	500	5900
	680	6.3*8	8	544	5100
	680	8*9	8	544	5900
	820	6.3*9	8	656	5200
	820	8*9	8	656	5900
	1000	6.3*12	8	800	5500
	1000	8*9	8	800	5900
	1200	6.3*12	8	960	5500
	1200	8*9	8	960	5900
	6.3	220	5*8	12	500
270		5*8	12	500	3900
330		5*8	12	500	4100
330		6.3*8	10	500	4450
390		5*9	12	500	4510
390		6.3*8	10	500	4800
470		5*9	12	592	4510
470		6.3*8	8	592	4900
560		6.3*8	8	706	5100
560		8*9	8	706	5900
680		6.3*8	8	857	5100
680		8*9	8	857	5900



E1 Series

◆ 尺寸与个技术参数一览表 Standard Ratings

Rated voltage (V)	Rated capacitance (uF)	Case size ΦD×L(mm)	ESR(mΩ) at 20°C, 100 KHz	Leakage Current (μA)	Rated ripple current (mArms/105°C/100kHz)
6.3	820	6.3*9	8	1033	5200
	820	6.3*12	8	1033	5500
	820	8*9	8	1033	5900
	1000	6.3*12	8	1260	5500
	1000	8*9	8	1260	5900
	1000	8*12	8	1260	6100
	1200	8*9	8	1512	5900
	1200	8*12	8	1512	6100
	1500	8*12	8	1890	6100
	1500	10*12.5	8	1890	6200
	2200	10*12.5	8	2772	6200
	7.5	270	5*8	12	500
330		6.3*8	10	500	4100
390		6.3*8	10	585	4100
470		6.3*8	10	705	4100
560		6.3*8	10	840	4500
680		6.3*12	10	1020	4500
680		8*9	8	1020	4800
820		6.3*12	10	1230	4500
820		8*9	8	1230	4800
1000		8*9	8	1500	4800
1000		8*12	8	1500	5100
1200		8*12	8	1800	5100
1200		10*12.5	8	1800	5500
1500		10*12.5	8	2250	5500
10		220	5*8	15	500
	220	6.3*8	12	500	3500
	270	6.3*8	12	540	3500
	330	6.3*8	12	660	3750
	330	8*9	10	660	3800
	390	6.3*8	12	780	3750
	390	6.3*12	12	780	3900
	470	6.3*8	12	940	3850
	470	8*9	10	940	3950
	560	6.3*12	12	1120	3900
	560	8*9	10	1120	3950



E1 Series

◆ 尺寸与个技术参数一览表 Standard Ratings

Rated voltage (V)	Rated capacitance (uF)	Case size ΦD×L(mm)	ESR(mΩ) at 20°C, 100 KHz	Leakage Current (μA)	Rated ripple current (mArms/105°C/100kHz)
10	680	6.3*12	12	1360	4100
	680	8*9	10	1360	4200
	820	8*9	10	1640	4200
	820	8*12	8	1640	4500
	1000	8*12	8	2000	4500
	1000	10*12.5	8	2000	5200
	1200	10*12.5	8	2400	5200
	1500	10*12.5	8	3000	5200
12	220	5*9	15	528	2690
	220	6.3*8	13	528	2900
	270	6.3*8	13	648	2900
	330	6.3*8	13	792	2900
	390	6.3*8	13	936	2900
	470	6.3*12	13	1128	3500
	470	8*9	12	1128	3800
	560	6.3*12	13	1344	3500
	560	8*9	12	1344	3800
	680	8*9	12	1632	3800
	820	8*12	11	1968	4100
	1000	8*12	11	2400	4100
	1000	10*12.5	10	2400	4800
	1200	10*12.5	10	2880	4800
	1500	10*12.5	10	3600	4800
	16	100	5*8	15	500
150		5*8	15	500	2100
150		6.3*8	13	500	2900
180		5*9	15	576	2690
180		6.3*8	13	576	2900
220		6.3*8	13	704	2900
220		6.3*12	13	704	3500
220		8*9	12	704	3500
270		6.3*8	13	864	2900
270		8*9	12	864	3500
270		8*12	11	864	3790
330		6.3*8	13	1056	2900
330		6.3*12	13	1056	3500



E1 Series

◆ 尺寸与技术参数一览表 Standard Ratings

Rated voltage (V)	Rated capacitance (uF)	Case size $\Phi D \times L$ (mm)	ESR (m Ω) at 20°C, 100 KHz	Leakage Current (μA)	Rated ripple current (mA _{rms} /105°C/100kHz)
16	330	8*9	12	1056	3500
	470	6.3*12	13	1504	3500
	470	8*9	12	1504	3500
	560	6.3*12	13	1792	3500
	560	8*9	12	1792	3500
	680	8*12	11	2176	4800
	820	8*12	11	2624	4800
	1000	10*12.5	10	3200	5100
25	68	6.3*8	25	500	2100
	68	8*9	20	500	2690
	82	6.3*8	25	500	2100
	82	8*9	20	500	2690
	100	6.3*8	25	500	2100
	100	8*9	18	500	2690
	100	8*12	18	500	2900
	150	8*9	18	750	2690
	150	8*12	18	750	2900
	180	8*12	18	900	2900
	220	8*12	18	1100	2900
	270	10*12.5	15	1350	3500
	330	10*12.5	15	1650	3500
	470	10*12.5	15	2350	3500



E2 Series

- Low ESR, high ripple current
- Load life of 2000 hours at 105°C
- RoHS Compliant

规格表 Specifications

项目 Items	特性参数 Characteristics											
使用温度范围 Category Temperature Range	-55 ~ +105°C											
额定工作电压范围 Rated Voltage Range	2.5 ~ 25V											
静电容量允许偏差 Capacitance tolerance	±20%(M) (at 20°C, 120Hz)											
漏电流 Leakage Current	施加额定工作电压2分钟后读数, 小于或等于规格值 (at 20°C) I ≤ 0.2CV 或 500μA (取大值) Less than or equal to the specified value. After 2 minutes application of rated Voltage at 20°C											
损耗角正切值 tanδ Dissipation Factor	Rated voltage (V)	2.5	4	6.3	6.8	7.5	10	12	16	20	25	(at 20°C, 120Hz)
	tanδ (Max.)	0.08					0.12					
温度特性 Low Temperature Characteristics (Max.Impedance Ratio)	Z(-25°C)/Z(+20°C)	≤ 1.25					(100KHz)					
	Z(-55°C)/Z(+20°C)	≤ 1.25										
耐久性 Endurance	105°C施加额定工作电压2000小时, 恢复到20°C后, 产品性能应满足以下要求 The specifications listed below shall be satisfied when the capacitors are restored to 20°C after application of rated voltage for 2000 hours at 105°C.											
	Appearance	No significant damage										
	Capacitance change	≤ ±20% of the initial value										
	D.F.(tanδ)	≤ 150% of the specified value										
	ESR	≤ 150% of the specified value										
	Leakage current	≤ The specified value										
耐湿负荷特性 Damp Heat (Steady State)	在60°C 温度, 湿度90%~95%RH的环境中, 施加额定电压1000小时后, 恢复到20°C后, 产品性能应满足以下要求 The specifications listed below shall be satisfied when the capacitors are restored to 20°C after application of rated voltage for 1000 hours at 60°C, 90%~ 95% RH.											
	Appearance	No significant damage										
	Capacitance change	≤ ±20% of the initial value										
	D.F.(tanδ)	≤ 150% of the specified value										
	ESR	≤ 150% of the specified value										
	Leakage current	≤ The specified value										
浪涌电压特性 (Surge Voltage)	浪涌电压=额定电压× 1.15(V) Surge Voltage=Rated voltage × 1.15(V) 在105°C环境中, 按充电30秒; 放电5分30秒, 连续施加浪涌电压1000次(Rc=1kΩ), 待恢复后测试, 应满足以下要求 The capacitors shall be subjected to 1000 cycles each consisting of charge with the surge voltages specified at 105°C for 30 seconds through a protective resistor (Rc=1kΩ) and discharge for 5 minutes 30 seconds											
	Appearance	No significant damage										
	Capacitance change	≤ ±20% of the initial value										
	D.F.(tanδ)	≤ 150% of the specified value										
	ESR	≤ 150% of the specified value										
	Leakage current	≤ The specified value										

外形图 Dimensions (mm)

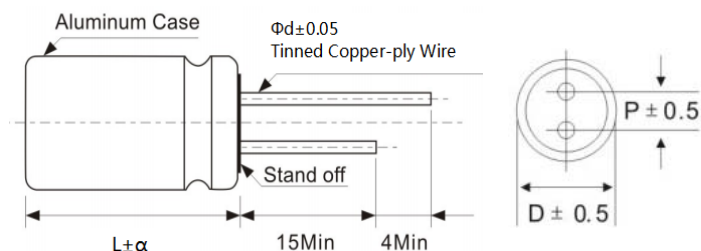

ΦD	5	6.3	8	10
P	2.0	2.5	3.5	5.0
Φd	0.5	0.6	0.6	0.6

α	(L < 16) 1.0
	(16 ≤ L < 22) 1.5
	(L ≥ 22) 2.0



E2 Series

◆ 纹波电流修正系数 Rated Ripple Current Coefficient

频率 Frequency(Hz)	120Hz \cong f < 1kHz	1kHz \cong f < 10kHz	10kHz \cong f < 100kHz	100kHz \cong f < 500kHz
系数 Coefficient	0.05	0.30	0.70	1.00

◆ 尺寸与技术参数一览表 Standard Ratings

Rated voltage (V)	Rated capacitance (μ F)	Case size Φ D×L(mm)	ESR($m\Omega$) at 20°C, 100 KHz	Leakage Current (μ A)	Rated ripple current (mA _{rms} /105°C/100kHz)
2.5	560	5*8	18	500	2900
	560	6.3*8	15	500	3500
	680	6.3*8	15	500	3500
	680	8*9	12	500	5200
	820	6.3*8	15	500	3500
	820	8*9	12	500	5200
	1000	8*9	12	500	5500
	1000	8*12	12	500	5500
	1200	8*9	12	600	5500
	1200	8*12	12	600	5500
	1500	8*12	12	750	5500
4	560	6.3*8	15	500	3100
	560	8*9	12	500	5100
	680	6.3*8	15	544	3500
	680	8*9	12	544	5100
	820	6.3*9	15	656	4100
	820	8*9	12	656	5100
	1000	6.3*12	15	800	4100
	1000	8*9	12	800	5100
	1200	6.3*12	15	960	4500
	1200	8*9	12	960	5100
	6.3	220	5*8	18	500
270		5*8	18	500	2690
330		5*8	18	500	2690
330		6.3*8	15	500	3100
390		5*9	16	500	3100
390		6.3*8	15	500	3100
470		5*9	15	592	3300
470		6.3*8	15	592	4100
560		6.3*8	15	706	4100
560		8*9	12	706	5100
680		6.3*8	15	857	4100
680		8*9	12	857	5100



E2 Series

◆ 尺寸与个技术参数一览表 Standard Ratings

Rated voltage (V)	Rated capacitance (uF)	Case size $\Phi D \times L$ (mm)	ESR(m Ω) at 20°C, 100 KHz	Leakage Current (μ A)	Rated ripple current (mA _{rms} /105°C/100kHz)
6.3	820	6.3*9	15	1033	4500
	820	6.3*12	15	1033	4800
	820	8*9	12	1033	5100
	1000	6.3*12	14	1260	4800
	1000	8*9	12	1260	5100
	1000	8*12	12	1260	5500
	1200	8*9	12	1512	5100
	1200	8*12	12	1512	5500
	1500	8*12	12	1890	5500
	1500	10*12.5	12	1890	5900
	2200	10*12.5	12	2772	5900
	7.5	270	5*8	18	500
330		6.3*8	16	500	3100
390		6.3*8	16	585	3500
470		6.3*8	16	705	3500
560		6.3*8	16	840	3500
680		6.3*12	16	1020	3800
680		8*9	12	1020	4800
820		6.3*12	16	1230	3800
820		8*9	12	1230	4800
1000		8*9	12	1500	4800
1000		8*12	12	1500	5100
1200		8*12	12	1800	5100
1200		10*12.5	12	1800	5500
1500		10*12.5	12	2250	5500
10		220	5*8	20	500
	220	6.3*8	16	500	2900
	270	6.3*8	16	540	2900
	330	6.3*8	16	660	3100
	330	8*9	14	660	4800
	390	6.3*8	16	780	3100
	390	6.3*12	16	780	3500
	470	6.3*8	16	940	3100
	470	8*9	14	940	4800
	560	6.3*12	16	1120	3500
	560	8*9	16	1120	4800



E2 Series

◆ 尺寸与个技术参数一览表 Standard Ratings

Rated voltage (V)	Rated capacitance (uF)	Case size ΦD×L(mm)	ESR(mΩ) at 20°C, 100 KHz	Leakage Current (μA)	Rated ripple current (mArms/105°C/100kHz)
10	680	6.3*12	16	1360	3500
	680	8*9	14	1360	4800
	820	8*9	14	1640	4800
	820	8*12	14	1640	5100
	1000	8*12	14	2000	5100
	1000	10*12.5	14	2000	5500
	1200	10*12.5	14	2400	5500
	1500	10*12.5	14	3000	5500
12	220	5*9	20	528	2690
	220	6.3*8	18	528	3160
	270	6.3*8	18	648	3160
	330	6.3*8	18	792	3200
	390	6.3*8	18	936	3200
	470	6.3*12	18	1128	3500
	470	8*9	15	1128	4100
	560	6.3*12	18	1344	3500
	560	8*9	15	1344	4100
	680	8*9	15	1632	4100
	820	8*12	15	1968	4500
	1000	8*12	15	2400	4500
	1000	10*12.5	12	2400	5200
	1200	10*12.5	12	2880	5200
	1500	10*12.5	12	3600	5200
	16	100	5*8	25	500
150		5*8	25	500	2100
150		6.3*8	20	500	2690
180		5*9	22	576	2690
180		6.3*8	20	576	2900
220		6.3*8	18	704	3100
220		6.3*12	18	704	3500
220		8*9	15	704	4100
270		6.3*8	18	864	3100
270		8*9	15	864	4100
270		8*12	15	864	4500
330		6.3*8	18	1056	3100
330		6.3*12	18	1056	4100



E2 Series

◆ 尺寸与个技术参数一览表Standard Ratings

Rated voltage (V)	Rated capacitance (uF)	Case size $\Phi D \times L$ (mm)	ESR(m Ω) at 20°C, 100 KHz	Leakage Current (μA)	Rated ripple current (mArms/105°C/100kHz)
16	330	8*9	15	1056	4100
	470	6.3*12	18	1504	3500
	470	8*9	15	1504	4100
	560	6.3*12	18	1792	3500
	560	8*9	15	1792	4100
	680	8*12	15	2176	4500
	820	8*12	15	2624	4500
	1000	10*12.5	14	3200	5200
	1500	10*12.5	14	4800	5200
25	68	6.3*8	40	500	2100
	68	8*9	30	500	3500
	82	6.3*8	40	500	2150
	82	8*9	30	500	3800
	100	6.3*8	40	500	2200
	100	8*9	30	500	3900
	100	8*12	25	500	4200
	220	6.3*12	35	1100	3800
	220	8*12	25	1100	4200
	330	6.3*12	35	1650	3800
	330	8*12	25	1650	4200
	560	8*12	25	2800	4200
	680	8*12	25	3400	4200
	820	10*12.5	20	4100	4800



E4 Series

- Low ESR, high ripple current, high temperature
- Load life of 2000 hours at 125°C
- RoHS Compliant

◆ 规格表 Specifications

项目 Items	特性参数 Characteristics											
使用温度范围 Category Temperature Range	-55 ~ +125°C											
额定工作电压范围 Rated Voltage Range	2.5 ~ 25V											
静电容量允许偏差 Capacitance tolerance	±20%(M) (at 20°C, 120Hz)											
漏电流 Leakage Current	施加额定工作电压2分钟后读数, 小于或等于规格值 (at 20°C) I ≤ 0.2CV 或 500μA (取大值) Less than or equal to the specified value. After 2 minutes application of rated Voltage at 20°C											
损耗角正切值 tanδ Dissipation Factor	Rated voltage (V)	2.5	4	6.3	6.8	7.5	10	12	16	20	25	(at 20°C, 120Hz)
	tanδ (Max.)	0.08					0.12					
温度特性 Low Temperature Characteristics (Max. Impedance Ratio)	Z(-25°C)/Z(+20°C)	≤ 1.25					(100KHz)					
	Z(-55°C)/Z(+20°C)	≤ 1.25										
耐久性 Endurance	125°C 施加额定工作电压2000小时, 恢复到20°C后, 产品性能应满足以下要求 The specifications listed below shall be satisfied when the capacitors are restored to 20°C after application of rated voltage for 2000 hours at 125°C.											
	Appearance	No significant damage										
	Capacitance change	≤ ±20% of the initial value										
	D.F.(tanδ)	≤ 150% of the specified value										
	ESR	≤ 150% of the specified value										
	Leakage current	≤ The specified value										
耐湿负荷特性 Damp Heat (Steady State)	在60°C 温度, 湿度90%~95%RH的环境中, 施加额定电压1000小时后, 恢复到20°C后, 产品性能应满足以下要求 The specifications listed below shall be satisfied when the capacitors are restored to 20°C after application of rated voltage for 1000 hours at 60°C, 90%~95% RH.											
	Appearance	No significant damage										
	Capacitance change	≤ ±20% of the initial value										
	D.F.(tanδ)	≤ 150% of the specified value										
	ESR	≤ 150% of the specified value										
	Leakage current	≤ The specified value										
浪涌电压特性 (Surge Voltage)	浪涌电压=额定电压× 1.15(V) Surge Voltage=Rated voltage × 1.15(V) 在125°C环境中, 按充电30秒; 放电5分30秒, 连续施加浪涌电压1000次(Rc=1kΩ), 待恢复后测试, 应满足以下要求 The capacitors shall be subjected to 1000 cycles each consisting of charge with the surge voltages specified at 125°C for 30 seconds through a protective resistor (Rc=1kΩ) and discharge for 5 minutes 30 seconds											
	Appearance	No significant damage										
	Capacitance change	≤ ±20% of the initial value										
	D.F.(tanδ)	≤ 150% of the specified value										
	ESR	≤ 150% of the specified value										
	Leakage current	≤ The specified value										

◆ 外形图 Dimensions (mm)

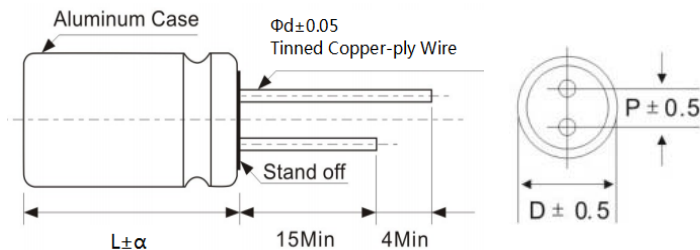

ΦD	5	6.3	8	10
P	2.0	2.5	3.5	5.0
Φd	0.5	0.6	0.6	0.6

α	(L < 16)1.0
	(16 ≤ L < 22)1.5
	(L ≥ 22)2.0



E4 Series

◆ 纹波电流修正系数 Rated Ripple Current Coefficient

频率 Frequency(Hz)	120Hz \cong f < 1kHz	1kHz \cong f < 10kHz	10kHz \cong f < 100kHz	100kHz \cong f < 500kHz
系数 Coefficient	0.05	0.30	0.70	1.00

◆ 尺寸与个技术参数一览表 Standard Ratings

Rated voltage (V)	Rated capacitance (uF)	Case size Φ D×L(mm)	ESR(m Ω) at 20°C, 100 KHz	Leakage Current (μ A)	Rated ripple current (mA _{rms} /125°C/100kHz)
2.5	560	6.3*8	10	500	1700
	680	6.3*8	10	500	1700
	820	8*9	10	500	1929
	1000	8*9	10	500	1929
	1000	8*12	10	500	1929
	1500	8*12	10	750	1929
	2200	10*12.5	9	1100	2100
4	560	6.3*8	12	500	1700
	560	8*9	10	500	1929
	680	6.3*8	12	544	1700
	680	8*9	10	544	1929
	820	8*9	10	656	1929
	1000	8*9	10	800	1929
	1000	8*12	10	800	1929
	1500	10*12.5	9	1200	2100
6.3	220	5*8	18	500	1500
	220	6.3*8	15	500	1700
	330	6.3*8	15	500	1700
	470	6.3*8	15	592	1700
	470	8*9	12	592	1929
	560	6.3*8	15	706	1700
	560	8*9	12	706	1929
	680	8*9	12	857	1929
	820	8*9	12	1033	1929
	1000	8*9	12	1260	1929
	1000	8*12	10	1260	1929
	1000	10*12.5	9	1260	2100
	1500	8*12	10	1890	1929
	1500	10*12.5	9	1890	2100
	2200	10*12.5	9	2772	2100
7.5	220	6.3*8	15	500	1700
	330	6.3*8	15	500	1700
	470	6.3*8	15	705	1700
	560	6.3*8	15	840	1700



E4 Series

◆ 尺寸与个技术参数一览表 Standard Ratings

Rated voltage (V)	Rated capacitance (uF)	Case size ΦD×L(mm)	ESR(mΩ) at 20°C, 100 KHz	Leakage Current (μA)	Rated ripple current (mArms/125°C/100kHz)
7.5	820	8*9	12	1230	1929
	820	8*12	10	1230	1929
	1000	8*12	10	1500	1929
	1000	10*12.5	9	1500	2100
	1500	10*12.5	9	2250	2100
10	220	6.3*8	16	500	1700
	330	6.3*8	16	660	1700
	470	8*9	14	940	1929
	560	8*9	14	1120	1929
	560	8*12	12	1120	1929
	680	8*12	12	1360	1929
	820	8*12	12	1640	1929
	820	10*12.5	10	1640	2100
	1000	10*12.5	10	2000	2100
16	100	6.3*8	18	500	920
	220	8*9	16	704	1500
	220	8*12	14	704	1770
	330	8*12	14	1056	1770
	330	10*12.5	12	1056	1929
	470	8*12	14	1504	1770
	470	10*12.5	12	1504	1929
	560	10*12.5	12	1792	1929
25	22	5*7	50	500	950
	100	6.3*8	40	500	1100
	220	6.3*12	35	1100	1310
	220	8*12	25	1100	1450
	330	8*12	25	1650	1450
	330	10*12.5	20	1650	1800
	470	10*12.5	20	2350	1800
	560	10*12.5	20	2800	1800
	680	10*12.5	20	3400	1800



E5 Series

- Low ESR, high ripple current, long life
- Load life of 5000 hours at 105°C
- RoHS Compliant

◆ 规格表 Specifications

项目 Items	特性参数 Characteristics											
使用温度范围 Category Temperature Range	-55 ~ +105°C											
额定工作电压范围 Rated Voltage Range	2.5 ~ 25V											
静电容量允许偏差 Capacitance tolerance	±20%(M) (at 20°C, 120Hz)											
漏电流 Leakage Current	施加额定工作电压2分钟后读数, 小于或等于规格值 (at 20°C) I ≤ 0.2CV 或 500μA (取大值) Less than or equal to the specified value. After 2 minutes application of rated Voltage at 20°C											
损耗角正切值 tanδ Dissipation Factor	Rated voltage (V)	2.5	4	6.3	6.8	7.5	10	12	16	20	25	(at 20°C, 120Hz)
	tanδ (Max.)	0.08					0.12					
温度特性 Low Temperature Characteristics (Max. Impedance Ratio)	Z(-25°C)/Z(+20°C)	≤ 1.25					(100KHz)					
	Z(-55°C)/Z(+20°C)	≤ 1.25										
耐久性 Endurance	105°C 施加额定工作电压5000小时, 恢复到20°C后, 产品性能应满足以下要求 The specifications listed below shall be satisfied when the capacitors are restored to 20°C after application of rated voltage for 5000 hours at 105°C.											
	Appearance	No significant damage										
	Capacitance change	≤ ±20% of the initial value										
	D.F.(tanδ)	≤ 150% of the specified value										
	ESR	≤ 150% of the specified value										
	Leakage current	≤ The specified value										
耐湿负荷特性 Damp Heat (Steady State)	在60°C 温度, 湿度90%~95%RH的环境中, 施加额定电压1000小时后, 恢复到20°C后, 产品性能应满足以下要求 The specifications listed below shall be satisfied when the capacitors are restored to 20°C after application of rated voltage for 1000 hours at 60°C, 90%~95% RH.											
	Appearance	No significant damage										
	Capacitance change	≤ ±20% of the initial value										
	D.F.(tanδ)	≤ 150% of the specified value										
	ESR	≤ 150% of the specified value										
	Leakage current	≤ The specified value										
浪涌电压特性 (Surge Voltage)	浪涌电压=额定电压× 1.15(V) Surge Voltage=Rated voltage × 1.15(V) 在105°C环境中, 按充电30秒; 放电5分30秒, 连续施加浪涌电压1000次(Rc=1kΩ), 待恢复后测试, 应满足以下要求 The capacitors shall be subjected to 1000 cycles each consisting of charge with the surge voltages specified at 105°C for 30 seconds through a protective resistor (Rc=1kΩ) and discharge for 5 minutes 30 seconds											
	Appearance	No significant damage										
	Capacitance change	≤ ±20% of the initial value										
	D.F.(tanδ)	≤ 150% of the specified value										
	ESR	≤ 150% of the specified value										
	Leakage current	≤ The specified value										

◆ 外形图 Dimensions (mm)

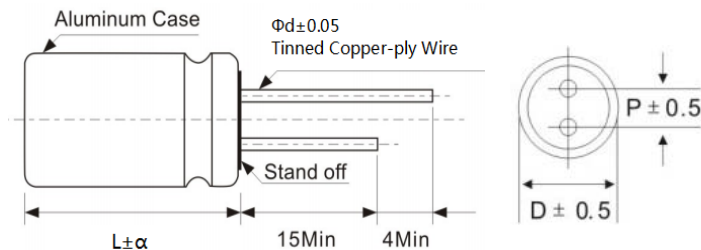

ΦD	5	6.3	8	10
P	2.0	2.5	3.5	5.0
Φd	0.5	0.6	0.6	0.6

α	(L < 16) 1.0
	(16 ≤ L < 22) 1.5
	(L ≥ 22) 2.0



E5 Series

◆ 纹波电流修正系数 Rated Ripple Current Coefficient

频率 Frequency(Hz)	120Hz \cong f < 1kHz	1kHz \cong f < 10kHz	10kHz \cong f < 100kHz	100kHz \cong f < 500kHz
系数 Coefficient	0.05	0.30	0.70	1.00

◆ 尺寸与个技术参数一览表 Standard Ratings

Rated voltage (V)	Rated capacitance (uF)	Case size Φ D×L(mm)	ESR(m Ω) at 20°C, 100 KHz	Leakage Current (μ A)	Rated ripple current (mArms/105°C/100kHz)
2.5	560	5*8	15	500	2900
	560	6.3*8	15	500	3500
	680	6.3*8	15	500	3500
	680	8*9	12	500	5200
	820	6.3*8	15	500	3500
	820	8*9	12	500	5200
	1000	8*9	12	500	5500
	1000	8*12	12	500	5500
	1200	8*9	12	600	5500
	1200	8*12	12	600	5500
	1500	8*12	12	750	5500
4	560	6.3*8	15	500	3100
	560	8*9	12	500	5100
	680	6.3*8	15	544	3500
	680	8*9	12	544	5100
	820	6.3*9	15	656	4100
	820	8*9	12	656	5100
	1000	6.3*12	15	800	4100
	1000	8*9	12	800	5100
	1200	6.3*12	15	960	4500
	1200	8*9	12	960	5100
	6.3	220	5*8	15	500
270		5*8	15	500	2690
330		5*8	15	500	2690
330		6.3*8	15	500	3100
390		5*9	15	500	3100
390		6.3*8	15	500	3100
470		5*9	15	592	3300
470		6.3*8	15	592	4100
560		6.3*8	15	706	4100
560		8*9	12	706	5100
680		6.3*8	15	857	4100
680		8*9	12	857	5100



E5 Series

◆ 尺寸与个技术参数一览表 Standard Ratings

Rated voltage (V)	Rated capacitance (uF)	Case size ΦD×L(mm)	ESR(mΩ) at 20°C, 100 KHz	Leakage Current (μA)	Rated ripple current (mArms/105°C/100kHz)
6.3	820	6.3*9	15	1033	4500
	820	6.3*12	15	1033	4800
	820	8*9	12	1033	5100
	1000	6.3*12	14	1260	4800
	1000	8*9	12	1260	5100
	1000	8*12	12	1260	5500
	1200	8*9	12	1512	5100
	1200	8*12	12	1512	5500
	1500	8*12	12	1890	5500
	1500	10*12.5	12	1890	5900
	2200	10*12.5	12	2772	5900
7.5	270	5*8	18	500	2690
	330	6.3*8	16	500	3100
	390	6.3*8	16	585	3500
	470	6.3*8	16	705	3500
	560	6.3*8	16	840	3500
	680	6.3*12	16	1020	3800
	680	8*9	12	1020	4800
	820	6.3*12	16	1230	3800
	820	8*9	12	1230	4800
	1000	8*9	12	1500	4800
	1000	8*12	12	1500	5100
	1200	8*12	12	1800	5100
	1200	10*12.5	12	1800	5500
	1500	10*12.5	12	2250	5500
10	220	5*8	20	500	2200
	220	6.3*8	16	500	2900
	270	6.3*8	16	540	2900
	330	6.3*8	16	660	3100
	330	8*9	14	660	4800
	390	6.3*8	16	780	3100
	390	6.3*12	16	780	3500
	470	6.3*8	16	940	3100
	470	8*9	14	940	4800
	560	6.3*12	16	1120	3500
	560	8*9	16	1120	4800



E5 Series

◆ 尺寸与个技术参数一览表 Standard Ratings

Rated voltage (V)	Rated capacitance (uF)	Case size ΦD×L(mm)	ESR(mΩ) at 20°C, 100 KHz	Leakage Current (μA)	Rated ripple current (mArms/105°C/100kHz)
10	680	6.3*12	16	1360	3500
	680	8*9	14	1360	4800
	820	8*9	14	1640	4800
	820	8*12	14	1640	5100
	1000	8*12	14	2000	5100
	1000	10*12.5	14	2000	5500
	1200	10*12.5	14	2400	5500
	1500	10*12.5	14	3000	5500
12	220	5*9	20	528	2690
	220	6.3*8	18	528	3160
	270	6.3*8	18	648	3160
	330	6.3*8	18	792	3200
	390	6.3*8	18	936	3200
	470	6.3*12	18	1128	3500
	470	8*9	15	1128	4100
	560	6.3*12	18	1344	3500
	560	8*9	15	1344	4100
	680	8*9	15	1632	4100
	820	8*12	15	1968	4500
	1000	8*12	15	2400	4500
	1000	10*12.5	12	2400	5200
	1200	10*12.5	12	2880	5200
	1500	10*12.5	12	3600	5200
	16	100	5*8	25	500
150		5*8	25	500	2100
150		6.3*8	20	500	2690
180		5*9	22	576	2690
180		6.3*8	20	576	2900
220		6.3*8	18	704	3100
220		6.3*12	18	704	3500
220		8*9	15	704	4100
270		6.3*8	18	864	3100
270		8*9	15	864	4100
270		8*12	15	864	4500
330		6.3*8	18	1056	3100
330		6.3*12	18	1056	4100



E5 Series

◆ 尺寸与技术参数一览表 Standard Ratings

Rated voltage (V)	Rated capacitance (uF)	Case size $\Phi D \times L$ (mm)	ESR (m Ω) at 20°C, 100 KHz	Leakage Current (μA)	Rated ripple current (mA _{rms} /105°C/100kHz)
16	330	8*9	15	1056	4100
	470	6.3*11	18	1504	3500
	470	8*9	15	1504	4100
	560	6.3*11	18	1792	3500
	560	8*9	15	1792	4100
	680	8*12	15	2176	4500
	820	8*12	15	2624	4500
	1000	10*12.5	14	3200	5200
25	68	6.3*8	30	500	2100
	68	8*9	25	500	3500
	82	6.3*8	30	500	2150
	82	8*9	20	500	3800
	100	6.3*8	30	500	2200
	100	8*9	20	500	3900
	100	8*12	20	500	4200
	150	8*9	20	750	3900
	150	8*12	20	750	4200
	180	8*12	20	900	4200
	220	8*12	20	1100	4200
	270	10*12.5	18	1350	4800
	330	10*12.5	18	1650	4800
	470	10*12.5	18	2350	4800



H2 Series

- Low ESR, high ripple current, high voltage
- Load life of 2000 hours at 105°C
- RoHS Compliant

◆ 规格表 Specifications

项目 Items	特性参数 Characteristics		
使用温度范围 Category Temperature Range	-55 ~ +105°C		
额定工作电压范围 Rated Voltage Range	35 ~ 100V		
静电容量允许偏差 Capacitance tolerance	±20%(M) (at 20°C, 120Hz)		
漏电流 Leakage Current	施加额定工作电压2分钟后读数, 小于或等于规格值 (at 20°C) I ≤ 0.1CV 或 299μA (取大值) Less than or equal to the specified value. After 2 minutes application of rated Voltage at 20°C		
损耗角正切值 tanδ Dissipation Factor	Rated voltage (V)	35~100	(at 20°C, 120Hz)
	tanδ (Max.)	0.12	
温度特性 Low Temperature Characteristics (Max.Impedance Ratio)	Z(-25°C)/Z(+20°C)	≤ 1.25	(100KHz)
	Z(-55°C)/Z(+20°C)	≤ 1.25	
耐久性 Endurance	105°C施加额定工作电压2000小时, 恢复到20°C后, 产品性能应满足以下要求 The specifications listed below shall be satisfied when the capacitors are restored to 20°C after application of rated voltage for 2000 hours at 105°C.		
	Appearance	No significant damage	
	Capacitance change	≤ ±20% of the initial value	
	D.F.(tanδ)	≤ 150% of the specified value	
	ESR	≤ 150% of the specified value	
	Leakage current	≤ The specified value	
耐湿负荷特性 Damp Heat (Steady State)	在60°C 温度, 湿度90%~95%RH的环境中, 施加额定电压1000小时后, 恢复到20°C后, 产品性能应满足以下要求 The specifications listed below shall be satisfied when the capacitors are restored to 20°C after application of rated voltage for 1000 hours at 60°C, 90%~ 95% RH.		
	Appearance	No significant damage	
	Capacitance change	≤ ±20% of the initial value	
	D.F.(tanδ)	≤ 150% of the specified value	
	ESR	≤ 150% of the specified value	
	Leakage current	≤ The specified value	
浪涌电压特性 (Surge Voltage)	浪涌电压=额定电压× 1.15(V) Surge Voltage=Rated voltage × 1.15(V) 在105°C环境中, 按充电30秒; 放电5分30秒, 连续施加浪涌电压1000次(Rc=1kΩ), 待恢复后测试, 应满足以下要求 The capacitors shall be subjected to 1000 cycles each consisting of charge with the surge voltages specified at 105°C for 30 seconds through a protective resistor (Rc=1kΩ) and discharge for 5 minutes 30 seconds		
	Appearance	No significant damage	
	Capacitance change	≤ ±20% of the initial value	
	D.F.(tanδ)	≤ 150% of the specified value	
	ESR	≤ 150% of the specified value	
	Leakage current	≤ The specified value	

◆ 外形图 Dimensions (mm)

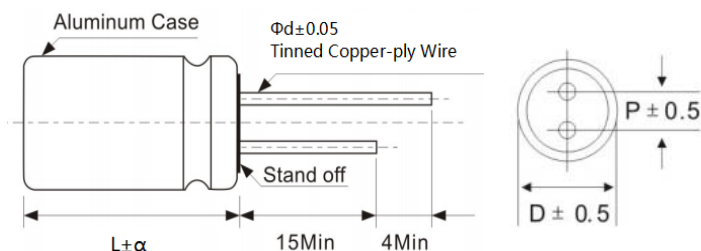

ΦD	5	6.3	8	10
P	2.0	2.5	3.5	5.0
Φd	0.5	0.6	0.6	0.6

α	(L < 16)1.0
	(16 ≤ L < 22)1.5
	(L ≥ 22)2.0



H2 Series

◆ 纹波电流修正系数 Rated Ripple Current Coefficient

频率 Frequency(Hz)	120Hz \leq f < 1kHz	1kHz \leq f < 10kHz	10kHz \leq f < 100kHz	100kHz \leq f < 500kHz
系数 Coefficient	0.05	0.30	0.70	1.00

◆ 尺寸与个技术参数一览表 Standard Ratings

Rated voltage (V)	Rated capacitance (μ F)	Case size Φ D×L(mm)	ESR($m\Omega$) at 20°C, 100 KHz	Leakage Current (μ A)	Rated ripple current (mA rms/105°C/100kHz)
35	10	5*8	120	299	1100
	22	6.3*8	100	299	1350
	33	5*8	120	299	1100
	39	6.3*8	90	299	1350
	39	8*9	60	299	1800
	47	6.3*8	80	299	1350
	47	8*9	60	299	1800
	56	6.3*8	80	299	1350
	56	8*9	60	299	1800
	68	6.3*8	70	299	1500
	68	8*9	50	299	2000
	82	6.3*11	60	299	1800
	82	8*9	40	299	2000
	100	8*9	40	350	2000
	150	8*12	35	525	2500
	220	8*12	35	770	2500
330	10*12.5	30	1155	2900	
470	10*12.5	30	1645	2900	
50	10	5*8	120	299	550
	15	6.3*8	100	299	800
	22	6.3*8	100	299	850
	33	8*9	50	299	1300
	33	8*12	40	299	1500
	39	8*9	50	299	1300
	39	8*12	40	299	1500
	47	8*12	40	299	1500
	56	8*12	40	299	1500
	82	10*12.5	35	410	2100
	100	10*12.5	35	500	2100



H2 Series

◆ 尺寸与个技术参数一览表 Standard Ratings

Rated voltage (V)	Rated capacitance (uF)	Case size $\Phi D \times L$ (mm)	ESR (m Ω) at 20°C, 100 KHz	Leakage Current (μ A)	Rated ripple current (mA _{rms} /105°C/100kHz)
63	10	5*8	120	299	500
	15	6.3*8	100	299	750
	22	6.3*8	100	299	750
	33	8*9	55	299	1100
	39	8*9	55	299	1100
	47	8*12	45	299	1300
	56	8*12	45	353	1300
	82	10*12.5	38	517	1800
	100	10*12.5	38	630	1800
80	10	6.3*8	120	299	550
	15	6.3*8	120	299	550
	22	8*9	80	299	1100
	22	8*12	60	299	1300
	33	10*12.5	45	299	1700
	39	10*12.5	45	312	1700
	47	10*12.5	45	376	1800
	56	10*12.5	45	448	1800
100	10	8*9	90	299	850
	15	8*12	70	299	1190
	22	10*12.5	60	299	1550
	33	10*12.5	60	330	1550



H4 Series

- Low ESR, high ripple current, high voltage, high temperature
- Load life of 2000 hours at 125°C
- RoHS Compliant

◆ 规格表 Specifications

项目 Items	特性参数 Characteristics		
使用温度范围 Category Temperature Range	-55 ~ +125°C		
额定工作电压范围 Rated Voltage Range	35 ~ 100V		
静电容量允许偏差 Capacitance tolerance	±20%(M) (at 20°C, 120Hz)		
漏电流 Leakage Current	施加额定工作电压2分钟后读数, 小于或等于规格值 (at 20°C) I ≤ 0.1CV 或 299μA (取大值) Less than or equal to the specified value. After 2 minutes application of rated Voltage at 20°C		
损耗角正切值 tanδ Dissipation Factor	Rated voltage (V)	35~100	(at 20°C, 120Hz)
	tanδ (Max.)	0.12	
温度特性 Low Temperature Characteristics (Max.Impedance Ratio)	Z(-25°C)/Z(+20°C)	≤ 1.25	(100KHz)
	Z(-55°C)/Z(+20°C)	≤ 1.25	
耐久性 Endurance	125°C施加额定工作电压2000小时, 恢复到20°C后, 产品性能应满足以下要求 The specifications listed below shall be satisfied when the capacitors are restored to 20°C after application of rated voltage for 2000 hours at 125°C.		
	Appearance	No significant damage	
	Capacitance change	≤ ±20% of the initial value	
	D.F.(tanδ)	≤ 150% of the specified value	
	ESR	≤ 150% of the specified value	
	Leakage current	≤ The specified value	
耐湿负荷特性 Damp Heat (Steady State)	在60°C 温度, 湿度90%~95%RH的环境中, 施加额定电压1000小时后, 恢复到20°C后, 产品性能应满足以下要求 The specifications listed below shall be satisfied when the capacitors are restored to 20°C after application of rated voltage for 1000 hours at 60°C, 90%~ 95% RH.		
	Appearance	No significant damage	
	Capacitance change	≤ ±20% of the initial value	
	D.F.(tanδ)	≤ 150% of the specified value	
	ESR	≤ 150% of the specified value	
	Leakage current	≤ The specified value	
浪涌电压特性 (Surge Voltage)	浪涌电压=额定电压× 1.15(V) Surge Voltage=Rated voltage × 1.15(V) 在125°C环境中, 按充电30秒; 放电5分30秒, 连续施加浪涌电压1000次(Rc=1kΩ), 待恢复后测试, 应满足以下要求 The capacitors shall be subjected to 1000 cycles each consisting of charge with the surge voltages specified at 125°C for 30 seconds through a protective resistor (Rc=1kΩ) and discharge for 5 minutes 30 seconds		
	Appearance	No significant damage	
	Capacitance change	≤ ±20% of the initial value	
	D.F.(tanδ)	≤ 150% of the specified value	
	ESR	≤ 150% of the specified value	
	Leakage current	≤ The specified value	

◆ 外形图 Dimensions (mm)

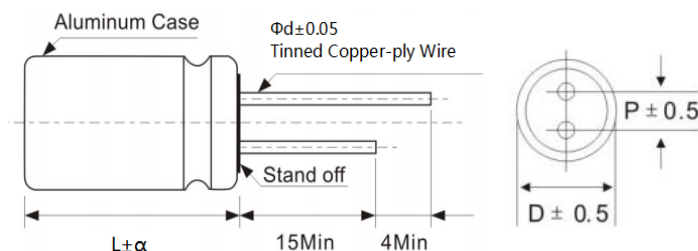

ΦD	5	6.3	8	10
P	2.0	2.5	3.5	5.0
Φd	0.5	0.6	0.6	0.6

α	(L < 16) 1.0
	(16 ≤ L < 22) 1.5
	(L ≥ 22) 2.0



H4 Series

◆ 纹波电流修正系数 Rated Ripple Current Coefficient

频率 Frequency(Hz)	120Hz \cong f < 1kHz	1kHz \cong f < 10kHz	10kHz \cong f < 100kHz	100kHz \cong f < 500kHz
系数 Coefficient	0.05	0.30	0.70	1.00

◆ 尺寸与个技术参数一览表 Standard Ratings

Rated voltage (V)	Rated capacitance (μ F)	Case size Φ D×L(mm)	ESR($m\Omega$) at 20°C, 100 KHz	Leakage Current (μ A)	Rated ripple current (mA _{rms} /125°C/100kHz)
35	10	5*8	120	299	630
	22	6.3*8	100	299	800
	33	6.3*8	100	299	630
	100	6.3*12	60	350	1040
	100	8*9	40	350	1150
	150	8*12	35	525	1440
	220	10*12.5	30	770	1700
	330	10*12.5	30	1155	1700
50	10	5*8	120	299	400
	22	6.3*8	100	299	500
	47	6.3*12	60	299	750
	47	8*12	40	299	860
	82	8*12	40	410	860
	100	10*12.5	35	500	1210
	220	10*12.5	35	1100	1210
63	10	6.3*8	100	299	400
	22	6.3*8	100	299	400
	47	8*9	55	299	630
	47	8*12	40	299	750
	100	10*12.5	38	630	1040
80	10	8*9	80	299	630
	22	8*12	60	299	750
	33	10*12.5	45	299	970
	47	10*12.5	45	299	1040
	56	10*12.5	45	448	1040
100	10	8*9	90	299	550
	15	8*12	70	299	680
	22	10*12.5	60	299	900
	33	10*12.5	60	330	900



H5 Series

- Low ESR, high ripple current, high voltage, long life
- Load life of 5000 hours at 105°C
- RoHS Compliant

◆ 规格表 Specifications

项目 Items	特性参数 Characteristics	
使用温度范围 Category Temperature Range	-55 ~ +105°C	
额定工作电压范围 Rated Voltage Range	35 ~ 100V	
静电容量允许偏差 Capacitance tolerance	±20%(M) (at 20°C,120Hz)	
漏电流 Leakage Current	施加额定工作电压2分钟后读数, 小于或等于规格值 (at 20°C) I≤0.1CV 或299μA (取大值) Less than or equal to the specified value. After 2 minutes application of rated Voltage at 20°C	
损耗角正切值tanδ Dissipation Factor	Rated voltage (V)	35~100
	tanδ (Max.)	0.12
温度特性 Low Temperature Characteristics (Max.Impedance Ratio)	Z(-25°C)/Z(+20°C)	≤ 1.25
	Z(-55°C)/Z(+20°C)	≤ 1.25
耐久性 Endurance	105°C施加额定工作电压5000小时, 恢复到20°C后, 产品性能应满足以下要求 The specifications listed below shall be satisfied when the capacitors are restored to 20°C after application of rated voltage for 5000 hours at 105°C.	
	Appearance	No significant damage
	Capacitance change	≤±20% of the initial value
	D.F.(tanδ)	≤ 150% of the specified value
	ESR	≤ 150% of the specified value
	Leakage current	≤ The specified value
耐湿负荷特性 Damp Heat (Steady State)	在60°C 温度, 湿度90%~95%RH的环境中, 施加额定电压1000小时后, 恢复到20°C后, 产品性能应满足以下要求 The specifications listed below shall be satisfied when the capacitors are restored to 20°C after application of rated voltage for 1000 hours at 60°C, 90%~ 95% RH.	
	Appearance	No significant damage
	Capacitance change	≤±20% of the initial value
	D.F.(tanδ)	≤ 150% of the specified value
	ESR	≤ 150% of the specified value
	Leakage current	≤ The specified value
浪涌电压特性 (Surge Voltage)	浪涌电压=额定电压× 1.15(V) Surge Voltage=Rated voltage × 1.15(V) 在105°C环境中, 按充电30秒; 放电5分30秒, 连续施加浪涌电压1000次(Rc=1kΩ), 待恢复后测试, 应满足以下要求 The capacitors shall be subjected to 1000 cycles each consisting of charge with the surge voltages specified at 105°C for 30 seconds through a protective resistor (Rc=1kΩ) and discharge for 5 minutes 30 seconds	
	Appearance	No significant damage
	Capacitance change	≤±20% of the initial value
	D.F.(tanδ)	≤ 150% of the specified value
	ESR	≤ 150% of the specified value
	Leakage current	≤ The specified value

◆ 外形图Dimensions (mm)

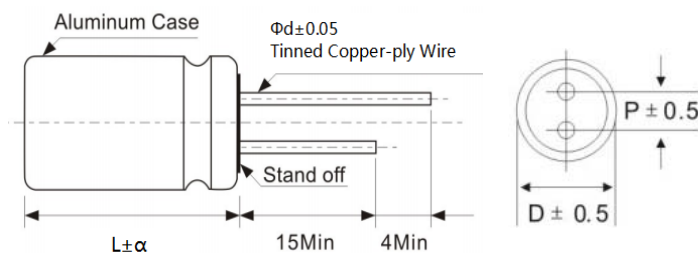

ΦD	5	6.3	8	10
P	2.0	2.5	3.5	5.0
Φd	0.5	0.6	0.6	0.6

α	(L < 16)1.0
	(16 ≤ L < 22)1.5
	(L ≥ 22)2.0



H5 Series

◆ 纹波电流修正系数 Rated Ripple Current Coefficient

频率 Frequency(Hz)	120Hz \cong f < 1kHz	1kHz \cong f < 10kHz	10kHz \cong f < 100kHz	100kHz \cong f < 500kHz
系数 Coefficient	0.05	0.30	0.70	1.00

◆ 尺寸与个技术参数一览表 Standard Ratings

Rated voltage (V)	Rated capacitance (μ F)	Case size Φ D×L(mm)	ESR($m\Omega$) at 20°C, 100 KHz	Leakage Current (μ A)	Rated ripple current (mA _{rms} /105°C/100kHz)
35	10	5*8	120	299	1100
	22	6.3*8	100	299	1350
	33	5*8	120	299	1100
	39	6.3*8	90	299	1350
	39	8*9	60	299	1800
	47	6.3*8	80	299	1350
	47	8*9	60	299	1800
	56	6.3*8	80	299	1350
	56	8*9	60	299	1800
	68	6.3*8	70	299	1500
	68	8*9	50	299	2000
	82	6.3*11	60	299	1800
	82	8*9	40	299	2000
	100	8*9	40	350	2000
	150	8*12	35	525	2500
	220	10*12.5	30	770	2900
330	10*12.5	30	1155	2900	
50	10	5*8	120	299	550
	15	6.3*8	100	299	800
	22	6.3*8	100	299	850
	33	8*9	50	299	1300
	33	8*12	40	299	1500
	39	8*9	50	299	1300
	39	8*12	40	299	1500
	47	8*12	40	299	1500
	56	8*12	40	299	1500
	82	10*12.5	35	410	2100
	100	10*12.5	35	500	2100



H5 Series

◆ 尺寸与技术参数一览表 Standard Ratings

Rated voltage (V)	Rated capacitance (uF)	Case size $\Phi D \times L$ (mm)	ESR ($m\Omega$) at 20°C, 100 KHz	Leakage Current (μA)	Rated ripple current (mA _{rms} /105°C/100kHz)
63	10	5*8	120	299	500
	15	6.3*8	100	299	750
	22	6.3*8	100	299	750
	33	8*9	55	299	1100
	39	8*9	55	299	1100
	47	8*12	45	299	1300
	56	8*12	45	353	1300
	82	10*12.5	38	517	1800
	100	10*12.5	38	630	1800
80	10	6.3*8	120	299	550
	15	6.3*8	120	299	550
	22	8*9	80	299	1100
	22	8*12	60	299	1300
	33	10*12.5	45	299	1700
	39	10*12.5	45	312	1700
	47	10*12.5	45	376	1800
	56	10*12.5	45	448	1800
100	10	8*9	90	299	850
	15	8*12	70	299	1190
	22	10*12.5	60	299	1550
	33	10*12.5	60	330	1550



M1 Series

- Super low ESR, High ripple, miniaturized
- SMD type: lead free reflow soldering condition at 260°C peak correspondence
- RoHS Compliant

规格表 Specifications

项目 Items	特性参数 Characteristics		
使用温度范围 Category Temperature Range	-55 ~ +105°C		
额定工作电压范围 Rated Voltage Range	2.5 ~ 100V		
静电容量允许偏差 Capacitance tolerance	±20%(M) (at 20°C, 120Hz)		
漏电流 Leakage Current	施加额定工作电压2分钟后读数, 小于或等于规格值 (at 20°C) Less than or equal to the specified value. After 2 minutes application of rated Voltage at 20°C		2.5~25V
			35~100V I≤0.1CV 或 299µA(取大值)
损耗角正切值tanδ Dissipation Factor	Rated voltage (V)	2.5~6.3	10~100
	tanδ (Max.)	0.08	0.12
温度特性 Low Temperature Characteristics (Max.Impedance Ratio)	Z(-25°C)/Z(+20°C)	≤ 1.25	
	Z(-55°C)/Z(+20°C)	≤ 1.25	
耐久性 Endurance	105°C施加额定工作电压2000小时, 恢复到20°C后, 产品性能应满足以下要求 The specifications listed below shall be satisfied when the capacitors are restored to 20°C after application of rated voltage for 2000 hours at 105°C.		
	Appearance	No significant damage	
	Capacitance change	≤ ±20% of the initial value	
	D.F.(tanδ)	≤ 150% of the specified value	
	ESR	≤ 150% of the specified value	
	Leakage current	≤ The specified value	
耐湿负荷特性 Damp Heat (Steady State)	在60°C 温度, 湿度90%~95%RH的环境中, 施加额定电压1000小时后, 恢复到20°C后, 产品性能应满足以下要求 The specifications listed below shall be satisfied when the capacitors are restored to 20°C after application of rated voltage for 1000 hours at 60°C, 90%~ 95% RH.		
	Appearance	No significant damage	
	Capacitance change	≤ ±20% of the initial value	
	D.F.(tanδ)	≤ 150% of the specified value	
	ESR	≤ 150% of the specified value	
	Leakage current	≤ The specified value	
浪涌电压特性 (Surge Voltage)	浪涌电压=额定电压× 1.15(V) Surge Voltage=Rated voltage × 1.15(V) 在105°C环境中, 按充电30秒; 放电5分30秒, 连续施加浪涌电压1000次(Rc=1kΩ), 待恢复测试, 应满足以下要求 The capacitors shall be subjected to 1000 cycles each consisting of charge with the surge voltages specified at 105°C for 30 seconds through a protective resistor (Rc=1kΩ) and discharge for 5 minutes 30 seconds.		
	Appearance	No significant damage	
	Capacitance change	≤ ±20% of the initial value	
	D.F.(tanδ)	≤ 150% of the specified value	
	ESR	≤ 150% of the specified value	
	Leakage current	≤ The specified value	
焊接耐热性 Resistance to soldering heat	按回流焊试验后, 应满足以下要求 Measurement for solder temperature profile shall be made at the capacitor top and the terminal.		
	Capacitance change	≤ ±10% of the initial value	
	D.F.(tanδ)	≤ 130% of the specified value	
	ESR	≤ 130% of the specified value	
	Leakage current	≤ The specified value	

外形图 Dimensions (mm)

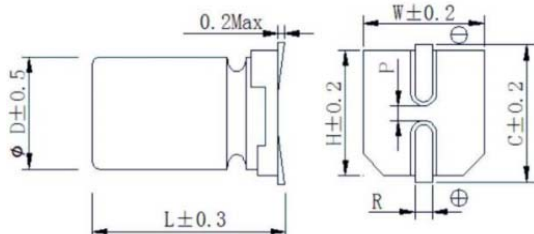

ΦD	W	H	C	R	P
5	5.3	5.3	5.9	0.5~0.8	1.4
6.3	6.5	6.5	7.2	0.5~0.8	2.2
8	8.3	8.3	9.0	0.7~1.1	3.1
10	10.3	10.3	11.0	0.7~1.1	4.5



M1 Series

◆ 纹波电流修正系数 Rated Ripple Current Coefficient

频率 Frequency(Hz)	120Hz \cong f < 1kHz	1kHz \cong f < 10kHz	10kHz \cong f < 100kHz	100kHz \cong f < 500kHz
系数 Coefficient	0.05	0.30	0.70	1.00

◆ 尺寸与个技术参数一览表 Standard Ratings

Rated voltage (V)	Rated capacitance (μ F)	Case size Φ D×L(mm)	ESR($m\Omega$) at 20°C, 100 KHz	Leakage Current (μ A)	Rated ripple current (mA _{rms} /105°C/100kHz)
2.5	470	6.3*9	15	500	4500
	470	8*9.8	15	500	4800
	560	6.3*9	15	500	4500
	560	8*9.8	15	500	4800
	680	8*12.6	12	500	5100
	820	8*12.6	12	500	5100
4	560	8*9.8	15	500	4500
	680	8*12.6	12	544	4700
	820	10*12.6	12	656	5500
	1000	10*12.6	10	800	5500
	1200	10*12.6	10	960	5500
6.3	220	6.3*9	18	500	3900
	270	6.3*9	18	500	4100
	330	6.3*9	18	500	4100
	470	8*9.8	15	592	4500
	560	8*9.8	15	592	4500
	680	8*12.6	12	857	4700
	820	10*12.6	10	1033	5500
	1000	10*12.6	10	1260	5500
	1500	10*12.6	10	1890	5500
10	220	6.3*9	22	500	3500
	270	6.3*9	22	540	3500
	330	8*9.8	18	660	4100
	470	8*9.8	18	940	4230
	560	8*9.8	18	1120	4230
	680	8*12.6	15	1360	4500
	820	10*12.6	12	1640	5300
	1000	10*12.6	12	2000	5300
16	47	6.3*9	25	500	2690
	68	6.3*9	25	500	2690
	82	6.3*9	25	500	2690
	100	6.3*9	25	500	2690
	220	6.3*9	25	704	2690



M1 Series

◆ 尺寸与技术参数一览表 Standard Ratings

Rated voltage (V)	Rated capacitance (uF)	Case size $\Phi D \times L$ (mm)	ESR (m Ω) at 20°C, 100 KHz	Leakage Current (μ A)	Rated ripple current (mA _{rms} /105°C/100kHz)
16	220	8*9.8	20	704	3200
	220	8*12.6	16	704	4100
	270	8*9.8	20	864	3200
	330	6.3*9	22	1056	2690
	330	8*9.8	20	1056	3200
	330	8*12.6	16	1056	4100
	470	8*12.6	16	1504	4100
	470	10*12.6	14	1504	5100
	560	8*12.6	16	1792	4100
	680	10*12.6	14	2176	5100
	820	10*12.6	14	2624	5100
	1000	10*12.6	14	3200	5100
	25	22	6.3*9	30	500
33		6.3*9	30	500	2100
47		6.3*9	30	500	2100
47		8*9.8	25	500	2690
68		6.3*9	30	500	2100
82		6.3*9	30	500	2100
100		6.3*9	30	500	2100
100		8*9.8	25	500	2690
150		8*9.8	25	750	2690
220		8*12.6	25	1100	2900
220		10*12.6	20	1100	3500
270		8*12.6	25	1350	2900
330		10*12.6	20	1650	3500
470		10*12.6	20	2350	3500
35		10	6.3*9	90	299
	22	6.3*9	90	299	1410
	33	6.3*9	90	299	1410
	47	6.3*9	60	299	1410
	82	8*9.8	35	299	1900
	100	8*9.8	30	350	1900
	100	8*12.6	25	350	2690
	220	10*12.6	20	770	3100



M1 Series

◆ 尺寸与个技术参数一览表 Standard Ratings

Rated voltage (V)	Rated capacitance (uF)	Case size $\Phi D \times L$ (mm)	ESR (m Ω) at 20°C, 100 KHz	Leakage Current (μ A)	Rated ripple current (mA _{rms} /105°C/100kHz)
50	10	6.3*9	90	299	800
	22	6.3*9	90	299	850
	33	8*9.8	30	299	1300
	47	8*12.6	25	299	1500
	68	8*12.6	25	340	1500
	100	8*12.6	25	500	1500
	120	10*12.6	20	600	2100
	220	10*12.6	20	1100	2100
63	10	6.3*9	90	299	750
	22	8*9.8	35	299	1100
	33	8*9.8	35	299	1100
	33	8*12.6	30	299	1300
	47	8*12.6	30	299	1300
	68	8*12.6	30	428	1300
	82	10*12.6	25	517	1800
	100	10*12.6	25	630	1800
80	10	6.3*9	100	299	550
	22	8*9.8	50	299	1100
	22	8*12.6	40	299	1300
	33	8*12.6	40	299	1300
	47	10*12.6	35	376	1800
100	10	8*9.8	55	299	850
	15	8*12.6	45	299	1190
	22	10*12.6	40	299	1550
	33	10*12.6	40	330	1550



M2 Series

- Low ESR, High ripple, miniaturized
- SMD type: lead free reflow soldering condition at 260°C peak correspondence
- RoHS Compliant

规格表 Specifications

项目 Items	特性参数 Characteristics		
使用温度范围 Category Temperature Range	-55 ~ +105°C		
额定工作电压范围 Rated Voltage Range	2.5 ~ 100V		
静电容量允许偏差 Capacitance tolerance	±20%(M) (at 20°C, 120Hz)		
漏电流 Leakage Current	施加额定工作电压2分钟后读数, 小于或等于规格值 (at 20°C) Less than or equal to the specified value. After 2 minutes application of rated Voltage at 20°C		
	2.5~25V	35~100V	
损耗角正切值tanδ Dissipation Factor	Rated voltage (V)	2.5~6.3	10~100
	tanδ (Max.)	0.08	0.12
温度特性 Low Temperature Characteristics (Max.Impedance Ratio)	Z(-25°C)/Z(+20°C)	≦ 1.25	(100KHz)
	Z(-55°C)/Z(+20°C)	≦ 1.25	
耐久性 Endurance	105°C施加额定工作电压2000小时, 恢复到20°C后, 产品性能应满足以下要求 The specifications listed below shall be satisfied when the capacitors are restored to 20°C after application of rated voltage for 2000 hours at 105°C.		
	Appearance	No significant damage	
	Capacitance change	≦ ±20% of the initial value	
	D.F.(tanδ)	≦ 150% of the specified value	
	ESR	≦ 150% of the specified value	
	Leakage current	≦ The specified value	
耐湿负荷特性 Damp Heat (Steady State)	在60°C 温度, 湿度90%~95%RH的环境中, 施加额定电压1000小时后, 恢复到20°C后, 产品性能应满足以下要求 The specifications listed below shall be satisfied when the capacitors are restored to 20°C after application of rated voltage for 1000 hours at 60°C, 90%~ 95% RH.		
	Appearance	No significant damage	
	Capacitance change	≦ ±20% of the initial value	
	D.F.(tanδ)	≦ 150% of the specified value	
	ESR	≦ 150% of the specified value	
	Leakage current	≦ The specified value	
浪涌电压特性 (Surge Voltage)	浪涌电压=额定电压× 1.15(V) Surge Voltage=Rated voltage × 1.15(V) 在105°C环境中, 按充电30秒; 放电5分30秒, 连续施加浪涌电压1000次(Rc=1kΩ), 待恢复测试, 应满足以下要求 The capacitors shall be subjected to 1000 cycles each consisting of charge with the surge voltages specified at 105°C for 30 seconds through a protective resistor (Rc=1kΩ) and discharge for 5 minutes 30 seconds.		
	Appearance	No significant damage	
	Capacitance change	≦ ±20% of the initial value	
	D.F.(tanδ)	≦ 150% of the specified value	
	ESR	≦ 150% of the specified value	
	Leakage current	≦ The specified value	
焊接耐热性 Resistance to soldering heat	按回流焊试验后, 应满足以下要求 Measurement for solder temperature profile shall be made at the capacitor top and the terminal.		
	Capacitance change	≦ ±10% of the initial value	
	D.F.(tanδ)	≦ 130% of the specified value	
	ESR	≦ 130% of the specified value	
	Leakage current	≦ The specified value	

外形图 Dimensions (mm)

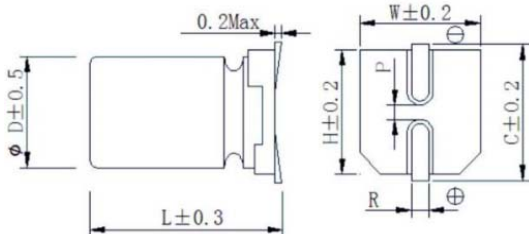

ΦD	W	H	C	R	P
5	5.3	5.3	5.9	0.5~0.8	1.4
6.3	6.5	6.5	7.2	0.5~0.8	2.2
8	8.3	8.3	9.0	0.7~1.1	3.1
10	10.3	10.3	11.0	0.7~1.1	4.5



M2 Series

◆ 纹波电流修正系数 Rated Ripple Current Coefficient

频率Frequency(Hz)	120Hz \cong f < 1kHz	1kHz \cong f < 10kHz	10kHz \cong f < 100kHz	100kHz \cong f < 500kHz
系数 Coefficient	0.05	0.30	0.70	1.00

◆ 尺寸与个技术参数一览表Standard Ratings

Rated voltage (V)	Rated capacitance (μ F)	Case size Φ D×L(mm)	ESR($m\Omega$) at 20°C, 100 KHz	Leakage Current (μ A)	Rated ripple current (mA _{rms} /105°C/100kHz)
2.5	470	6.3*9	30	500	4100
	470	8*9.8	30	500	4500
	560	6.3*9	30	500	4100
	560	8*9.8	30	500	4500
	680	8*12.6	25	500	4800
	820	8*12.6	25	500	4800
4	560	8*9.8	30	500	4250
	680	8*12.6	25	544	4700
	820	10*12.6	20	656	5100
	1000	10*12.6	20	800	5100
	1200	10*12.6	20	960	5100
6.3	220	6.3*9	35	500	3500
	270	6.3*9	35	500	3500
	330	6.3*9	35	500	3500
	470	8*9.8	35	592	3800
	560	8*9.8	35	706	3800
	680	8*12.6	25	857	4300
	820	10*12.6	25	1033	4800
	1000	10*12.6	25	1260	4800
	1500	10*12.6	25	1890	4800
10	220	6.3*9	35	500	2900
	270	6.3*9	35	540	2900
	330	8*9.8	35	660	3600
	470	8*9.8	35	940	3600
	560	8*9.8	35	1120	3600
	680	8*12.6	25	1360	4200
	820	10*12.6	25	1640	4500
	1000	10*12.6	25	2000	4500
16	47	6.3*9	50	500	2690
	68	6.3*9	40	500	2690
	82	6.3*9	40	500	2690
	100	6.3*9	40	500	2690
	220	6.3*9	40	704	2690



M2 Series

◆ 尺寸与个技术参数一览表 Standard Ratings

Rated voltage (V)	Rated capacitance (uF)	Case size $\Phi D \times L$ (mm)	ESR (m Ω) at 20°C, 100 KHz	Leakage Current (μA)	Rated ripple current (mA _{rms} /105°C/100kHz)
16	220	8*9.8	40	704	2900
	220	8*12.6	30	704	3500
	270	8*9.8	40	864	2900
	330	6.3*9	40	1056	2690
	330	8*9.8	40	1056	2900
	330	8*12.6	30	1056	3500
	470	8*12.6	30	1504	3500
	470	10*12.6	30	1504	4100
	560	8*12.6	30	1792	3500
	680	10*12.6	30	2176	4100
	820	10*12.6	30	2624	4100
	1000	10*12.6	30	3200	4100
	25	22	6.3*9	60	500
33		6.3*9	60	500	2100
47		6.3*9	60	500	2100
47		8*9.8	50	500	2690
68		6.3*9	50	500	2100
82		6.3*9	50	500	2100
100		6.3*9	50	500	2100
100		8*9.8	50	500	2690
150		8*9.8	50	750	2690
220		8*12.6	50	1100	2900
220		10*12.6	45	1100	3500
270		8*12.6	50	1350	2900
330		10*12.6	45	1650	3500
470		10*12.6	45	2350	3500
35		10	6.3*9	100	299
	22	6.3*9	100	299	1410
	33	6.3*9	100	299	1410
	47	6.3*9	80	299	1410
	82	8*9.8	55	299	1900
	100	8*9.8	55	350	1900
	100	8*12.6	55	350	2690
	220	10*12.6	50	770	3100



M2 Series

◆ 尺寸与个技术参数一览表 Standard Ratings

Rated voltage (V)	Rated capacitance (uF)	Case size $\Phi D \times L$ (mm)	ESR (m Ω) at 20°C, 100 KHz	Leakage Current (μA)	Rated ripple current (mA _{rms} /105°C/100kHz)
50	10	6.3*9	100	299	800
	22	6.3*9	100	299	850
	33	8*9.8	60	299	1300
	47	8*12.6	60	299	1500
	68	8*12.6	60	340	1500
	100	8*12.6	60	500	1500
	120	10*12.6	55	600	2100
	220	10*12.6	55	1100	2100
63	10	6.3*9	110	299	750
	22	8*9.8	60	299	1100
	33	8*9.8	60	299	1100
	33	8*12.6	60	299	1300
	47	8*12.6	60	299	1300
	68	8*12.6	60	428	1300
	82	10*12.6	55	517	1800
	100	10*12.6	55	630	1800
80	10	6.3*9	120	299	550
	22	8*9.8	80	299	1100
	22	8*12.6	70	299	1300
	33	8*12.6	70	299	1300
	47	10*12.6	60	376	1800
100	10	8*9.8	90	299	850
	15	8*12.6	70	299	1190
	22	10*12.6	60	299	1550
	33	10*12.6	60	330	1550



M5 Series

- Low ESR, High ripple, miniaturized
- SMD type: lead free reflow soldering condition at 260°C peak correspondence
- RoHS Compliant

规格表 Specifications

项目 Items	特性参数 Characteristics		
使用温度范围 Category Temperature Range	-55 ~ +105°C		
额定工作电压范围 Rated Voltage Range	10 ~ 50V		
静电容量允许偏差 Capacitance tolerance	±20%(M) (at 20°C, 120Hz)		
漏电流 Leakage Current	施加额定工作电压2分钟后读数, 小于或等于规格值 (at 20°C) Less than or equal to the specified value. After 2 minutes application of rated Voltage at 20°C		2.5~25V 35~100V
			I≤0.2CV 或500μA(取大值) I≤0.1CV 或299μA(取大值)
损耗角正切值tanδ Dissipation Factor	Rated voltage (V)	2.5~6.3	10~100
	tanδ (Max.)	0.08	0.12
温度特性 Low Temperature Characteristics (Max.Impedance Ratio)	Z(-25°C)/Z(+20°C)	≤ 1.25	(100KHz)
	Z(-55°C)/Z(+20°C)	≤ 1.25	
耐久性 Endurance	105°C施加额定工作电压5000小时, 恢复到20°C后, 产品性能应满足以下要求 The specifications listed below shall be satisfied when the capacitors are restored to 20°C after application of rated voltage for 5000 hours at 105°C.		
	Appearance	No significant damage	
	Capacitance change	≤ ±20% of the initial value	
	D.F.(tanδ)	≤ 150% of the specified value	
	ESR	≤ 150% of the specified value	
	Leakage current	≤ The specified value	
耐湿负荷特性 Damp Heat (Steady State)	在60°C 温度, 湿度90%~95%RH的环境中, 施加额定电压1000小时后, 恢复到20°C后, 产品性能应满足以下要求 The specifications listed below shall be satisfied when the capacitors are restored to 20°C after application of rated voltage for 1000 hours at 60°C, 90%~ 95% RH.		
	Appearance	No significant damage	
	Capacitance change	≤ ±20% of the initial value	
	D.F.(tanδ)	≤ 150% of the specified value	
	ESR	≤ 150% of the specified value	
	Leakage current	≤ The specified value	
浪涌电压特性 (Surge Voltage)	浪涌电压=额定电压× 1.15(V) Surge Voltage=Rated voltage × 1.15(V) 在105°C环境中, 按充电30秒; 放电5分30秒, 连续施加浪涌电压1000次(Rc=1kΩ), 待恢复测试, 应满足以下要求 The capacitors shall be subjected to 1000 cycles each consisting of charge with the surge voltages specified at 105°C for 30 seconds through a protective resistor (Rc=1kΩ) and discharge for 5 minutes 30 seconds.		
	Appearance	No significant damage	
	Capacitance change	≤ ±20% of the initial value	
	D.F.(tanδ)	≤ 150% of the specified value	
	ESR	≤ 150% of the specified value	
	Leakage current	≤ The specified value	
焊接耐热性 Resistance to soldering heat	按回流焊试验后, 应满足以下要求 Measurement for solder temperature profile shall be made at the capacitor top and the terminal.		
	Capacitance change	≤ ±10% of the initial value	
	D.F.(tanδ)	≤ 130% of the specified value	
	ESR	≤ 130% of the specified value	
	Leakage current	≤ The specified value	

外形图 Dimensions (mm)

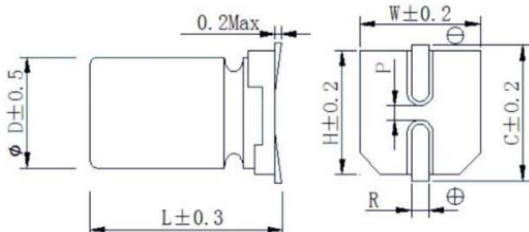

ΦD	W	H	C	R	P
5	5.3	5.3	5.9	0.5~0.8	1.4
6.3	6.5	6.5	7.2	0.5~0.8	2.2
8	8.3	8.3	9.0	0.7~1.1	3.1
10	10.3	10.3	11.0	0.7~1.1	4.5



M5 Series

◆ 纹波电流修正系数 Rated Ripple Current Coefficient

频率 Frequency(Hz)	120Hz \cong f < 1kHz	1kHz \cong f < 10kHz	10kHz \cong f < 100kHz	100kHz \cong f < 500kHz
系数 Coefficient	0.05	0.30	0.70	1.00

◆ 尺寸与个技术参数一览表 Standard Ratings

Rated voltage (V)	Rated capacitance (μ F)	Case size Φ D×L(mm)	ESR($m\Omega$) at 20°C, 100 KHz	Leakage Current (μ A)	Rated ripple current (mA _{rms} /105°C/100kHz)
2.5	470	6.3*9	30	500	4100
	470	8*9.8	30	500	4500
	560	6.3*9	30	500	4100
	560	8*9.8	30	500	4500
	680	8*12.6	25	500	4800
	820	8*12.6	25	500	4800
4	560	8*9.8	30	500	4250
	680	8*12.6	25	544	4700
	820	10*12.6	20	656	5100
	1000	10*12.6	20	800	5100
	1200	10*12.6	20	960	5100
6.3	220	6.3*9	35	500	3500
	270	6.3*9	35	500	3500
	330	6.3*9	35	500	3500
	470	8*9.8	35	592	3800
	560	8*9.8	35	706	3800
	680	8*12.6	25	857	4300
	820	10*12.6	25	1033	4800
	1000	10*12.6	25	1260	4800
	1500	10*12.6	25	1890	4800
10	220	6.3*9	35	500	2900
	270	6.3*9	35	540	2900
	330	8*9.8	35	660	3600
	470	8*9.8	35	940	3600
	560	8*9.8	35	1120	3600
	680	8*12.6	25	1360	4200
	820	10*12.6	25	1640	4500
	1000	10*12.6	25	2000	4500
16	47	6.3*9	50	500	2690
	68	6.3*9	40	500	2690
	82	6.3*9	40	500	2690
	100	6.3*9	40	500	2690
	220	6.3*9	40	704	2690



M5 Series

◆ 尺寸与个技术参数一览表 Standard Ratings

Rated voltage (V)	Rated capacitance (uF)	Case size $\Phi D \times L$ (mm)	ESR(m Ω) at 20°C, 100 KHz	Leakage Current (μ A)	Rated ripple current (mA _{rms} /105°C/100kHz)
16	220	8*9.8	40	704	2900
	220	8*12.6	30	704	3500
	270	8*9.8	40	864	2900
	330	6.3*9	40	1056	2690
	330	8*9.8	40	1056	2900
	330	8*12.6	30	1056	3500
	470	8*12.6	30	1504	3500
	470	10*12.6	30	1504	4100
	560	8*12.6	30	1792	3500
	680	10*12.6	30	2176	4100
	820	10*12.6	30	2624	4100
	1000	10*12.6	30	3200	4100
	25	22	6.3*9	60	500
33		6.3*9	60	500	2100
47		6.3*9	60	500	2100
47		8*9.8	50	500	2690
68		6.3*9	50	500	2100
82		6.3*9	50	500	2100
100		6.3*9	50	500	2100
100		8*9.8	50	500	2690
150		8*9.8	50	750	2690
220		8*12.6	50	1100	2900
220		10*12.6	45	1100	3500
270		8*12.6	50	1350	2900
330		10*12.6	45	1650	3500
470		10*12.6	45	2350	3500
35		10	6.3*9	100	299
	22	6.3*9	100	299	1410
	33	6.3*9	100	299	1410
	47	6.3*9	80	299	1410
	82	8*9.8	55	299	1900
	100	8*9.8	55	350	1900
	100	8*12.6	55	350	2690
	220	10*12.6	50	770	3100



M5 Series

◆ 尺寸与个技术参数一览表 Standard Ratings

Rated voltage (V)	Rated capacitance (uF)	Case size $\Phi D \times L$ (mm)	ESR (m Ω) at 20°C, 100 KHz	Leakage Current (μA)	Rated ripple current (mA _{rms} /105°C/100kHz)
50	10	6.3*9	100	299	800
	22	6.3*9	100	299	850
	33	8*9.8	60	299	1300
	47	8*12.6	60	299	1500
	68	8*12.6	60	340	1500
	100	8*12.6	60	500	1500
	120	10*12.6	55	600	2100
	220	10*12.6	55	1100	2100
63	10	6.3*9	110	299	750
	22	8*9.8	60	299	1100
	33	8*9.8	60	299	1100
	33	8*12.6	60	299	1300
	47	8*12.6	60	299	1300
	68	8*12.6	60	428	1300
	82	10*12.6	55	517	1800
	100	10*12.6	55	630	1800
80	10	6.3*9	120	299	550
	22	8*9.8	80	299	1100
	22	8*12.6	70	299	1300
	33	8*12.6	70	299	1300
	47	10*12.6	60	376	1800
100	10	8*9.8	90	299	850
	15	8*12.6	70	299	1190
	22	10*12.6	60	299	1550
	33	10*12.6	60	330	1550



H6 Series

- Low ESR, high ripple current, high voltage
- Load life of 2000 hours at 105°C
- RoHS Compliant

◆ 规格表 Specifications

项目 Items	特性参数 Characteristics		
使用温度范围 Category Temperature Range	-55 ~ +105°C		
额定工作电压范围 Rated Voltage Range	10 ~ 50V		
静电容量允许偏差 Capacitance tolerance	±20%(M) (at 20°C, 120Hz)		
漏电流 Leakage Current	施加额定工作电压2分钟后读数, 小于或等于规格值 (at 20°C) I ≤ 0.03CV 或 18μA (取大值) Less than or equal to the specified value. After 2 minutes application of rated Voltage at 20°C		
损耗角正切值 tanδ Dissipation Factor	Rated voltage (V)	10~50	(at 20°C, 120Hz)
	tanδ (Max.)	0.16	
温度特性 Low Temperature Characteristics (Max.Impedance Ratio)	Z(-25°C)/Z(+20°C)	≅ 0.75 to 2.0	(100KHz)
	Z(-55°C)/Z(+20°C)	≅ 0.75 to 1.5	
耐久性 Endurance	105°C 施加额定工作电压2000小时, 恢复到20°C后, 产品性能应满足以下要求 The specifications listed below shall be satisfied when the capacitors are restored to 20°C after application of rated voltage for 2000 hours at 105°C.		
	Appearance	No significant damage	
	Capacitance change	≅ ±30% of the initial value	
	D.F.(tanδ)	≅ 200% of the specified value	
	ESR	≅ 200% of the specified value	
	Leakage current	≅ The specified value	
耐湿负荷特性 Damp Heat (Steady State)	在60°C 温度, 湿度90%~95%RH的环境中, 施加额定电压1000小时后, 恢复到20°C后, 产品性能应满足以下要求 The specifications listed below shall be satisfied when the capacitors are restored to 20°C after application of rated voltage for 1000 hours at 60°C, 90%~95% RH.		
	Appearance	No significant damage	
	Capacitance change	≅ ±30% of the initial value	
	D.F.(tanδ)	≅ 200% of the specified value	
	ESR	≅ 200% of the specified value	
	Leakage current	≅ The specified value	
浪涌电压特性 (Surge Voltage)	浪涌电压=额定电压× 1.25(V) Surge Voltage=Rated voltage × 1.25(V) 在105°C环境中, 按充电30秒; 放电5分30秒, 连续施加浪涌电压1000次(Rc=1kΩ), 待恢复后测试, 应满足以下要求 The capacitors shall be subjected to 1000 cycles each consisting of charge with the surge voltages specified at 105°C for 30 seconds through a protective resistor (Rc=1kΩ) and discharge for 5 minutes 30 seconds		
	Appearance	No significant damage	
	Capacitance change	≅ ±30% of the initial value	
	D.F.(tanδ)	≅ 200% of the specified value	
	ESR	≅ 200% of the specified value	
	Leakage current	≅ The specified value	

◆ 外形图 Dimensions (mm)

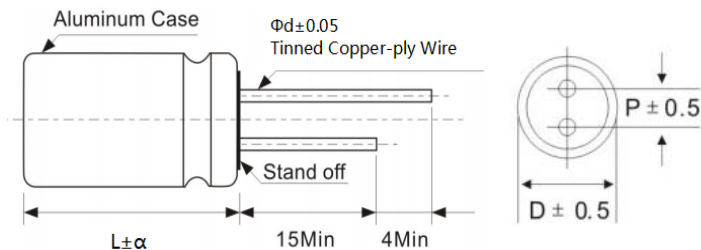

ΦD	5	6.3	8	10
P	2.0	2.5	3.5	5.0
Φd	0.5	0.6	0.6	0.6

α	L+1.5Max
---	----------



H6 Series

◆ 纹波电流修正系数 Rated Ripple Current Coefficient

频率Frequency(Hz)	120Hz \leq f < 1kHz	1kHz \leq f < 10kHz	10kHz \leq f < 100kHz	100kHz \leq f < 500kHz
系数 Coefficient	0.05	0.30	0.70	1.00

◆ 尺寸与个技术参数一览表 Standard Ratings

Rated voltage (V)	Rated capacitance (μ F)	Case size Φ D×L(mm)	ESR($m\Omega$) at 20°C, 100 KHz	Leakage Current (μ A)	Rated ripple current (mA rms/105°C/100kHz)
10	100	6.3*8	40	30	2000
	220	8*9	25	66	2490
	470	8*12	25	141	2500
	1000	10*12	15	300	3100
16	100	6.3*8	40	48	1500
	270	8*9	25	130	2000
	470	8*12	25	226	2250
	1000	10*12	18	480	2900
25	56	6.3*8	50	42	1400
	100	8*9	30	75	1900
	220	8*12	30	165	2100
	330	10*12	16	248	2900
35	47	6.3*8	60	49	1300
	100	8*9	30	105	1800
	150	8*12	30	158	2100
	220	10*12	20	231	2830
50	15	6.3*8	80	23	1200
	33	8*9	35	50	1670
	100	8*12	35	150	1800
	220	10*12	25	330	2650



M6 Series

- Low ESR, High ripple, miniaturized
- SMD type: lead free reflow soldering condition at 260°C peak correspondence
- RoHS Compliant

规格表 Specifications

项目 Items	特性参数 Characteristics		
使用温度范围 Category Temperature Range	-55 ~ +105°C		
额定工作电压范围 Rated Voltage Range	10 ~ 50V		
静电容量允许偏差 Capacitance tolerance	±20%(M) (at 20°C, 120Hz)		
漏电流 Leakage Current	施加额定工作电压2分钟后读数, 小于或等于规格值 (at 20°C) I ≤ 0.03CV 或 18μA (取大值) Less than or equal to the specified value. After 2 minutes application of rated Voltage at 20°C		
损耗角正切值 tanδ Dissipation Factor	Rated voltage (V)	10~50	(at 20°C, 120Hz)
	tanδ (Max.)	0.16	
温度特性 Low Temperature Characteristics (Max. Impedance Ratio)	Z(-25°C)/Z(+20°C)	≅ 0.75 to 2.0	(100KHz)
	Z(-55°C)/Z(+20°C)	≅ 0.75 to 2.0	
耐久性 Endurance	105°C 施加额定工作电压 2000 小时, 恢复到 20°C 后, 产品性能应满足以下要求 The specifications listed below shall be satisfied when the capacitors are restored to 20°C after application of rated voltage for 2000 hours at 105°C.		
	Appearance	No significant damage	
	Capacitance change	≅ ±30% of the initial value	
	D.F.(tanδ)	≅ 200% of the specified value	
	ESR	≅ 200% of the specified value	
	Leakage current	≅ The specified value	
耐湿负荷特性 Damp Heat (Steady State)	在 60°C 温度, 湿度 90%~95%RH 的环境中, 施加额定电压 1000 小时后, 恢复到 20°C 后, 产品性能应满足以下要求 The specifications listed below shall be satisfied when the capacitors are restored to 20°C after application of rated voltage for 1000 hours at 60°C, 90%~95% RH.		
	Appearance	No significant damage	
	Capacitance change	≅ ±30% of the initial value	
	D.F.(tanδ)	≅ 200% of the specified value	
	ESR	≅ 200% of the specified value	
	Leakage current	≅ The specified value	
浪涌电压特性 (Surge Voltage)	浪涌电压=额定电压×1.25(V) Surge Voltage=Rated voltage × 1.25(V) 在 105°C 环境中, 按充电 30 秒; 放电 5 分 30 秒, 连续施加浪涌电压 1000 次 (Rc=1kΩ), 待恢复测试, 应满足以下要求 The capacitors shall be subjected to 1000 cycles each consisting of charge with the surge voltages specified at 105°C for 30 seconds through a protective resistor (Rc=1kΩ) and discharge for 5 minutes 30 seconds.		
	Appearance	No significant damage	
	Capacitance change	≅ ±30% of the initial value	
	D.F.(tanδ)	≅ 200% of the specified value	
	ESR	≅ 200% of the specified value	
	Leakage current	≅ The specified value	
焊接耐热性 Resistance to soldering heat	按回流焊试验后, 应满足以下要求 Measurement for solder temperature profile shall be made at the capacitor top and the terminal.		
	Capacitance change	≅ ±10% of the initial value	
	D.F.(tanδ)	≅ 130% of the specified value	
	ESR	≅ 130% of the specified value	
	Leakage current	≅ The specified value	

外形图 Dimensions (mm)

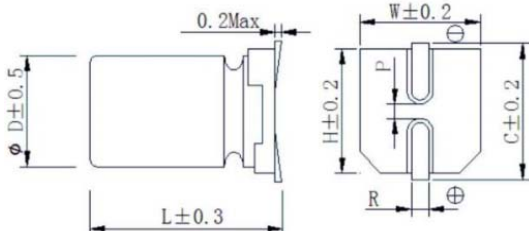

ΦD	W	H	C	R	P
5	5.3	5.3	5.9	0.5~0.8	1.4
6.3	6.5	6.5	7.2	0.5~0.8	2.2
8	8.3	8.3	9.0	0.7~1.1	3.1
10	10.3	10.3	11.0	0.7~1.1	4.5



M6 Series

◆ 纹波电流修正系数 Rated Ripple Current Coefficient

频率Frequency(Hz)	120Hz \leq f < 1kHz	1kHz \leq f < 10kHz	10kHz \leq f < 100kHz	100kHz \leq f < 500kHz
系数 Coefficient	0.05	0.30	0.70	1.00

◆ 尺寸与个技术参数一览表 Standard Ratings

Rated voltage (V)	Rated capacitance (μ F)	Case size Φ D×L(mm)	ESR($m\Omega$) at 20°C, 100 KHz	Leakage Current (μ A)	Rated ripple current (mA _{rms} /105°C/100kHz)
10	100	6.3*9	40	30	2000
	220	8*9.8	25	66	2490
	470	8*12.6	25	141	2500
	1000	10*12.6	15	300	3100
16	100	6.3*9	40	48	1500
	270	8*9.8	25	130	2000
	470	8*12.6	25	226	2250
	1000	10*12.6	18	480	2900
25	56	6.3*9	50	42	1400
	100	8*9.8	30	75	1900
	220	8*12.6	30	165	2100
	330	10*12.6	16	248	2900
35	47	6.3*9	60	49	1300
	100	8*9.8	30	105	1800
	150	8*12.6	30	158	2100
	220	10*12.6	20	231	2830
50	15	6.3*9	80	23	1200
	33	8*9.8	35	50	1670
	100	8*12.6	35	150	1800
	220	10*12.6	25	330	2650

X-ON Electronics

Largest Supplier of Electrical and Electronic Components

Click to view similar products for [Aluminum Organic Polymer Capacitors](#) category:

Click to view products by [Ruilong](#) manufacturer:

Other Similar products are found below :

[D38999/20WJ43SN-LC](#) [750-1809](#) [MS27467T25F24P](#) [MS27467T25F24S](#) [MS27467T25F29P](#) [176P12](#) [SEAU0A0102G](#) [BTM-16-513](#)
[MS3470W8-33P L/C](#) [MAL218497702E3](#) [MAL218497801E3](#) [MAL218397005E3](#) [MAL218297003E3](#) [MAL218397603E3](#) [MAL218297802E3](#)
[MAL218497701E3](#) [MAL218697502E3](#) [MAL218397102E3](#) [MAL218297804E3](#) [MAL218497902E3](#) [MAL218497804E3](#) [MAL218297001E3](#)
[MAL218697005E3](#) [MAL218697509E3](#) [MAL218397806E3](#) [MAL218297603E3](#) [MAL218397604E3](#) [MAL218697106E3](#) [MAL218297005E3](#)
[MAL218397106E3](#) [MAL218297103E3](#) [MAL218697108E3](#) [MAL218497903E3](#) [MAL218497703E3](#) [MAL218297701E3](#) [MAL218297101E3](#)
[MAL218397104E3](#) [MAL218397801E3](#) [MAL218297604E3](#) [MAL218397803E3](#) [MAL218697601E3](#) [MAL218697554E3](#) [MAL218697607E3](#)
[MAL218397805E3](#) [MAL218297105E3](#) [MAL218397702E3](#) [MAL218697104E3](#) [MAL218297702E3](#) [MAL218497901E3](#) [MAL218497806E3](#)