

Transient Voltage Suppressors

1.5KE Series

Transient Voltage Suppressors - 1.5KE Series

Features

1. Halogen-free
2. Rohs compliant
3. Typical maximum temperature coefficient
4. $\Delta V_{BR} = 0.1\% \times V_{BR} @ 25^\circ\text{C} \times \Delta T$
5. Glass passivated Chip junction in DO-201 package
6. 1500W peak pulse capadility at 10x1000 μs waveform, repetition rate (duty cycles):0.01%
7. Fast response time: typically less than 1.0ps from 0 Volts to BV min
8. Excellent clamping capability
9. Low incremental surge resistance
10. Typical IR less than 5 μA above 11V
11. High temperature soldering guaranteed: 260 $^\circ\text{C}$ /40 seconds / 0.375", (9.5mm) lead length, 5lbs., (2.3kg)tension
12. Plastic package has underwriters laboratory flammability classification 94v-0
13. Matte Tin Lead-free plated

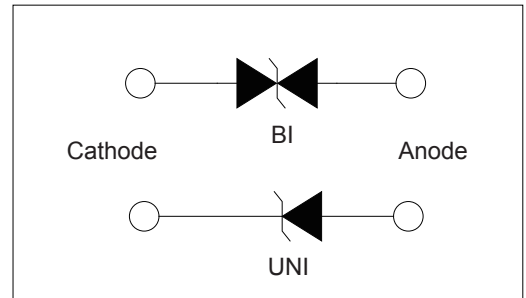
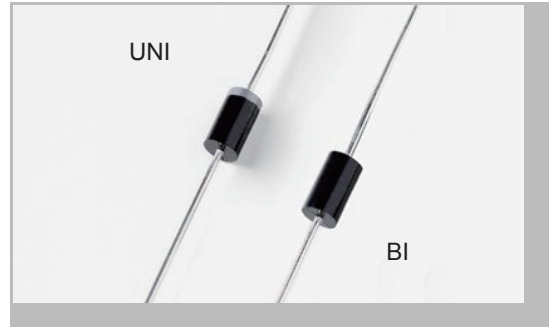

Applications

TVS devices are ideal for the protection of I/O interfaces, VCC bus and other vulnerable circuits used in telecom, computer, industrial and consumer electronic applications.

Mechanical Characteristics

Rating	Symbol	Value	Units
Peak Pulse Power Dissipation by 10x1000 μs test waveform (Fig.1)(Note 1)	P_{PPM}	1500	Watts
Steady State Power Dissipation on infinite heat sink at TL=75 $^\circ\text{C}$ (Fig. 5)	P_D	6.5	Watts
Peak Forward Surge Current, 8.3ms Single Half Sine Wave Unidirectional only (Note 2)	I_{FSM}	200	Amps
Maximum Instantaneous Forward Voltage at 25A for Unidirectional only (Note 3)	V_F	3.5/5.0	V
Operating junction and Storage Temperature Range.	T_J, T_{STG}	-55 $^\circ\text{C}$ to 175 $^\circ\text{C}$	$^\circ\text{C}$
Typical Thermal Resistance Junction to Lead	$R_{\theta JL}$	15	$^\circ\text{C}/\text{W}$
Typical Thermal Resistance Junction to Ambient	$R_{\theta JA}$	75	$^\circ\text{C}/\text{W}$
Reverse current	I_F	100	A

Notes:

1. Non-repetitive current pulse , per Fig. 3 and derated above $T_A = 25^\circ\text{C}$ per Fig. 2.
2. Measured on 8.3ms single half sine wave or equivalent square wave, duty cycle=4 perminute maximum.
3. $V_F < 3.5\text{V}$ for devices of $V_{BR} < 200\text{V}$ and $V_F < 5.0\text{V}$ for devices of $V_{BR} > 201\text{V}$.

Transient Voltage Suppressors - 1.5KE Series

Electrical Characteristics

Type Number		Reverse Stand-Off Voltage VRWM(V)	Breakdown Voltage Min.@IT		Test Current IT(mA)	Maximum Clamping Voltage@IPP VC(V)	Peak Pulse Current IPP(A)	Reverse Leakage @VRWM IR(μA)
(UNI)	(BI)		VBR MIN.(V)	VBR.MAX.(V)				
1.5KE6.8A	1.5KE6.8CA	5.80	6.45	7.14	10	10.5	144.8	1000
1.5KE7.5A	1.5KE7.5CA	6.40	7.13	7.88	10	11.3	134.5	500
1.5KE8.2A	1.5KE8.2CA	7.02	7.79	8.61	10	12.1	125.6	200
1.5KE9.1A	1.5KE9.1CA	7.78	8.65	9.50	1	13.4	113.4	50
1.5KE10A	1.5KE10CA	8.55	9.50	10.50	1	14.5	104.8	10
1.5KE11A	1.5KE11CA	9.40	10.50	11.60	1	15.6	97.4	5
1.5KE12A	1.5KE12CA	10.20	11.40	12.60	1	16.7	91.0	5
1.5KE13A	1.5KE13CA	11.10	12.40	13.70	1	18.2	83.5	5
1.5KE15A	1.5KE15CA	12.80	14.30	15.80	1	21.2	71.7	5
1.5KE16A	1.5KE16CA	13.60	15.20	16.80	1	22.5	67.6	5
1.5KE18A	1.5KE18CA	15.30	17.10	18.90	1	25.2	60.3	5
1.5KE20A	1.5KE20CA	17.10	19.00	21.00	1	27.7	54.9	5
1.5KE22A	1.5KE22CA	18.80	20.90	23.10	1	30.6	49.7	5
1.5KE24A	1.5KE24CA	20.50	22.80	25.20	1	33.2	45.8	5
1.5KE27A	1.5KE27CA	23.10	25.70	28.40	1	37.5	40.5	5
1.5KE30A	1.5KE30CA	25.60	28.50	31.50	1	41.4	36.7	5
1.5KE33A	1.5KE33CA	28.20	31.40	34.70	1	45.7	33.3	5
1.5KE36A	1.5KE36CA	30.80	34.20	37.80	1	49.9	30.5	5
1.5KE39A	1.5KE39CA	33.30	37.10	41.00	1	53.9	28.2	5
1.5KE43A	1.5KE43CA	36.80	40.90	45.20	1	59.3	25.6	5
1.5KE47A	1.5KE47CA	40.20	44.70	49.40	1	64.8	23.5	5
1.5KE51A	1.5KE51CA	43.60	48.50	53.60	1	70.1	21.7	5
1.5KE56A	1.5KE56CA	47.80	53.20	58.80	1	77.0	19.7	5
1.5KE62A	1.5KE62CA	53.00	58.90	65.10	1	85.0	17.9	5
1.5KE68A	1.5KE68CA	58.10	64.60	71.40	1	92.0	16.5	5
1.5KE75A	1.5KE75CA	64.10	71.30	78.80	1	103.0	14.8	5
1.5KE82A	1.5KE82CA	70.10	77.90	86.10	1	113.0	13.5	5
1.5KE91A	1.5KE91CA	77.80	86.50	95.50	1	125.0	12.2	5
1.5KE100A	1.5KE100CA	85.50	95.00	105.00	1	137.0	11.1	5
1.5KE110A	1.5KE110CA	94.00	105.00	116.00	1	152.0	10.0	5
1.5KE120A	1.5KE120CA	102.00	114.00	126.00	1	165.0	9.20	5
1.5KE130A	1.5KE130CA	111.00	124.00	137.00	1	179.0	8.50	5
1.5KE150A	1.5KE150CA	128.00	143.00	158.00	1	207.0	7.30	5
1.5KE160A	1.5KE160CA	136.00	152.00	168.00	1	219.0	6.60	5
1.5KE170A	1.5KE170CA	145.00	162.00	179.00	1	234.0	6.50	5
1.5KE180A	1.5KE180CA	154.00	171.00	189.00	1	246.0	6.20	5
1.5KE200A	1.5KE200CA	171.00	190.00	210.00	1	274.0	5.50	5
1.5KE220A	1.5KE220CA	185.00	209.00	231.00	1	328.0	4.60	5
1.5KE250A	1.5KE250CA	214.00	237.00	263.00	1	344.0	4.40	5
1.5KE300A	1.5KE300CA	256.00	285.00	315.00	1	414.0	3.70	5
1.5KE350A	1.5KE350CA	300.00	332.00	368.00	1	482.0	3.20	5
1.5KE400A	1.5KE400CA	342.00	380.00	420.00	1	548.0	2.80	5
1.5KE440A	1.5KE440CA	376.00	418.00	462.00	1	602.0	2.50	5
1.5KE480A	1.5KE480CA	408.00	456.00	504.00	1	658.0	2.30	5

For bidirectional type having VR of 10 volts and less, the IR limit is double.

For parts without A, the VBR is +10% and VC is 5% higher than with A parts.

Transient Voltage Suppressors - 1.5KE Series

Ratings and Characteristic Curves

Figure 1 - Peak Pulse Power Rating Curve

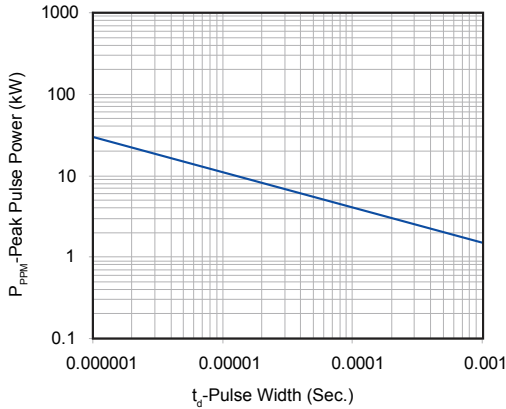

Figure 2 - Pulse Derating Curve

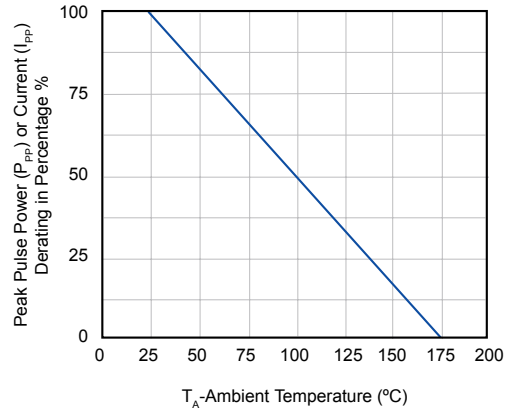

Figure 3 - Pulse Waveform

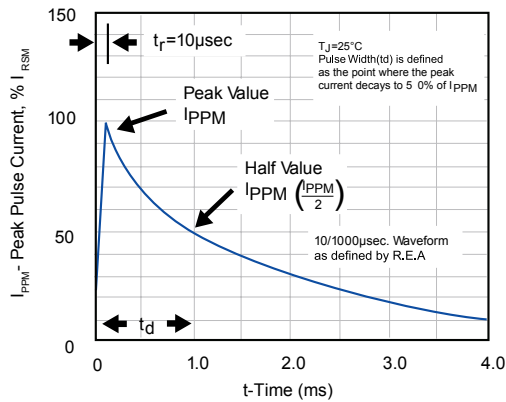

Figure 4 - Typical Junction Capacitance

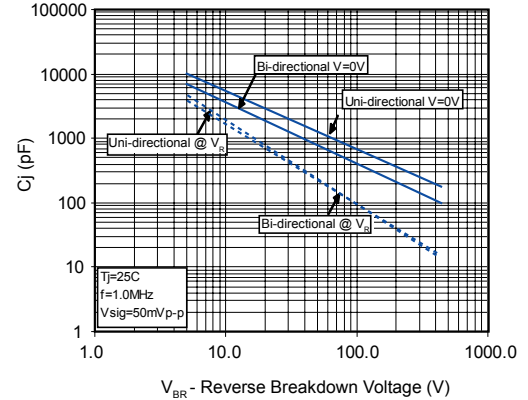

Figure 5 - Steady State Power Derating Curve

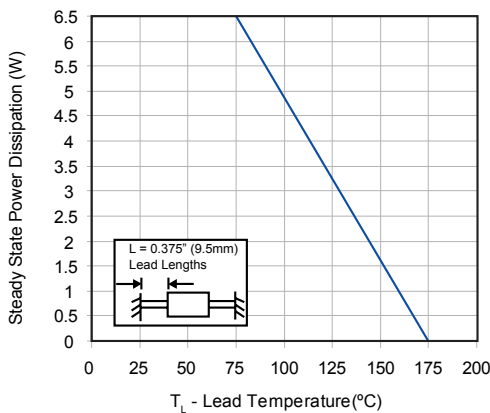
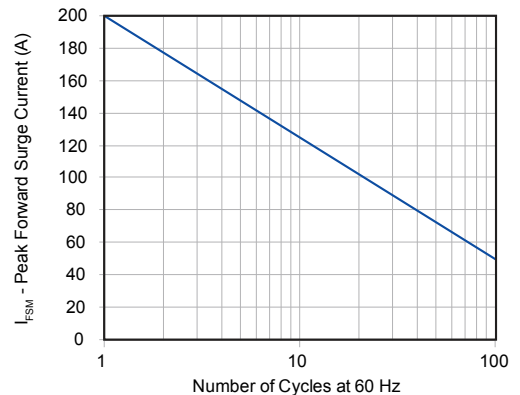

Figure 6 - Maximum Non-Repetitive Peak Forward Surge Current Uni-Directional Only



Transient Voltage Suppressors - 1.5KE Series

Soldering Parameters

	Reflow Condition	Lead-free assembly
Pre Heat	- Temperature Min ($T_{s(min)}$)	150°C
	- Temperature Max ($T_{s(max)}$)	200°C
	- Time (min to max) (t_s)	60-180 secs
Average ramp up rate (Liquidus Temp (T_L) to peak)		3°C/second max
$T_{s(max)}$ to T_L - Ramp-up Rate		3°C/second max
Reflow	- Temperature (T_L) (Liquidus)	217°C
	- Time (min to max) (t_s)	60-150 seconds
Peak Temperature (T_p)		260 ^{+0/-5} °C
Time within 5°C of actual peak Temperature (t_p)		20-40 seconds
Ramp-down Rate		6°C/second max
Time 25°C to peak Temperature (T_p)		8 minutes Max.
Do not exceed		280°C

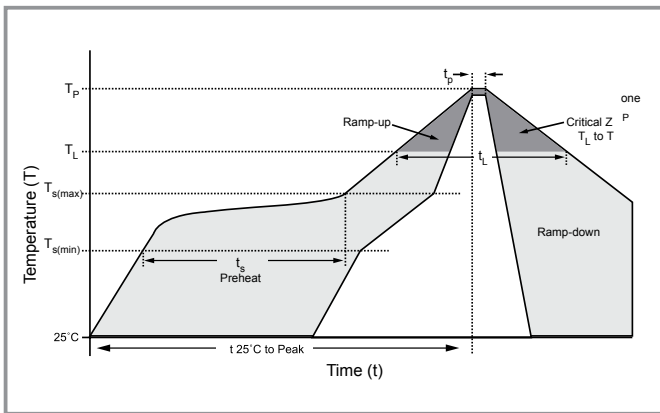

Physical Specifications

Weight	0.045oz., 1.2g
Case	JEDEC DO-201 molded plastic body over passivated junction.
Polarity	Color band denotes the cathode except Bipolar.
Termina	Matte Tin axial leads, solderable per JESD22-B102D.

Environmental Specifications

Temperature Cycle	JESD22-A104
Pressure Cooker	JESD 22-A102
High Temp. Storage	JESD22-A103
HTRB	JESD22-A108
Thermal Shock	JESD22-A106

Flow/Wave Soldering

Peak Temperature :	265°C
Dipping Time :	10 seconds
Soldering :	1 time

Transient Voltage Suppressors - 1.5KE Series

Part Numbering System

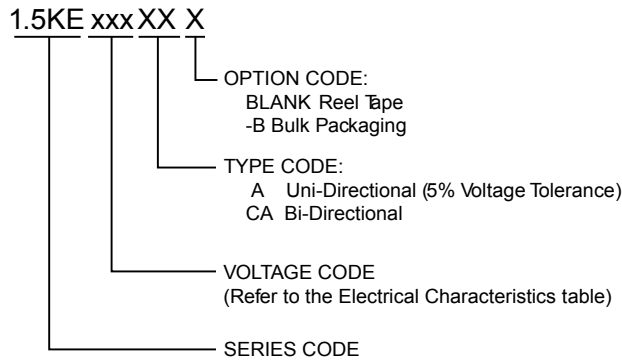

Packaging

Part Number	Component Package	Quantity	Packaging Option	Packaging Specification
1.5KExxxXX	DO-201	1000	Tape & Reel	ELA STD RS-296E
1.5KExxxXX-B	DO-201	500	BULK	Concord Packing Spec

Warehouse Storage Conditions of Products

- Storage Conditions:
 1. Storage Temperature: -10°C~+40°C
 2. Relative Humidity: ≤75%RH
 3. Keep away from corrosive atmosphere and sunlight.
- Period of Storage: 1 year

RuiLongYuan Electronics Co., Ltd.

- Reproducing and modifying information of the document is prohibited without permission from Ruilongyuan International Inc.
 - Ruilongyuan International Inc. reserves the rights to make changes of the content herein the document anytime without notification. Please refer to our website for the latest document.
 - Ruilongyuan International Inc. disclaims any and all liability arising out of the application or use of any product including damages incidentally and consequentially occurred.
 - Ruilongyuan International Inc. does not assume any and all implied warranties, including warranties of fitness for particular purpose, non-infringement and merchantability.
 - Applications shown on the herein document are examples of standard use and operation. Customers are responsible in comprehending the suitable use in particular applications. Ruilongyuan International Inc. makes no representation or warranty that such applications will be suitable for the specified use without further testing or modification.
 - The products shown herein are not designed and authorized for equipments requiring high level of reliability or relating to human life and for any applications concerning life-saving or life-sustaining, such as medical instruments, transportation equipment, aerospace machinery et cetera. Customers using or selling these products for use in such applications do so at their own risk and agree to fully indemnify Ruilongyuan International Inc. for any damages resulting from such improper use or sale.
-

X-ON Electronics

Largest Supplier of Electrical and Electronic Components

Click to view similar products for [ESD Suppressors / TVS Diodes](#) category:

Click to view products by [Ruilongyuan](#) manufacturer:

Other Similar products are found below :

[60KS200C](#) [D18V0L1B2LP-7B](#) [D5V0F4U5P5-7](#) [DESD5V0U1BB-7](#) [NTE4902](#) [P4KE27CA](#) [P6KE11CA](#) [P6KE39CA-TP](#) [P6KE8.2A](#)
[SA110CA](#) [SA60CA](#) [SA64CA](#) [SMBJ12CATR](#) [SMBJ33CATR](#) [SMBJ8.0A](#) [ESD101-B1-02ELS E6327](#) [ESD105-B1-02EL E6327](#) [ESD112-B1-02EL E6327](#) [ESD119B1W01005E6327XTSA1](#) [ESD5V0L1B02VH6327XTSA1](#) [ESD7451N2T5G](#) [19180-510](#) [CPDT-5V0USP-HF](#)
[3.0SMCJ33CA-F](#) [3.0SMCJ36A-F](#) [HSPC16701B02TP](#) [D3V3Q1B2DLP3-7](#) [D55V0M1B2WS-7](#) [DESD5V0U1BL-7B](#) [DRTR5V0U4SL-7](#)
[SCM1293A-04SO](#) [ESD200-B1-CSP0201 E6327](#) [SM12-7](#) [SMF8.0A-TP](#) [SMLJ45CA-TP](#) [CEN955 W/DATA](#) [82350120560](#) [VESD12A1A-](#)
[HD1-GS08](#) [CPDUR5V0R-HF](#) [CPDQC5V0U-HF](#) [CPDQC5V0USP-HF](#) [CPDQC5V0-HF](#) [D1213A-01LP4-7B](#) [D1213A-02WL-7](#)
[MMAD1108/TR13](#) [5KP100A](#) [5KP15A](#) [5KP18A](#) [5KP48A](#) [5KP90A](#)