

# Transient Voltage Suppressors

**5KP Series**

## Transient Voltage Suppressors - 5KP Series

### Features

- Fast response time
- Low incremental surge resistance
- Matte tin lead-free Plated
- Halogen free and RoHS compliant
- Typical IR less than 2μA above 11V
- Compatible with industrial standard package P600
- For surface mounted applications to optimize board space
- ESD protection of data lines in accordance with IEC 61000-4-2 (IEC801-2)
- EFT protection of data lines in accordance with IEC 61000-4-4 (IEC801-4)
- 5000W peak pulse power capability with at 10/1000μs waveform, repetition rate (duty cycle): 0.01%
- High temperature soldering guaranteed: 260°C/40 seconds

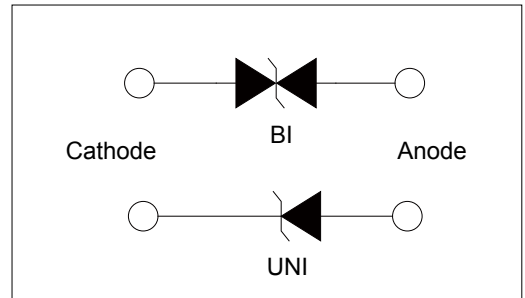

### Description

The 5KP Series is designed specifically to protect sensitive electronic equipment from voltage transients induced by lightning and other transient voltage events.

### Mechanical Characteristics

Rating	Symbol	Value	Units
Peak Pulse Power Dissipation by 10x1000μs test waveform. (Fig.2)(Note 1)	$P_{PPM}$	5000	Watts
Steady State Power Dissipation on infinite heat sink at $T_L=75^{\circ}C$ (Fig. 6)	$P_D$	8	Watts
Peak Forward Surge Current, 8.3ms Single Half Sine Wave Unidirectional only .(Note 2)	$I_{FSM}$	400	Amps
Maximum Instantaneous Forward Voltage at 25A for Unidirectional only .(Note 3)	$V_F$	3.5/5.0	V
Operating junction and Storage Temperature Range.	$T_J, T_{STG}$	-55°C to 175°C	°C
Typical Thermal Resistance Junction to Lead.	$R_{\theta JL}$	8.0	°C/W
Typical Thermal Resistance Junction to Ambient	$R_{\theta JA}$	40	°C/W

Notes:

1. Non-repetitive current pulse , per Fig. 3 and derated above  $T_A = 25^{\circ}C$  per Fig. 2.
2. Measured on 8.3ms single half sine wave or equivalent square wave, duty cycle=4 per minute maximum.
3.  $V_F < 3.5V$  for single die parts and  $V_F < 5.0V$  for stacked-die parts.

## Electrical Characteristics

Type Number		Reverse Stand-Off Voltage	Breakdown Voltage Min.@I <sub>T</sub>		Test Current	Maximum Clamping Voltage@I <sub>PP</sub>	Peak Pulse Current	Reverse Leakage @V <sub>R</sub>
UNI	BI	V <sub>R</sub> (V)	V <sub>BR</sub> MIN.(V)	V <sub>BR</sub> MAX.(V)	I <sub>T</sub> (mA)	V <sub>C</sub> (V)	I <sub>PP</sub> (A)	I <sub>R</sub> (μA)
5KP5.0A	5KP5.0CA	5.0	6.40	7.00	50	9.2	554.3	5000
5KP6.0A	5KP6.0CA	6.0	6.67	7.37	50	10.3	495.1	5000
5KP6.5A	5KP6.5CA	6.5	7.22	7.98	50	11.2	445.4	2000
5KP7.0A	5KP7.0CA	7.0	7.78	8.60	50	12.0	425.0	1000
5KP7.5A	5KP7.5CA	7.5	8.33	9.21	5	12.9	395.3	250
5KP8.0A	5KP8.0CA	8.0	8.89	9.83	5	13.6	375.0	150
5KP8.5A	5KP8.5CA	8.5	9.44	10.40	5	14.4	354.2	50
5KP9.0A	5KP9.0CA	9.0	10.00	11.10	5	15.4	331.2	20
5KP10A	5KP10CA	10.0	11.10	12.30	5	17.0	300.0	15
5KP11A	5KP11CA	11.0	12.20	13.50	5	18.2	280.2	2
5KP12A	5KP12CA	12.0	13.30	14.70	5	19.9	256.3	2
5KP13A	5KP13CA	13.0	14.40	15.90	5	21.5	237.2	2
5KP14A	5KP14CA	14.0	15.60	17.20	5	23.2	219.8	2
5KP15A	5KP15CA	15.0	16.70	18.50	5	24.4	209.0	2
5KP16A	5KP16CA	16.0	17.80	19.70	5	26.0	196.2	2
5KP17A	5KP17CA	17.0	18.90	20.90	5	27.6	184.8	2
5KP18A	5KP18CA	18.0	20.00	22.10	5	29.2	174.7	2
5KP20A	5KP20CA	20.0	22.20	24.50	5	32.4	157.4	2
5KP22A	5KP22CA	22.0	24.00	26.90	5	35.5	143.7	2
5KP24A	5KP24CA	24.0	26.70	29.50	5	38.9	131.1	2
5KP26A	5KP26CA	26.0	28.90	31.90	5	42.1	121.1	2
5KP28A	5KP28CA	28.0	31.10	34.40	5	45.4	112.3	2
5KP30A	5KP30CA	30.0	33.30	36.80	5	48.4	105.4	2
5KP33A	5KP33CA	33.0	36.70	40.60	5	53.3	95.7	2
5KP36A	5KP36CA	36.0	40.00	44.20	5	58.1	87.8	2
5KP40A	5KP40CA	40.0	44.40	49.10	5	64.5	79.1	2
5KP43A	5KP43CA	43.0	47.80	52.80	5	73.5	73.5	2
5KP45A	5KP45CA	45.0	50.00	55.30	5	72.7	70.2	2
5KP48A	5KP48CA	48.0	53.30	58.90	5	77.4	65.9	2
5KP51A	5KP51CA	51.0	56.70	62.70	5	82.4	61.9	2
5KP54A	5KP54CA	54.0	60.00	66.30	5	87.1	58.6	2
5KP58A	5KP58CA	58.0	64.40	71.20	5	93.6	54.5	2
5KP60A	5KP60CA	60.0	66.70	73.70	5	96.8	52.7	2
5KP64A	5KP64CA	64.0	71.10	78.60	5	103.0	49.5	2
5KP70A	5KP70CA	70.0	77.80	86.00	5	113.0	45.1	2
5KP75A	5KP75CA	75.0	83.30	92.10	5	121.0	42.1	2
5KP78A	5KP78CA	78.0	86.70	95.80	5	126.0	40.5	2
5KP85A	5KP85CA	85.0	94.40	104.00	5	137.0	37.2	2
5KP90A	5KP90CA	90.0	100.00	111.00	5	146.0	34.9	2
5KP100A	5KP100CA	100.0	111.00	123.00	5	162.0	31.5	2
5KP110A	5KP110CA	110.0	122.00	135.00	5	177.0	28.8	2
5KP120A	5KP120CA	120.0	133.00	147.00	5	193.0	26.4	2
5KP130A	5KP130CA	130.0	144.00	159.00	5	209.0	24.4	2
5KP150A	5KP150CA	150.0	167.00	185.00	5	243.0	21.0	2
5KP160A	5KP160CA	160.0	178.00	197.00	5	259.0	19.7	2
5KP170A	5KP170CA	170.0	189.00	209.00	5	275.0	18.5	2
5KP180A	5KP180CA	180.0	200.00	221.00	5	292.0	17.5	2
5KP190A	5KP190CA	190.0	211.00	233.00	5	310.0	16.5	2

Notes: For bidirectional type having V<sub>R</sub> of 10V and less, the I<sub>R</sub> limit is double.

## Transient Voltage Suppressors - 5KP Series

### I-V Curve Characteristics

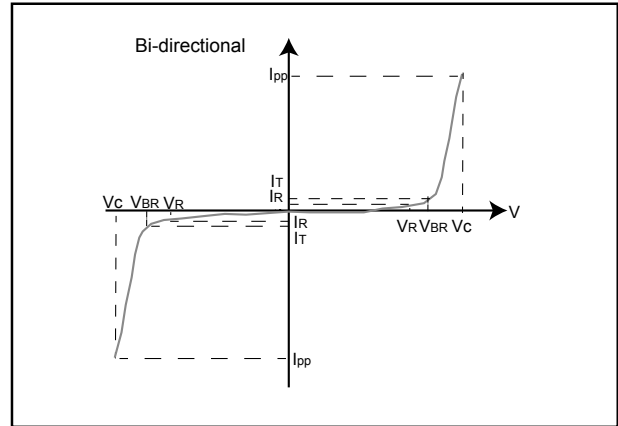
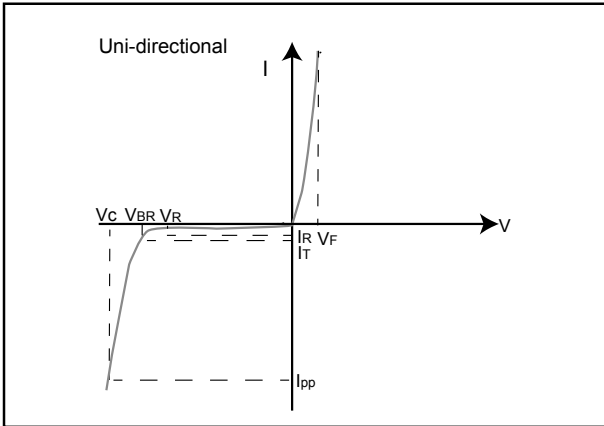

**PPM Peak Pulse Power Dissipation** -- Max power dissipation

**VR Stand-off Voltage** -- Maximum voltage that can be applied to the TVS without operation

**VBR Breakdown Voltage** -- Maximum voltage that flows through the TVS at a specified test current ( $I_T$ )

**VC Clamping Voltage** -- Peak voltage measured across the TVS at a specified  $I_{ppm}$  (peak impulse current)

**IR Reverse Leakage Current** -- Current measured at  $V_R$

**VF Forward Voltage Drop for Uni-directional**

Ratings and Characteristic Curves ( $T_A = 25^\circ \text{C}$  unless otherwise noted)

Figure 1 - TVS Transients Clamping Waveform

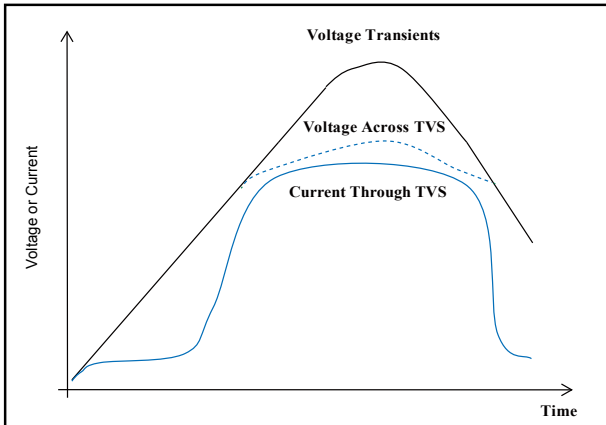
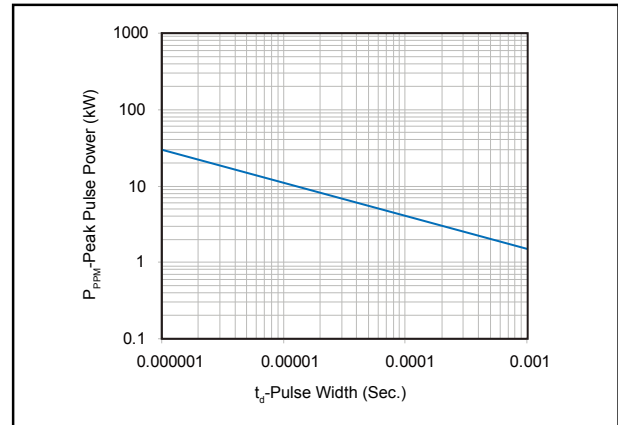

Figure 2 - Peak Pulse Power Rating



## Transient Voltage Suppressors - 5KP Series

### Ratings and Characteristic Curves (TA=25°C unless otherwise noted) (Continued)

Figure 3 - Pulse Derating Curve

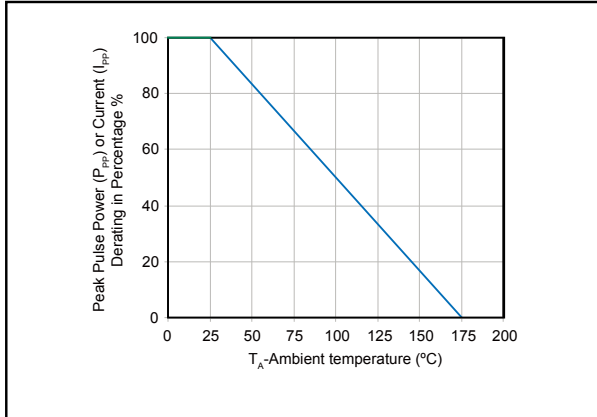

Figure 4 - Pulse Waveform

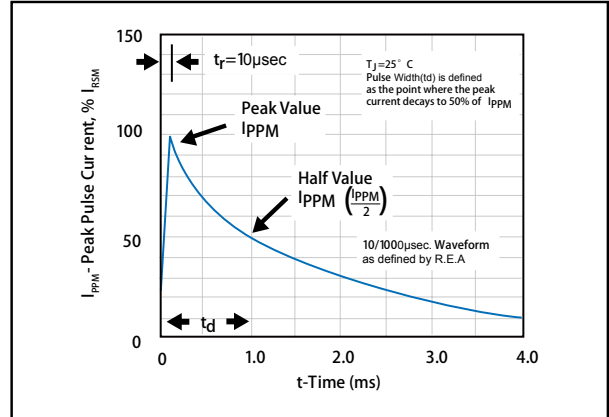

Figure 5 - Typical Junction Capacitance

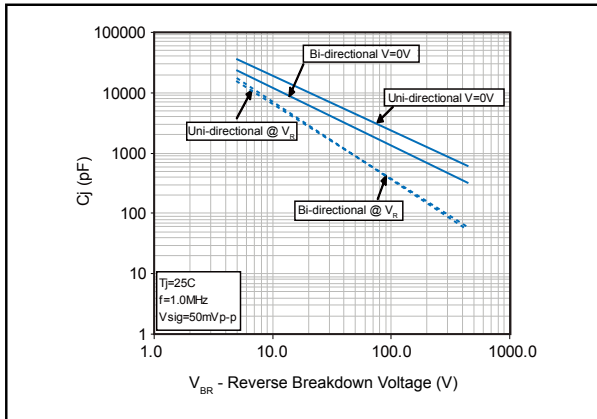

Figure 6 - Steady State Power Derating Curve

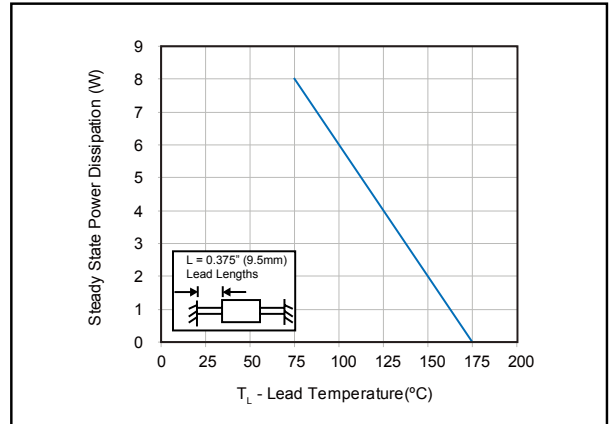
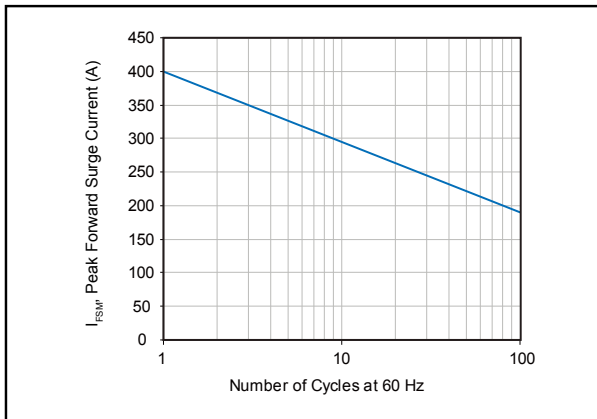

Figure 7 - Maximum Non-Repetitive Peak Forward Surge Current



## Transient Voltage Suppressors - 5KP Series

### Soldering Parameters

Reflow Condition		Lead-free assembly
Pre Heat	- Temperature Min (T <sub>s(min)</sub> )	150°C
	- Temperature Max (T <sub>s(max)</sub> )	200°C
	- Time (min to max) (t <sub>s</sub> )	60-180 secs
Average ramp up rate (Liquidus Temp (T <sub>A</sub> ) to peak)		3°C/second max
T <sub>S(max)</sub> to T <sub>A</sub> - Ramp-up Rate		3°C/second max
Reflow	- Temperature (T <sub>A</sub> ) (Liquidus)	217°C
	- Time (min to max) (t <sub>s</sub> )	60-150 seconds
Peak Temperature (T <sub>p</sub> )		260 <sup>+0/-5</sup> °C
Time within 5°C of actual peak Temperature (t <sub>p</sub> )		20-40 seconds
Ramp-down Rate		6°C/second max
Time 25°C to peak Temperature (T <sub>p</sub> )		8 minutes Max.
Do not exceed		280°C

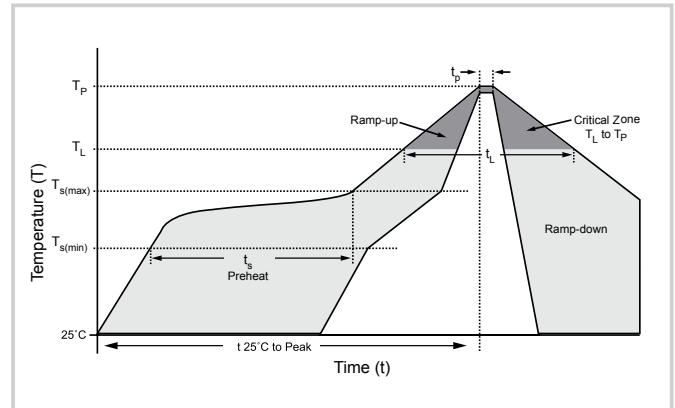

### Environmental Specifications

High Temp. Storage JESD22-A103	JESD22-A104
HTRB JESD22-A108	JESD 22-A102
Temperature Cycling JESD22-A104	JESD22-A103
H3TRB JESD22-A101	JESD22-A108
RSH JESD22-B106	JESD22-A106

### Physical Specifications

Weight	0.07oz., 2.1g
Case	P600 molded plastic body over passivated junction.
Polarity	Color band denotes cathode except Bidirectional.
Terminals	Matte Tin axial leads, solderable per JESD22-B102D.

### Flow/Wave Soldering

Peak Temperature :	265°C
Dipping Time :	10 seconds
Soldering :	1 time

### Dimensions P600

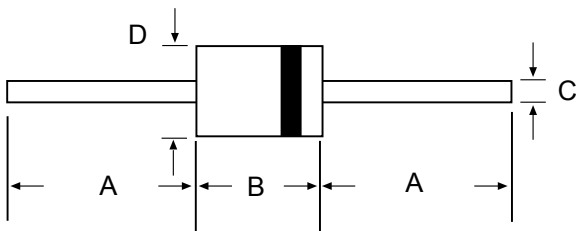

DIM	Inches		Millimeters	
	Min	Max	Min	Max
A	1.000	-	25.40	-
B	0.340	0.360	8.60	9.10
C	0.048	0.052	1.22	1.32
D	0.340	0.360	8.60	9.10

## Transient Voltage Suppressors - 5KP Series

### Product Name

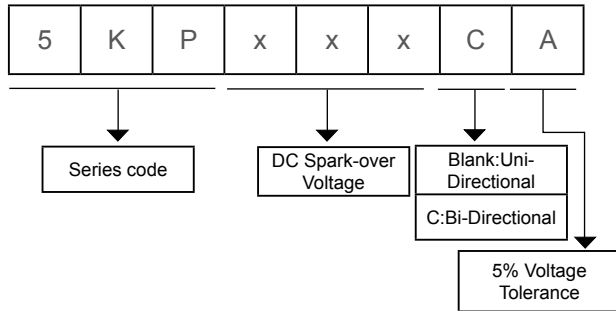

### Part Marking System

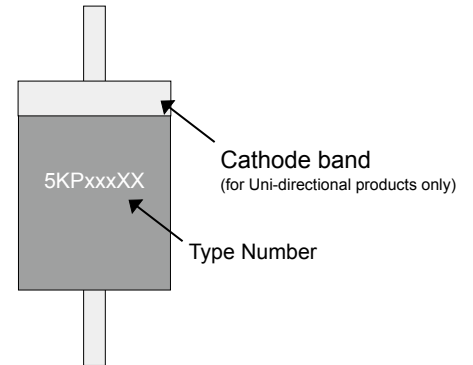

### Packaging

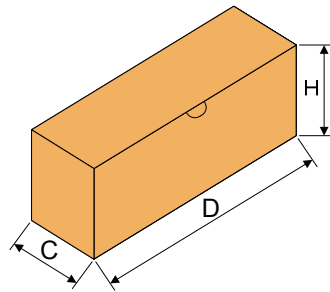
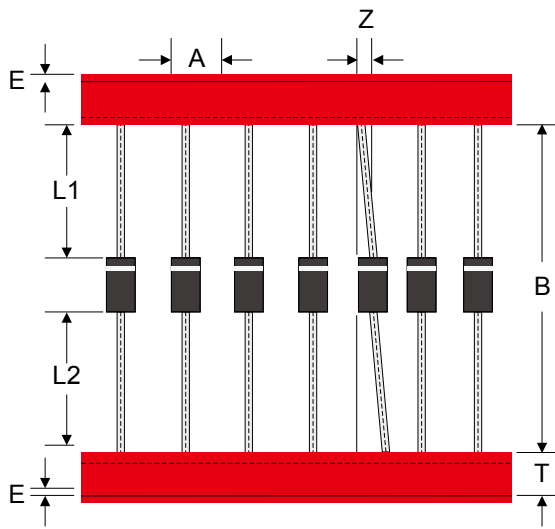

Symbol	Dimension (mm)
A	10.0±0.5
B	53.0±1.0
Z	1.2Max
T	6.0±0.4
E	0.8Max
L1-L2	1.0Max
D	250.0±5.0
C	75.0±5.0
H	114.0±5.0
Quantity	400PCS

## X-ON Electronics

Largest Supplier of Electrical and Electronic Components

*Click to view similar products for [ESD Suppressors / TVS Diodes](#) category:*

*Click to view products by [Ruilongyuan](#) manufacturer:*

Other Similar products are found below :

[60KS200C](#) [D18V0L1B2LP-7B](#) [D5V0F4U5P5-7](#) [DESD5V0U1BB-7](#) [NTE4902](#) [P4KE27CA](#) [P6KE11CA](#) [P6KE39CA-TP](#) [P6KE8.2A](#)  
[SA110CA](#) [SA60CA](#) [SA64CA](#) [SMBJ12CATR](#) [SMBJ33CATR](#) [SMBJ8.0A](#) [ESD101-B1-02ELS E6327](#) [ESD105-B1-02EL E6327](#) [ESD112-B1-02EL E6327](#) [ESD119B1W01005E6327XTSA1](#) [ESD5V0L1B02VH6327XTSA1](#) [ESD7451N2T5G](#) [19180-510](#) [CPDT-5V0USP-HF](#)  
[3.0SMCJ33CA-F](#) [3.0SMCJ36A-F](#) [HSPC16701B02TP](#) [D3V3Q1B2DLP3-7](#) [D55V0M1B2WS-7](#) [DESD5V0U1BL-7B](#) [DRTR5V0U4SL-7](#)  
[SCM1293A-04SO](#) [ESD200-B1-CSP0201 E6327](#) [SM12-7](#) [SMF8.0A-TP](#) [SMLJ45CA-TP](#) [CEN955 W/DATA](#) [82350120560](#) [VESD12A1A-](#)  
[HD1-GS08](#) [CPDUR5V0R-HF](#) [CPDQC5V0U-HF](#) [CPDQC5V0USP-HF](#) [CPDQC5V0-HF](#) [D1213A-01LP4-7B](#) [D1213A-02WL-7](#)  
[MMAD1108/TR13](#) [5KP100A](#) [5KP15A](#) [5KP18A](#) [5KP48A](#) [5KP90A](#)