

ES2A THRU ES2J

Super Fast Recovery Rectifier Diode

Features

- Low profile package
- Ideal for automated placement
- Glass passivated chip junction
- Super fast reverse recovery time
- High forward surge capability
- Meets MSL level 1, per J-STD-020,LF maximum peak of 260 °C



Typical Application

For use in high frequency rectification of power supply, inverters, converters, and freewheeling diodes for consumer and telecommunication.

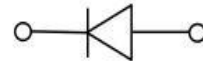

Mechanical Data

- Package: DO-214AA(SMB)
Molding compound meets UL 94 V-0 flammability rating,RoHS-compliant
- Terminals: Tin plated leads, solderable per J-STD-002 and JESD22-B102
- Polarity: Cathode line denotes the cathode end

Maximum Ratings (Ta=25°C Unless otherwise specified)

PARAMETER	Symbol	Unit	Conditions	ES2				
				A	B	D	G	J
Repetitive Peak Reverse Voltage	V_{RRM}	V		50	100	200	400	600
Average Forward Current	I_o	A	Half-sine wave, Resistance load, Ta(Fig 1)	2.0				
Surge(Nonrepetitive)Forward Current	I_{FSM}	A	60HZ sine wave, 1 cycle, Ta=25°C	50				
Current Squared Time	I^2t	A ² s	1ms≤t<8.3ms Tj=25°C,Rating of per diode	10.4				
Thermal Resistance	$R_{\theta J-A}$	°C/W	Between junction and case	75				
Storage Temperature	T_{stg}	°C		-55 ~ +150				
Junction Temperature	T_j	°C		-55 ~ +150				

Electrical Characteristics (Ta=25°C Unless otherwise specified)

PARAMETER	Symbol	Unit	Conditions	ES2				
				A	B	D	G	J
Peak Forward Voltage	V_{FM}	V	$I_F = 1.0A$	0.95			1.3	1.7
Peak Reverse Current	I_{RRM1}	μA	$V_{RM} = V_{RRM}$	Ta=25°C				
	I_{RRM2}			Ta=125°C				
Maximum reverse recovery time	T_{rr}	ns	$I_F = 0.5A, I_R = 1.0A, I_{rr} = 0.25A$	35				



ES2A THRU ES2J

■ Characteristics (Typical)

FIG1: Forward Current Derating Curve

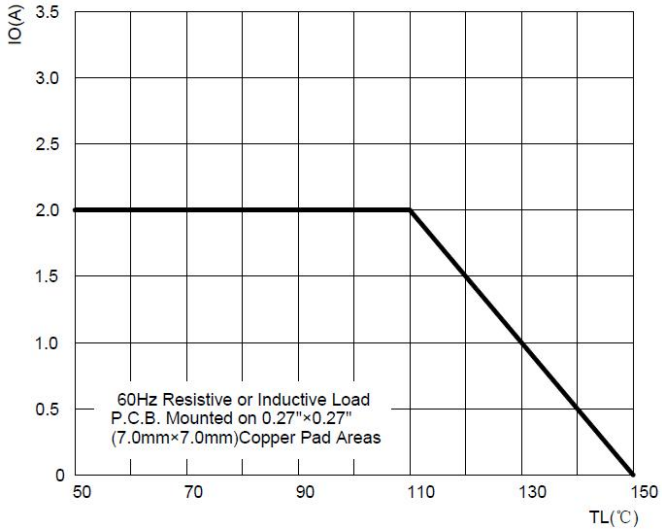

FIG2: Surge Forward Current Capability

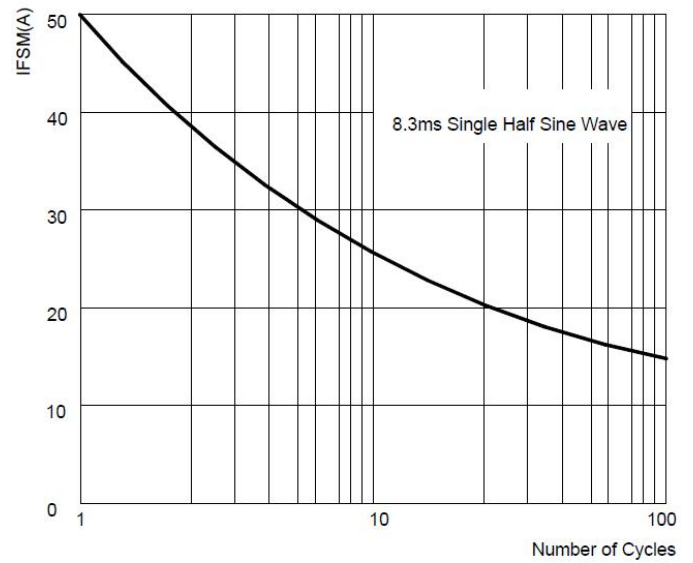

FIG3: Instantaneous Forward Voltage

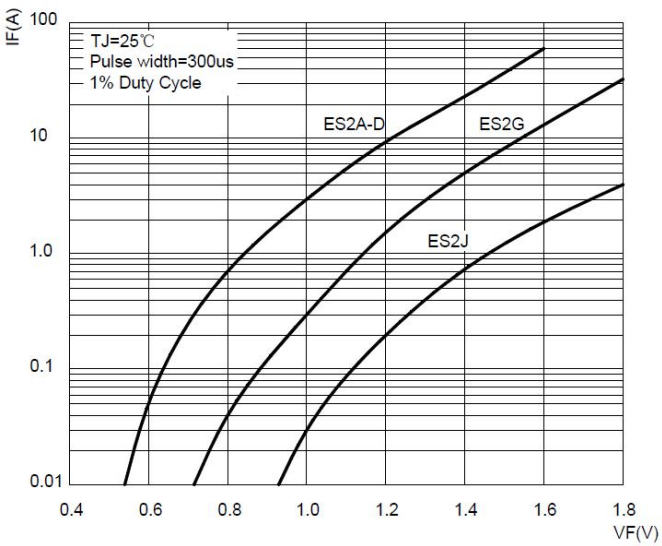

FIG4: Typical Reverse Characteristics

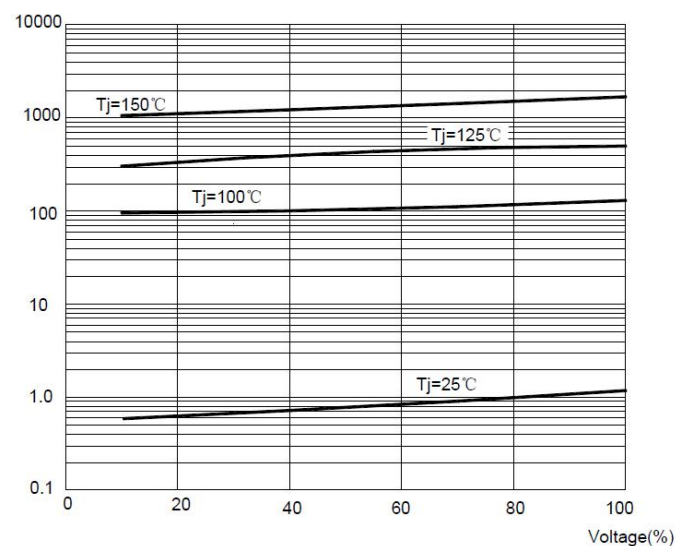
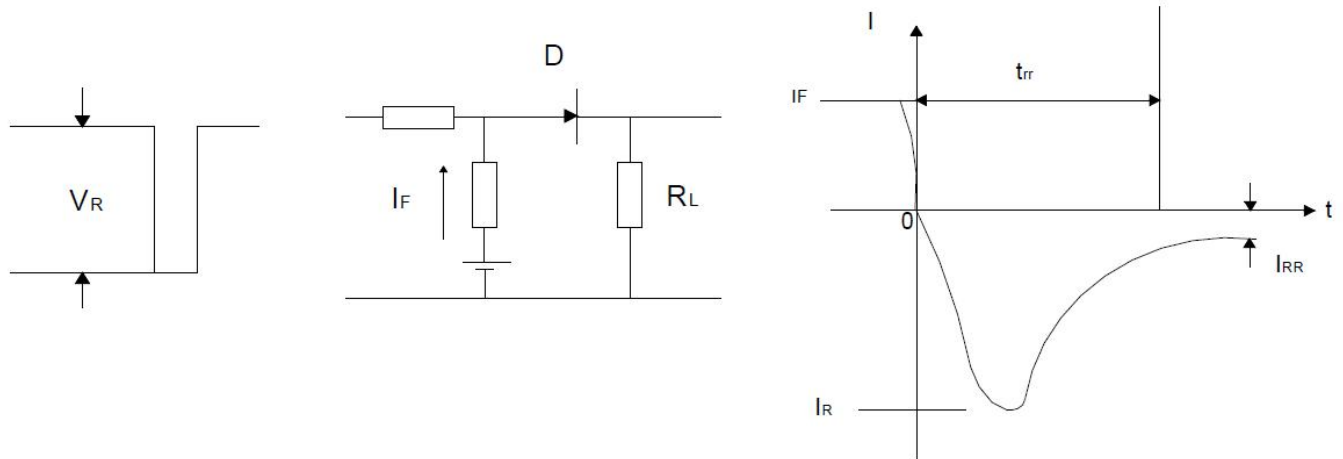

Diagram of circuit and Testing wave form of reverse recovery time



ES2A THRU ES2J

■ Ordering Information (Example)

PREFERED	PACKAGE CODE	MINIMUM PACKAGE(pcs)	INNER BOX QUANTITY(pcs)	OUTER CARTON QUANTITY(pcs)	DELIVERY MODE
ES2A~ES2J	DO-214AC(SMB)	3000	6000	48000	13" reel

■ Outline Dimensions

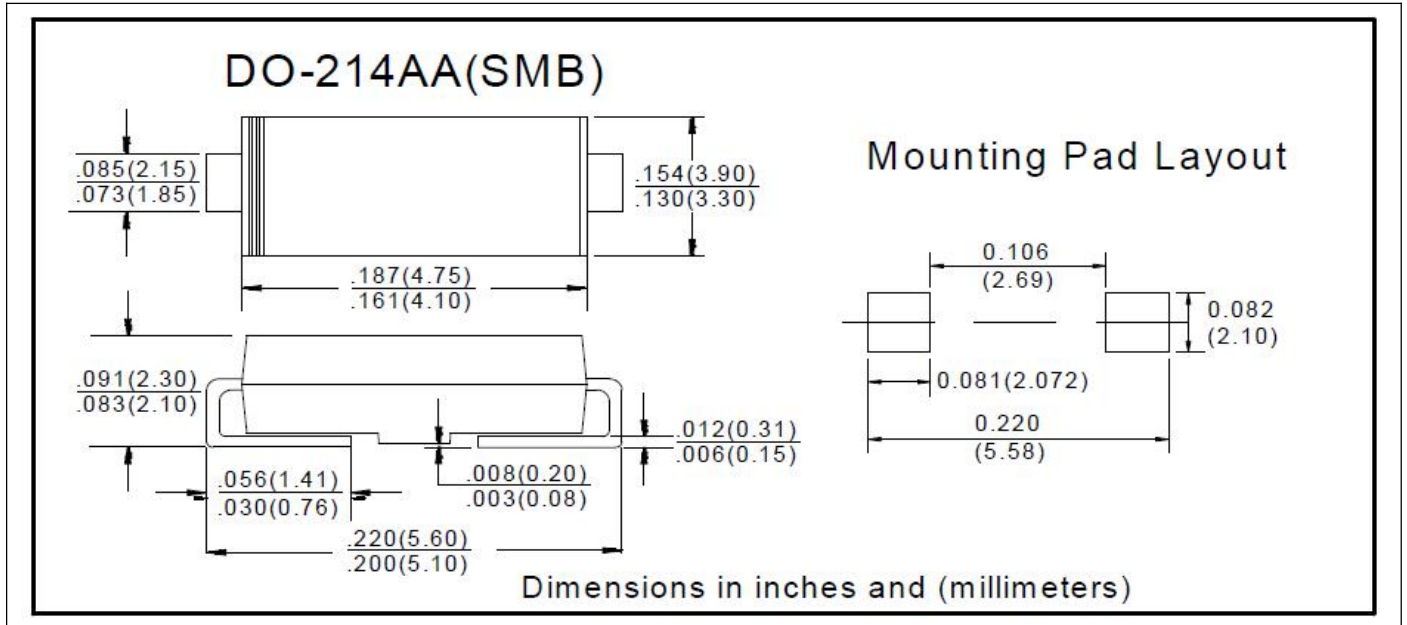

X-ON Electronics

Largest Supplier of Electrical and Electronic Components

Click to view similar products for [Rectifiers](#) category:

Click to view products by [Ruilongyuan](#) manufacturer:

Other Similar products are found below :

[70HFR40](#) [FR105 R0](#) [RL252-TP](#) [1N5397](#) [1N4005-TR](#) [1N4007-BP](#) [UFS120Je3/TR13](#) [20ETS12S](#) [RRE02VS6SGTR](#) [MS306](#) [A1N5404G-G](#)
[CRF02\(T5L,TEMQ\)](#) [ACGRB207-HF](#) [CLH07\(TE16L,Q\)](#) [CLH03\(TE16L,Q\)](#) [1N5395-TP](#) [UES1302](#) [ACGRC307-HF](#) [ACEFC304-HF](#) [DZ-](#)
[1380](#) [85HFR60](#) [40HFR60](#) [70HF120](#) [85HFR80](#) [SCF7500](#) [SM100](#) [ACGRA4001-HF](#) [SKN70/08](#) [NTE5819](#) [NTE5827](#) [NTE5828](#) [NTE5911](#)
[NTE5915](#) [NTE6104](#) [NTE6163](#) [NTE6164](#) [NTE6165](#) [NTE6364](#) [TSD3G](#) [SET130312](#) [NRVUS110VT3G](#) [UES1106](#) [UES1306](#)
[NRVUS240VT3G](#) [D5FE60-5063](#) [R4000GPS-TP](#) [D4015L56TP](#) [UES1306HR2](#) [FX20K120](#) [D20XB60-7101](#)