

ES3A THRU ES3J

Super Fast Recovery Rectifier Diode

Features

- Low profile package
- Ideal for automated placement
- Glass passivated chip junction
- Super fast reverse recovery time
- High forward surge capability
- Meets MSL level 1, per J-STD-020,LF maximum peak of 260 °C



Typical Application

For use in high frequency rectification of power supply, inverters, converters, and freewheeling diodes for consumer and telecommunication.

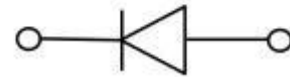

Mechanical Data

- Package: DO-214AB(SMC)
Molding compound meets UL 94 V-0 flammability rating,RoHS-compliant
- Terminals: Tin plated leads, solderable per J-STD-002 and JESD22-B102
- Polarity: Cathode line denotes the cathode end

Maximum Ratings (Ta=25°C Unless otherwise specified)

PARAMETER	Symbol	Unit	Conditions	ES3							
				A	B	C	D	F	G	H	J
Repetitive Peak Reverse Voltage	V_{RRM}	V		50	100	150	200	300	400	500	600
Average Forward Current	$I_{F(AV)}$	A	60Hz Half-sine wave, Resistance load, $T_L=100^\circ\text{C}$	3.0							
Surge(Nonrepetitive)Forward Current	I_{FSM}	A	60HZ Half-sine wave, 1 cycle, $T_a=25^\circ\text{C}$	100							
Storage Temperature	T_{stg}	°C		-55 ~ +150							
Junction Temperature	T_j	°C		-55 ~ +150							

Electrical Characteristics (Ta=25°C Unless otherwise specified)

PARAMETER	Symbol	Unit	Conditions	ES3							
				A	B	C	D	F	G	H	J
Peak Forward Voltage	V_{FM}	V	$I_F=3.0A$	0.95			1.3		1.7		
Peak Reverse Current	I_{RRM1}	μA	$V_{RM}=V_{RRM}$	$T_a=25^\circ\text{C}$							
	I_{RRM2}			$T_a=125^\circ\text{C}$							
Maximum reverse recovery time	T_{rr}	ns	$I_F=0.5A, I_R=1.0A, I_{rr}=0.25A$	35							
Thermal Resistance(Typical)	$R_{\theta J-A}$	°C/W	Between junction and ambient	47 ¹⁾							
	$R_{\theta J-L}$		Between junction and terminal	12 ¹⁾							

Notes:

¹⁾ Thermal resistance from junction to ambient and from junction to lead mounted on P.C.B. with 0.3" x 0.3" (8.0 mm x 8.0 mm) copper pad areas



ES3A THRU ES3J

■ Characteristics (Typical)

FIG1: Forward Current Derating Curve

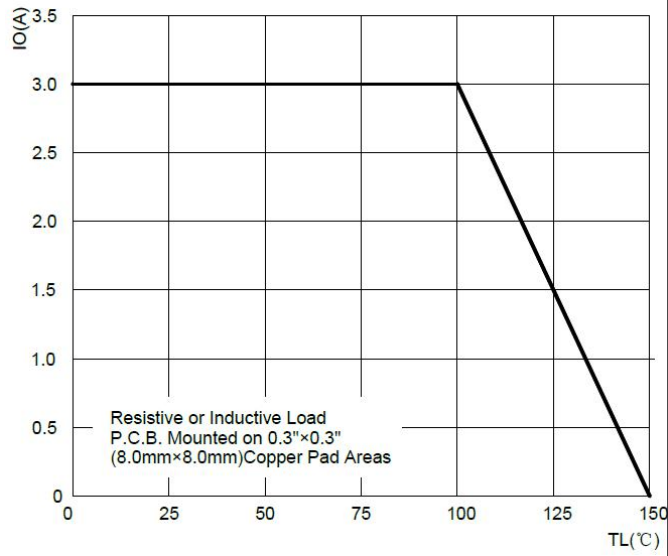

FIG2: Maximum Non-Repetitive Forward Surge Current

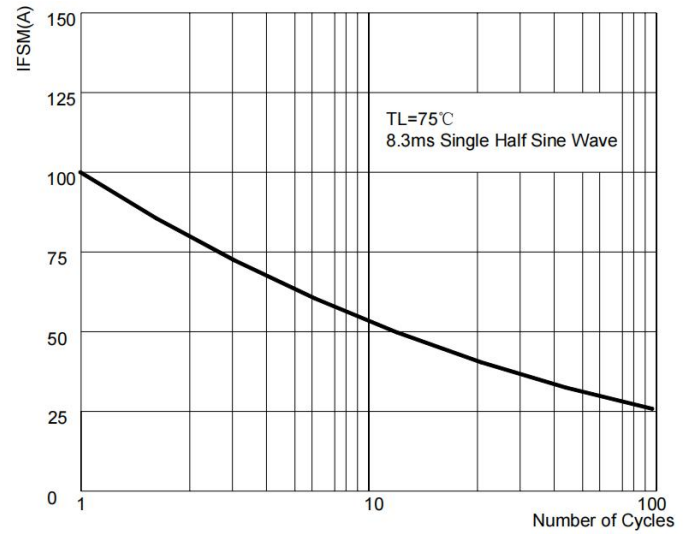

FIG3: Typical Forward Characteristics

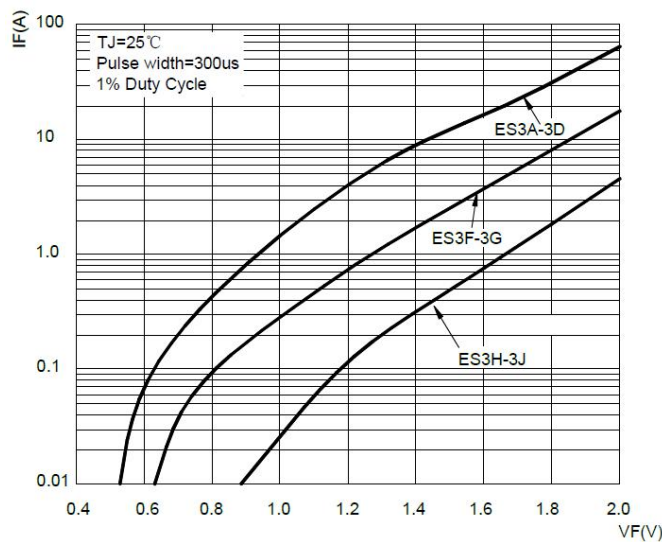

FIG4: Typical Reverse Characteristics

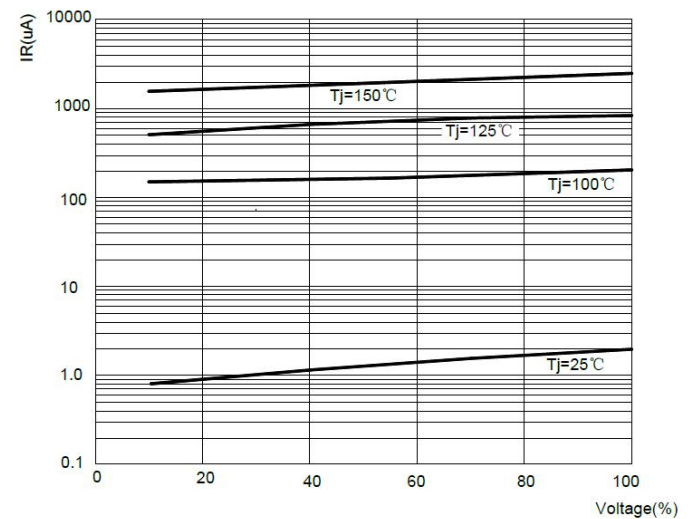
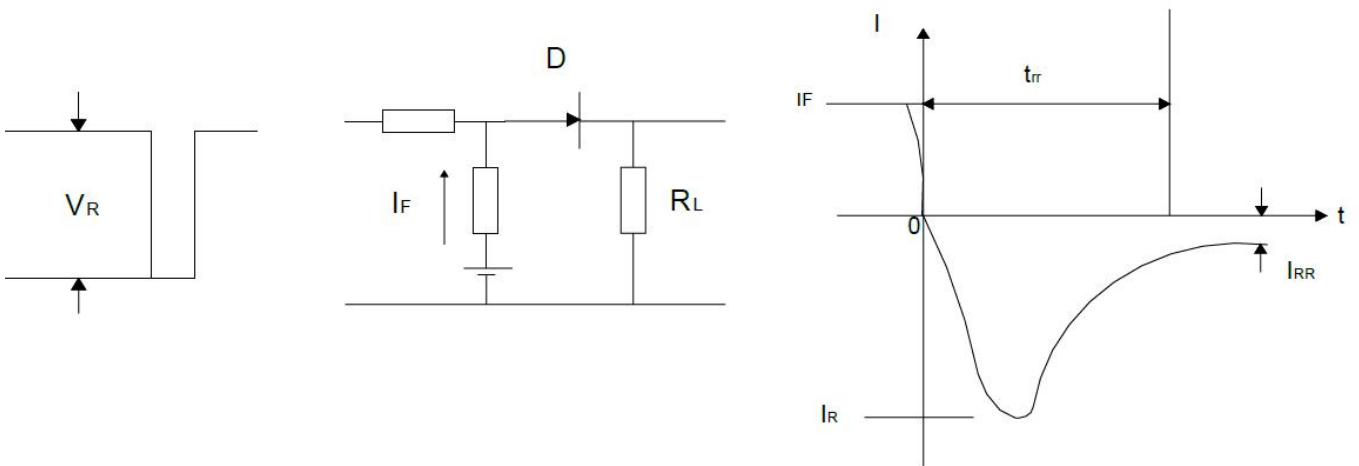

FIG5: Diagram of circuit and Testing wave form of reverse recovery time



ES3A THRU ES3J

Ordering Information (Example)

PREFERED	PACKAGE CODE	MINIMUM PACKAGE(pcs)	INNER BOX QUANTITY(pcs)	OUTER CARTON QUANTITY(pcs)	DELIVERY MODE
ES3A~ES3J	DO-214AB(SMC)	3000	6000	42000	13" reel
ES3A~ES3J	DO-214AB(SMC)	500	1500	15000	7" reel

Outline Dimensions

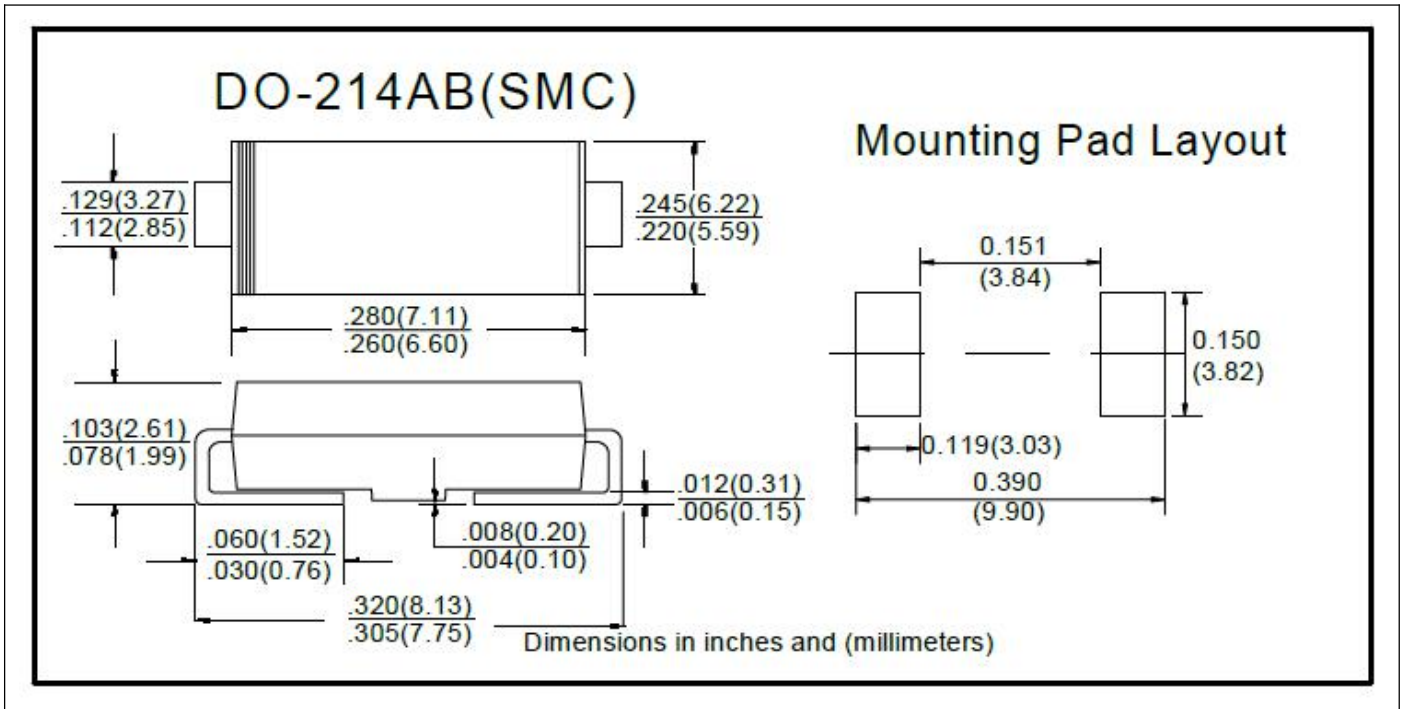

X-ON Electronics

Largest Supplier of Electrical and Electronic Components

Click to view similar products for [Rectifiers](#) category:

Click to view products by [Ruilongyuan](#) manufacturer:

Other Similar products are found below :

[70HFR40](#) [FR105 R0](#) [RL252-TP](#) [1N5397](#) [1N4005-TR](#) [1N4007-BP](#) [UFS120Je3/TR13](#) [20ETS12S](#) [RRE02VS6SGTR](#) [MS306](#) [A1N5404G-G](#)
[CRF02\(T5L,TEMQ\)](#) [ACGRB207-HF](#) [CLH07\(TE16L,Q\)](#) [CLH03\(TE16L,Q\)](#) [1N5395-TP](#) [UES1302](#) [ACGRC307-HF](#) [ACEFC304-HF](#) [DZ-](#)
[1380](#) [85HFR60](#) [40HFR60](#) [70HF120](#) [85HFR80](#) [SCF7500](#) [SM100](#) [ACGRA4001-HF](#) [SKN70/08](#) [NTE5819](#) [NTE5827](#) [NTE5828](#) [NTE5911](#)
[NTE5915](#) [NTE6104](#) [NTE6163](#) [NTE6164](#) [NTE6165](#) [NTE6364](#) [TSD3G](#) [SET130312](#) [NRVUS110VT3G](#) [UES1106](#) [UES1306](#)
[NRVUS240VT3G](#) [D5FE60-5063](#) [R4000GPS-TP](#) [D4015L56TP](#) [UES1306HR2](#) [FX20K120](#) [D20XB60-7101](#)