

ES5A THRU ES5J

Super Fast Recovery Rectifier Diode

Features

- Low profile package
- Ideal for automated placement
- Glass passivated chip junction
- Super fast reverse recovery time
- High forward surge capability
- Meets MSL level 1, per J-STD-020,LF maximum peak of 260 °C



Typical Application

For use in high frequency rectification of power supply, inverters, converters, and freewheeling diodes for consumer and telecommunication.

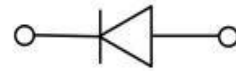

Mechanical Data

- Package: DO-214AB(SMC)
Molding compound meets UL 94 V-0 flammability rating,RoHS-compliant
- Terminals: Tin plated leads, solderable per J-STD-002 and JESD22-B102
- Polarity: Cathode line denotes the cathode end

Maximum Ratings (Ta=25°C Unless otherwise specified)

PARAMETER	Symbol	Unit	Conditions	ES5							
				A	B	C	D	F	G	H	J
Repetitive Peak Reverse Voltage	V_{RRM}	V		50	100	150	200	300	400	500	600
Average Forward Current	$I_{F(AV)}$	A	60Hz Half-sine wave, Resistance load, Ta=50°C	5.0							
Surge(Nonrepetitive)Forward Current	I_{FSM}	A	60HZ Half-sine wave, 1 cycle, Ta=25°C	120							
Storage Temperature	T_{stg}	°C		-55 ~ +150							
Junction Temperature	T_j	°C		-55 ~ +150							

Electrical Characteristics (Ta=25°C Unless otherwise specified)

PARAMETER	Symbol	Unit	Conditions	ES5							
				A	B	C	D	F	G	H	J
Peak Forward Voltage	V_{FM}	V	$I_{FM} = 5.0A$	0.95			1.3		1.7		
Peak Reverse Current	I_{RRM1}	μA	$V_{RM} = V_{RRM}$	Ta=25°C		10					
	I_{RRM2}			Ta=125°C		500					
Maximum reverse recovery time	T_{rr}	ns	$I_F = 0.5A, I_R = 1.0A, I_{rr} = 0.25A$	35							
Thermal Resistance(Typical)	$R_{\theta J-A}$	°C/W	Between junction and ambient	50 ¹⁾							
	$R_{\theta J-L}$		Between junction and lead	15 ¹⁾							

Notes:

¹⁾ Thermal resistance from junction to ambient and from junction to lead mounted on P.C.B. with 0.3" x 0.3" (8.0 mm x 8.0 mm) copper pad areas



ES5A THRU ES5J

■ Characteristics (Typical)

FIG1: Forward Current Derating Curve

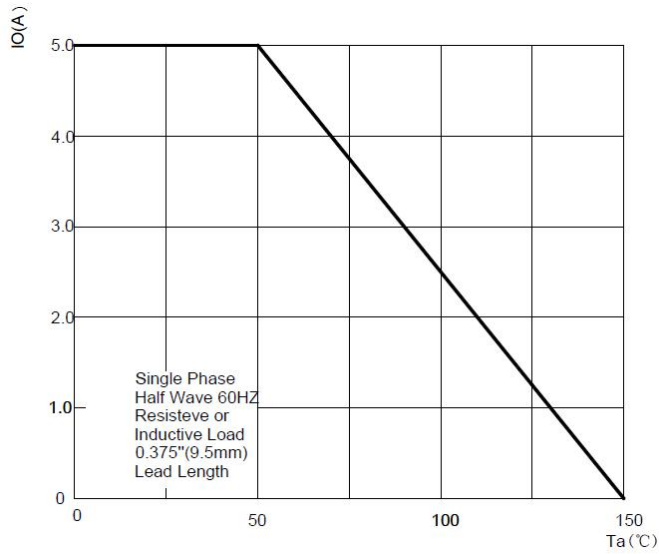

FIG2: Maximum Non-Repetitive Forward Surge Current

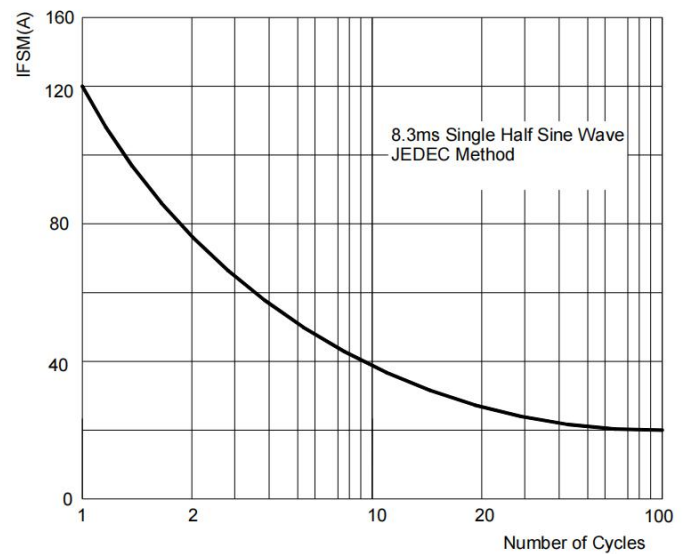

FIG3: Typical Forward Characteristics

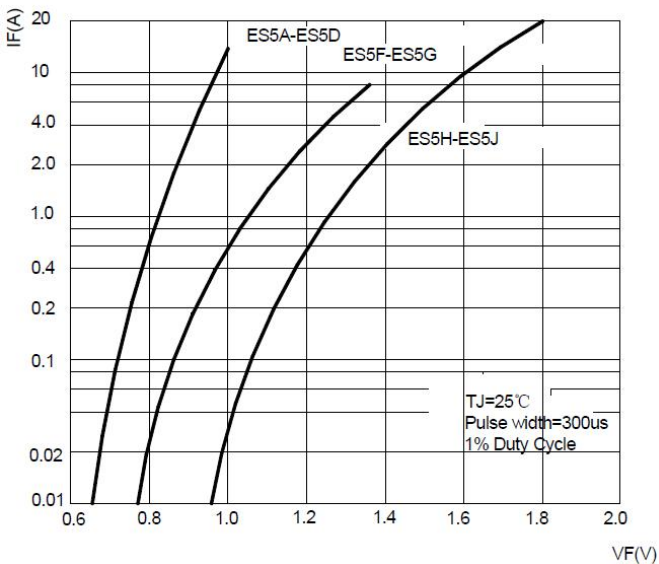

FIG4: Typical Reverse Characteristics

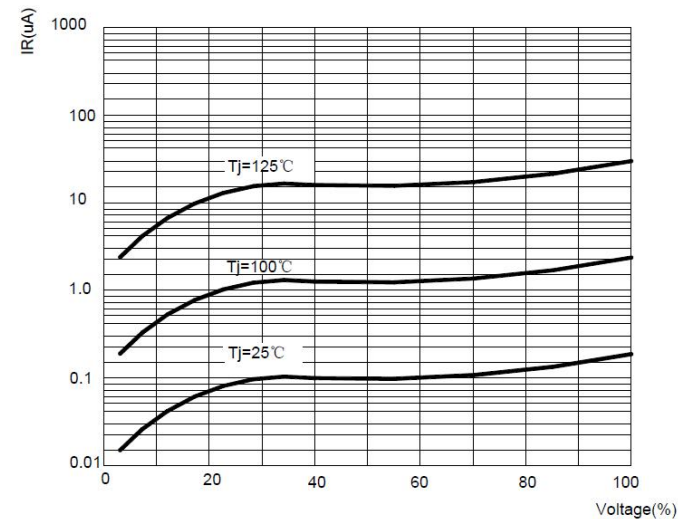
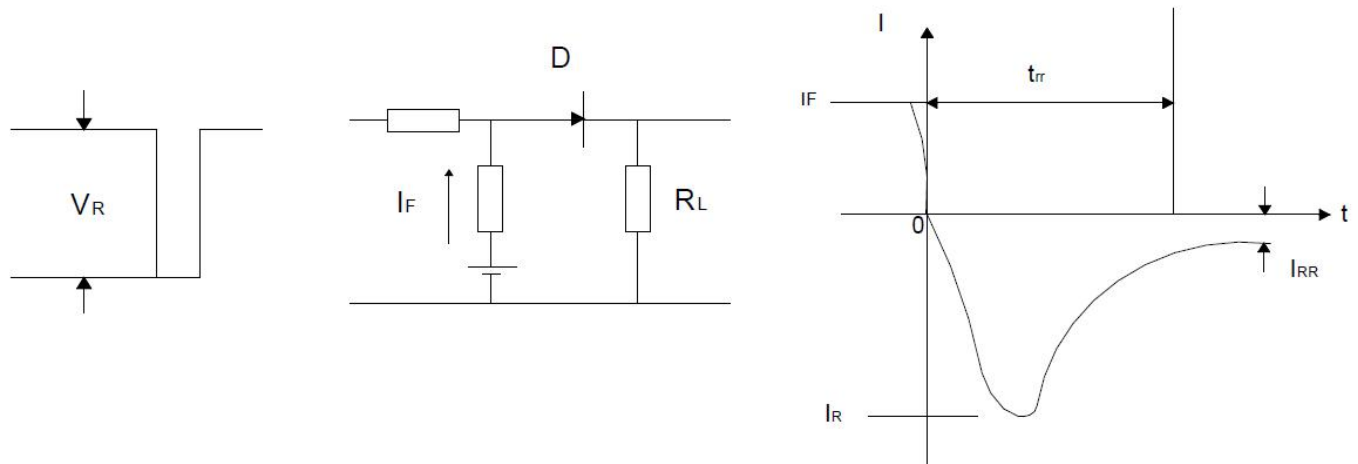

FIG5: Diagram of circuit and Testing wave form of reverse recovery time



ES5A THRU ES5J

■ Ordering Information (Example)

PREFERED	PACKAGE CODE	MINIMUM PACKAGE(pcs)	INNER BOX QUANTITY(pcs)	OUTER CARTON QUANTITY(pcs)	DELIVERY MODE
ES5A~ES5J	DO-214AB(SMC)	3000	6000	42000	13" reel

■ Outline Dimensions

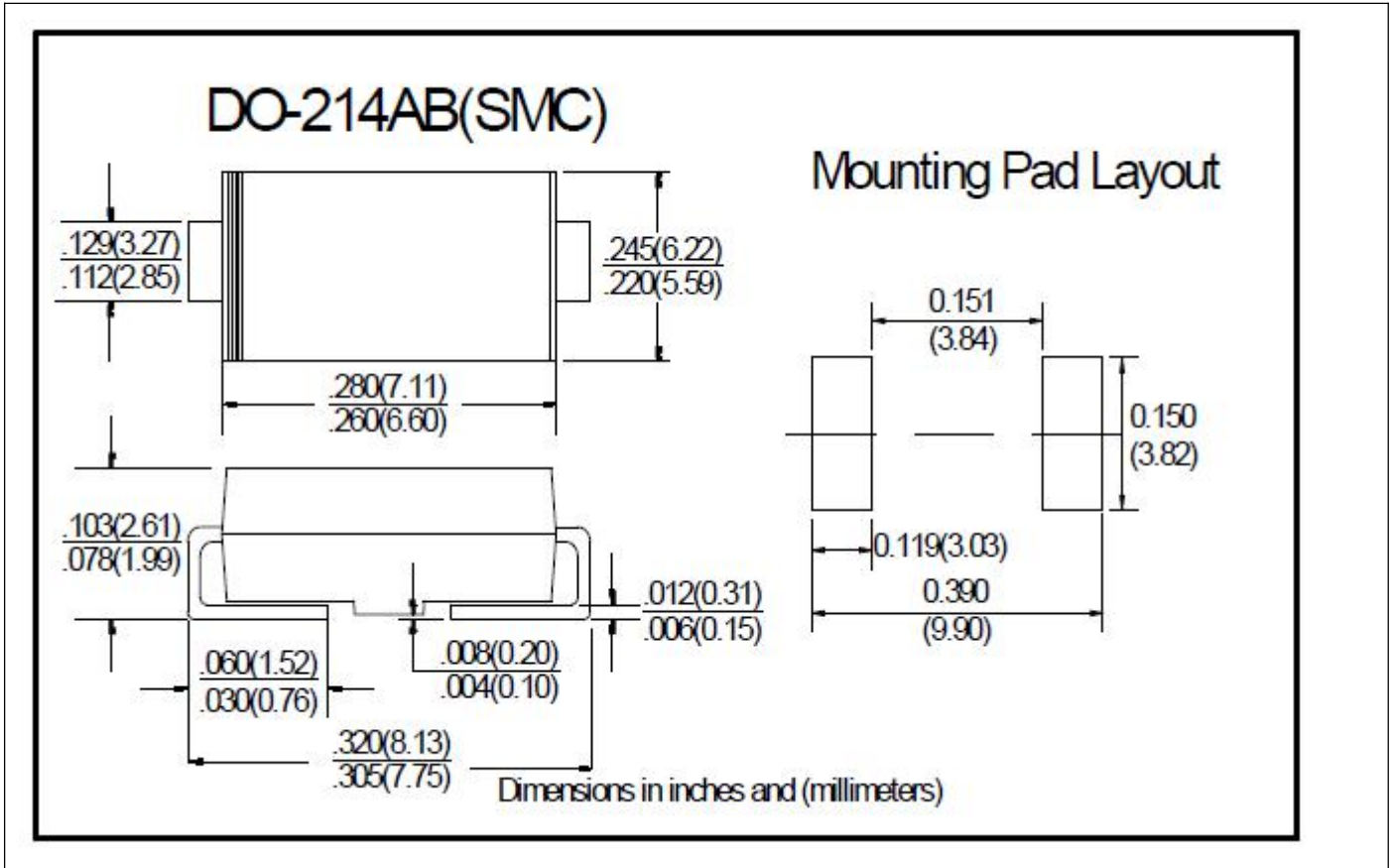

X-ON Electronics

Largest Supplier of Electrical and Electronic Components

Click to view similar products for [Rectifiers](#) category:

Click to view products by [Ruilongyuan](#) manufacturer:

Other Similar products are found below :

[70HFR40](#) [FR105 R0](#) [RL252-TP](#) [1N5397](#) [JANTX1N5634A](#) [1N4002G](#) [1N4005-TR](#) [JANS1N6640US](#) [481235F](#) [RRE02VS6SGTR](#) [067907F](#)
[MS306](#) [US2JFL-TP](#) [A1N5404G-G](#) [CRS12\(T5L,TEMQ\)](#) [ACGRB207-HF](#) [CLH07\(TE16L,Q\)](#) [CLH03\(TE16L,Q\)](#) [ACGRC307-HF](#)
[ACEFC304-HF](#) [DZ-1380](#) [NTE6356](#) [NTE6359](#) [JAN1N5555](#) [85HFR60](#) [40HFR60](#) [70HF120](#) [85HFR80](#) [D126A45C](#) [SCF7500](#) [SCHJ22.5K](#)
[SM100](#) [SCPA2](#) [SDHD5K](#) [ACGRA4001-HF](#) [D1821SH45T PR](#) [D1251S45T](#) [NTE6358](#) [NTE5850](#) [NTE5819](#) [NTE5837](#) [NTE5892](#) [NTE5900](#)
[NTE5911](#) [NTE5915](#) [NTE5921](#) [NTE6104](#) [NTE6105](#) [NTE6154](#) [NTE6158](#)