

# HS1A THRU HS1M

## High Efficient Rectifier Diode

### Features

- Low profile package
- Ideal for automated placement
- Glass passivated chip junction
- High frequency
- High forward surge capability
- Meets MSL level 1, per J-STD-020,LF maximum peak of 260 °C



### Typical Application

For use in high frequency rectification of power supply, inverters, converters, and freewheeling diodes for consumer and telecommunication.

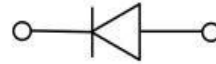

### Mechanical Data

- Package: DO-214AC(SMA)  
Molding compound meets UL 94 V-0 flammability rating,RoHS-compliant
- Terminals: Tin plated leads, solderable per J-STD-002 and JESD22-B102
- Polarity: Cathode line denotes the cathode end

### Maximum Ratings (Ta=25°C Unless otherwise specified)

PARAMETER	Symbol	Unit	Conditions	HS1							
				A	B	D	F	G	J	K	M
Repetitive Peak Reverse Voltage	$V_{RRM}$	V		50	100	200	300	400	600	800	1000
Average Forward Current	$I_{F(AV)}$	A		1.0							
Surge(Non-repetitive)Forward Current	$I_{FSM}$	A	60HZ sine wave, 1 cycle, Ta=25°C	30							
Storage Temperature	$T_{stg}$	°C		-55 ~ +150							
Junction Temperature	$T_j$	°C		-55 ~ +150							

### Electrical Characteristics (Ta=25°C Unless otherwise specified)

PARAMETER	Symbol	Unit	Conditions	HS1					
				A	B	D	F	G	J
Peak Forward Voltage	$V_{FM}$	V	$I_F = 1.0A$	1.0		1.3		1.7	
Peak Reverse Current	$I_{RRM1}$	$\mu A$	$V_{RM} = V_{RRM}$	10					
	$I_{RRM2}$			100					
Maximum reverse recovery time	$T_{rr}$	ns	$I_F = 0.5A$ $I_R = 1A$ $I_{RR} = 0.25A$	50				75	
Thermal Resistance(Typical)	$R_{\theta J-A}$	°C/W	Between junction and ambient	75 <sup>1)</sup>					
	$R_{\theta J-L}$		Between junction and terminal	27 <sup>1)</sup>					

### Notes:

1) Thermal resistance from junction to ambient and from junction to lead mounted on P.C.B. with 0.2" x 0.2" (5.0 mm x 5.0 mm) copper pad areas.



# HS1A THRU HS1M

## ■ Characteristics (Typical)

**FIG1: Forward Current Derating Curve**

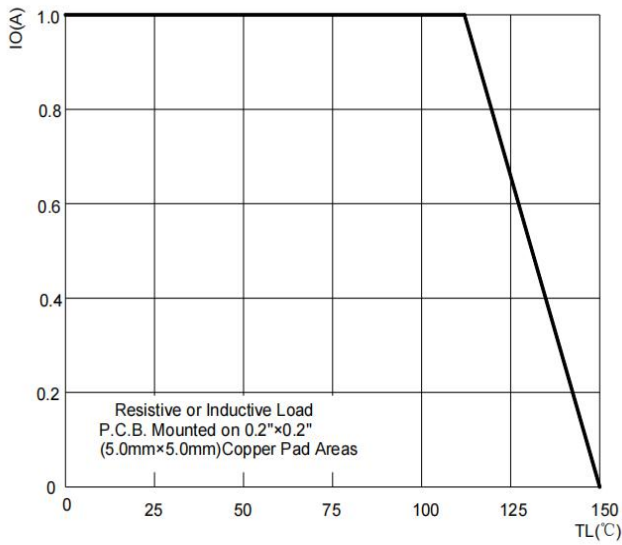

**FIG2: Surge Forward Current Capability**

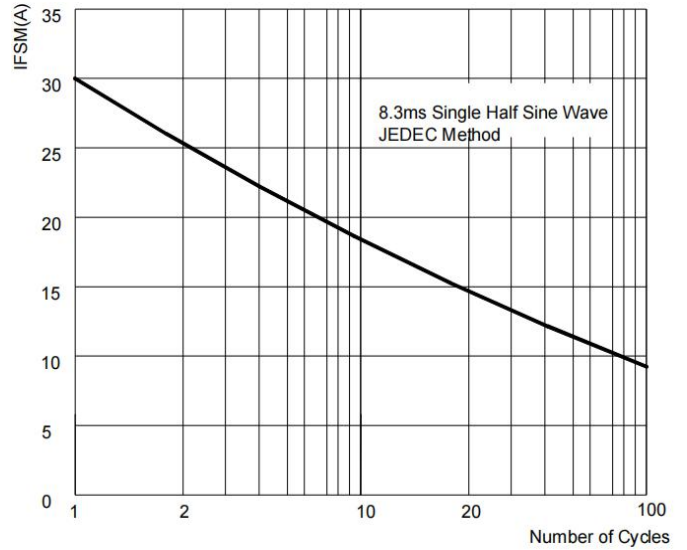

**FIG3: Instantaneous Forward Voltage**

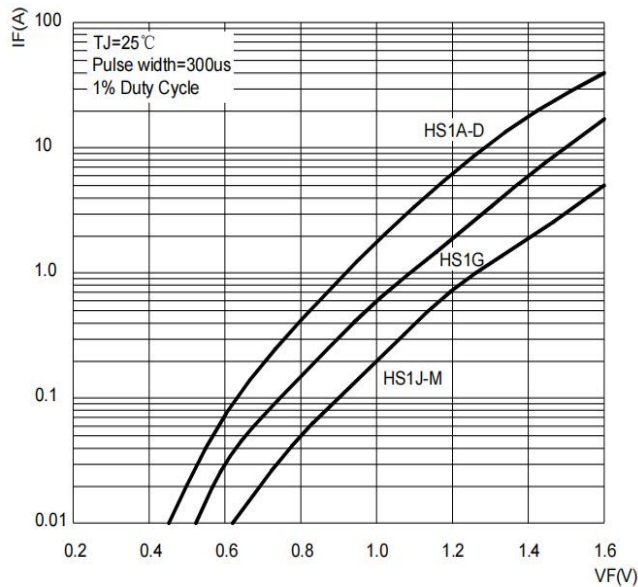

**FIG4: Typical Reverse Characteristics**

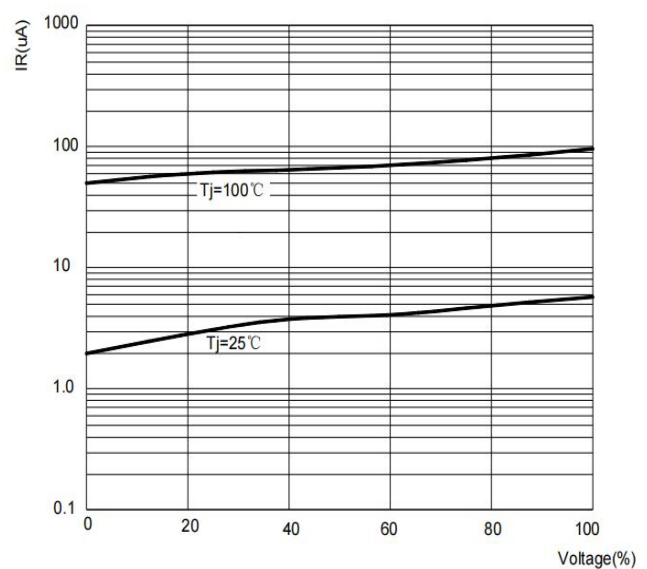

**FIG5: Diagram of circuit and Testing wave form of reverse recovery time**

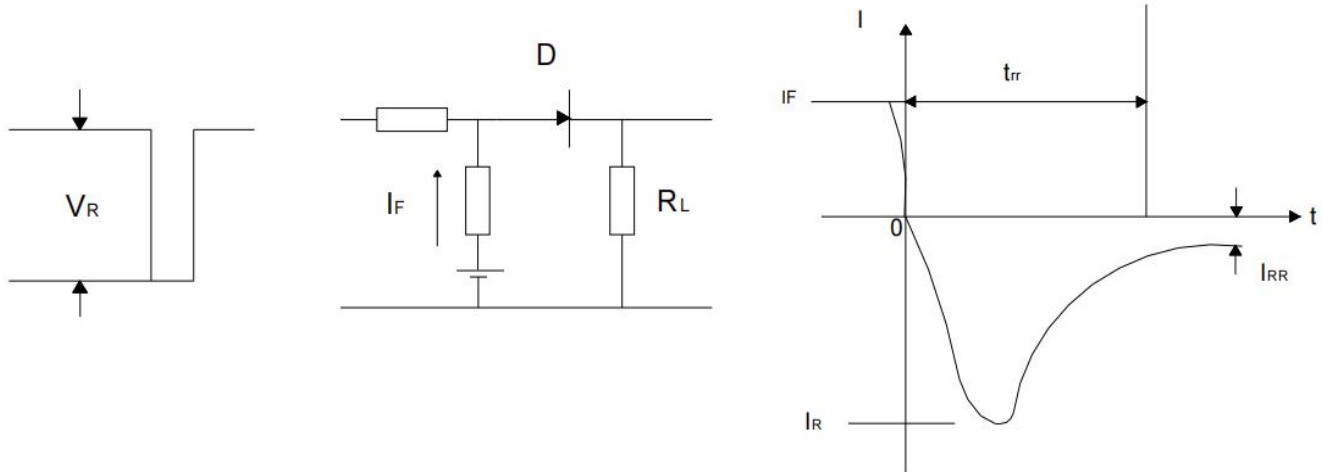

# HS1A THRU HS1M

## Ordering Information (Example)

PREFERED	PACKAGE CODE	MINIMUM PACKAGE(pcs)	INNER BOX QUANTITY(pcs)	OUTER CARTON QUANTITY(pcs)	DELIVERY MODE
HS1A ~ HS1M	DO-214AC(SMA)	5000	10000	80000	13" reel
HS1A ~ HS1M	DO-214AC(SMA)	7500	15000	120000	13" reel

## Outline Dimensions

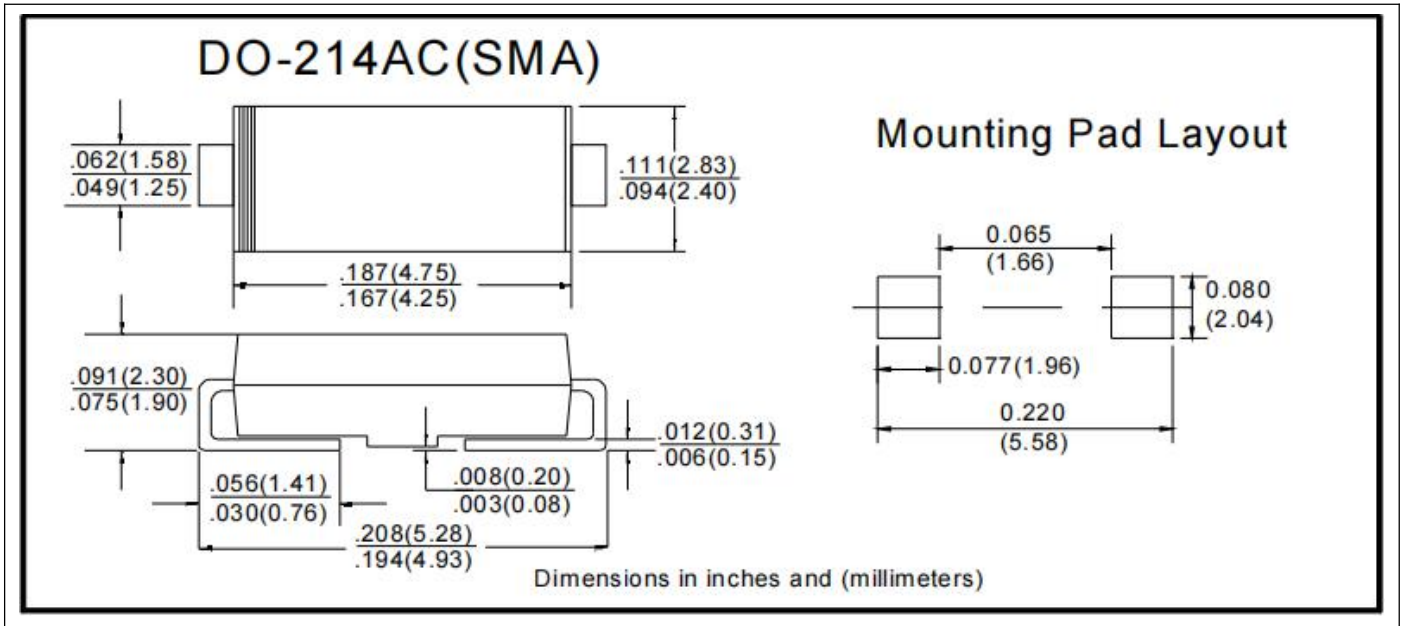

## X-ON Electronics

Largest Supplier of Electrical and Electronic Components

*Click to view similar products for [Rectifiers](#) category:*

*Click to view products by [Ruilongyuan](#) manufacturer:*

Other Similar products are found below :

[70HFR40](#) [FR105 R0](#) [RL252-TP](#) [1N5397](#) [1N4005-TR](#) [1N4007-BP](#) [UFS120Je3/TR13](#) [20ETS12S](#) [RRE02VS6SGTR](#) [MS306](#) [A1N5404G-G](#)  
[CRF02\(T5L,TEMQ\)](#) [ACGRB207-HF](#) [CLH07\(TE16L,Q\)](#) [CLH03\(TE16L,Q\)](#) [1N5395-TP](#) [UES1302](#) [ACGRC307-HF](#) [ACEFC304-HF](#) [DZ-](#)  
[1380](#) [85HFR60](#) [40HFR60](#) [70HF120](#) [85HFR80](#) [SCF7500](#) [SM100](#) [ACGRA4001-HF](#) [SKN70/08](#) [NTE5819](#) [NTE5827](#) [NTE5828](#) [NTE5911](#)  
[NTE5915](#) [NTE6104](#) [NTE6163](#) [NTE6164](#) [NTE6165](#) [NTE6364](#) [TSD3G](#) [SET130312](#) [NRVUS110VT3G](#) [UES1106](#) [UES1306](#)  
[NRVUS240VT3G](#) [D5FE60-5063](#) [R4000GPS-TP](#) [D4015L56TP](#) [UES1306HR2](#) [FX20K120](#) [D20XB60-7101](#)