

HS3AB THRU HS3MB (US3AB THRU US3MB)

High Efficient Rectifier

Features

- Low profile package
- Ideal for automated placement
- Glass passivated chip junction
- Ultra-fast reverse recovery time
- High forward surge capability
- Meets MSL level 1, per J-STD-020,LF maximum peak of 260 °C



Typical Application

For use in high frequency rectification of power supply, inverters, converters, and freewheeling diodes for consumer and telecommunication.

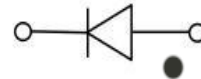

Mechanical Data

- Package: DO-214AA(SMB)
Molding compound meets UL 94 V-0 flammability rating,RoHS-compliant
- Terminals: Tin plated leads, solderable per J-STD-002 and JESD22-B102
- Polarity: Cathode line denotes the cathode end

Maximum Ratings (Ta=25°C Unless otherwise specified)

PARAMETER	Symbol	Unit	Conditions	HS3/US3							
				AB	BB	DB	FB	GB	JB	KB	MB
Repetitive Peak Reverse Voltage	V_{RRM}	V		50	100	200	300	400	600	800	1000
Average Forward Current	$I_{F(AV)}$	A	60HZ Half-sine wave,Resistance load, TL=110°C	3							
Surge(Nonrepetitive)Forward Current	I_{FSM}	A	60HZ Half-sine wave, 1 cycle, Ta=25°C	100							
Storage Temperature	T_{stg}	°C		-55 ~ +150							
Junction Temperature	T_j	°C		-55 ~ +150							

Electrical Characteristics (Ta=25°C Unless otherwise specified)

PARAMETER	Symbol	Unit	Conditions	HS3/US3					
				AB	BB	DB	FB	GB	JB
Peak Forward Voltage	V_{FM}	V	$I_{FM} = 3.0A$	1.0		1.3		1.7	
Peak Reverse Current	I_{RRM1}	μA	$V_{RM} = V_{RRM}$	Ta=25°C		10			
	I_{RRM2}			Ta=100°C		200			
Maximum reverse recovery time	T_{rr}	ns	$I_F = 0.5A, I_R = 1.0A, I_{rr} = 0.25A$	50				75	
Thermal Resistance(Typical)	$R_{\theta J-A}$	°C/W	Between junction and ambient	47 ¹⁾					
	$R_{\theta J-L}$		Between junction and terminal	13 ¹⁾					

Notes:

1) Thermal resistance from junction to ambient and from junction to lead mounted on P.C.B. with 0.2" x 0.2" (5.0 mm x 5.0 mm) copper pad areas.



HS3AB THRU HS3MB (US3AB THRU US3MB)

■ Characteristics (Typical)

FIG1: Forward Current Derating Curve

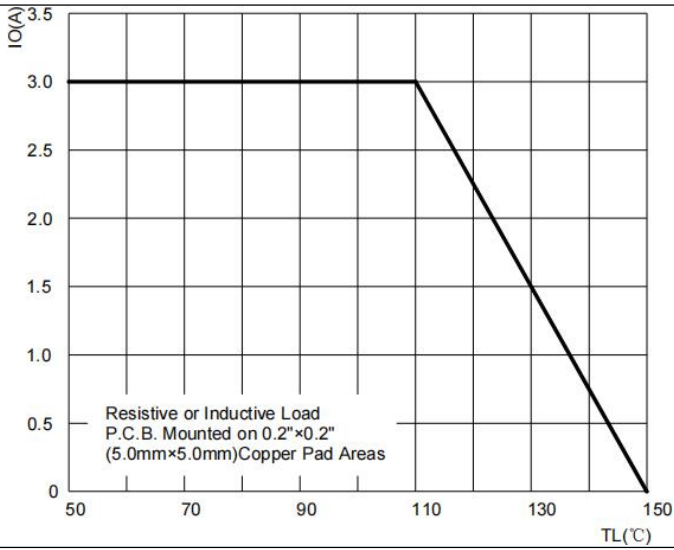

FIG2: Surge Forward Current Capability

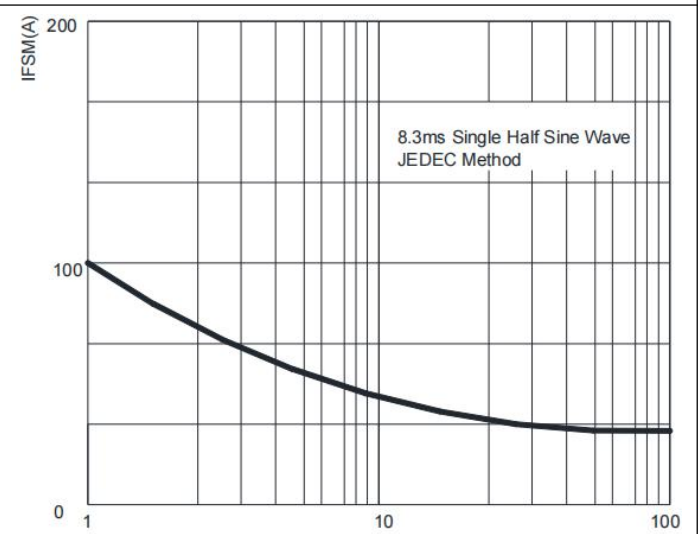

FIG3: Instantaneous Forward Voltage

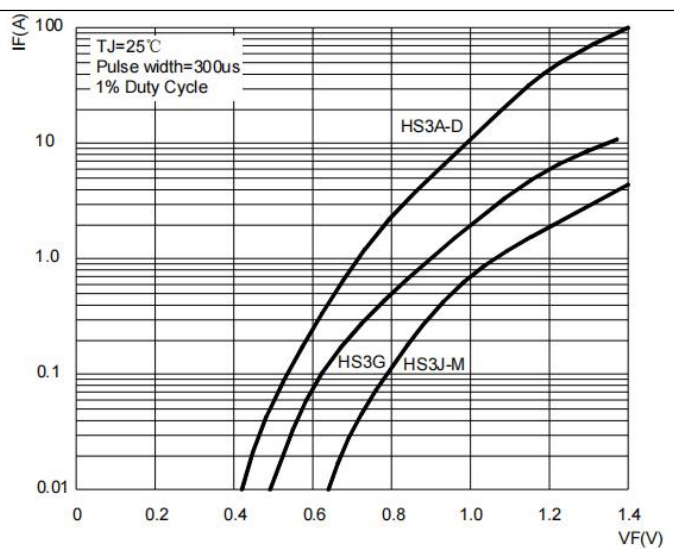

FIG4: Typical Reverse Characteristics

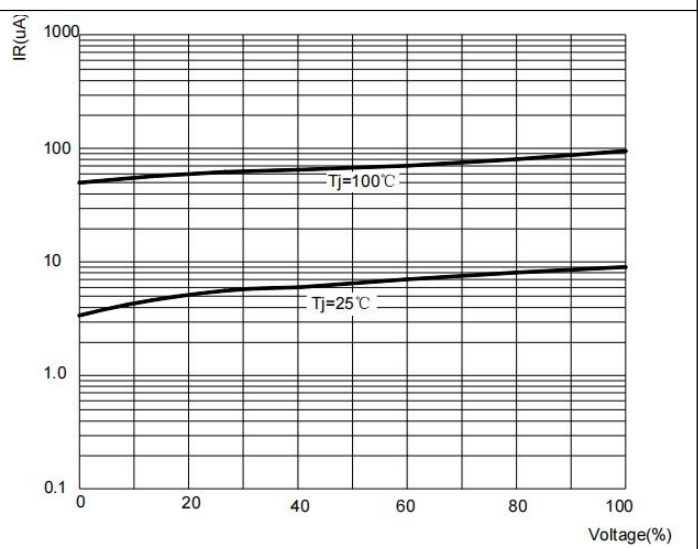
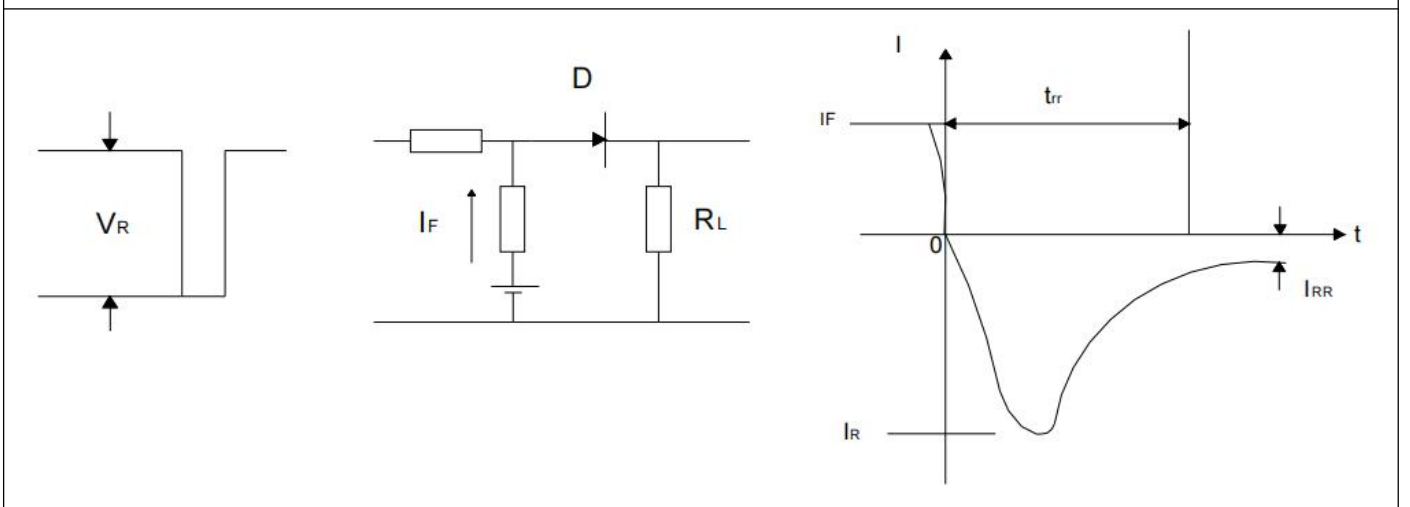

FIG5: Diagram of circuit and Testing wave form of reverse recovery time



HS3AB THRU HS3MB (US3AB THRU US3MB)

■ Ordering Information (Example)

PREFERRED	PACKAGE CODE	MINIMUM PACKAGE(pcs)	INNER BOX QUANTITY(pcs)	OUTER CARTON QUANTITY(pcs)	DELIVERY MODE
HS3AB THRU HS3MB (US3AB THRU US3MB)	DO-214AA(SMB)	3000	6000	48000	13" reel

■ Outline Dimensions

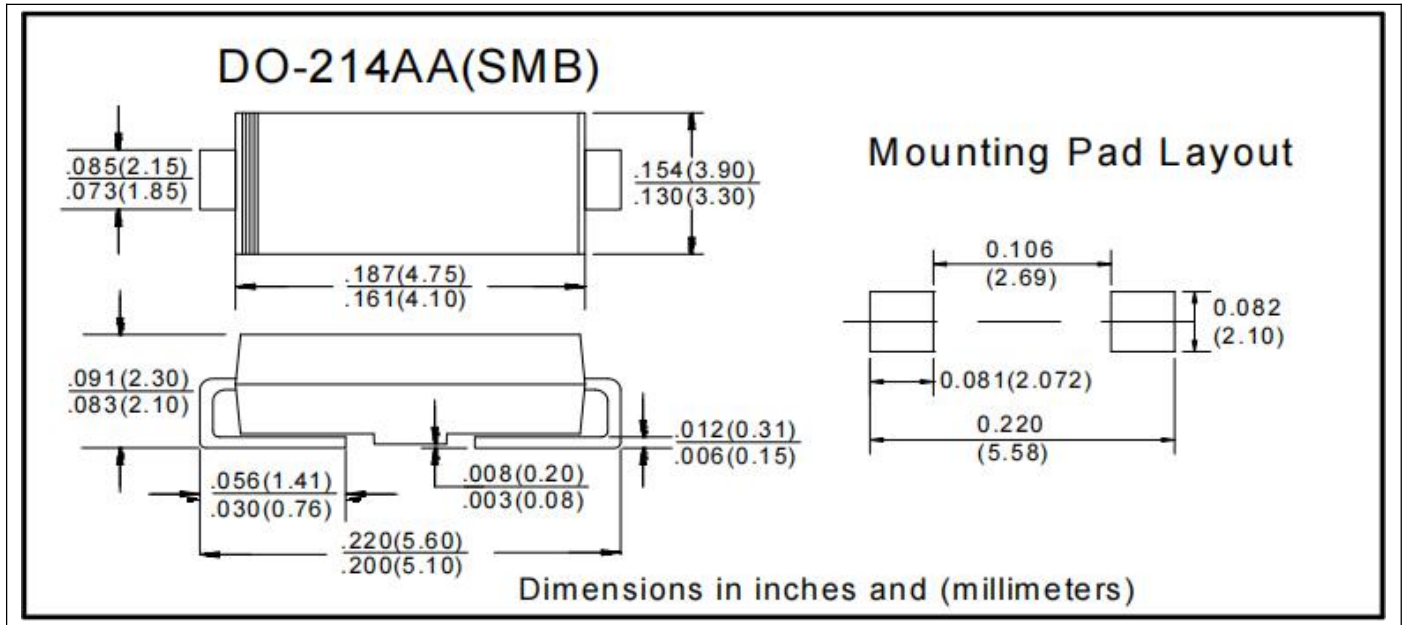

X-ON Electronics

Largest Supplier of Electrical and Electronic Components

Click to view similar products for [Rectifiers](#) category:

Click to view products by [Ruilongyuan](#) manufacturer:

Other Similar products are found below :

[70HFR40](#) [FR105 R0](#) [RL252-TP](#) [1N5397](#) [1N4005-TR](#) [1N4007-BP](#) [UFS120Je3/TR13](#) [20ETS12S](#) [RRE02VS6SGTR](#) [MS306](#) [A1N5404G-G](#)
[CRF02\(T5L,TEMQ\)](#) [ACGRB207-HF](#) [CLH07\(TE16L,Q\)](#) [CLH03\(TE16L,Q\)](#) [1N5395-TP](#) [UES1302](#) [ACGRC307-HF](#) [ACEFC304-HF](#) [DZ-](#)
[1380](#) [85HFR60](#) [40HFR60](#) [70HF120](#) [85HFR80](#) [SCF7500](#) [SM100](#) [ACGRA4001-HF](#) [SKN70/08](#) [NTE5819](#) [NTE5827](#) [NTE5828](#) [NTE5911](#)
[NTE5915](#) [NTE6104](#) [NTE6163](#) [NTE6164](#) [NTE6165](#) [NTE6364](#) [TSD3G](#) [SET130312](#) [NRVUS110VT3G](#) [UES1106](#) [UES1306](#)
[NRVUS240VT3G](#) [D5FE60-5063](#) [R4000GPS-TP](#) [D4015L56TP](#) [UES1306HR2](#) [FX20K120](#) [D20XB60-7101](#)