

HS3A THRU HS3M

High Efficient Rectifier

Features

- Low profile package
- Ideal for automated placement
- Glass passivated chip junction
- Ultra-fast reverse recovery time
- High forward surge capability
- Meets MSL level 1, per J-STD-020,LF maximum peak of 260 °C



Typical Application

For use in high frequency rectification of power supply, inverters, converters, and freewheeling diodes for consumer and telecommunication.

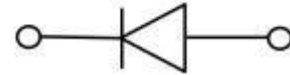

Mechanical Data

- Package: DO-214AB(SMC)
Molding compound meets UL 94 V-0 flammability rating,RoHS-compliant
- Terminals: Tin plated leads, solderable per J-STD-002 and JESD22-B102
- Polarity: Cathode line denotes the cathode end

Maximum Ratings (Ta=25°C Unless otherwise specified)

PARAMETER	Symbol	Unit	Conditions	HS3							
				A	B	D	F	G	J	K	M
Repetitive Peak Reverse Voltage	V _{RRM}	V		50	100	200	300	400	600	800	1000
Average Forward Current	I _{F(AV)}	A	60HZ Half-sin wave,Resistance load, TL=110°C	3							
Surge(Nonrepetitive)Forward Current	I _{FSM}	A	60HZ Half-sine wave, 1 cycle, Ta=25°C	100							
Storage Temperature	T _{stg}	°C		-55 ~ +150							
Junction Temperature	T _j	°C		-55 ~ +150							

Electrical Characteristics (Ta=25°C Unless otherwise specified)

PARAMETER	Symbol	Unit	Conditions	HS3						
				A	B	D	F	G	J	K
Peak Forward Voltage	V _{FM}	V	IFM =3.0A	1.0		1.3		1.7		
Peak Reverse Current	I _{RRM1}	µA	VRM=VRRM	10						
	I _{RRM2}			200						
Maximum reverse recovery time	T _{rr}	ns	I _F =0.5A,I _R =1.0A,I _{rr} =0.25A	50				75		
Thermal Resistance(Typical)	R _{θJ-A}	°C/W	Between junction and ambient	47 ¹⁾						
	R _{θJ-L}		Between junction and terminal	13 ¹⁾						

Notes:

1) Thermal resistance from junction to ambient and from junction to lead mounted on P.C.B. with 0.2" x 0.2" (5.0 mm x 5.0 mm) copper pad areas.



HS3A THRU HS3M

■ Characteristics (Typical)

FIG1: Forward Current Derating Curve

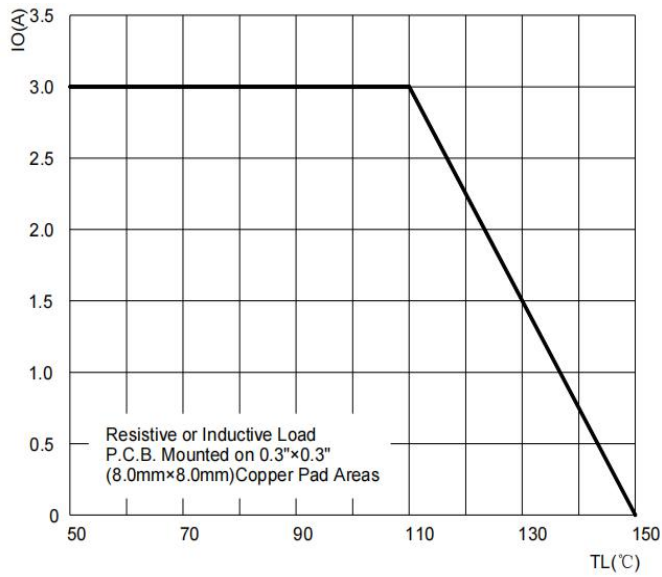

FIG2: Surge Forward Current Capability

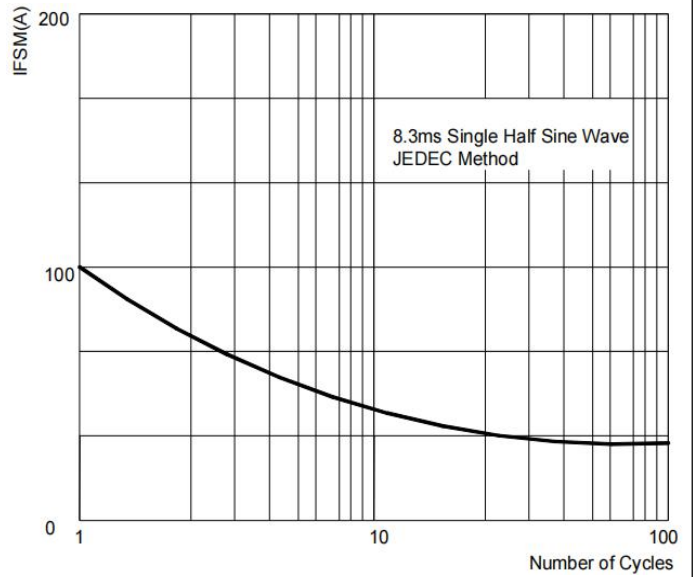

FIG3: Instantaneous Forward Voltage

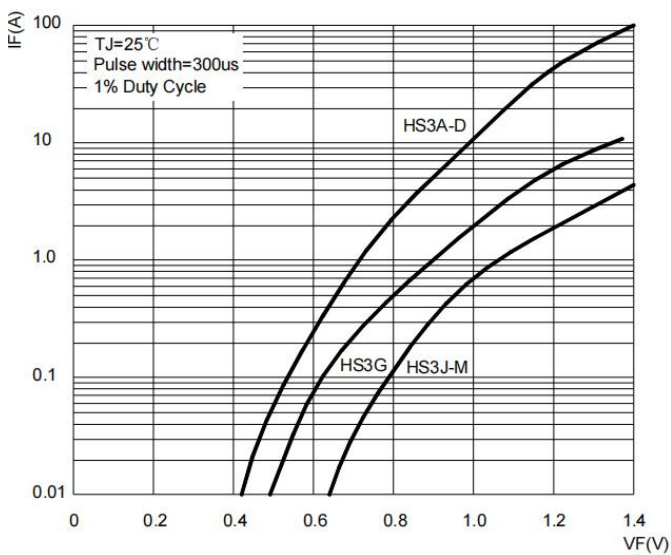

FIG4: Typical Reverse Characteristics

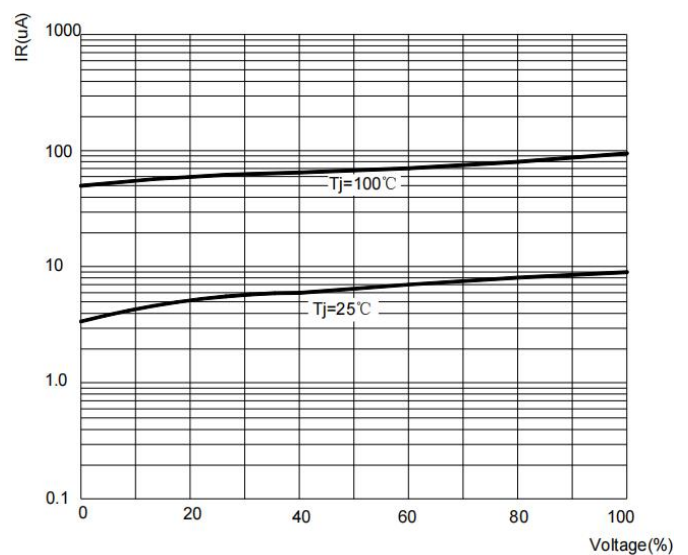
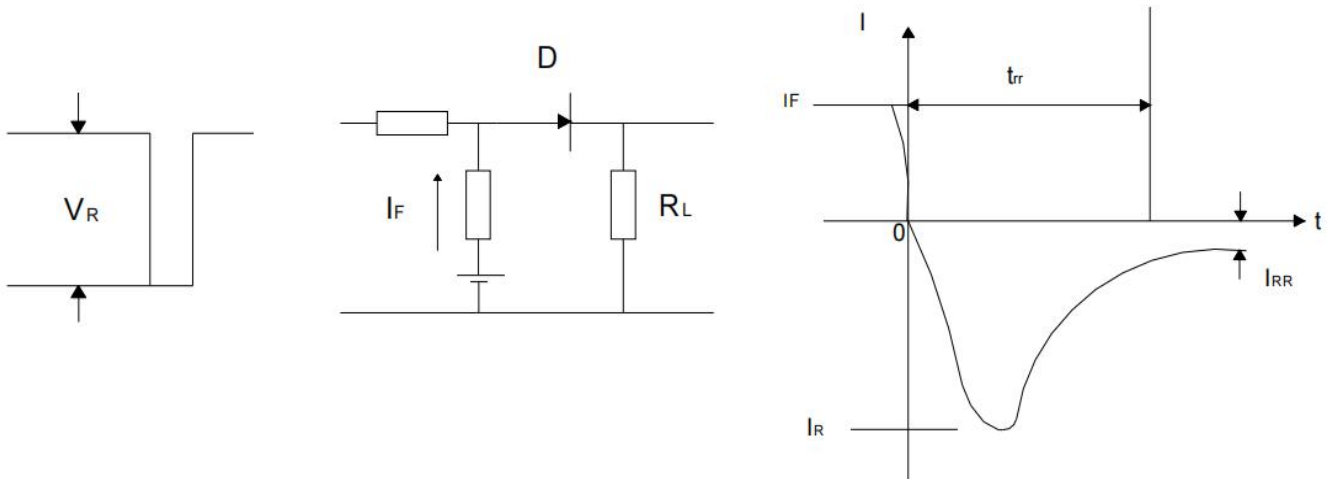

FIG5: Diagram of circuit and Testing wave form of reverse recovery time



HS3A THRU HS3M

Ordering Information (Example)

PREFERED	PACKAGE CODE	MINIMUM PACKAGE(pcs)	INNER BOX QUANTITY(pcs)	OUTER CARTON QUANTITY(pcs)	DELIVERY MODE
HS3A~ HS3M	DO-214AB(SMC)	3000	6000	42000	13" reel

Outline Dimensions

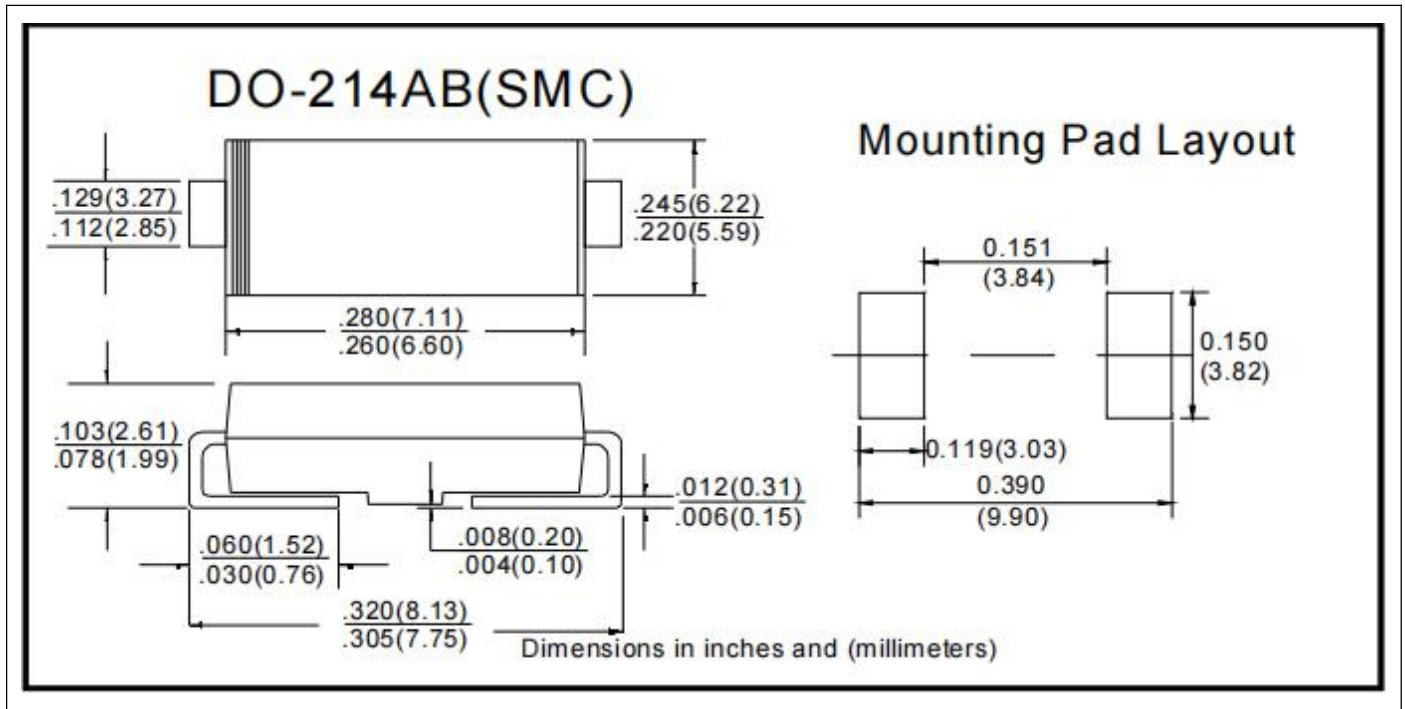

X-ON Electronics

Largest Supplier of Electrical and Electronic Components

Click to view similar products for [Rectifiers](#) category:

Click to view products by [Ruilongyuan](#) manufacturer:

Other Similar products are found below :

[70HFR40](#) [FR105 R0](#) [RL252-TP](#) [1N5397](#) [JANTX1N5634A](#) [1N4002G](#) [1N4005-TR](#) [JANS1N6640US](#) [481235F](#) [RRE02VS6SGTR](#) [067907F](#)
[MS306](#) [US2JFL-TP](#) [A1N5404G-G](#) [CRS12\(T5L,TEMQ\)](#) [ACGRB207-HF](#) [CLH07\(TE16L,Q\)](#) [CLH03\(TE16L,Q\)](#) [ACGRC307-HF](#)
[ACEFC304-HF](#) [DZ-1380](#) [NTE6356](#) [NTE6359](#) [JAN1N5555](#) [85HFR60](#) [40HFR60](#) [70HF120](#) [85HFR80](#) [D126A45C](#) [SCF7500](#) [SCHJ22.5K](#)
[SM100](#) [SCPA2](#) [SDHD5K](#) [ACGRA4001-HF](#) [D1821SH45T PR](#) [D1251S45T](#) [NTE6358](#) [NTE5850](#) [NTE5819](#) [NTE5837](#) [NTE5892](#) [NTE5900](#)
[NTE5911](#) [NTE5915](#) [NTE5921](#) [NTE6104](#) [NTE6105](#) [NTE6154](#) [NTE6158](#)