

HS5A THRU HS5M

High Efficient Rectifier

Features

- Low profile package
- Ideal for automated placement
- Glass passivated chip junction
- Ultra-fast reverse recovery time
- High forward surge capability
- Meets MSL level 1, per J-STD-020,LF maximum peak of 260 °C



Typical Application

For use in high frequency rectification of power supply, inverters, converters, and freewheeling diodes for consumer and telecommunication.

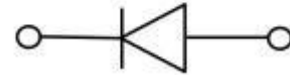

Mechanical Data

- Package: DO-214AB(SMC)
Molding compound meets UL 94 V-0 flammability rating,RoHS-compliant
- Terminals: Tin plated leads, solderable per J-STD-002 and JESD22-B102
- Polarity: Cathode line denotes the cathode end

■ Maximum Ratings (Ta=25°C Unless otherwise specified)

PARAMETER	Symbol	Unit	Conditions	HS5							
				A	B	D	F	G	J	K	M
Repetitive Peak Reverse Voltage	V_{RRM}	V		50	100	200	300	400	600	800	1000
Average Forward Current	$I_{F(AV)}$	A	60HZ Half-sine wave,Resistance load, TL=110°C	5							
Surge(Nonrepetitive)Forward Current	I_{FSM}	A	60HZ Half-sine wave, 1 cycle, Ta=25°C	150							
Storage Temperature	T_{stg}	°C		-55 ~ +150							
Junction Temperature	T_j	°C		-55 ~ +150							

■ Electrical Characteristics (Ta=25°C Unless otherwise specified)

PARAMETER	Symbol	Unit	Conditions	HS5						
				A	B	D	F	G	J	K
Peak Forward Voltage	V_{FM}	V	$I_{FM} = 5.0A$	1.0		1.3		1.7		
Peak Reverse Current	I_{RRM1}	μA	$V_{RM} = V_{RRM}$	10						
	I_{RRM2}			250						
Maximum reverse recovery time	T_{rr}	ns	$I_F = 0.5A, I_R = 1.0A, I_{rr} = 0.25A$	50				75		
Thermal Resistance(Typical)	$R_{\theta J-A}$	°C/W	Between junction and ambient	47 ¹⁾						
	$R_{\theta J-L}$		Between junction and terminal	13 ¹⁾						

Notes:

1) Thermal resistance from junction to ambient and from junction to lead mounted on P.C.B. with 0.2" x 0.2" (5.0 mm x 5.0 mm) copper pad areas.



HS5A THRU HS5M

■ Characteristics (Typical)

FIG1: Forward Current Derating Curve

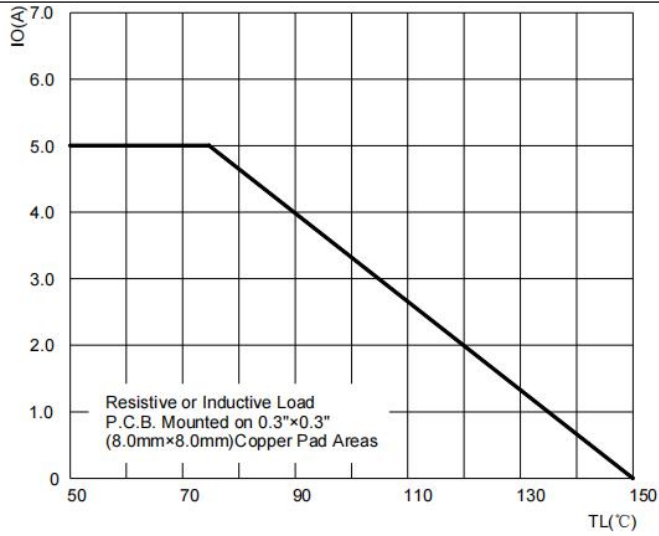

FIG2: Surge Forward Current Capability

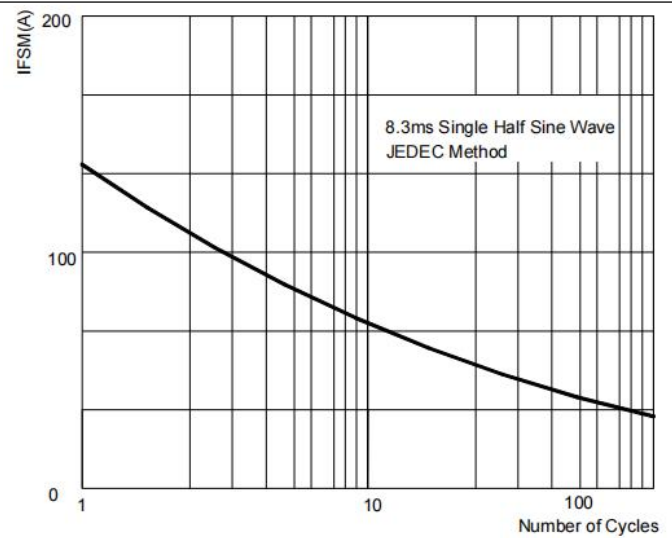

FIG3: Instantaneous Forward Voltage

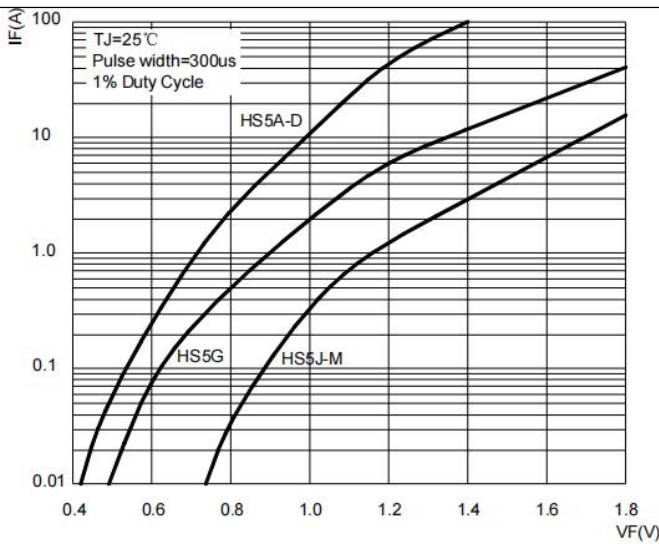

FIG4: Typical Reverse Characteristics

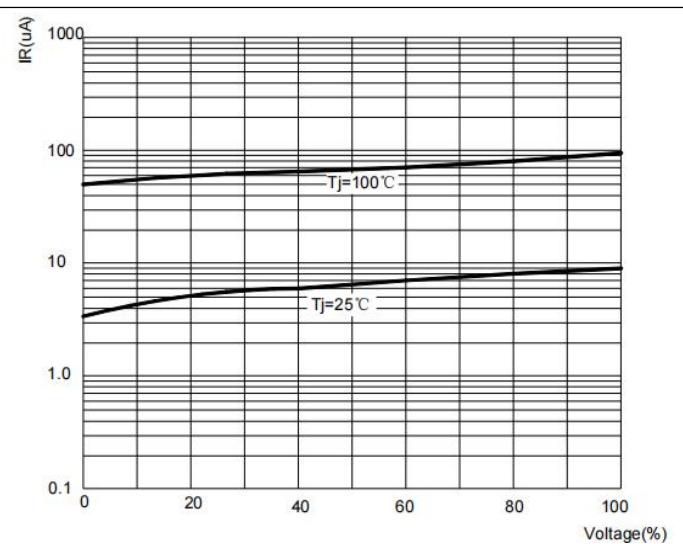
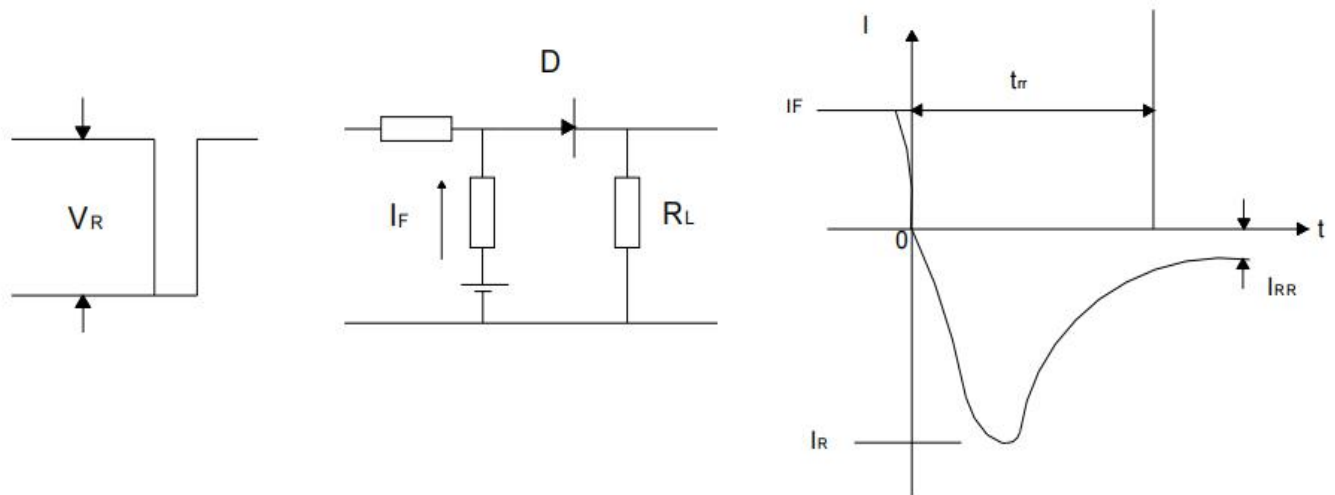

FIG5: Diagram of circuit and Testing wave form of reverse recovery time



HS5A THRU HS5M

Ordering Information (Example)

PREFERED	PACKAGE CODE	MINIMUM PACKAGE(pcs)	INNER BOX QUANTITY(pcs)	OUTER CARTON QUANTITY(pcs)	DELIVERY MODE
HS5A THRU HS5M	DO-214AB(SMC)	3000	6000	42000	13" reel

Outline Dimensions

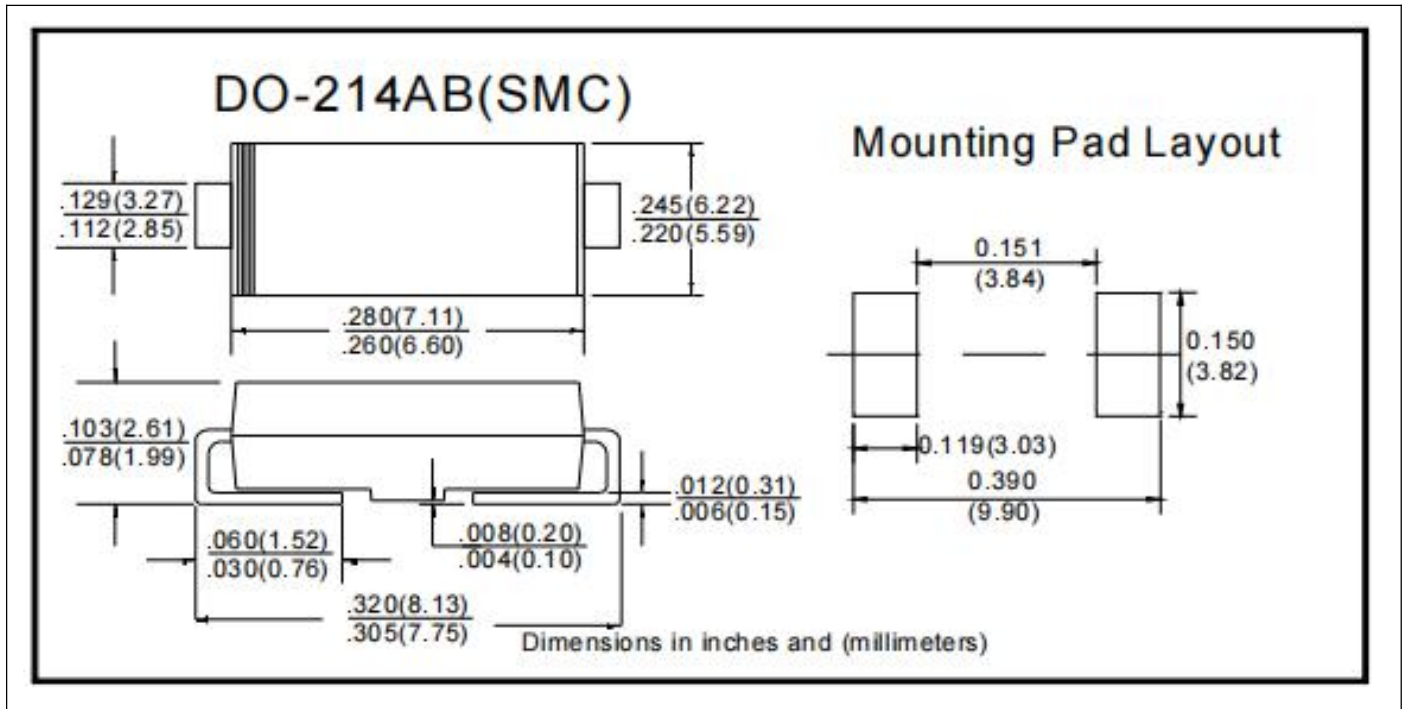

X-ON Electronics

Largest Supplier of Electrical and Electronic Components

Click to view similar products for [Rectifiers](#) category:

Click to view products by [Ruilongyuan](#) manufacturer:

Other Similar products are found below :

[70HFR40](#) [FR105 R0](#) [RL252-TP](#) [1N5397](#) [1N4005-TR](#) [1N4007-BP](#) [UFS120Je3/TR13](#) [20ETS12S](#) [RRE02VS6SGTR](#) [MS306](#) [A1N5404G-G](#)
[CRF02\(T5L,TEMQ\)](#) [ACGRB207-HF](#) [CLH07\(TE16L,Q\)](#) [CLH03\(TE16L,Q\)](#) [1N5395-TP](#) [UES1302](#) [ACGRC307-HF](#) [ACEFC304-HF](#) [DZ-](#)
[1380](#) [85HFR60](#) [40HFR60](#) [70HF120](#) [85HFR80](#) [SCF7500](#) [SM100](#) [ACGRA4001-HF](#) [SKN70/08](#) [NTE5819](#) [NTE5827](#) [NTE5828](#) [NTE5911](#)
[NTE5915](#) [NTE6104](#) [NTE6163](#) [NTE6164](#) [NTE6165](#) [NTE6364](#) [TSD3G](#) [SET130312](#) [NRVUS110VT3G](#) [UES1106](#) [UES1306](#)
[NRVUS240VT3G](#) [D5FE60-5063](#) [R4000GPS-TP](#) [D4015L56TP](#) [UES1306HR2](#) [FX20K120](#) [D20XB60-7101](#)