

MUR2010FCT THRU MUR2060FCT

Ultra-Fast Recovery Rectifier Diodes

Features

- Ultra-fast recovery time for high efficiency
- Glass passivated chip junction
- Low leakage current
- High forward surge capability
- Solder dip maximum peak of 275 °C /7s, per JESD 22-B106

Typical Application

For use in high frequency rectification and freewheeling application in switching mode converters and inverters for consumer ,computer and telecommunication.

Mechanical Data

- Package: ITO-220AB
Molding compound meets UL 94 V-0 flammability rating, RoHS-compliant
- Terminals: Tin plated leads, solderable per J-STD-002 and JESD22-B102
- Polarity: Color Band denotes cathode end

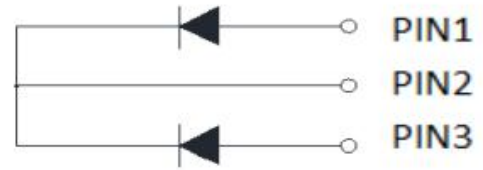

Maximum Ratings (Ta=25°C Unless otherwise specified)

PARAMETER	Symbol	Unit	Conditions	MUR-FCT				
				2010	2015	2020	2040	2060
Repetitive Peak Reverse Voltage	V_{RRM}	V		100	150	200	400	600
Average Forward Current	I_O	A	60HZ Half-sine wave, Resistance load, Tc(Fig.1)	20				
Surge(Nonrepetitive)Forward Current	I_{FSM}	A	60HZ sine wave, 1 cycle, Ta=25°C	125				
Current Squared Time	$I^2 t$	A ² s	1ms≤t<8.3ms Tj=25°C, Rating of per diode	65				
Storage Temperature	T_{stg}	°C		-55 ~ +150				
Junction Temperature	T_j	°C		-55 ~ +150				

Electrical Characteristics (Ta=25°C Unless otherwise specified)

PARAMETER	Symbol	Unit	Conditions	MUR-FCT				
				2010	2015	2020	2040	2060
Peak Forward Voltage	VFM	V	$I_{FM}=10.0A$	0.975			1.35	1.7
Peak Reverse Current	I_{RRM1}	μA	$V_{RM}=V_{RRM}$	Ta=25°C				
	I_{RRM2}			Ta=125°C				
Maximum reverse recovery time	T_{rr}	ns	$I_F=0.5A, I_R=1.0A, I_{rr}=0.25A$	35				
Thermal Resistance	$R_{θJ-C}$	$R_{θJ-C}$	Between junction and case	2.0				



MUR2010FCT THRU MUR2060FCT

■ Characteristics (Typical)

FIG1: Forward Current Derating Curve

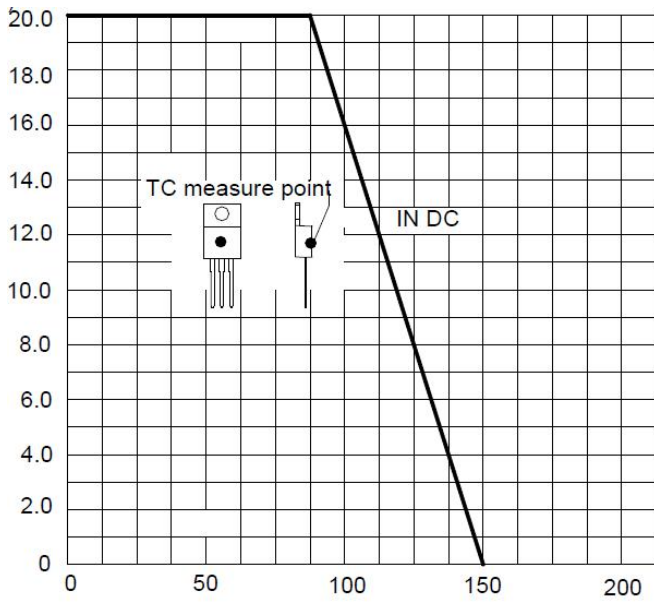

FIG2: Surge Forward Current Capability

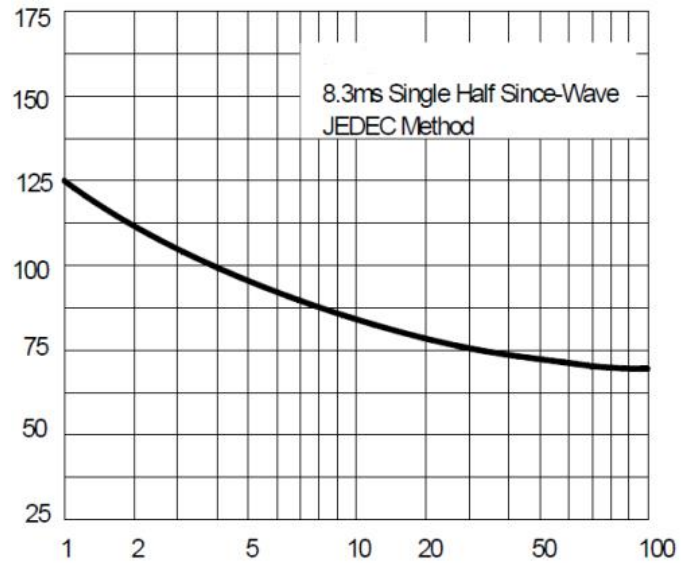

FIG3: Instantaneous Forward Voltage

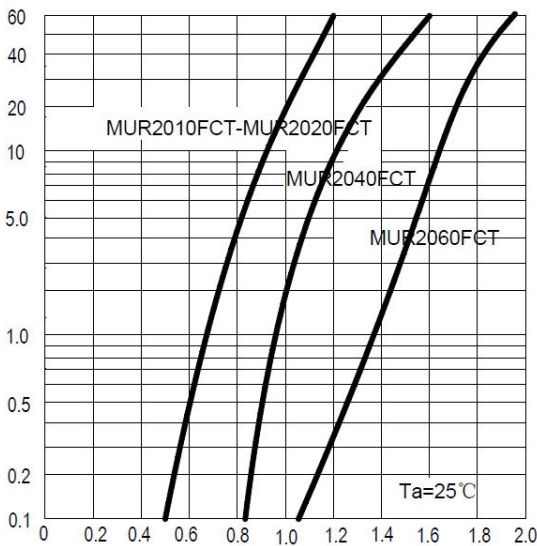

FIG4: Typical Reverse Characteristics

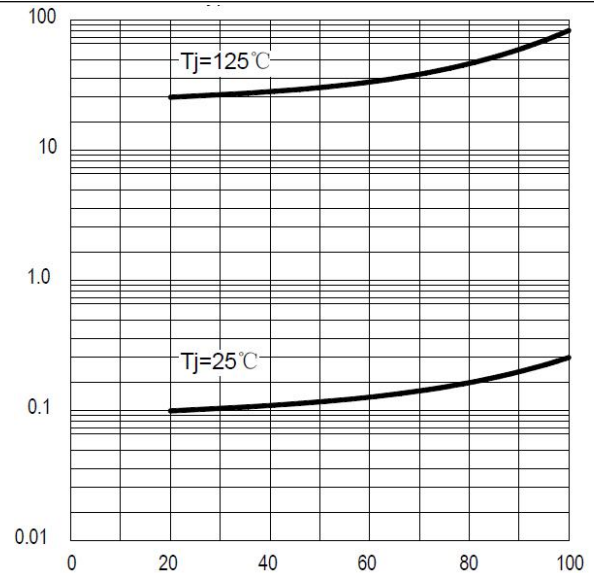
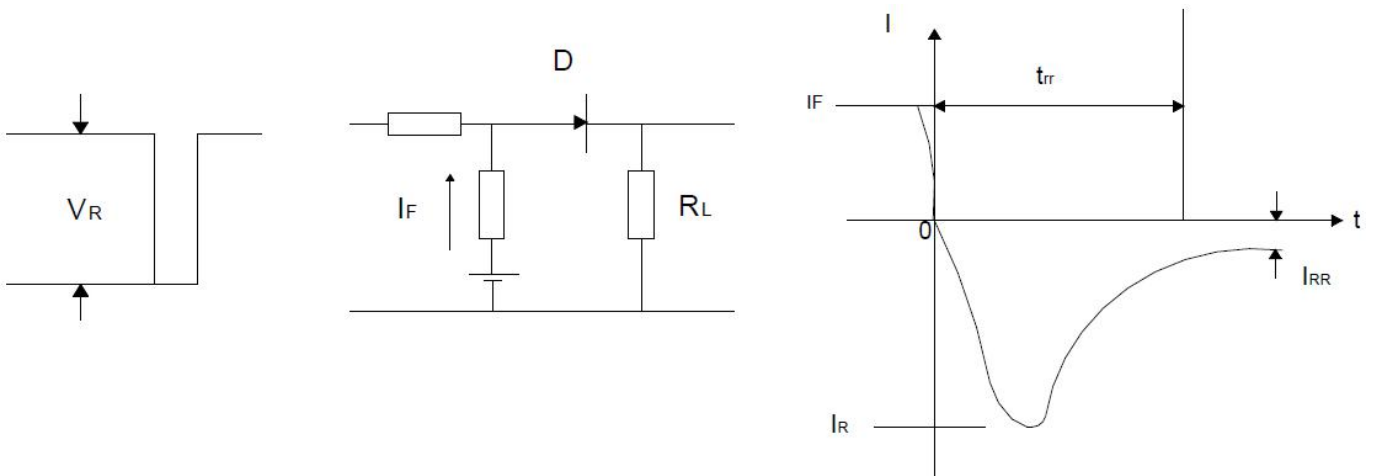

FIG5: Diagram of circuit and Testing wave form of reverse recovery time



MUR2010FCT THRU MUR2060FCT

Ordering Information (Example)

PREFERED	PACKAGE CODE	MINIMUM PACKAGE(pcs)	INNER BOX QUANTITY(pcs)	OUTER CARTON QUANTITY(pcs)	DELIVERY MODE
MUR2010FCT~MUR2060FCT	ITO-220AB	50	1000	5000	Tube

Outline Dimensions

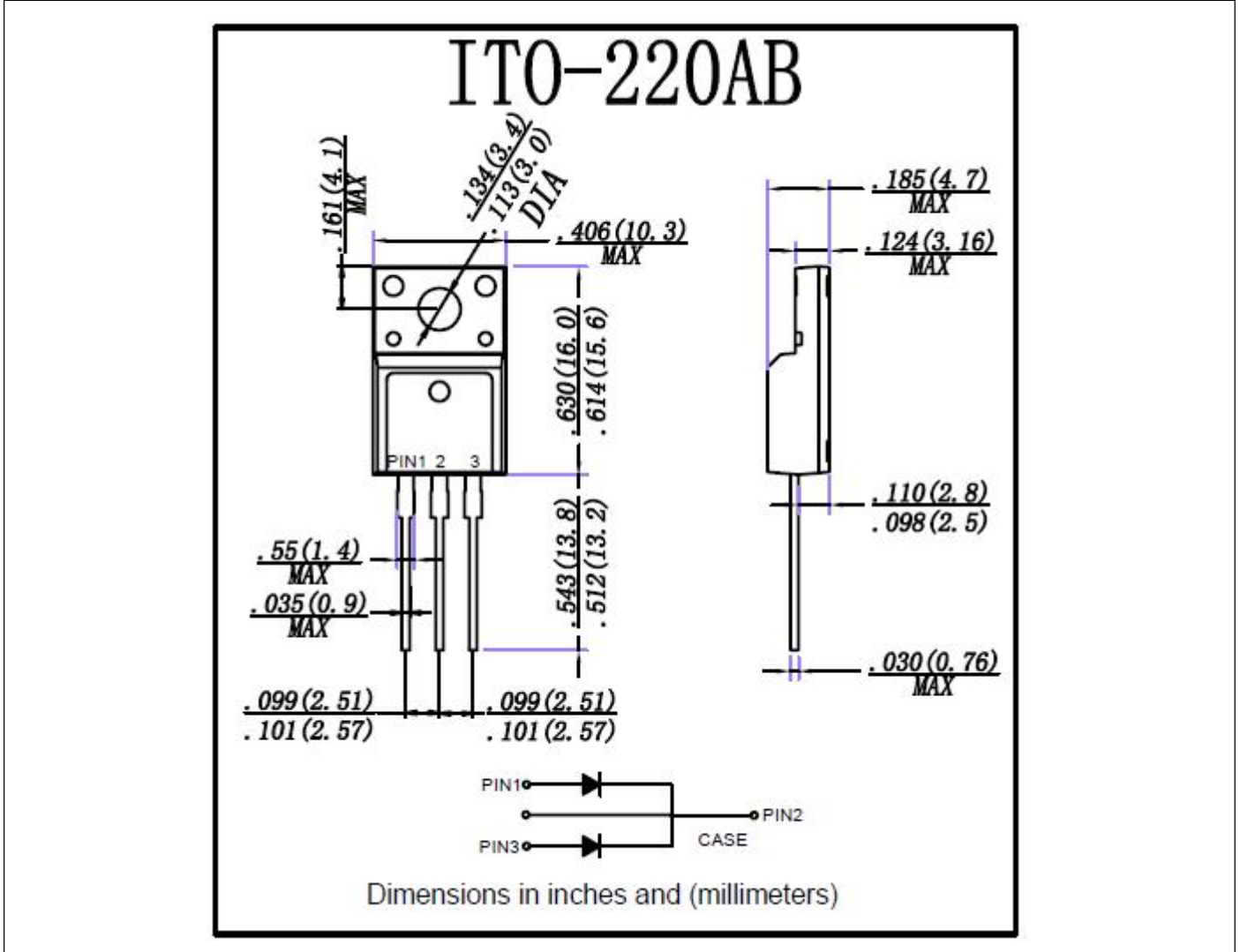

X-ON Electronics

Largest Supplier of Electrical and Electronic Components

Click to view similar products for [Rectifiers](#) category:

Click to view products by [Ruilongyuan](#) manufacturer:

Other Similar products are found below :

[70HFR40](#) [FR105 R0](#) [RL252-TP](#) [1N5397](#) [1N4005-TR](#) [1N4007-BP](#) [UFS120Je3/TR13](#) [20ETS12S](#) [RRE02VS6SGTR](#) [MS306](#) [A1N5404G-G](#)
[CRF02\(T5L,TEMQ\)](#) [ACGRB207-HF](#) [CLH07\(TE16L,Q\)](#) [CLH03\(TE16L,Q\)](#) [1N5395-TP](#) [UES1302](#) [ACGRC307-HF](#) [ACEFC304-HF](#) [DZ-](#)
[1380](#) [85HFR60](#) [40HFR60](#) [70HF120](#) [85HFR80](#) [SCF7500](#) [SM100](#) [ACGRA4001-HF](#) [SKN70/08](#) [NTE5819](#) [NTE5827](#) [NTE5828](#) [NTE5911](#)
[NTE5915](#) [NTE6104](#) [NTE6163](#) [NTE6164](#) [NTE6165](#) [NTE6364](#) [TSD3G](#) [SET130312](#) [NRVUS110VT3G](#) [UES1106](#) [UES1306](#)
[NRVUS240VT3G](#) [D5FE60-5063](#) [R4000GPS-TP](#) [D4015L56TP](#) [UES1306HR2](#) [FX20K120](#) [D20XB60-7101](#)