

MUR810F THRU MUR860F

Ultra-Fast Recovery Rectifier Diodes

Features

- Ultra-fast recovery time for high efficiency
- Glass passivated chip junction
- Low leakage current
- High forward surge capability
- Solder dip maximum peak of 275 °C /7s, per JESD 22-B106

Typical Application

For use in super-fast switching rectification and freewheeling application in switching mode converters and inverters for consumer ,computer and telecommunication.

Mechanical Data

- Package: ITO-220AC
Molding compound meets UL 94 V-0 flammability rating, RoHS-compliant
- Terminals: Tin plated leads, solderable per J-STD-002 and JESD22-B102
- Polarity: Color Band denotes cathode end

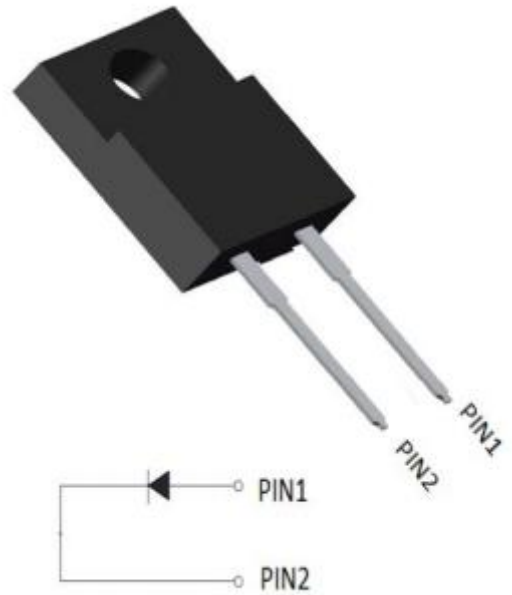

Maximum Ratings (Ta=25°C Unless otherwise specified)

PARAMETER	Symbol	Unit	Conditions	MUR				
				810F	815F	820F	840F	860F
Repetitive Peak Reverse Voltage	V_{RRM}	V		100	150	200	400	600
Average Rectified Output Current	I_o	A	60HZ Half-sine wave, Resistance load, TC(Fig.1)	8				
Surge(Nonrepetitive)Forward Current	I_{FSM}	A	60HZ sine wave, 1 cycle, Ta=25°C	125				
Current Squared Time	I^2t	A ² s	1ms ≤ t < 8.3ms Tj=25°C	65				
Storage Temperature	T_{stg}	°C		-55 ~ +150				
Junction Temperature	T_j	°C		-55 ~ +150				

Electrical Characteristics (Ta=25°C Unless otherwise specified)

PARAMETER	Symbol	Unit	Conditions	MUR				
				810F	815F	820F	840F	860F
Peak Forward Voltage	V_{FM}	V	$I_{FM} = 8.0A$	0.95			1.25	1.7
Peak Reverse Current	I_{RRM1}	μA	$V_{RM} = V_{RRM}$	Ta=25°C				
	I_{RRM2}			Ta=100°C				
Reverse Recovery Time	T_{rr}	ns	$I_F = 0.5A, I_R = 1.0A, I_{rr} = 0.25A$	35			50	
Thermal Resistance(Typical)	$R_{θj-c}$	°C/W	Between junction and ambient	2.0				



MUR810F THRU MUR860F

■ Characteristics (Typical)

FIG1: Forward Current Derating Curve

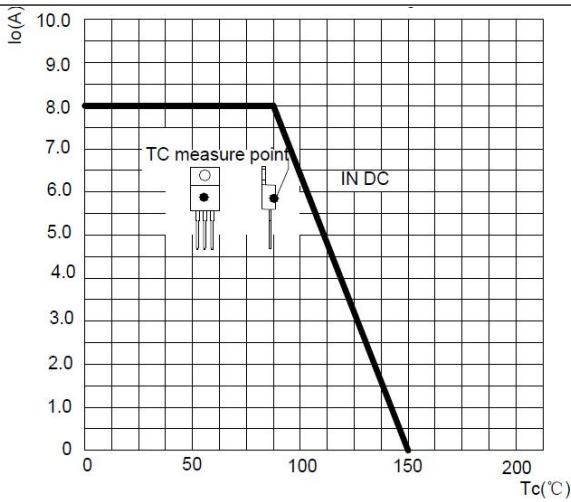

FIG2: Surge Forward Current Capability

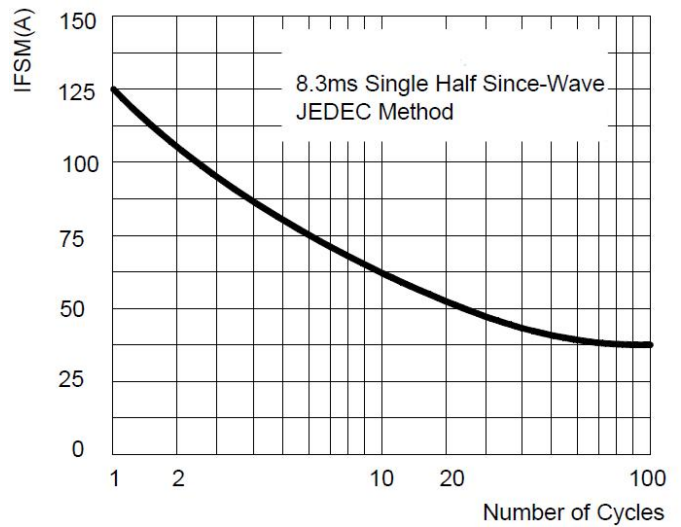

FIG3: Instantaneous Forward Voltage

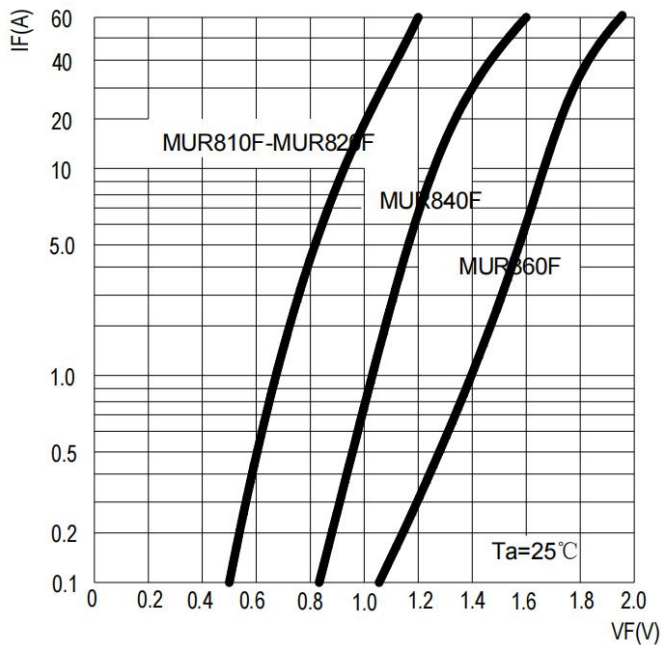

FIG4: Typical Reverse Characteristics

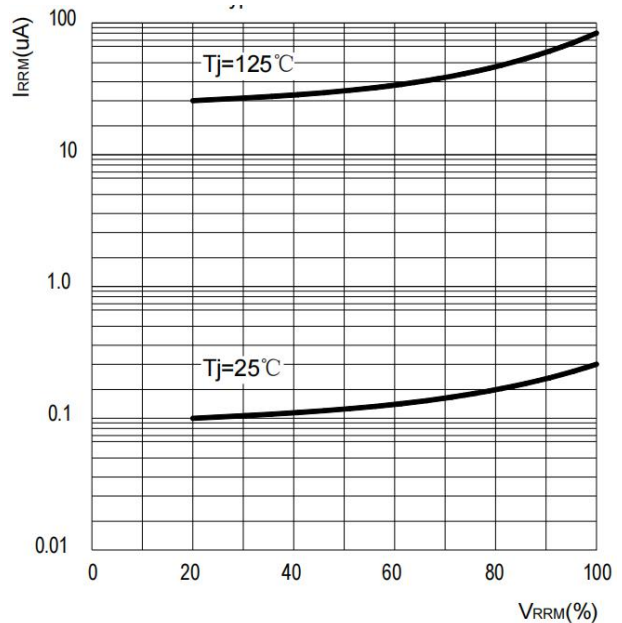
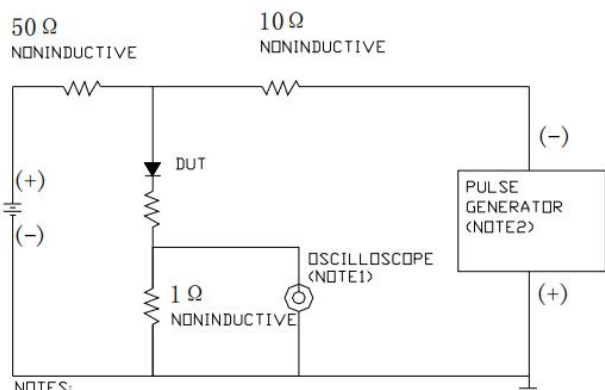
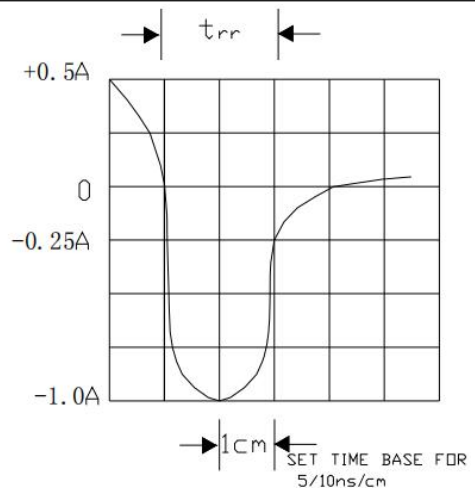

FIG5: Diagram of circuit and Testing wave form of reverse recovery time



NOTES:
 1. Rise Time = 7ns max. Input Impedance = 1MΩ ±2pf
 2. Rise Time = 10ns max. Source Impedance = 50Ω



MUR810F THRU MUR860F

Ordering Information (Example)

PREFERED	PACKAGE CODE	MINIMUM PACKAGE(pcs)	INNER BOX QUANTITY(pcs)	OUTER CARTON QUANTITY(pcs)	DELIVERY MODE
MUR810F THRU MUR860F	ITO-220AC	50	1000	5000	Tube

Outline Dimensions

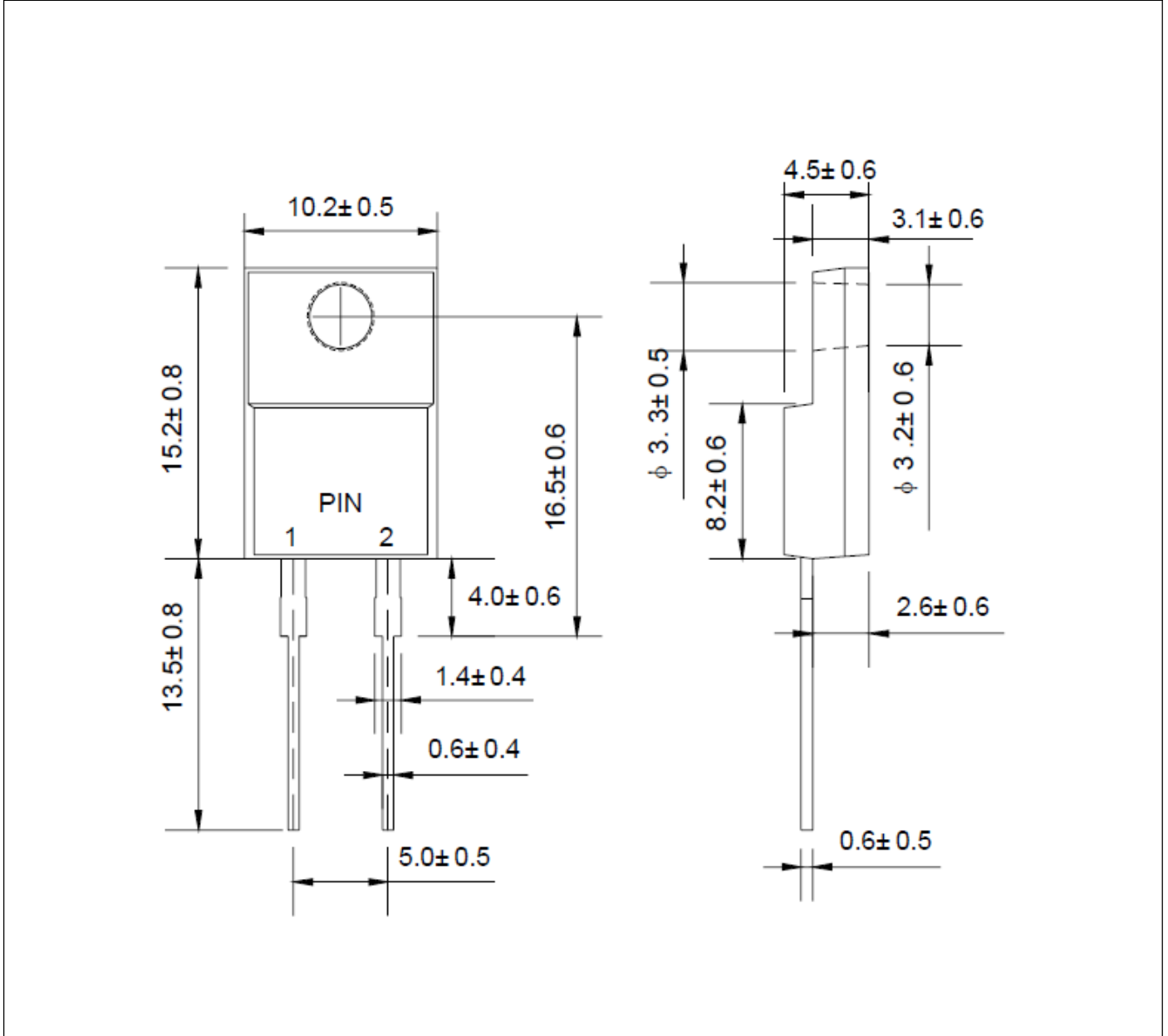

X-ON Electronics

Largest Supplier of Electrical and Electronic Components

Click to view similar products for [Rectifiers](#) category:

Click to view products by [Ruilongyuan](#) manufacturer:

Other Similar products are found below :

[70HFR40](#) [FR105 R0](#) [RL252-TP](#) [1N5397](#) [1N4005-TR](#) [1N4007-BP](#) [UFS120Je3/TR13](#) [20ETS12S](#) [RRE02VS6SGTR](#) [MS306](#) [A1N5404G-G](#)
[CRF02\(T5L,TEMQ\)](#) [ACGRB207-HF](#) [CLH07\(TE16L,Q\)](#) [CLH03\(TE16L,Q\)](#) [1N5395-TP](#) [UES1302](#) [ACGRC307-HF](#) [ACEFC304-HF](#) [DZ-](#)
[1380](#) [85HFR60](#) [40HFR60](#) [70HF120](#) [85HFR80](#) [SCF7500](#) [SM100](#) [ACGRA4001-HF](#) [SKN70/08](#) [NTE5819](#) [NTE5827](#) [NTE5828](#) [NTE5911](#)
[NTE5915](#) [NTE6104](#) [NTE6163](#) [NTE6164](#) [NTE6165](#) [NTE6364](#) [TSD3G](#) [SET130312](#) [NRVUS110VT3G](#) [UES1106](#) [UES1306](#)
[NRVUS240VT3G](#) [D5FE60-5063](#) [R4000GPS-TP](#) [D4015L56TP](#) [UES1306HR2](#) [FX20K120](#) [D20XB60-7101](#)