

Description

The P6KE series is designed specifically to protect sensitive electronic equipment from voltage transients induced by lightning and other transient voltage events.

Features

- I Fast response time
- I Matte tin lead-free Plated
- I Low incremental surge resistance
- I Halogen free and RoHS compliant
- I Typical I_R less than $1\mu A$ above 12V
- I Compatible with industrial standard package DO-15
- I For surface mounted applications to optimize board space
- I 600W peak pulse power capability with at 10/1000 μs waveform, repetition rate (duty cycle): 0.01%
- I High temperature soldering guaranteed:260°C/10 seconds



Electrical symbol

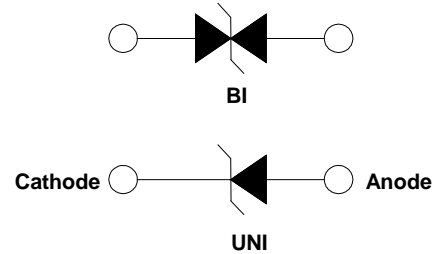

Part Number Code

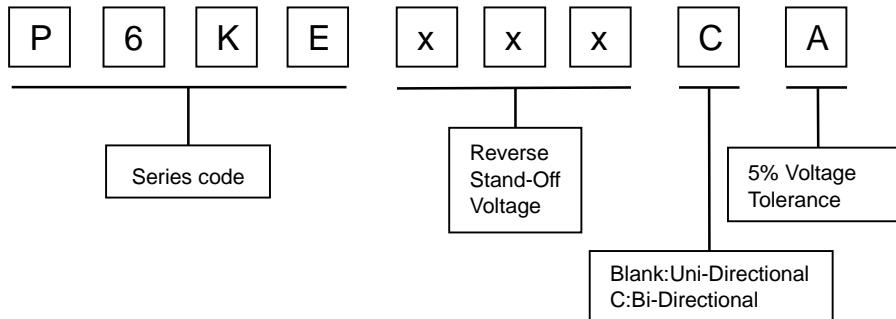

Mechanical Characteristics

| Rating | Symbol | Value | Units |
|--------------------------------------------------------------------------------------|----------------|------------|------------|
| Peak Pulse Power Dissipation by 10x1000 μs test Waveform(Fig.2) (Note1) | P_{PP} | 600 | W |
| Steady State Power Dissipation on infinite heat sink at $T_L=75^\circ C$ (Fig.6) | P_D | 5.0 | W |
| Peak Forward Surge Current, 8.3ms Single Half Sine Wave Unidirectional only (Note 2) | I_{FSM} | 100 | A |
| Maximum instantaneous forward voltage at 25 A for unidirectional only | V_F | 3.5/6.5 | V |
| Operating junction and Storage Temperature Range. | T_J, T_{STG} | -55 to 150 | $^\circ C$ |

Notes:

1. Non-repetitive current pulse , per Fig. 4 and derated above $T_A = 25^\circ C$ per Fig. 3.
2. Measured on 8.3ms single half sine wave or equivalent square wave, duty cycle=4 pulses per minute maximum.



Electrical Characteristics

| Type Number | | Reverse Stand-Off Voltage | Breakdown Voltage | | Test Current | Max. Clamping Voltage 10/1000µs | Max. Peak Pulse Current 10/1000µs | Reverse Leakage |
|-------------|-----------|---------------------------|-------------------|-----------|--------------|------------------------------------|--------------------------------------|-----------------|
| | | | $V_{BR} @ I_T$ | | | | | |
| | | UNI | BI | V_{RWM} | Min | Max | I_T | $V_C @ I_{PP}$ |
| | | V | V | V | mA | V | A | µA |
| P6KE6.8A | P6KE6.8CA | 5.80 | 6.45 | 7.14 | 10 | 10.5 | 57.0 | 1000 |
| P6KE7.5A | P6KE7.5CA | 6.40 | 7.13 | 7.88 | 10 | 11.3 | 53.0 | 500 |
| P6KE8.2A | P6KE8.2CA | 7.02 | 7.79 | 8.61 | 10 | 12.1 | 50.0 | 200 |
| P6KE9.1A | P6KE9.1CA | 7.78 | 8.65 | 9.55 | 1 | 13.4 | 45.0 | 50 |
| P6KE10A | P6KE10CA | 8.55 | 9.50 | 10.50 | 1 | 14.5 | 41.0 | 10 |
| P6KE11A | P6KE11CA | 9.40 | 10.50 | 11.60 | 1 | 15.6 | 38.0 | 5 |
| P6KE12A | P6KE12CA | 10.20 | 11.40 | 12.60 | 1 | 16.7 | 36.0 | 5 |
| P6KE13A | P6KE13CA | 11.10 | 12.40 | 13.70 | 1 | 18.2 | 33.0 | 1 |
| P6KE15A | P6KE15CA | 12.80 | 14.30 | 15.80 | 1 | 21.2 | 28.0 | 1 |
| P6KE16A | P6KE16CA | 13.60 | 15.20 | 16.80 | 1 | 22.5 | 27.0 | 1 |
| P6KE18A | P6KE18CA | 15.30 | 17.10 | 18.90 | 1 | 25.2 | 24.0 | 1 |
| P6KE20A | P6KE20CA | 17.10 | 19.00 | 21.00 | 1 | 27.7 | 22.0 | 1 |
| P6KE22A | P6KE22CA | 18.80 | 20.90 | 23.10 | 1 | 30.6 | 20.0 | 1 |
| P6KE24A | P6KE24CA | 20.50 | 22.80 | 25.20 | 1 | 33.2 | 18.0 | 1 |
| P6KE27A | P6KE27CA | 23.10 | 25.70 | 28.40 | 1 | 37.5 | 16.0 | 1 |
| P6KE30A | P6KE30CA | 25.60 | 28.50 | 31.50 | 1 | 41.4 | 14.4 | 1 |
| P6KE33A | P6KE33CA | 28.20 | 31.40 | 34.70 | 1 | 45.7 | 13.2 | 1 |
| P6KE36A | P6KE36CA | 30.80 | 34.20 | 37.80 | 1 | 49.9 | 12.0 | 1 |
| P6KE39A | P6KE39CA | 33.30 | 37.10 | 41.00 | 1 | 53.9 | 11.2 | 1 |
| P6KE43A | P6KE43CA | 36.80 | 40.90 | 45.20 | 1 | 59.3 | 10.1 | 1 |
| P6KE47A | P6KE47CA | 40.20 | 44.70 | 49.40 | 1 | 64.8 | 9.30 | 1 |
| P6KE51A | P6KE51CA | 43.60 | 48.50 | 53.60 | 1 | 70.1 | 8.60 | 1 |
| P6KE56A | P6KE56CA | 47.80 | 53.20 | 58.80 | 1 | 77.0 | 7.80 | 1 |
| P6KE62A | P6KE62CA | 53.00 | 58.90 | 65.10 | 1 | 85.0 | 7.10 | 1 |
| P6KE68A | P6KE68CA | 58.10 | 64.60 | 71.40 | 1 | 92.0 | 6.50 | 1 |
| P6KE75A | P6KE75CA | 64.10 | 71.30 | 78.80 | 1 | 103.0 | 5.80 | 1 |
| P6KE82A | P6KE82CA | 70.10 | 77.90 | 86.10 | 1 | 113.0 | 5.30 | 1 |
| P6KE91A | P6KE91CA | 77.80 | 86.50 | 95.50 | 1 | 125.0 | 4.80 | 1 |
| P6KE100A | P6KE100CA | 85.50 | 95.00 | 105.00 | 1 | 137.0 | 4.40 | 1 |
| P6KE110A | P6KE110CA | 94.00 | 105.00 | 116.00 | 1 | 152.0 | 4.00 | 1 |
| P6KE120A | P6KE120CA | 102.00 | 114.00 | 126.00 | 1 | 165.0 | 3.60 | 1 |
| P6KE130A | P6KE130CA | 111.00 | 124.00 | 137.00 | 1 | 179.0 | 3.30 | 1 |



Electrical Characteristics

| Type Number | | Reverse Stand-Off Voltage | Breakdown Voltage | | Test Current | Max. Clamping Voltage 10/1000µs | Max. Peak Pulse Current 10/1000µs | Reverse Leakage |
|-------------|-----------|---------------------------|-------------------|-----------|--------------|---------------------------------|-----------------------------------|-----------------|
| | | | $V_{BR} @ I_T$ | | | | | |
| | | UNI | BI | V_{RWM} | Min | Max | I_T | $V_C @ I_{PP}$ |
| | | V | V | V | mA | V | A | µA |
| P6KE150A | P6KE150CA | 128.00 | 143.00 | 158.00 | 1 | 207.0 | 2.90 | 1 |
| P6KE160A | P6KE160CA | 136.00 | 152.00 | 168.00 | 1 | 219.0 | 2.70 | 1 |
| P6KE170A | P6KE170CA | 145.00 | 162.00 | 179.00 | 1 | 234.0 | 2.60 | 1 |
| P6KE180A | P6KE180CA | 154.00 | 171.00 | 189.00 | 1 | 246.0 | 2.40 | 1 |
| P6KE200A | P6KE200CA | 171.00 | 190.00 | 210.00 | 1 | 274.0 | 2.20 | 1 |
| P6KE220A | P6KE220CA | 185.00 | 209.00 | 231.00 | 1 | 328.0 | 1.83 | 1 |
| P6KE250A | P6KE250CA | 214.00 | 237.00 | 263.00 | 1 | 344.0 | 1.75 | 1 |
| P6KE300A | P6KE300CA | 256.00 | 285.00 | 315.00 | 1 | 414.0 | 1.45 | 1 |
| P6KE350A | P6KE350CA | 300.00 | 332.00 | 368.00 | 1 | 482.0 | 1.25 | 1 |
| P6KE400A | P6KE400CA | 342.00 | 380.00 | 420.00 | 1 | 548.0 | 1.10 | 1 |
| P6KE440A | P6KE440CA | 376.00 | 418.00 | 462.00 | 1 | 602.0 | 1.00 | 1 |
| P6KE500A | P6KE500CA | 427.50 | 475.00 | 525.00 | 1 | 690.0 | 0.87 | 1 |
| P6KE520A | P6KE520CA | 444.60 | 494.00 | 546.00 | 1 | 717.6 | 0.84 | 1 |
| P6KE550A | P6KE550CA | 470.30 | 522.50 | 577.50 | 1 | 759.0 | 0.79 | 1 |
| P6KE600A | P6KE600CA | 513.00 | 570.00 | 630.00 | 1 | 828.0 | 0.72 | 1 |

I-V Curve Characteristics

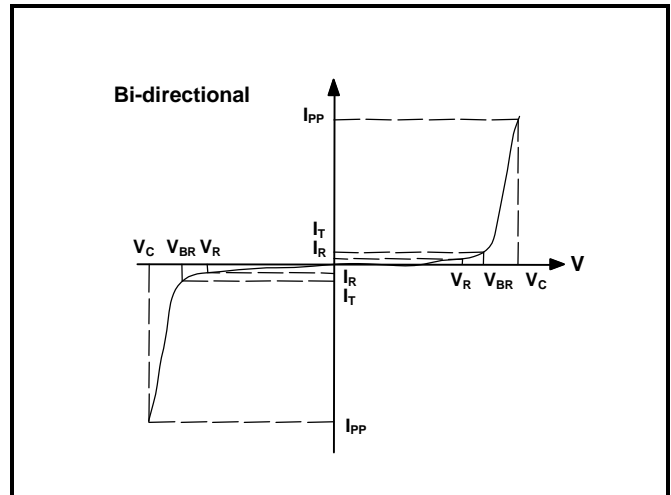
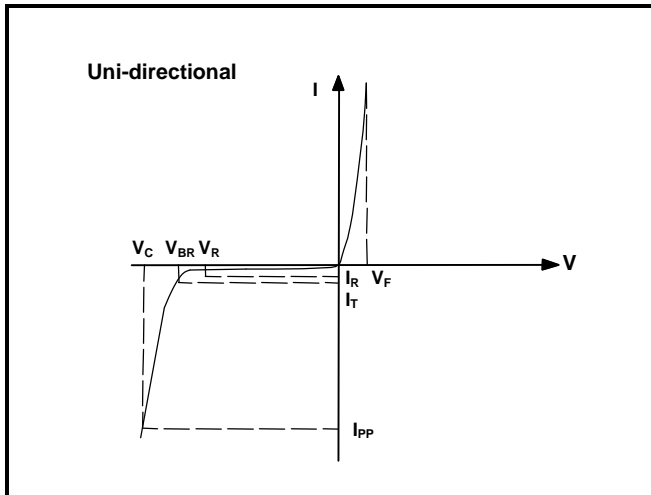

P_{PPM} Peak Pulse Power Dissipation -- Max power dissipation

V_R Stand-off Voltage -- Maximum voltage that can be applied to the TVS without operation

V_{BR} Breakdown Voltage -- Maximum voltage that flows though the TVS at a specified test current (I_T)

V_C Clamping Voltage -- Peak voltage measured across the TVS at a specified I_{ppm} (peak impulse current)

I_R Reverse Leakage Current – Current measured at V_R

V_F Forward Voltage Drop for Uni-directional



Ratings and Characteristic Curves ($T_A=25^\circ\text{C}$ unless otherwise noted)

Figure 1 - TVS Transients Clamping Waveform

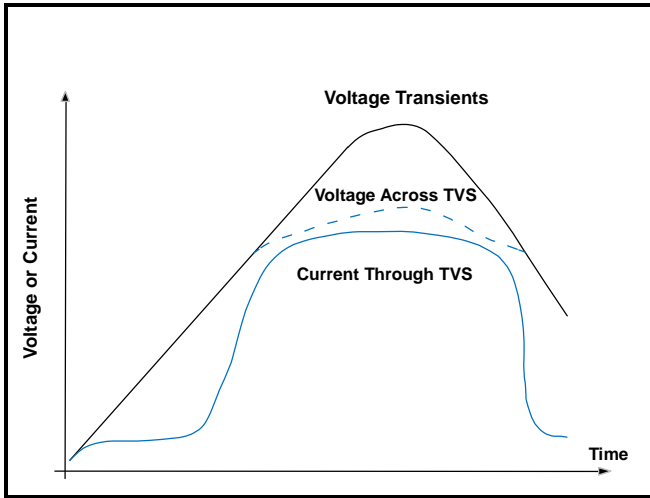

Figure 2 - Peak Pulse Power Rating Curve

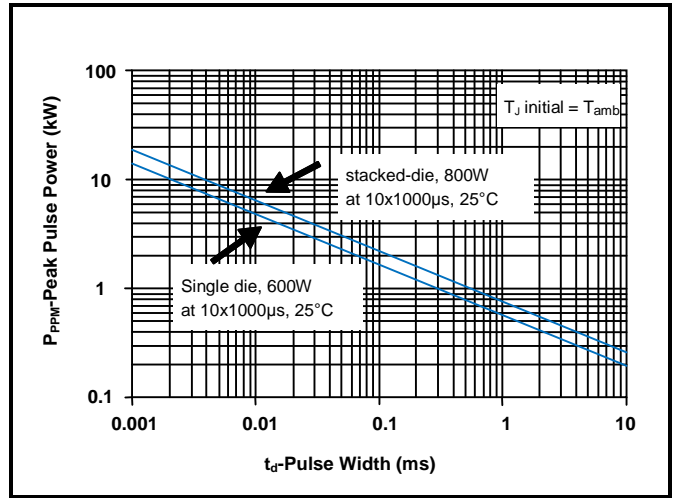

Figure 3 - Pulse Derating Curve

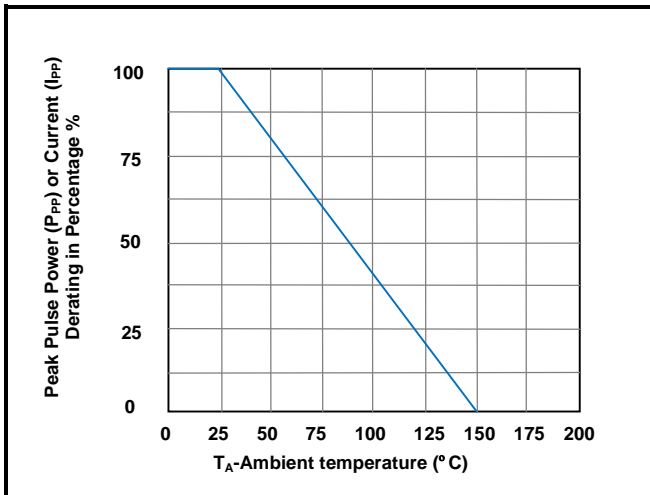

Figure 4 - Pulse Waveform

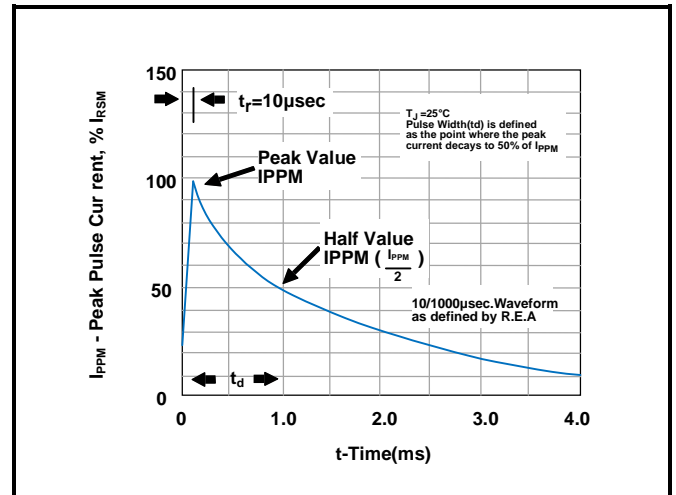

Figure 5 - Typical Junction Capacitance

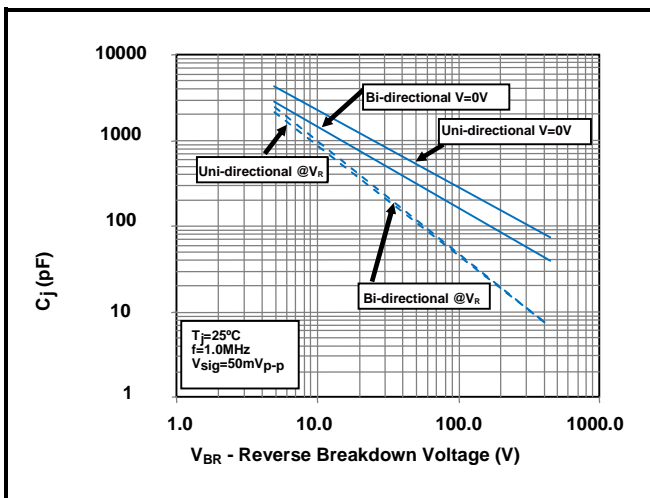

Figure 6 - Steady State Power Derating Curve

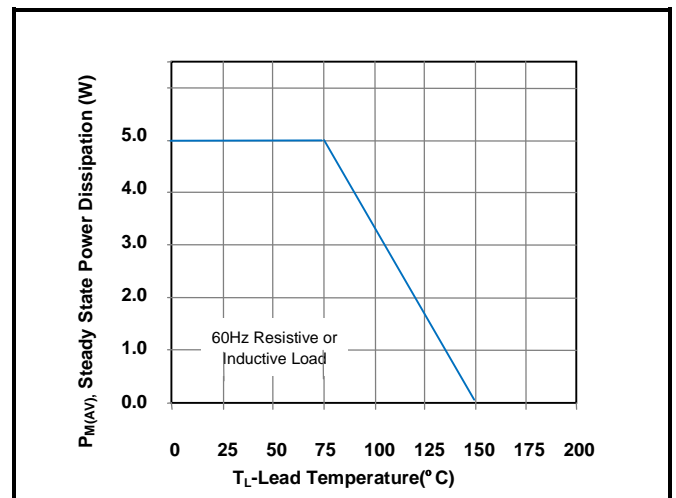
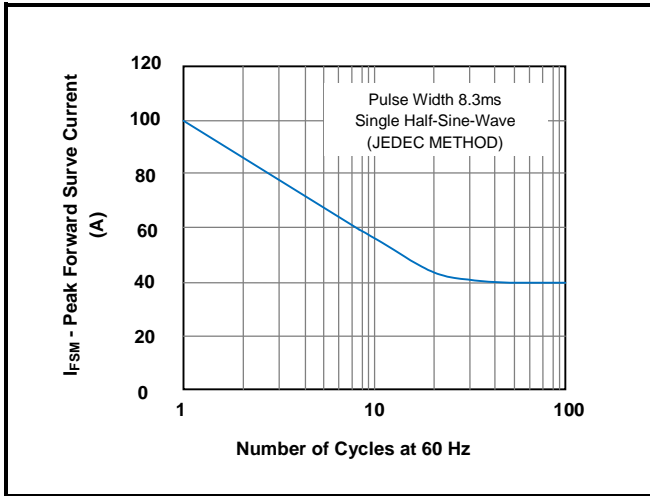
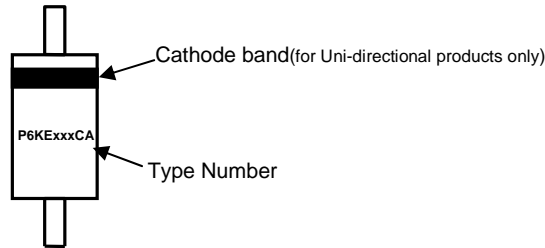

Figure 7 - Maximum Non-Repetitive Surge Current



Part Marking System



Dimensions

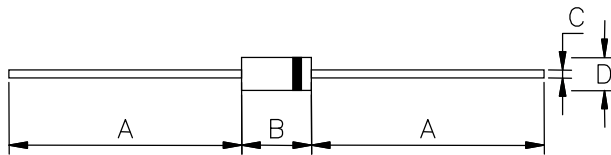

| DIM | Millimeters | | Inches | |
|-----|-------------|------|--------|-------|
| | Min | Max | Min | Max |
| A | 25.40 | - | 1.000 | - |
| B | 5.80 | 7.60 | 0.228 | 0.299 |
| C | 0.70 | 0.90 | 0.028 | 0.035 |
| D | 2.60 | 3.60 | 0.102 | 0.142 |



Taping and Reel Specifications

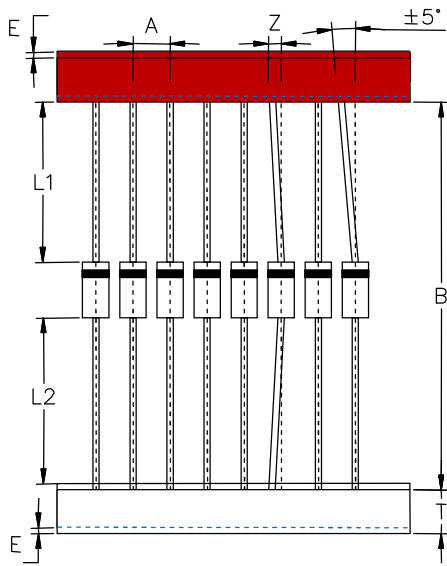

| Symbol | Millimeters | Inches |
|--------|-------------|-------------|
| A | 5.08±0.5 | 0.2±0.019 |
| B | 53.0±1.0 | 2.087±0.039 |
| Z | 1.2Max | 0.047 Max |
| T | 6.0±0.4 | 0.236±0.015 |
| E | 0.8Max | 0.031 Max |
| L1-L2 | 1.0Max | 0.039 Max |

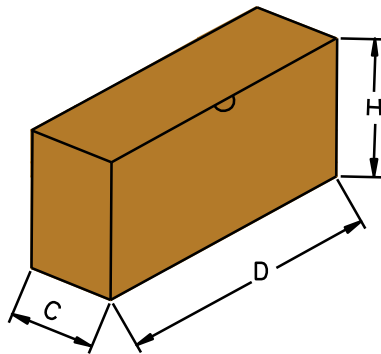

| Symbol | Millimeters | Inches |
|----------|---------------------|-------------|
| D | 250.0±5.0 | 9.843±0.197 |
| C | 75.0±5.0 | 2.953±0.197 |
| H | 114.0±5.0 | 4.488±0.197 |
| Quantity | 2000PCS / inner box | |



X-ON Electronics

Largest Supplier of Electrical and Electronic Components

Click to view similar products for [ESD Suppressors / TVS Diodes](#) category:

Click to view products by [Ruilongyuan](#) manufacturer:

Other Similar products are found below :

[60KS200C](#) [D18V0L1B2LP-7B](#) [D5V0F4U5P5-7](#) [DESD5V0U1BB-7](#) [NTE4902](#) [P4KE27CA](#) [P6KE11CA](#) [P6KE39CA-TP](#) [P6KE8.2A](#)
[SA110CA](#) [SA60CA](#) [SA64CA](#) [SMBJ12CATR](#) [SMBJ33CATR](#) [SMBJ8.0A](#) [ESD101-B1-02ELS E6327](#) [ESD105-B1-02EL E6327](#) [ESD112-B1-02EL E6327](#) [ESD119B1W01005E6327XTSA1](#) [ESD5V0L1B02VH6327XTSA1](#) [ESD7451N2T5G](#) [19180-510](#) [CPDT-5V0USP-HF](#)
[3.0SMCJ33CA-F](#) [3.0SMCJ36A-F](#) [HSPC16701B02TP](#) [D3V3Q1B2DLP3-7](#) [D55V0M1B2WS-7](#) [DESD5V0U1BL-7B](#) [DRTR5V0U4SL-7](#)
[SCM1293A-04SO](#) [ESD200-B1-CSP0201 E6327](#) [SM12-7](#) [SMF8.0A-TP](#) [SMLJ45CA-TP](#) [CEN955 W/DATA](#) [82350120560](#) [VESD12A1A-](#)
[HD1-GS08](#) [CPDUR5V0R-HF](#) [CPDQC5V0U-HF](#) [CPDQC5V0USP-HF](#) [CPDQC5V0-HF](#) [D1213A-01LP4-7B](#) [D1213A-02WL-7](#)
[MMAD1108/TR13](#) [5KP100A](#) [5KP15A](#) [5KP18A](#) [5KP48A](#) [5KP90A](#)