

Features

- I RoHS compliant.
- I Bilateral symmetrical.
- I Less decay at on/off state.
- I Approximately zero leaking current before clamping voltage
- I High capability to withstand repeated lightning strikes.
- I Low electrode capacitance($\leq 1.0\text{pF}$) and high isolation ($\geq 100\text{M}\Omega$).
- I Temperature, humidity and lightness insensitive.
- I Working temperature range: $-45^{\circ}\text{C} \sim +85^{\circ}\text{C}$
- I Storing temperature range: $-45^{\circ}\text{C} \sim +85^{\circ}\text{C}$

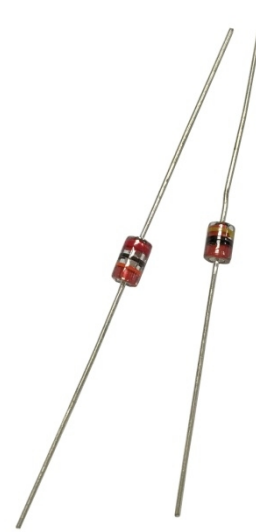

Applications

- I Power Supplies
- I Motor sparks eliminating
- I Relay switching spark absorbing
- I Data line pulse guarding
- I Telephone/Fax/Modem
- I High frequency signal transmitters/receivers
- I Satellite antenna
- I Radio amplifiers
- I Alarm systems
- I Cathode ray tubes in Monitors/ Television Viewing Systems

Part Number Code

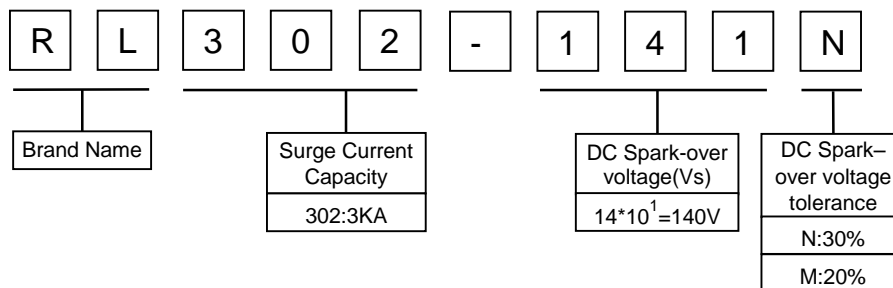

Electrical Characteristics

Type Number	DC Spark-Over Voltage	Min. Insulation Resistance		Max. Capacitance (1kHz-6Vmax.)	Surge Current Capacity	Surge Life Test @8/20μs
	Vs	Test Voltage	I _R	C _j	8/20μs	
	V	V	MΩ	pF	A	
RL302-141N	140(126~210)	50	100	1	3000	150A 10 times
RL302-181N	180±30%	50	100	1	3000	150A 10 times
RL302-201M	200±20%	100	100	1	3000	150A 10 times
RL302-301M	300±20%	100	100	1	3000	150A 10 times
RL302-401M	400±20%	250	100	1	3000	150A 10 times
RL302-501M	500±20%	250	100	1	3000	150A 10 times
RL302-601M	600±20%	250	100	1	3000	150A 10 times
RL302-701M	700±20%	250	100	1	3000	150A 10 times
RL302-102M	1000±20%	500	100	1	3000	150A 10 times
RL302-122M	1200±20%	500	100	1	3000	150A 10 times
RL302-152M	1500±20%	500	100	1	3000	150A 10 times
RL302-202M	2000±20%	500	100	1	3000	150A 10 times
RL302-242M	2400±20%	500	100	1	3000	150A 10 times
RL302-302M	3000±20%	500	100	1	3000	150A 10 times

Test Methods And Results

Test Item	Test Method	Specification
DC Spark-over Voltage Vs(V)	Measure starting discharge voltage (Vs) by gradually increasing applied DC voltage. Test current is 0.5mA max. And the DC voltage ascends up within 500V/second.	It depends on each spec.
Insulation Resistance	Measure the insulation resistance across the terminal at regular voltage. But the test voltage doesn't over the DC spark-over voltage.	100MΩ min.
Capacitance Cj(pF)	Measure the electrostatic capacitance by applying a voltage of less than 6V (at 1KHz) between terminals.	1pF max.
Life	10KV with 1500pf condenser is discharged through 0Ω resistor. 200 times at an interval of 10sec.	DC spark-over voltage JSE: Δ Vs/Vs ≤30%
Surge Current Capacity	1.2/50μs & 8/20μs, 3000A, electrically connected with a resistor (4-6 Ω), ±5 times, each time interval 60 seconds. Thereafter, outer appearance shall be visually examined.	No crack and no failures
Cold Resistance	Measurement after -40℃ /1000 HRS & normal temperature/2 HRS.	Features are conformed to rated spec.
Heat Resistance	Measurement after 125℃ /1000 HRS & normal temperature/2 HRS.	
Humidity Resistance	Measurement after humidity 90~95 ℃ (45 ℃)/1000 HRS & normal temperature/2 HRS.	
Temperature Cycle	10 times repetition of cycle -40 ℃ /30min →normal, temp/2 min →125℃ /30min, measurement after normal temp/2 HRS.	
Solder Ability	Apply flux and immerse in molten solder 230±5℃ for 3sec up to the point of 1.5mm from body. Check for solder adhesion.	Lead wire is evenly covered by solder.
Solder Heat	Measurement after lead wire is dipped up to the point of 1.5mm from body into 260±5℃ solder for 10sec.	Conformed to rated spec.
Pull Strength	Apply 0.5kg load for 10sec.	Lead shall not pull out to snap.
Flexural Strength	Bend lead wire at the point of 2mm from body under 0.25 load and back to its original point. Repeat 1 time.	

Recommended Soldering Conditions

Flow Soldering Conditions

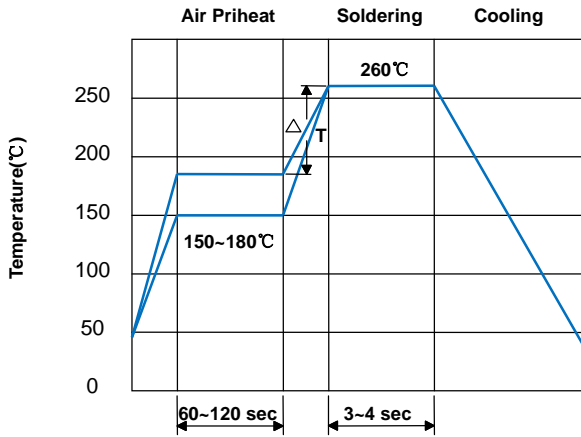

Hand Soldering

Solder iron temperature: $350 \pm 5^\circ\text{C}$
Heating time: 3 seconds max.

General attention to soldering

1. High soldering temperatures and long soldering times can cause leaching of the termination, decrease in adherence strength, and the change of characteristic may occur.
2. For soldering, please refer to the soldering curves above. However, please keep exposures to temperatures exceeding 200°C to fewer than 50 seconds.
3. Please use a mild flux (containing less than 0.2wt% Cl). Also, if the flux is water soluble, be sure to wash thoroughly to remove any residue from the underside of components that could affect resistance.

- 1) Time shown in the above figures is measured from the point when chip surface reaches temperature.
- 2) Temperature difference in high temperature part should be within 110°C
- 3) After soldering, do not force cool, allow the parts to cool gradually.

Cleaning

When using ultrasonic cleaning, the board may resonate if the output power is too high. Since this vibration can cause cracking or a decrease in the adherence of the termination, we recommend that you use the conditions below.

Frequency: 40kHz max.
Output power: 20W/liter
Cleaning time: 5 minutes max.

Dimensions

DC Spark-Over Voltage: 140~1200V

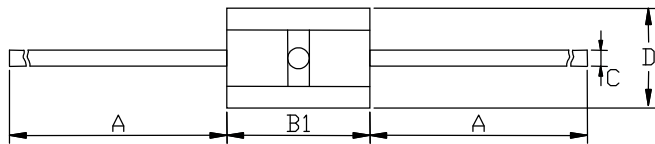

DIM	Millimeters	Inches
A	28 ± 3.0	1.102 ± 0.118
B1	4.3 ± 0.3	0.169 ± 0.012
B2	5.3 ± 0.3	0.209 ± 0.012
C	0.5 ± 0.05	0.02 ± 0.002
D	$\Phi 3.1 \pm 0.3$	$\Phi 0.122 \pm 0.012$

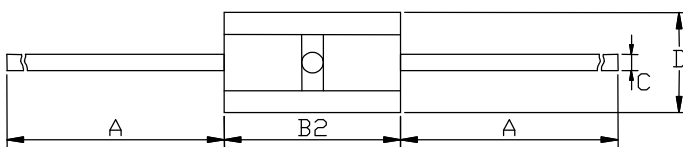

DC Spark-Over Voltage: 1500~3000V

Packaging Information

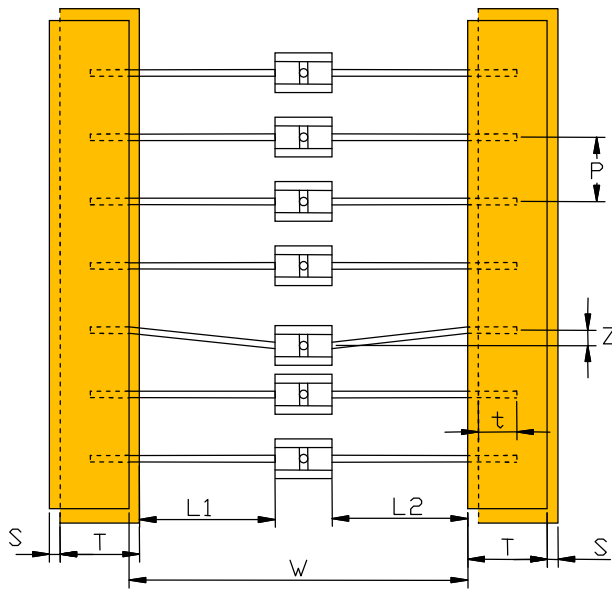

Symbol	Millimeters	Inches
W	52.5±1.5	2.067±0.059
P	5.0±0.5	0.197±0.02
L1-L2	1.0 max	0.039max
T	6.0±1.0	0.236±0.039
Z	1.2max	0.047max
t	3.2max	0.126max
S	0.8max	0.031max
A	75.0	2.953
B	68.0	2.677
C	255.0	10.039
Quantity: 1500PCS / inner box		

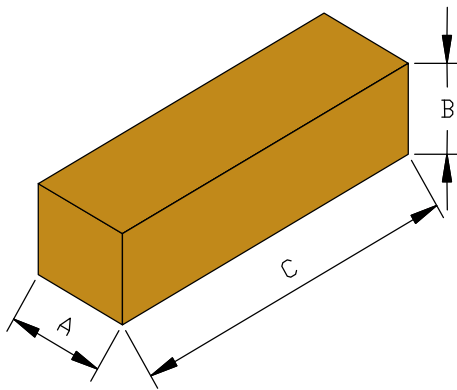

X-ON Electronics

Largest Supplier of Electrical and Electronic Components

Click to view similar products for [Gas Discharge Tubes - GDTs / Gas Plasma Arrestors](#) category:

Click to view products by [Ruilongyuan](#) manufacturer:

Other Similar products are found below :

[PMT1023004](#) [PMT1025001](#) [RF3161-000](#) [PMT1035004](#) [PMT1040004](#) [PMT809006](#) [CG2250](#) [CG2800](#) [CG31.5L](#) [GT-SMD181240012-TR](#)
[WPGT-2N145B6L](#) [WPGT-2N230B6L](#) [WPGT-2N470B6L](#) [WPGT-2R470B6L](#) [WPGT-2RM230A6L](#) [WPGT-2RM350A6L](#) [WPGT-](#)
[2RM70A6L](#) [WPGT-2RM90A6L](#) [WPGT-2S145](#) [WPGT-2S350](#) [WPGT-2S470](#) [WPGT-3R350CF](#) [WPGT-3R350G1](#) [WPGT-3R90G1](#) [WPGT-](#)
[3R75G1](#) [WPGT-3R470G1](#) [WPGT-3R250C](#) [WPGT-3R230G1](#) [WPGT-2S230](#) [WPGT-2RM470A6L](#) [WPGT-2RM145A6L](#) [WPGT-2R3000B8L](#)
[WPGT-2R2700B8L](#) [WPGT-2R1000B8L](#) [WPGT-2N90B6L](#) [WPGT-2N70B6L](#) [WPGT-2N350B6L](#) [WPGT-2N230B6L1](#) [CG90](#) [CG2230](#)
[CG2145](#) [CG21000](#) [GT-SMD181215012-TR](#) [9071.99.0547 \(73_Z-0-0-547\)](#) [B88069X6940B152](#) [V20-1+NPE-280](#) [V20-3+NPE+FS-280](#)
[SD09-V24 9](#) [C50-0-255](#) [SG24PA300](#)