

Features

- I Electrical equivalents to leaded types
- I SMD plastic package.
- I RoHS-compatible. AECQ101
- I Suitable for lead-free soldering
- I PSpice models available
- I Cylindrical varistor element, encapsulated.
- I Encapsulation: thermoplastic, flame-retardant to UL 94 V-0.
- I Termination: tinned copper alloy, suitable for lead-free wave and reflow soldering, and compatible with tin/lead solder.
- I Operating Temperature: -40°C to +125°C
- I Storage Temperature: -40 °C to +150°C

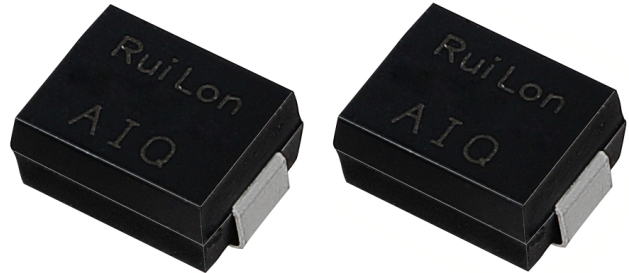

Applications

- I Power supplies for telecommunication systems
- I Protection for LED circuits
- I Protection for consumer, industrial equipment
- I Protection for automotive electronics

APPLICABLE STANDARDS

- I CUL
- I CQC (GB/T10193, GB/T10194, GB4943.1, GB8898)
- I TUV

Part Number Code

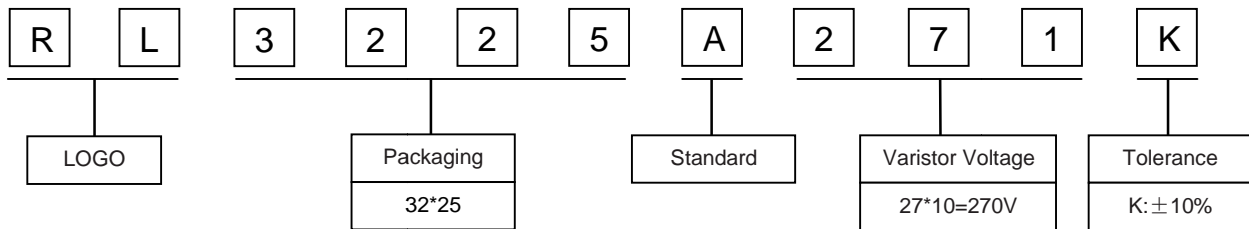

Electrical Characteristics

Type Number	Varistor Voltage	Max. Allowable Voltage		Max. Energy (10/1000µs)	Max. Clamping Voltage (8/20µs)		Withstanding Surge Current (8/20µs)	8/20µs&1.2/50µs @Ri=2 Ω		Maximum DC Leakage Current	C _{typ} (1 kHz, 1 V)
	V _{1mA} (V)	V _{AC} (V)	V _{DC} (V)	(J)	I _P (A)	V _C (V)	I(A) @1 Time	KV	Times	µA	pF
RL3225A271K	243~297	175	225	14.2	10	455	1200	2	40	20	150
RL3225A471K	423~517	300	385	24.7	10	775	1200	2	40	20	105
RL3225A511K	459~561	320	418	26.8	10	842	1200	2	40	20	100
RL3225A561K	504~616	350	460	29.4	10	920	1200	2	40	20	90

General Technical Data

Taping Package Storage Condition	Storage Temperature	-10~40°C
	Relative Humidity	≦ 75%
	Storage Time	12 Months max

(Do not use this product in corrosive gases or direct sunlight environment preservation)



Reliability Test (Note: For CU varistors mounted on PCB by reflow soldering.)

Items	Test Condition/Description	Specification
Varistor voltage	The voltage between two terminals with the specified measuring current applied is called V_V (1 mA _{DC} @ 0.2 ... 2 s).	To meet the specified value
Clamping voltage	The maximum voltage between two terminals with the specified standard impulse current (8/20 μ s) applied.	To meet the specified value
Endurance at upper Category temperature	1000 h at UCT After having continuously applied the maximum allowable AC voltage at UCT ± 2 °C for 1000 h, the specimen shall be stored at room temperature and normal humidity for 1 to 2 h. Thereafter, the change of V_V shall be measured.	$ \Delta V/V(1mA) \leq 10\%$
Surge current derating, 8/20 μ s	10 surge currents (8/20 μ s), unipolar, interval 30 s, amplitude corresponding to derating curve for 10 impulses at 20 μ s	$ \Delta V/V(1mA) \leq 10\%$ (measured in direction of surge current) No visible damage
Surge current derating, 2 ms	10 surge currents (2 ms), unipolar, interval 120 s, amplitude corresponding to derating curve for 10 impulses at 2 ms	$ \Delta V/V(1mA) \leq 10\%$ (measured in direction of surge current) No visible damage
Climatic sequence	The specimen shall be subjected to: a) dry heat at UCT, 16 h, IEC 60068-2-2, test Ba b) damp heat, 1st cycle: 55 °C, 93% r. H., 24 h, IEC 60068-2-30, test Db. c) cold, LCT, 2 h, IEC 60068-2-1, test Aa. d) damp heat, additional 5 cycles: 55 °C/25 °C, 93% r. H., 24 h/cycle, IEC 60068-2-30, test Db. Then the specimen shall be stored at room temperature and normal humidity for 1 to 2h. Thereafter, the change of V_V shall be measured. Thereafter, insulation resistance R_{ins} shall be measured at $V = 500V$.	$ \Delta V/V(1mA) \leq 10\%$ $R_{ins} \geq 100 M\Omega$
Rapid change of temperature	IEC 60068-2-14, test Na, LCT/UCT, dwell time 30 min, 5 cycles	$ \Delta V/V(1mA) \leq 5\%$ No visible damage
Damp heat, steady state	IEC 60068-2-78, test Ca The specimen shall be subjected to 40 ± 2 °C, 90 to 95% r. H. for 56 days without load / with 10% of the maximum continuous DC operating voltage V_{DC} . Then stored at room temperature and normal humidity for 1 to 2 h. Thereafter, the change of V_V shall be measured. Thereafter, insulation resistance R_{ins} shall be measured at $V = 500 V$ (insulated varistors only).	$ \Delta V/V(1mA) \leq 10\%$ $R_{ins} \geq 100 M\Omega$
Solderability	IEC 60068-2-58, test Td1, method 1 - solder bath, Sn96, 5Ag3Cu0.5 $T = 245 \pm 3$ °C , $t = 2$ s	The terminations shall be uniformly tinned for soldering test.
Resistance to soldering heat	IEC 60068-2-58, test Td2, method 1 - solder bath, Sn96, 5Ag3Cu0.5 $T = 260 \pm 5$ °C , $d = 10 \pm 1$ s	$ \Delta V/V(1mA) \leq 5\%$ No visible damage
Robustness of termination	Substrate bending test : IEC 60068-2-21, test Ue1 Deflection = 2 mm , $t = 60$ s	$ \Delta V/V(1mA) \leq 10\%$ No visible damage
	Shear test: IEC 60068-2-21, test Ue3 Force = 5 N , $t = 10 \pm 1$ s	$ \Delta V/V(1mA) \leq 10\%$ No visible damage
Vibration	IEC 60068-2-6, test Fc, method B4: Frequency range: 10 ... 55 Hz , Amplitude: 0.75 mm or 98 m/s ² , Duration: 6 h (3 · 2 h) Pulse: sine wave After repeatedly applying a single harmonic vibration according to the table above. The change of V_V shall be measured and the specimen shall be visually examined.	$ \Delta V/V(1mA) \leq 5\%$ No visible damage
Bump	IEC 60068-2-27, test Ea: Pulse duration: 6 ms , Max. acceleration: 400 m/s ² Number: 6 x 5000 shocks , Pulse shape: half sine	$ \Delta V/V(1mA) \leq 5\%$ No visible damage
Fire hazard	IEC 60695-11-5 (needle flame test) Severity: vertical 10 s	5 s max.



Soldering Parameters - Reflow Soldering (Surface Mount Devices)

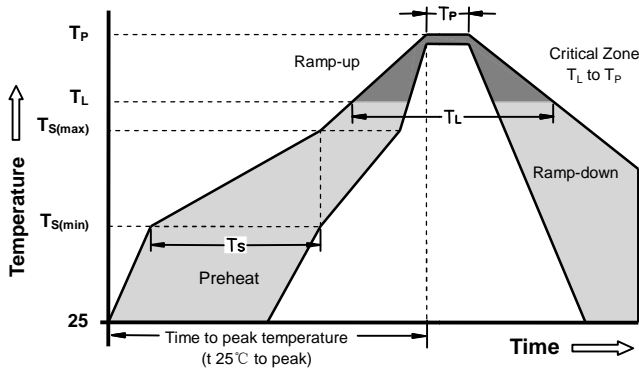

Reflow Condition		Pb - Free assembly
Pre Heat at	-Temperature Min ($T_{s(min)}$)	150°C
	-Temperature Max ($T_{s(max)}$)	200°C
	- Time (min to max) (t_s)	60 -180 Seconds
Average ramp up rate (Liquids Temp T_L) to peak		3°C/second max
$T_{s(max)}$ to T_L - Ramp-up Rate		3°C/second max
Reflow	- Temperature (T_L) (Liquids)	217°C
	- Time (min to max) (t_s)	60 -150 Seconds
Peak Temperature (T_p)		260 +0/-5°C
Time within 5°C of actual peak Temperature (t_p)		20 - 40 Seconds
Ramp-down Rate		6°C/second max
Time 25°C to peak Temperature (T_s)		8 minutes Max
Do not exceed		260°C

Precaution for soldering

Note that this product will be easily damaged by rapid heating, rapid cooling or local heating.
Do not give heat shock over 100°C in the process of soldering. We recommend to take preheating and gradual cooling

Soldering gun procedure

Note the follows, in case of using solder gun for replacement.
1)The tip temperature must be less than 280 for the period within 3 seconds by using soldering gun under 30W
2) The soldering gun tip shall not touch this product directly.

Soldering volume

Note that excess of soldering volume will easily get crack the body of this product.

Dimensions And Recommended Pad Layout

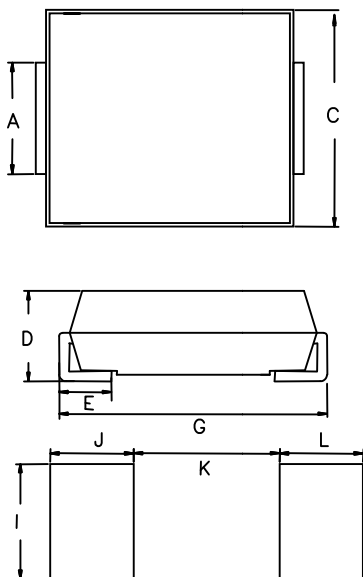

DIM	Millimeters	Inches
A	3.0±0.3	0.118±0.012
C	6.3±0.3	0.248±0.012
D	4.0±2.0	0.157±0.079
E	1.5±0.3	0.059±0.012
G	8.0±0.3	0.315±0.012
I	3.5	0.138
J	2.8	0.110
K	4.5	0.177
L	2.8	0.110



Taping and Reel Specifications

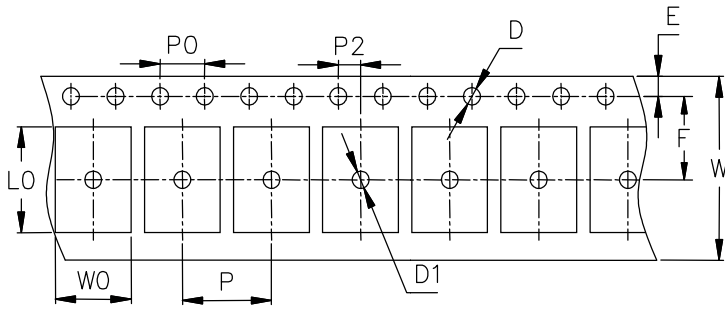

Symbol	Millimeters	Inches
W	16.00±0.30	0.630±0.012
E	1.75±0.10	0.069±0.004
F	7.50±0.10	0.295±0.004
D	1.55±0.05	0.061±0.002
D1	Φ1.50±0.10	Φ0.059±0.004
P	12.00±0.10	0.471±0.004
P0	4.00±0.10	0.157±0.004
P2	2.00±0.10	0.079±0.004

Packing Specifications

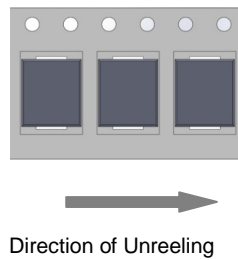
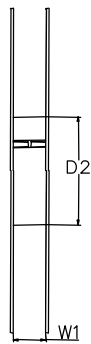
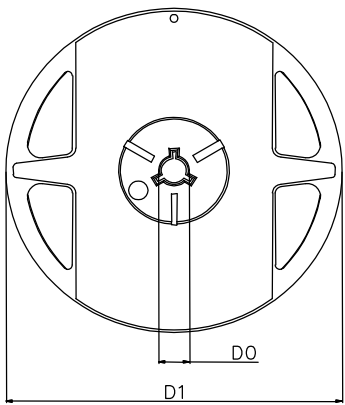

Symbol	Millimeters	Inches
D1	380+0/-2.0	14.961+0/-0.079
D2	Φ100.0±3.0	Φ3.937±0.118
W1	16.4±0.2	0.646±0.008

Taping Specifications

There shall be the portion having no product in both the head and the end of taping, and there shall be the cover tape in the heat of taping.

Quantity of products in the taping package

SIZE EIA (EIAJ)	3225
Standard Packing Quantity (PCS/reel)	1500

X-ON Electronics

Largest Supplier of Electrical and Electronic Components

Click to view similar products for [Varistors](#) category:

Click to view products by [Ruilongyuan](#) manufacturer:

Other Similar products are found below :

[R71ZOV151HC](#) [B72205S271K111](#) [B72214S110K151](#) [B72214S251K151](#) [B72540E250K62](#) [NTE1V020](#) [NTE1V130](#) [25FN511K](#)
[S10K11G5S5](#) [ERZ-C14DK361U](#) [ERZ-C20DK221U](#) [ERZ-C32CK201B](#) [207869-1](#) [AS-13](#) [B72214S200K551](#) [B72280B112K1](#) [B72540E](#)
[350K 62](#) [B72590D360A60](#) [B72650M301K93](#) [B72670M1140K72](#) [TVZ18EC271KBS](#) [TVZ20EB911KBS](#) [TVZ25D201KBS](#) [TVZ25D241KBS](#)
[VDRH20X230BSE](#) [VZ07D220KBS](#) [VZ40D241KQ-N](#) [VZ40D241K](#) [VZ25D511KBS-N](#) [VZ20E511KBSX](#) [VZ20E221KBSX](#)
[VZ10D471KBS-N](#) [ERZ-V20R221](#) [20A9FN241K](#) [B72205S350K211](#) [B72214S110K551](#) [B72510E140K62](#) [B72650M350K72](#)
[TVZ25DN271KBS](#) [TVZ25D301KBS](#) [TVZ20EC911KBS](#) [TVZ20EBN911KBS](#) [TVZ18EC471KBS](#) [B72220S350K101](#) [B72540E300K62](#)
[TND10V-271KB00AAA0](#) [NTE1V030](#) [NTE1V275](#) [NTE2V015](#) [NTE2V035](#)