

**Features**

- I Electrical equivalents to leaded types
- I SMD plastic package.
- I RoHS-compatible. AECQ101
- I Suitable for lead-free soldering
- I PSpice models available
- I Cylindrical varistor element, encapsulated.
- I Encapsulation: thermoplastic, flame-retardant to UL 94 V-0.
- I Termination: tinned copper alloy, suitable for lead-free wave and reflow soldering, and compatible with tin/lead solder.
- I Operating Temperature: -40°C to +125°C
- I Storage Temperature: -40 °C to +150°C

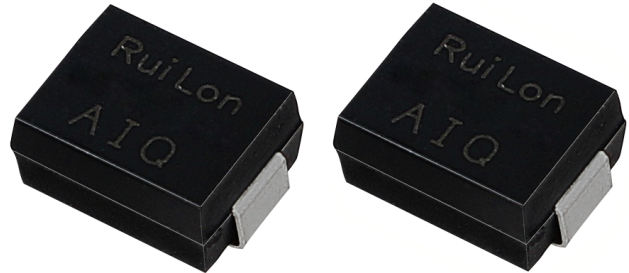

**Applications**

- I Power supplies for telecommunication systems
- I Protection for LED circuits
- I Protection for consumer, industrial equipment
- I Protection for automotive electronics

**APPLICABLE STANDARDS**

- I CUL
- I CQC (GB/T10193, GB/T10194, GB4943.1, GB8898)
- I TUV

**Part Number Code**

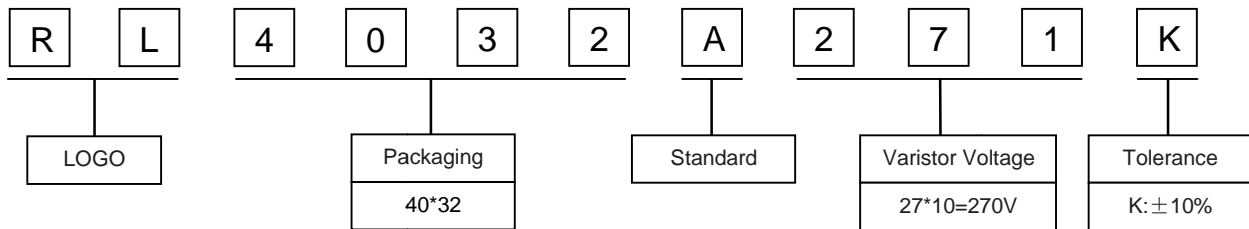

**Electrical Characteristics**

Type Number	Varistor Voltage	Max. Allowable Voltage		Max. Energy (10/1000µs)	Max. Clamping Voltage (8/20µs)		Withstanding Surge Current (8/20µs)	8/20µs&1.2/50µs @Ri=2 Ω		Maximum DC Leakage Current	C <sub>typ</sub> (1 kHz, 1 V)
	V <sub>1mA</sub> (V)	V <sub>AC</sub> (V)	V <sub>DC</sub> (V)	(J)	I <sub>P</sub> (A)	V <sub>C</sub> (V)	I(A) @1 Time	KV	Times	µA	pF
RL4032A271K	243~297	175	225	30.4	25	455	2500	4	40	20	330
RL4032A471K	423~517	300	385	52.9	25	775	2500	4	40	20	190
RL4032A511K	459~561	320	418	52.9	25	842	2500	4	40	20	180
RL4032A561K	504~616	350	460	52.9	25	920	2500	4	40	20	170

**General Technical Data**

Taping Package Storage Condition	Storage Temperature	-10~40°C
	Relative Humidity	≦ 75%
	Storage Time	12 Months max

(Do not use this product in corrosive gases or direct sunlight environment preservation)



**Reliability Test (Note: For CU varistors mounted on PCB by reflow soldering.)**

Items	Test Condition/Description	Specification
Varistor voltage	The voltage between two terminals with the specified measuring current applied is called $V_V$ (1 mA <sub>DC</sub> @ 0.2 ... 2 s).	To meet the specified value
Clamping voltage	The maximum voltage between two terminals with the specified standard impulse current (8/20 μs) applied.	To meet the specified value
Endurance at upper Category temperature	1000 h at UCT After having continuously applied the maximum allowable AC voltage at UCT ±2 °C for 1000 h, the specimen shall be stored at room temperature and normal humidity for 1 to 2 h. Thereafter, the change of $V_V$ shall be measured.	$ \Delta V/V(1mA)  \leq 10\%$
Surge current derating, 8/20 μs	10 surge currents (8/20 μs), unipolar, interval 30 s, amplitude corresponding to derating curve for 10 impulses at 20 μs	$ \Delta V/V(1mA)  \leq 10\%$ (measured in direction of surge current) No visible damage
Surge current derating, 2 ms	10 surge currents (2 ms), unipolar, interval 120 s, amplitude corresponding to derating curve for 10 impulses at 2 ms	$ \Delta V/V(1mA)  \leq 10\%$ (measured in direction of surge current) No visible damage
Climatic sequence	The specimen shall be subjected to: a) dry heat at UCT, 16 h, IEC 60068-2-2, test Ba b) damp heat, 1st cycle: 55 °C, 93% r. H., 24 h, IEC 60068-2-30, test Db. c) cold, LCT, 2 h, IEC 60068-2-1, test Aa. d) damp heat, additional 5 cycles: 55 °C/25 °C, 93% r. H., 24 h/cycle, IEC 60068-2-30, test Db. Then the specimen shall be stored at room temperature and normal humidity for 1 to 2h. Thereafter, the change of $V_V$ shall be measured. Thereafter, insulation resistance $R_{ins}$ shall be measured at $V = 500V$ .	$ \Delta V/V(1mA)  \leq 10\%$ $R_{ins} \geq 100 M\Omega$
Rapid change of temperature	IEC 60068-2-14, test Na, LCT/UCT, dwell time 30 min, 5 cycles	$ \Delta V/V(1mA)  \leq 5\%$ No visible damage
Damp heat, steady state	IEC 60068-2-78, test Ca The specimen shall be subjected to 40 ±2 °C, 90 to 95% r. H. for 56 days without load / with 10% of the maximum continuous DC operating voltage $V_{DC}$ . Then stored at room temperature and normal humidity for 1 to 2 h. Thereafter, the change of $V_V$ shall be measured. Thereafter, insulation resistance $R_{ins}$ shall be measured at $V = 500 V$ (insulated varistors only).	$ \Delta V/V(1mA)  \leq 10\%$ $R_{ins} \geq 100 M\Omega$
Solderability	IEC 60068-2-58, test Td1, method 1 - solder bath, Sn96, 5Ag3Cu0.5 $T = 245 \pm 3 \text{ }^\circ\text{C}$ , $t = 2 \text{ s}$	The terminations shall be uniformly tinned for soldering test.
Resistance to soldering heat	IEC 60068-2-58, test Td2, method 1 - solder bath, Sn96, 5Ag3Cu0.5 $T = 260 \pm 5 \text{ }^\circ\text{C}$ , $d = 10 \pm 1 \text{ s}$	$ \Delta V/V(1mA)  \leq 5\%$ No visible damage
Robustness of termination	Substrate bending test : IEC 60068-2-21, test Ue1 Deflection = 2 mm , $t = 60 \text{ s}$	$ \Delta V/V(1mA)  \leq 10\%$ No visible damage
	Shear test: IEC 60068-2-21, test Ue3 Force = 5 N , $t = 10 \pm 1 \text{ s}$	$ \Delta V/V(1mA)  \leq 10\%$ No visible damage
Vibration	IEC 60068-2-6, test Fc, method B4: Frequency range: 10 ... 55 Hz , Amplitude: 0.75 mm or 98 m/s <sup>2</sup> , Duration: 6 h (3 · 2 h) Pulse: sine wave After repeatedly applying a single harmonic vibration according to the table above. The change of $V_V$ shall be measured and the specimen shall be visually examined.	$ \Delta V/V(1mA)  \leq 5\%$ No visible damage
Bump	IEC 60068-2-27, test Ea: Pulse duration: 6 ms , Max. acceleration: 400 m/s <sup>2</sup> Number: 6 x 5000 shocks , Pulse shape: half sine	$ \Delta V/V(1mA)  \leq 5\%$ No visible damage
Fire hazard	IEC 60695-11-5 (needle flame test) Severity: vertical 10 s	5 s max.



**Soldering Parameters - Reflow Soldering (Surface Mount Devices)**

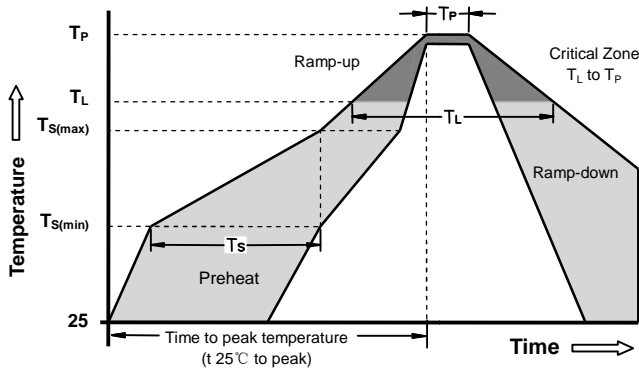

<b>Reflow Condition</b>		Pb - Free assembly
<b>Pre Heat at</b>	- Temperature Min ( $T_{s(min)}$ )	150°C
	- Temperature Max ( $T_{s(max)}$ )	200°C
	- Time (min to max) ( $t_s$ )	60 - 180 Seconds
<b>Average ramp up rate ( Liquids Temp <math>T_L</math> ) to peak</b>		3°C/second max
<b><math>T_{s(max)}</math> to <math>T_L</math> - Ramp-up Rate</b>		3°C/second max
<b>Reflow</b>	- Temperature ( $T_L$ ) (Liquids)	217°C
	- Time (min to max) ( $t_s$ )	60 - 150 Seconds
<b>Peak Temperature (<math>T_p</math>)</b>		260 +0/-5°C
<b>Time within 5°C of actual peak Temperature (<math>t_p</math>)</b>		20 - 40 Seconds
<b>Ramp-down Rate</b>		6°C/second max
<b>Time 25°C to peak Temperature (<math>T_s</math>)</b>		8 minutes Max
<b>Do not exceed</b>		260°C

**Precaution for soldering**

Note that this product will be easily damaged by rapid heating, rapid cooling or local heating.  
Do not give heat shock over 100°C in the process of soldering. We recommend to take preheating and gradual cooling

**Soldering gun procedure**

Note the follows, in case of using solder gun for replacement.  
1)The tip temperature must be less than 280 for the period within 3 seconds by using soldering gun under 30W  
2) The soldering gun tip shall not touch this product directly.

**Soldering volume**

Note that excess of soldering volume will easily get crack the body of this product.

**Dimensions And Recommended Pad Layout**

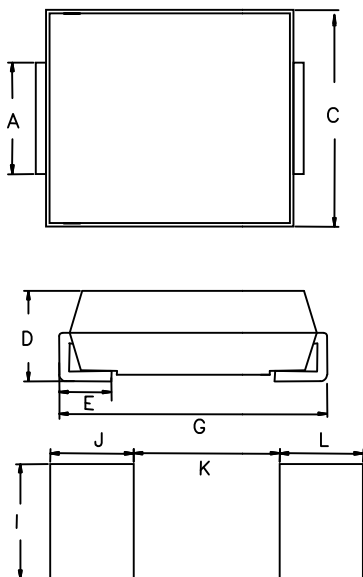

DIM	Millimeters	Inches
A	3.0±0.3	0.118±0.012
C	8.0±0.3	0.315±0.012
D	5.0±2.0	0.197±0.079
E	1.5±0.3	0.059±0.012
G	10.7±0.5	0.421±0.02
I	3.5	0.138
J	2.8	0.110
K	6.5	0.256
L	2.8	0.110



**Taping and Reel Specifications**

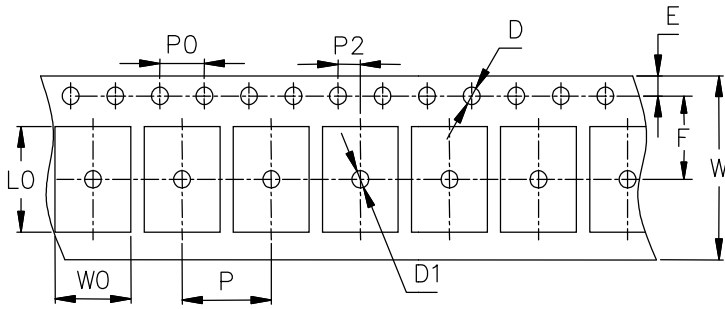

Symbol	Millimeters	Inches
W	16.00±0.30	0.630±0.012
E	1.75±0.10	0.069±0.004
F	7.50±0.10	0.295±0.004
D	1.55±0.05	0.061±0.002
D1	Φ1.50±0.10	Φ0.059±0.004
P	12.00±0.10	0.471±0.004
P0	4.00±0.10	0.157±0.004
P2	2.00±0.10	0.079±0.004

**Packing Specifications**

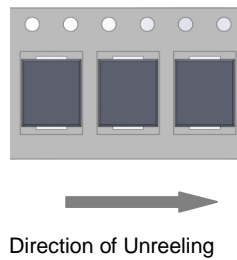
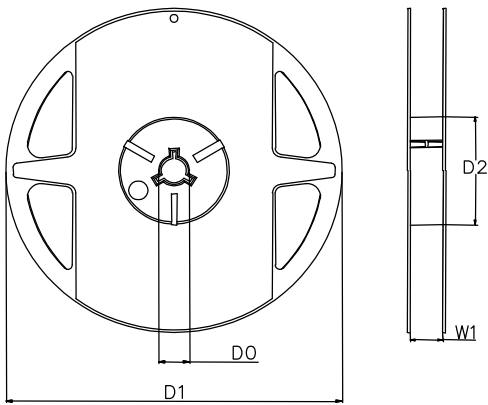

Symbol	Millimeters	Inches
D1	380+0/-2.0	14.961+0/-0.079
D2	Φ100.0±3.0	Φ3.937±0.118
W1	16.4±0.2	0.646±0.008

**Taping Specifications**

There shall be the portion having no product in both the head and the end of taping, and there shall be the cover tape in the heat of taping.

**Quantity of products in the taping package**

SIZE EIA (EIAJ)	4032
Standard Packing Quantity (PCS/reel)	1500



## X-ON Electronics

Largest Supplier of Electrical and Electronic Components

*Click to view similar products for [Varistors](#) category:*

*Click to view products by [Ruilongyuan](#) manufacturer:*

Other Similar products are found below :

[R71ZOV151HC](#) [B72205S271K111](#) [B72214S110K151](#) [B72214S251K151](#) [B72540E250K62](#) [NTE1V020](#) [NTE1V130](#) [25FN511K](#)  
[S10K11G5S5](#) [ERZ-C14DK361U](#) [ERZ-C20DK221U](#) [ERZ-C32CK201B](#) [207869-1](#) [AS-13](#) [B72214S200K551](#) [B72280B112K1](#) [B72540E](#)  
[350K 62](#) [B72590D360A60](#) [B72650M301K93](#) [B72670M1140K72](#) [TVZ18EC271KBS](#) [TVZ20EB911KBS](#) [TVZ25D201KBS](#) [TVZ25D241KBS](#)  
[VDRH20X230BSE](#) [VZ07D220KBS](#) [VZ40D241KQ-N](#) [VZ40D241K](#) [VZ25D511KBS-N](#) [VZ20E511KBSX](#) [VZ20E221KBSX](#)  
[VZ10D471KBS-N](#) [ERZ-V20R221](#) [20A9FN241K](#) [B72205S350K211](#) [B72214S110K551](#) [B72510E140K62](#) [B72650M350K72](#)  
[TVZ25DN271KBS](#) [TVZ25D301KBS](#) [TVZ20EC911KBS](#) [TVZ20EBN911KBS](#) [TVZ18EC471KBS](#) [B72220S350K101](#) [B72540E300K62](#)  
[TND10V-271KB00AAA0](#) [NTE1V030](#) [NTE1V275](#) [NTE2V015](#) [NTE2V035](#)