

ELECTRONICS

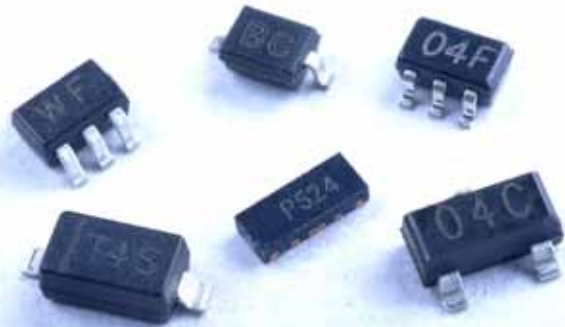

TVS/ESD Arrays

RLSD52AxxxC Series

TVS/ESD Arrays - RLSD52AxxxC Series

Features

- 200 Watts peak pulse power ($t_p = 8/20\mu s$)
- Transient protection for data lines to IEC 61000-4-2 (ESD) $\pm 30kV$ (air), $\pm 15kV$ (contact)
IEC 61000-4-4 (EFT) 40A ($t_p = 5/50ns$)
Cable Discharge Event (CDE)
- Ultra-small SOD-523 package (1.7 x 0.9 x 0.7mm)
- Protects one I/O or power line
- Low clamping voltage
- Working voltage
- Low leakage current
- Solid-state silicon-avalanche technology



Mechanical Characteristics

- SOD-523 package
- Molding compound flammability rating: UL 94V-0
- Packaging: Tape and Reel per EIA 481
- Lead Finish: Matte tin
- RoHS Compliant

Applications

- Switches / Buttons
- Test Equipment /Instrumentation
- Point-of-Sale Terminals
- Medical Equipment
- Notebooks / Desktops /Servers
- Computer Peripherals

Life Support Note

- Not Intended for Use in Life Support or Life Saving Applications
- The products shown herein are not designed for use in life sustaining or life saving applications unless otherwise expressly indicated

Pinout and Functional Block Diagram

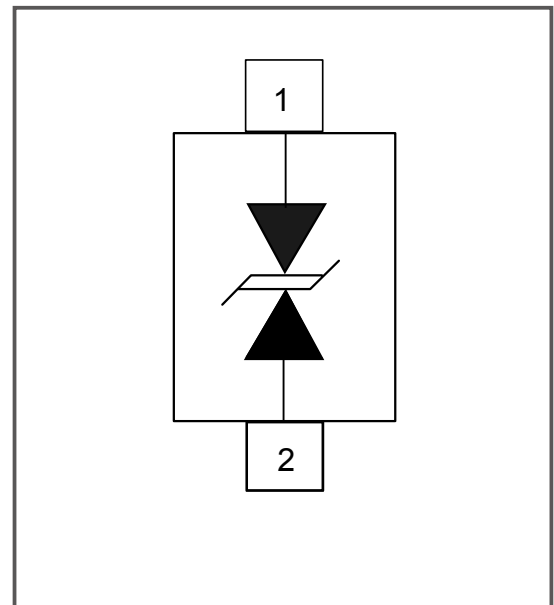

TVS/ESD Arrays - RLSD52AxxxC Series

Absolute Maximum Rating

Rating	Symbol	Value	Units
Peak Pulse Power (tp = 8/20μs)	Ppk	200	Watts
Maximum Peak Pulse Current (tp = 8/20μs)	IPP	8	Amps
ESD per IEC 61000-4-2 (Air)	VESD	±8	Kv
ESD per IEC 61000-4-2 (Contact)	VESD	±15	Kv
Lead Soldering Temperature	TL	260 (10 sec.)	°C
Operating Temperature	TJ	-55 to +125	°C
Storage Temperature	TSTG	-55 to +150	°C

Electrical Characteristics Per Lin (@ 25°C Unless Otherwise Specified)

Type Number	Peak Power Dissipation @8/20μS Pppm	Reverse Stand-Off Voltage	Peak Pulse Voltage @8/20μS	Peak Pulse Current @8/20μS	Reverse Leakage @Vrwm	Maximum Capacitance @1MHZ
		Vrwm	Vc@IPP	IPP	IR@Vrwm	Co
		Max			Max	Max
	W	V	V	A	μA	pF
RLSD52A051C	200	5	9.8	5	1	30
RLSD52A081C	200	8	15	5	1	35

TVS/ESD Arrays - RLSD52AxxxC Series

Typical Characteristics

Non-Repetitive Peak Pulse Power vs. Pulse Time

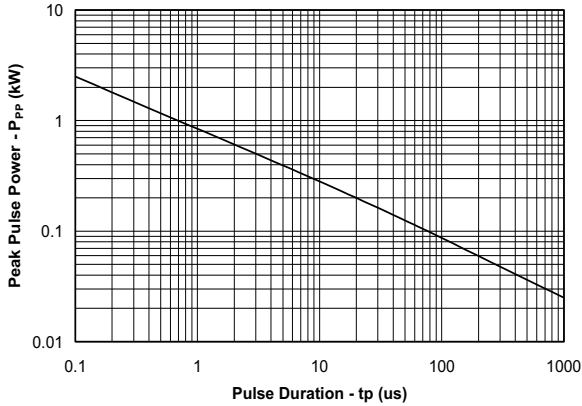

Power Derating Curve

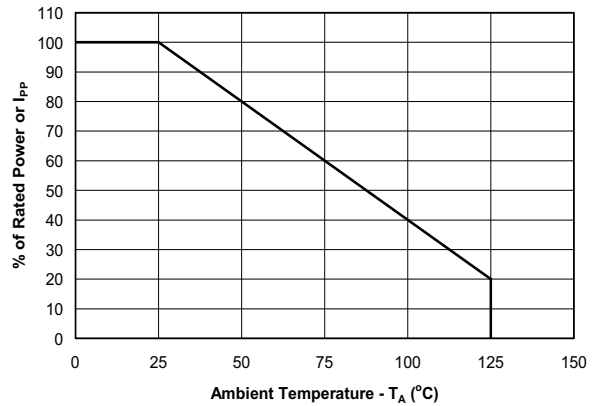

Clamping Voltage vs. Peak Pulse Current

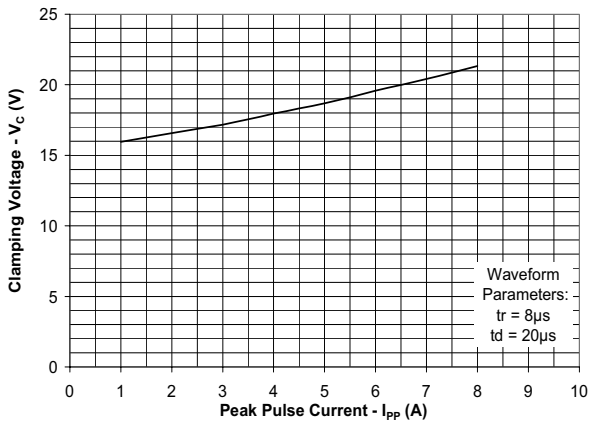

Forward Voltage vs. Forward Current

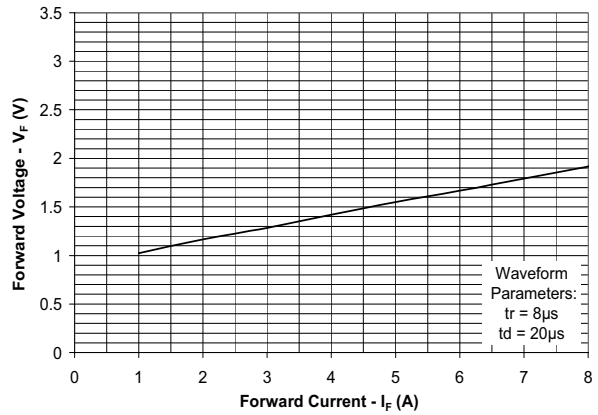

Junction Capacitance vs. Reverse Voltage

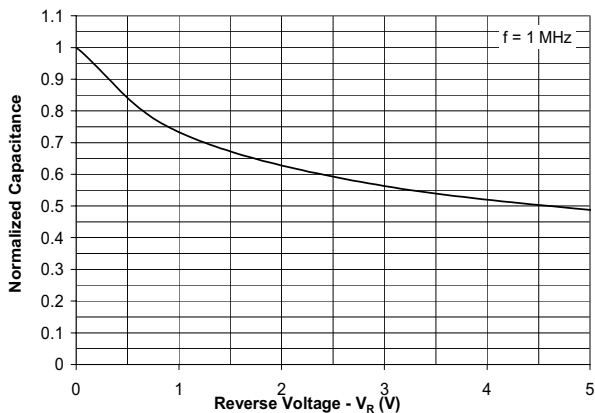

ESD Clamping (8kV Contact per IEC 61000-4-2)

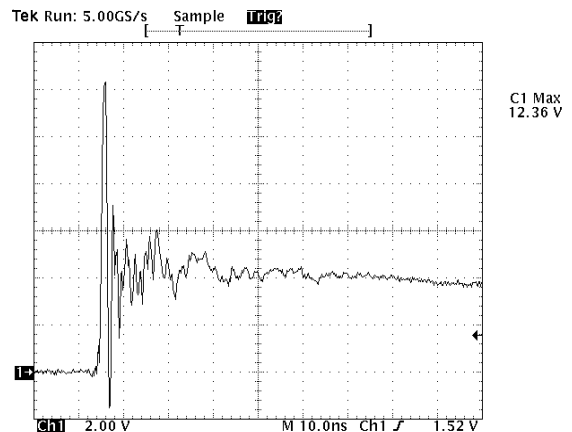

TVS/ESD Arrays - RLSD52AxxxC Series

Package dimension SOD-523

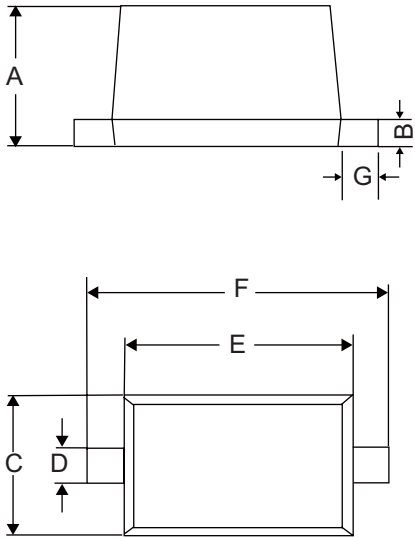

Dimensions						
Symbol	Inches			Millimeters		
	Min	Nom	Max	Min	Nom	Max
A	0.020	0.024	0.028	0.50	0.60	0.70
B	0.003	0.006	0.008	0.07	0.14	0.20
C	0.028	0.031	0.035	0.70	0.80	0.90
D	0.010	0.012	0.014	0.25	0.30	0.35
E	0.043	0.047	0.051	1.10	1.20	1.30
F	0.059	0.063	0.067	1.50	1.60	1.70
G	0.006	0.008	0.010	0.15	0.20	0.25

Recommended soldering footprint

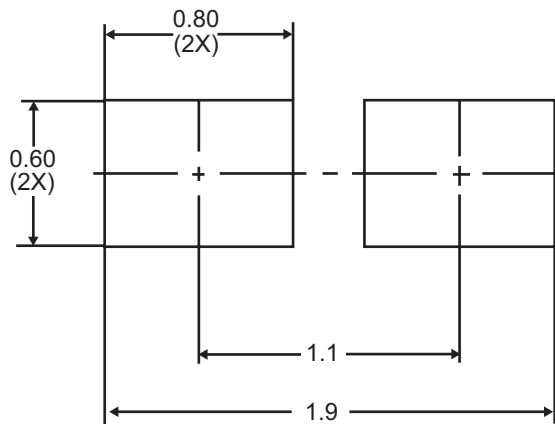

TVS/ESD Arrays - RLSD52AxxxC Series

Part Number Code

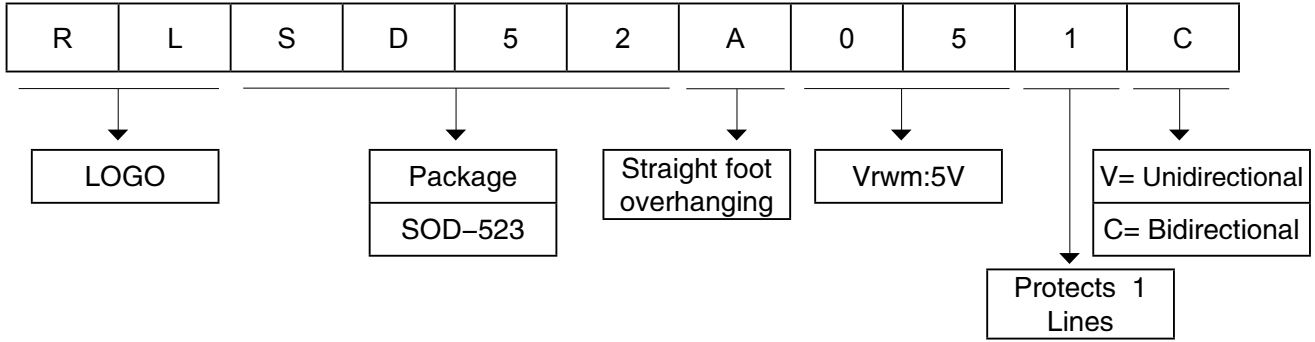

Tape and reel

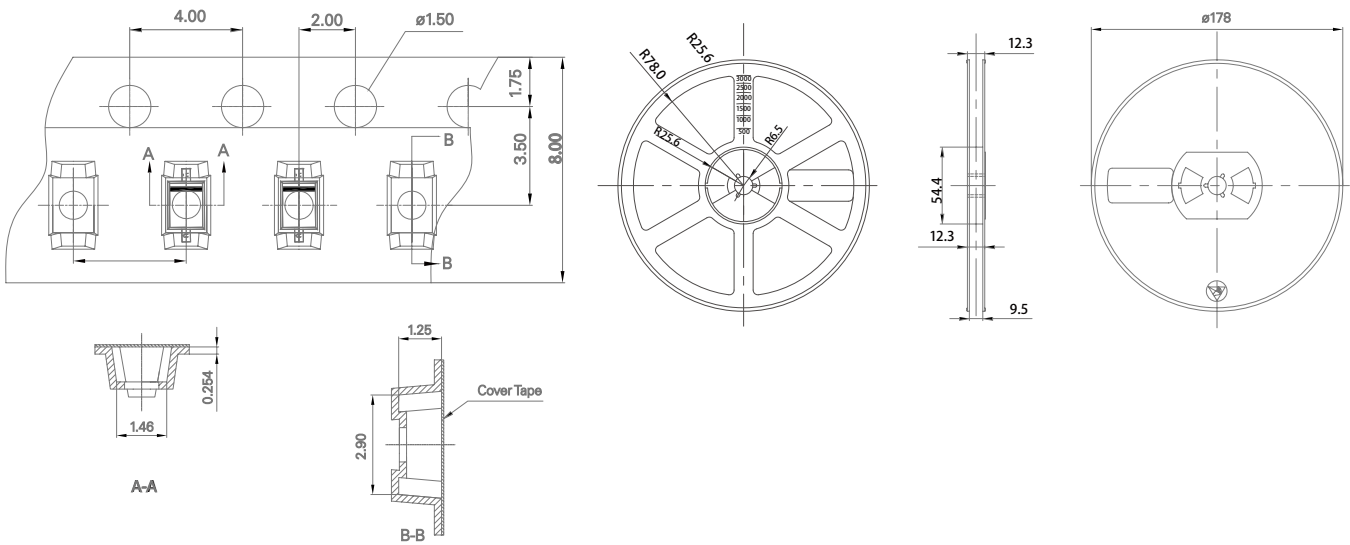

Ordering Information

Part Number	Package	Min. Order Qty.
RLSD52AxxxC	SOD-523	3000pcs

Warehouse Storage Conditions of Products

- Storage Conditions:

 1. Storage Temperature: -10°C~+40°C
 2. Relative Humidity: ≤75%RH
 3. Keep away from corrosive atmosphere and sunlight.
 4. Period of Storage: 1 year

RuiLongYuan Electronics Co., Ltd.

- Reproducing and modifying information of the document is prohibited without permission from Ruilongyuan International Inc.
 - Ruilongyuan International Inc. reserves the rights to make changes of the content herein the document anytime without notification. Please refer to our website for the latest document.
 - Ruilongyuan International Inc. disclaims any and all liability arising out of the application or use of any product including damages incidentally and consequentially occurred.
 - Ruilongyuan International Inc. does not assume any and all implied warranties, including warranties of fitness for particular purpose, non-infringement and merchantability.
 - Applications shown on the herein document are examples of standard use and operation. Customers are responsible in comprehending the suitable use in particular applications. Ruilongyuan International Inc. makes no representation or warranty that such applications will be suitable for the specified use without further testing or modification.
 - The products shown herein are not designed and authorized for equipments requiring high level of reliability or relating to human life and for any applications concerning life-saving or life-sustaining, such as medical instruments, transportation equipment, aerospace machinery et cetera. Customers using or selling these products for use in such applications do so at their own risk and agree to fully indemnify Ruilongyuan International Inc. for any damages resulting from such improper use or sale.
-

X-ON Electronics

Largest Supplier of Electrical and Electronic Components

Click to view similar products for [ESD Suppressors / TVS Diodes](#) category:

Click to view products by [Ruilongyuan](#) manufacturer:

Other Similar products are found below :

[60KS200C](#) [D18V0L1B2LP-7B](#) [D5V0F4U5P5-7](#) [DESD5V0U1BB-7](#) [NTE4902](#) [P4KE27CA](#) [P6KE11CA](#) [P6KE39CA-TP](#) [P6KE8.2A](#)
[SA110CA](#) [SA60CA](#) [SA64CA](#) [SMBJ12CATR](#) [SMBJ33CATR](#) [SMBJ8.0A](#) [ESD101-B1-02ELS E6327](#) [ESD105-B1-02EL E6327](#) [ESD112-B1-02EL E6327](#) [ESD119B1W01005E6327XTSA1](#) [ESD5V0L1B02VH6327XTSA1](#) [ESD7451N2T5G](#) [19180-510](#) [CPDT-5V0USP-HF](#)
[3.0SMCJ33CA-F](#) [3.0SMCJ36A-F](#) [HSPC16701B02TP](#) [D3V3Q1B2DLP3-7](#) [D55V0M1B2WS-7](#) [DESD5V0U1BL-7B](#) [DRTR5V0U4SL-7](#)
[SCM1293A-04SO](#) [ESD200-B1-CSP0201 E6327](#) [SM12-7](#) [SMF8.0A-TP](#) [SMLJ45CA-TP](#) [CEN955 W/DATA](#) [82350120560](#) [VESD12A1A-](#)
[HD1-GS08](#) [CPDUR5V0R-HF](#) [CPDQC5V0U-HF](#) [CPDQC5V0USP-HF](#) [CPDQC5V0-HF](#) [D1213A-01LP4-7B](#) [D1213A-02WL-7](#)
[MMAD1108/TR13](#) [5KP100A](#) [5KP15A](#) [5KP18A](#) [5KP48A](#) [5KP90A](#)