



TVS/ESD Arrays

RLST23AxxxC Series

TVS/ESD Arrays - RLST23AxxxC Series

Features

- 350 Watts peak pulse power ($t_p = 8/20\mu s$)
- Two devices protect two high-speed line pairs
- Low leakage current
- Low operating and clamping voltages
- Solid-state EPD TVS process technology
- Transient protection for high speed data lines to
IEC 61000-4-2 (ESD) $\pm 15kV$ (air), $\pm 8kV$ (contact)
IEC 61000-4-4 (EFT) 40A (5/50ns)
IEC 61000-4-5 (Lightning) 24A (8/20 μs)



Mechanical Characteristics

- JEDEC SOT-23 Package
- Molding Compound Flammability Rating : UL 94V-0
- Weight 8.0 Milligrams (Approximate)
- Quantity Per Reel : 3,000pcs
- Reel Size : 7 inch
- Lead Finish : Lead Free

Applications

- Cellular Handsets and Accessories
- Portable Electronics
- Industrial Controls
- Set-Top Box
- Servers, Notebook, and Desktop PC

Life Support Note

- Not Intended for Use in Life Support or Life Saving Applications
- The products shown herein are not designed for use in life sustaining or life saving applications unless otherwise expressly indicated

Pinout and Functional Block Diagram

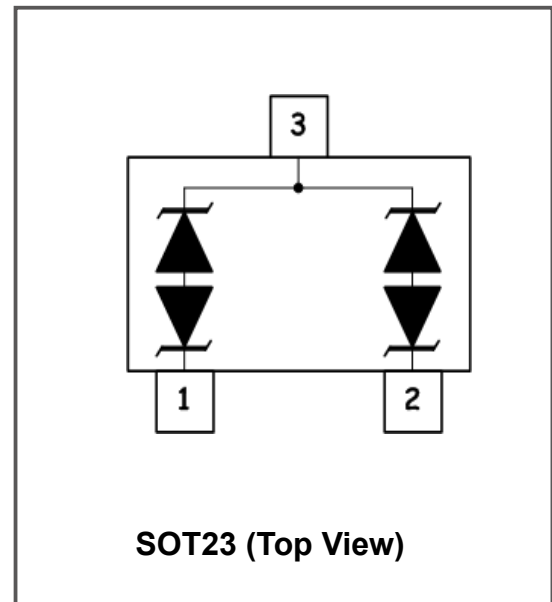

TVS/ESD Arrays - RLST23AxxxC Series

Absolute Maximum Rating

Rating	Symbol	Value	Units
Peak Pulse Power (tp =8/20μs)	Ppk	350	Watts
Lead Soldering Temperature	T _L	260 (10 sec.)	°C
Operating Temperature	T _J	-55 to +150	°C
Storage Temperature	T _{STG}	-55 to +150	°C

Electrical Characteristics Per Lin (@ 25°C Unless Otherwise Specified)

Type Number	Peak Power Dissipation @8/20μS Pppm	Reverse Stand-Off Voltage	Peak Pulse Voltage @8/20μS	Peak Pulse Current @8/20μS	Reverse Leakage @Vrwm	Maximum Capacitance @1MHZ
		Vrwm	Vc@IPP	IPP	IR@Vrwm	Co
		Max			Max	Max
	W	V	V	A	μA	pF
RLST23A032C	350	3.3	7	20	40	300
RLST23A052C	350	5	9.8	17	10	120
RLST23A082C	350	8	13.4	12	1	75
RLST23A122C	350	12	19	11	1	60
RLST23A152C	350	15	24	10	1	60
RLST23A182C	350	18	29	9	1	55
RLST23A242C	350	24	43	7	1	40
RLST23A362C	400	36	60	5	1	30

TVS/ESD Arrays - RLST23AxxxC Series

Typical Characteristics

Fig1. 8/20 μ s Pulse Waveform

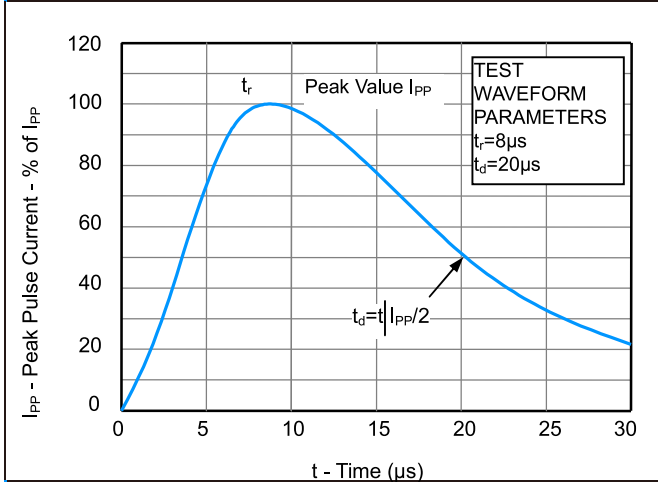

Fig2. ESD Pulse Waveform (according to IEC 61000-4-2)

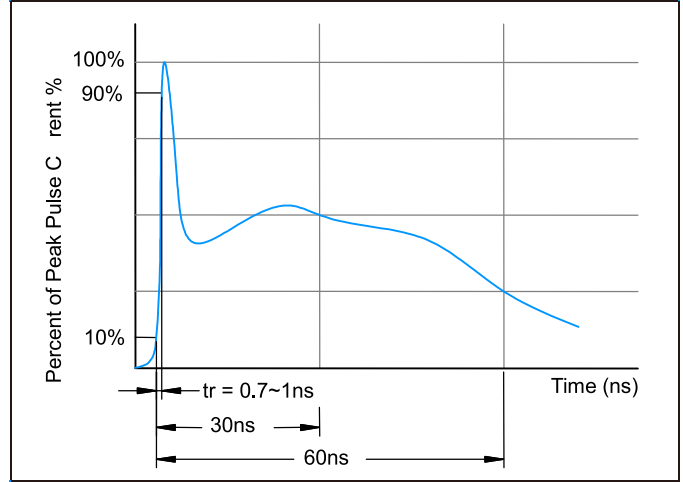

Fig3. ESD Clamping (+8KV Contac per IEC61000-4-2)

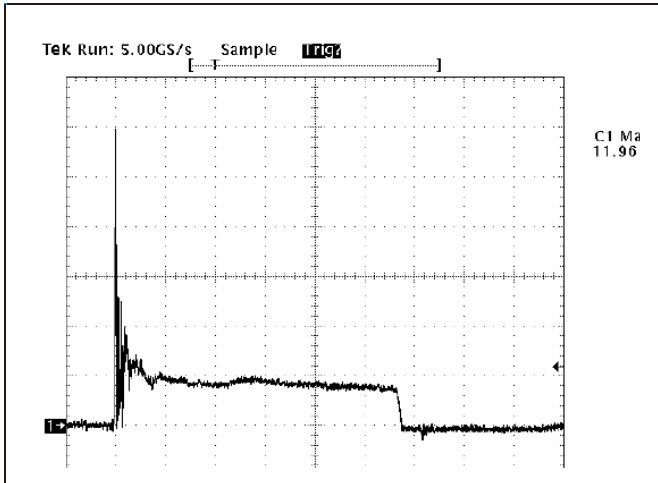
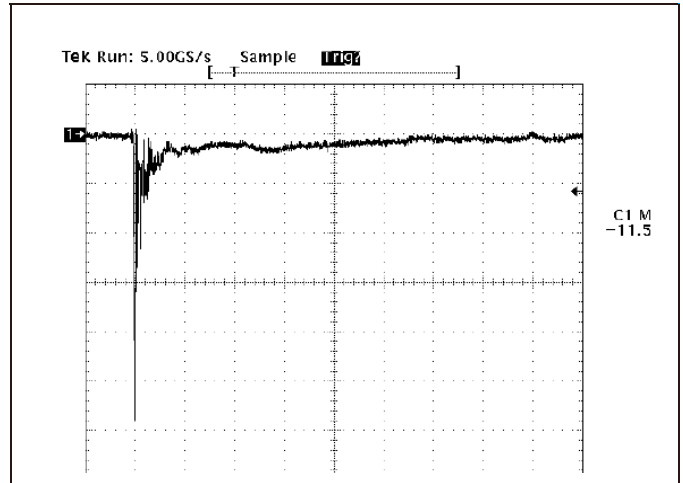
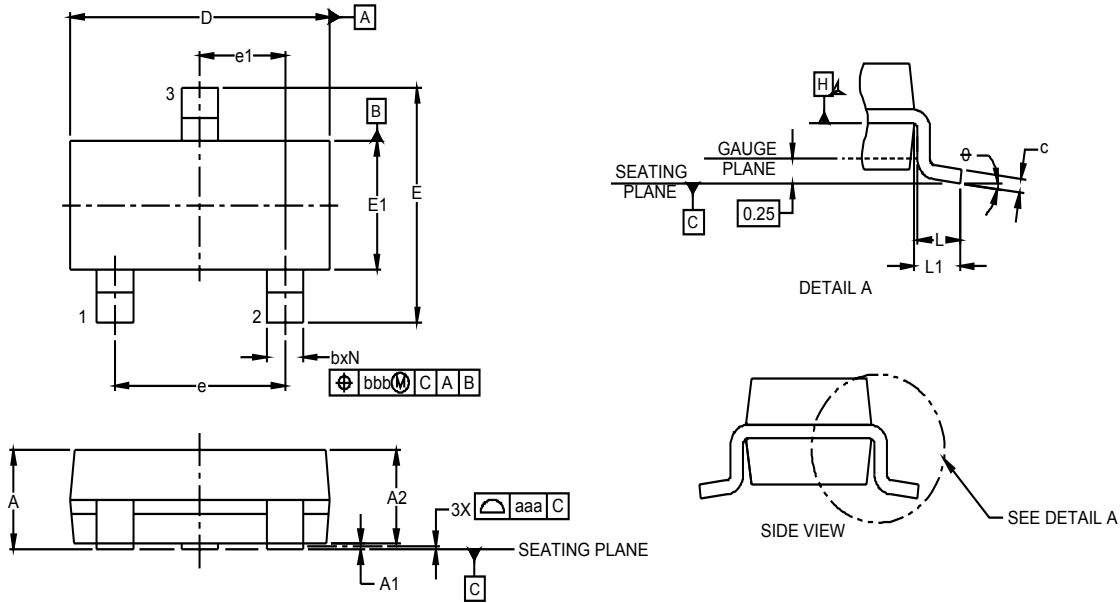

Fig4. ESD Clamping (-8KV Contac per IEC61000-4-2)



TVS/ESD Arrays - RLST23AxxxC Series

Package dimension SOT-23



DIM	Dimensions					
	Inches			Millimeters		
	Min	Nom	Max	Min	Nom	Max
A	.035	-	.044	0.89	-	1.12
A1	-	-	.004	0.01	-	0.10
A2	.035	.037	.040	0.01	-	0.10
b	.012	-	.020	0.30	-	0.51
c	.003	-	.007	0.08	-	0.18
D	.110	.114	.120	2.80	2.90	3.04
E	.082	.093	.104	2.10	2.37	2.64
E1	0.47	.051	.055	1.20	1.30	1.40
e		.075			1.90 BCS	
e1		.037			0.95 BCS	
L	.015	.020	.024	0.40	0.50	0.60
L1		.022			(0.55)	
N		3			3	

TVS/ESD Arrays - RLST23AxxxC Series

Recommended soldering footprint

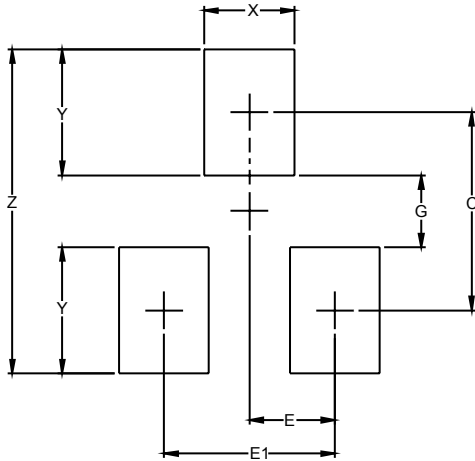

NOTES:

1. THIS LAND PATTERN IS FOR REFERENCE PURPOSES ONLY
CONSULT YOUR MANUFACTURING GROUP TO ENSURE YOUR
COMPANY'S MANUFACTURING GUIDELINES ARE MET.
2. REFERENCE IPC-SM-782A.

DIMENSIONS		
DIM	INCHES	MILLIMETERS
C	(.087)	(2.20)
E	.037	0.95
E1	.075	1.90
G	.031	0.80
X	.039	1.00
Y	.055	1.40
Z	.141	3.60

Part Number Code

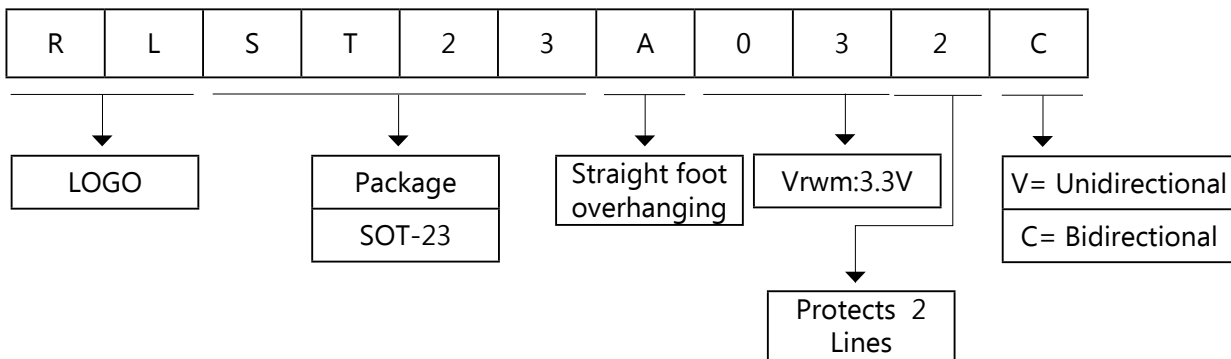

Ordering Information

Part Number	Package	Min. Order Qty.
RLST23AxxxC	SOT-23	3000pcs

RuiLongYuan Electronics Co., Ltd.

- Reproducing and modifying information of the document is prohibited without permission from Ruilongyuan International Inc.
- Ruilongyuan International Inc. reserves the rights to make changes of the content herein the document anytime without notification. Please refer to our website for the latest document.
- Ruilongyuan International Inc. disclaims any and all liability arising out of the application or use of any product including damages incidentally and consequentially occurred.
- Ruilongyuan International Inc. does not assume any and all implied warranties, including warranties of fitness for particular purpose, non-infringement and merchantability.
- Applications shown on the herein document are examples of standard use and operation. Customers are responsible in comprehending the suitable use in particular applications. Ruilongyuan International Inc. makes no representation or warranty that such applications will be suitable for the specified use without further testing or modification.
- The products shown herein are not designed and authorized for equipments requiring high level of reliability or relating to human life and for any applications concerning life-saving or life-sustaining, such as medical instruments, transportation equipment, aerospace machinery et cetera. Customers using or selling these products for use in such applications do so at their own risk and agree to fully indemnify Ruilongyuan International Inc. for any damages resulting from such improper use or sale.

Tel: +86-755-8290 8296

Fax: +86-755-8290 8002

E-mail: jack@ruilon.com

X-ON Electronics

Largest Supplier of Electrical and Electronic Components

Click to view similar products for [ESD Suppressors / TVS Diodes](#) category:

Click to view products by [Ruilongyuan](#) manufacturer:

Other Similar products are found below :

[60KS200C](#) [D18V0L1B2LP-7B](#) [D5V0F4U5P5-7](#) [DESD5V0U1BB-7](#) [NTE4902](#) [P4KE27CA](#) [P6KE11CA](#) [P6KE39CA-TP](#) [P6KE8.2A](#)
[SA110CA](#) [SA60CA](#) [SA64CA](#) [SMBJ12CATR](#) [SMBJ33CATR](#) [SMBJ8.0A](#) [ESD101-B1-02ELS E6327](#) [ESD105-B1-02EL E6327](#) [ESD112-B1-02EL E6327](#) [ESD119B1W01005E6327XTSA1](#) [ESD5V0L1B02VH6327XTSA1](#) [ESD7451N2T5G](#) [19180-510](#) [CPDT-5V0USP-HF](#)
[3.0SMCJ33CA-F](#) [3.0SMCJ36A-F](#) [HSPC16701B02TP](#) [D3V3Q1B2DLP3-7](#) [D55V0M1B2WS-7](#) [DESD5V0U1BL-7B](#) [DRTR5V0U4SL-7](#)
[SCM1293A-04SO](#) [ESD200-B1-CSP0201 E6327](#) [SM12-7](#) [SMF8.0A-TP](#) [SMLJ45CA-TP](#) [CEN955 W/DATA](#) [82350120560](#) [VESD12A1A-](#)
[HD1-GS08](#) [CPDUR5V0R-HF](#) [CPDQC5V0U-HF](#) [CPDQC5V0USP-HF](#) [CPDQC5V0-HF](#) [D1213A-01LP4-7B](#) [D1213A-02WL-7](#)
[MMAD1108/TR13](#) [5KP100A](#) [5KP15A](#) [5KP18A](#) [5KP48A](#) [5KP90A](#)