

Description

The SMCJ series is designed specifically to protect sensitive electronic equipment from voltage transients induced by lightning and other transient voltage events.

Features

- I Low profile package
- I Very fast response time
- I Halogen free and RoHS compliant
- I Low incremental surge resistance
- I Typical IR less than 1µA above 10V
- I For surface mounted applications to optimize board space
- I Compatible with industrial standard package DO-214AB
- I 1500W peak pulse power capability with at 10/1000µs waveform, repetition rate (duty cycle): 0.01%
- I High temperature soldering:260°C/ 10 seconds at terminals

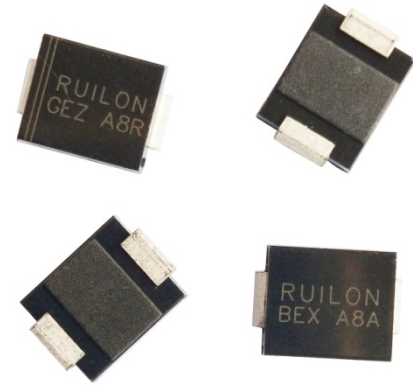

Electrical symbol

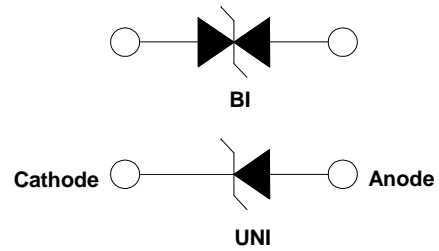

Part Number Code

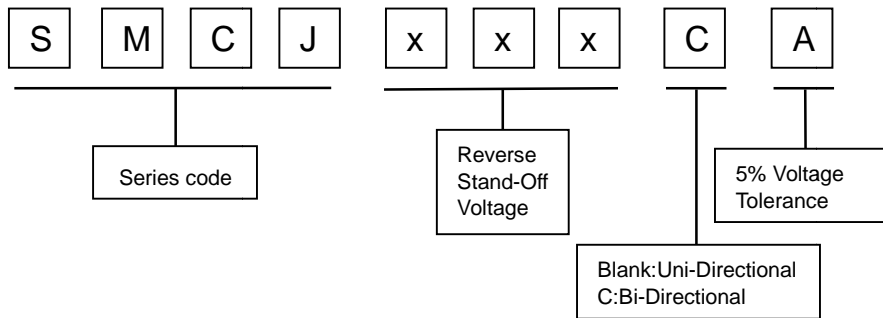

Mechanical Characteristics

Rating	Symbol	Value	Units
Peak Pulse Power Dissipation at T _A =25°C by 10/1000µs Waveform (Fig.2)(Note 1), (Note 2)	P _{PP}	1500	W
Power Dissipation on Infinite Heat Sink at T _L =75°C(Fig.6)	P _D	5.0	W
Peak Forward Surge Current, 8.3ms Single Half Sine Wave (Note 3)	I _{FSM}	200	A
Operating Temperature Range	T _J	-55 to 150	°C
Storage Temperature Range	T _{STG}	-55 to 150	°C

Notes:

1. Non-repetitive current pulse , per Fig. 4 and derated above T_A = 25°C per Fig. 3.
2. Mounted on copper pad area of 0.31x0.31" (8.0 x 8.0mm) to each terminal.
3. Measured on 8.3ms single half sine wave or equivalent square wave for unidirectional device only, duty cycle=4 per minute maximum.



Electrical Characteristics

Type Number		Marking		Reverse Stand-Off Voltage	Breakdown Voltage		Test Current	Max. Clamping Voltage 10/1000µs	Max. Peak Pulse Current 10/1000µs	Reverse Leakage
					V _{BR} @I _T					
				UNI	BI	UNI	BI	V _{RWM}	Min	Max
				V	V	V	mA	V	A	µA
SMCJ5.0A	SMCJ5.0CA	GDE	BDE	5.0	6.40	7.07	10	9.2	163.0	500
SMCJ6.0A	SMCJ6.0CA	GDG	BDG	6.0	6.67	7.37	10	10.3	145.6	500
SMCJ6.5A	SMCJ6.5CA	GDK	BDK	6.5	7.22	7.98	10	11.2	133.9	300
SMCJ7.0A	SMCJ7.0CA	GDM	BDM	7.0	7.78	8.60	10	12.0	125.0	200
SMCJ7.5A	SMCJ7.5CA	GDP	BDP	7.5	8.33	9.21	1	12.9	116.3	100
SMCJ8.0A	SMCJ8.0CA	GDR	BDR	8.0	8.89	9.83	1	13.6	110.3	50
SMCJ8.5A	SMCJ8.5CA	GDT	BDT	8.5	9.44	10.4	1	14.4	104.2	30
SMCJ9.0A	SMCJ9.0CA	GDV	BDV	9.0	10.0	11.1	1	15.4	97.4	30
SMCJ10A	SMCJ10CA	GDX	BDX	10.0	11.1	12.3	1	17.0	88.2	5
SMCJ11A	SMCJ11CA	GDZ	BDZ	11.0	12.2	13.5	1	18.2	82.4	1
SMCJ12A	SMCJ12CA	GEE	BEE	12.0	13.3	14.7	1	19.9	75.4	1
SMCJ13A	SMCJ13CA	GEG	BEG	13.0	14.4	15.9	1	21.5	69.8	1
SMCJ14A	SMCJ14CA	GEK	BEK	14.0	15.6	17.2	1	23.2	64.7	1
SMCJ15A	SMCJ15CA	GEM	BEM	15.0	16.7	18.5	1	24.4	61.5	1
SMCJ16A	SMCJ16CA	GEP	BEP	16.0	17.8	19.7	1	26.0	57.7	1
SMCJ17A	SMCJ17CA	GER	BER	17.0	18.9	20.9	1	27.6	54.3	1
SMCJ18A	SMCJ18CA	GET	BET	18.0	20.0	22.1	1	29.2	51.4	1
SMCJ20A	SMCJ20CA	GEV	BEV	20.0	22.2	24.5	1	32.4	46.3	1
SMCJ22A	SMCJ22CA	GEX	BEX	22.0	24.4	26.9	1	35.5	42.3	1
SMCJ24A	SMCJ24CA	GEZ	BEZ	24.0	26.7	29.5	1	38.9	38.6	1
SMCJ26A	SMCJ26CA	GFE	BFE	26.0	28.9	31.9	1	42.1	35.6	1
SMCJ28A	SMCJ28CA	GFG	BFG	28.0	31.1	34.4	1	45.4	33.0	1
SMCJ30A	SMCJ30CA	GFK	BFK	30.0	33.3	36.8	1	48.4	31.0	1
SMCJ33A	SMCJ33CA	GFM	BFM	33.0	36.7	40.6	1	53.3	28.1	1
SMCJ36A	SMCJ36CA	GFP	BFP	36.0	40.0	44.2	1	58.1	25.8	1
SMCJ40A	SMCJ40CA	GFR	BFR	40.0	44.4	49.1	1	64.5	23.3	1
SMCJ43A	SMCJ43CA	GFT	BFT	43.0	47.8	52.8	1	69.4	21.6	1
SMCJ45A	SMCJ45CA	GFV	BFV	45.0	50.0	55.3	1	72.7	20.6	1
SMCJ48A	SMCJ48CA	GJT	BJT	48.0	53.3	58.9	1	77.4	19.4	1
SMCJ51A	SMCJ51CA	GJV	BJV	51.0	56.7	62.7	1	82.4	18.2	1



Electrical Characteristics

Type Number		Marking		Reverse Stand-Off Voltage	Breakdown Voltage		Test Current	Max. Clamping Voltage 10/1000 μ s	Max. Peak Pulse Current 10/1000 μ s	Reverse Leakage
					$V_{BR} @ I_T$					
				UNI	BI	UNI	BI	V_{RWM}	Min	Max
				V	V	V	mA	V	A	μ A
SMCJ54A	SMCJ54CA	GFX	BFX	54.0	60.0	66.3	1	87.1	17.2	1
SMCJ58A	SMCJ58CA	GFZ	BFZ	58.0	64.4	71.2	1	93.6	16.0	1
SMCJ60A	SMCJ60CA	GGE	BGE	60.0	66.7	73.7	1	96.8	15.5	1
SMCJ64A	SMCJ64CA	GGG	BGG	64.0	71.1	78.6	1	103.0	14.6	1
SMCJ70A	SMCJ70CA	GGK	BGK	70.0	77.8	86.0	1	113.0	13.3	1
SMCJ75A	SMCJ75CA	GGM	BGM	75.0	83.3	92.1	1	121.0	12.4	1
SMCJ78A	SMCJ78CA	GGP	BGP	78.0	86.7	95.8	1	126.0	11.9	1
SMCJ85A	SMCJ85CA	GGR	BGR	85.0	94.4	104.0	1	137.0	10.9	1
SMCJ90A	SMCJ90CA	GGT	BGT	90.0	100.0	111.0	1	146.0	10.3	1
SMCJ100A	SMCJ100CA	GGV	BGV	100.0	111.0	123.0	1	162.0	9.3	1
SMCJ110A	SMCJ110CA	GGX	BGX	110.0	122.0	135.0	1	177.0	8.5	1
SMCJ120A	SMCJ120CA	GGZ	BGZ	120.0	133.0	147.0	1	193.0	7.8	1
SMCJ130A	SMCJ130CA	GHE	BHE	130.0	144.0	159.0	1	209.0	7.2	1
SMCJ150A	SMCJ150CA	GHG	BHG	150.0	167.0	185.0	1	243.0	6.2	1
SMCJ160A	SMCJ160CA	GHK	BHK	160.0	178.0	197.0	1	259.0	5.8	1
SMCJ170A	SMCJ170CA	GHM	BHM	170.0	189.0	209.0	1	275.0	5.5	1
SMCJ180A	SMCJ180CA	GHP	BHP	180.0	201.0	222.0	1	292.0	5.2	1
SMCJ190A	SMCJ190CA	GHR	BHR	190.0	209.0	243.0	1	308.0	4.8	1
SMCJ200A	SMCJ200CA	GHX	BHX	200.0	224.0	247.0	1	324.0	4.6	1
SMCJ210A	SMCJ210CA	GHZ	BHZ	210.0	231.0	268.0	1	340.0	4.4	1
SMCJ220A	SMCJ220CA	GJE	BJE	220.0	246.0	272.0	1	356.0	4.2	1
SMCJ250A	SMCJ250CA	GJG	BJG	250.0	279.0	309.0	1	405.0	3.7	1
SMCJ300A	SMCJ300CA	GJK	BJK	300.0	335.0	371.0	1	486.0	3.1	1
SMCJ350A	SMCJ350CA	GJM	BJM	350.0	391.0	432.0	1	567.0	2.6	1
SMCJ400A	SMCJ400CA	GJP	BJP	400.0	447.0	494.0	1	648.0	2.3	1
SMCJ440A	SMCJ440CA	GJR	BJR	440.0	492.0	543.0	1	713.0	2.1	1

Notes: For bidirectional type having V_R of 10V and less, the I_R limit is double.

I-V Curve Characteristics

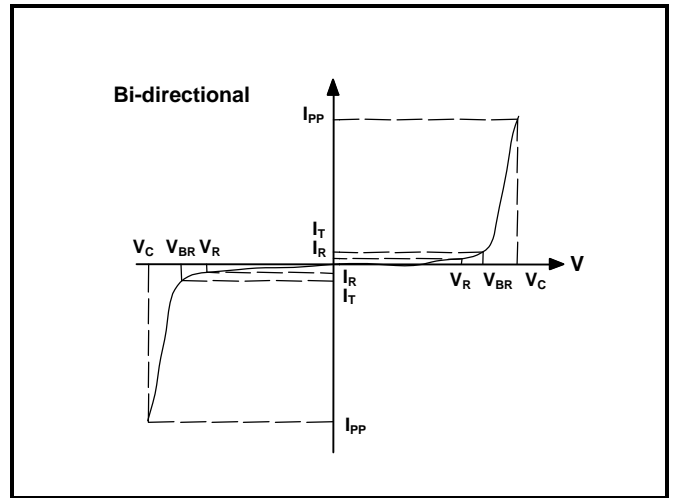
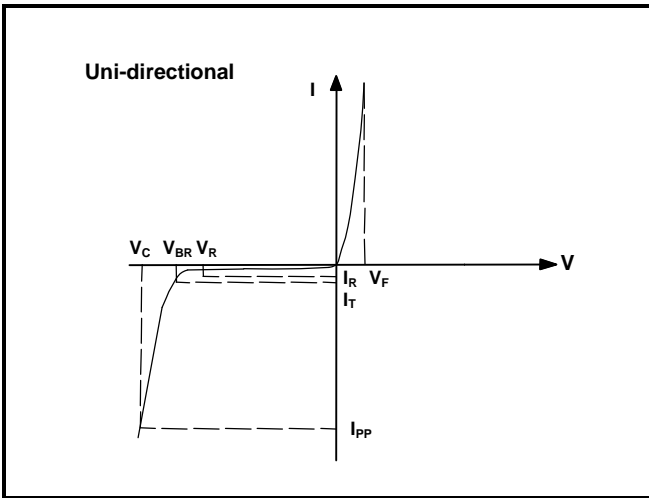

P_{PPM} Peak Pulse Power Dissipation -- Max power dissipation

V_R Stand-off Voltage -- Maximum voltage that can be applied to the TVS without operation

V_{BR} Breakdown Voltage -- Maximum voltage that flows though the TVS at a specified test current (I_T)

V_C Clamping Voltage -- Peak voltage measured across the TVS at a specified I_{ppm} (peak impulse current)

I_R Reverse Leakage Current -- Current measured at V_R

V_F Forward Voltage Drop for Uni-directional

Ratings and Characteristic Curves ($T_A=25^\circ\text{C}$ unless otherwise noted)

Figure 1 - TVS Transients Clamping Waveform

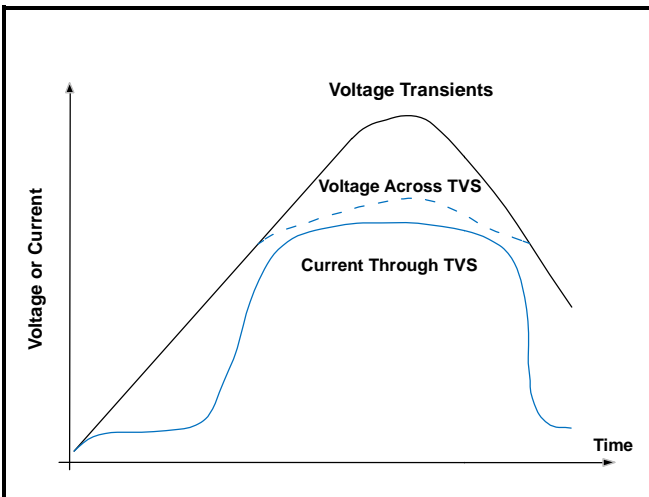
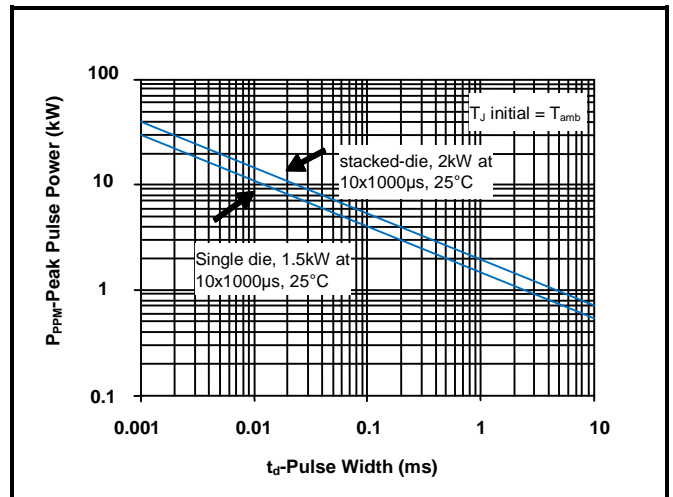

Figure 2 - Peak Pulse Power Rating Curve



Ratings and Characteristic Curves ($T_A=25^\circ\text{C}$ unless otherwise noted) (Continued)

Figure 3 - Pulse Derating Curve

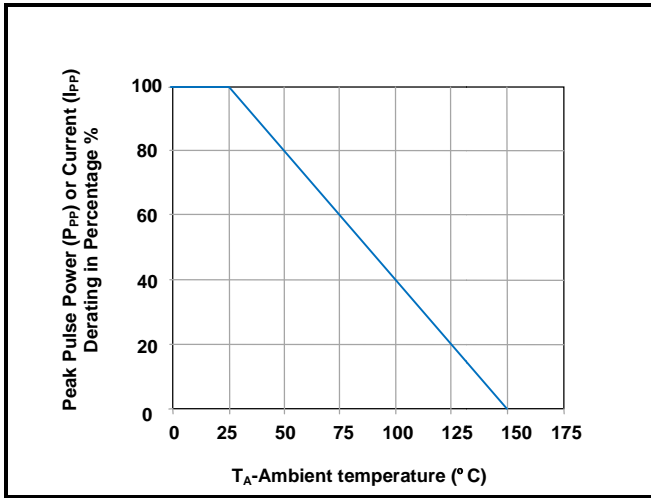

Figure 4 - Pulse Waveform

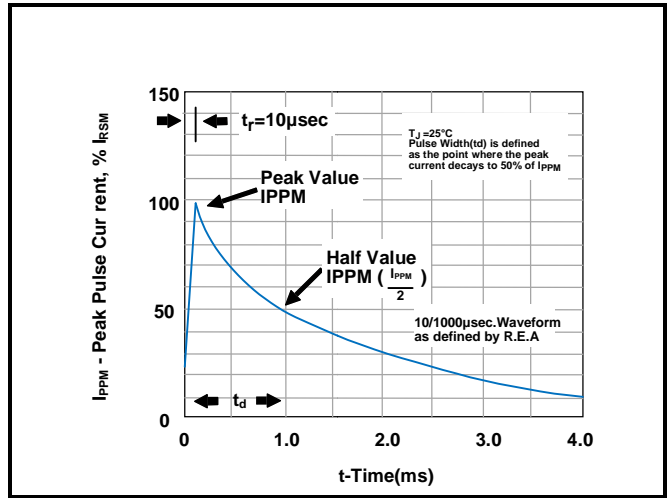

Figure 5 - Typical Junction Capacitance

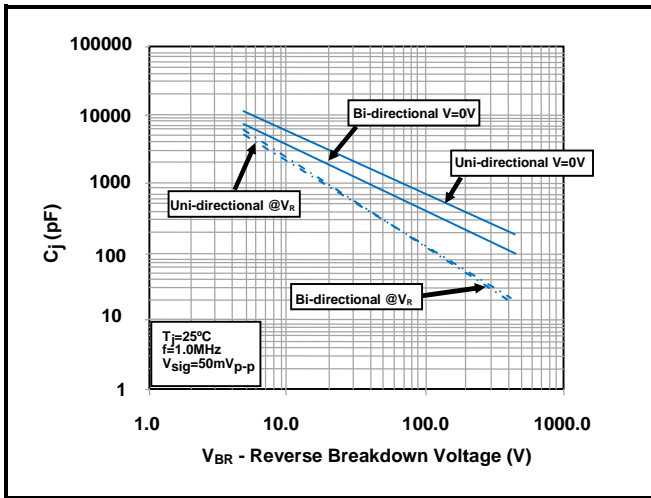

Figure 6 - Steady State Power Derating Curve

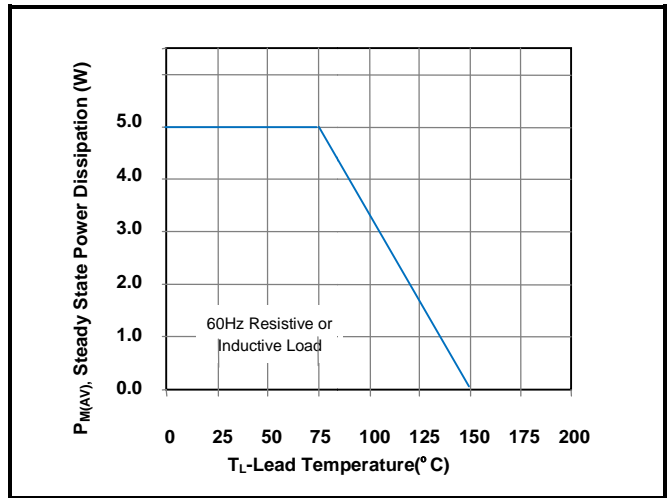
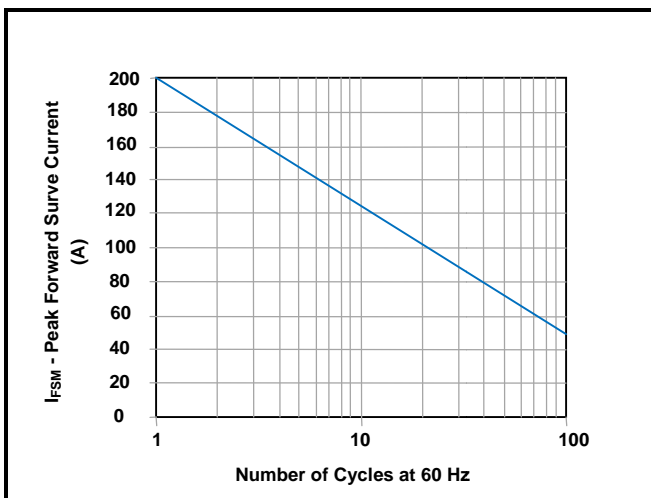
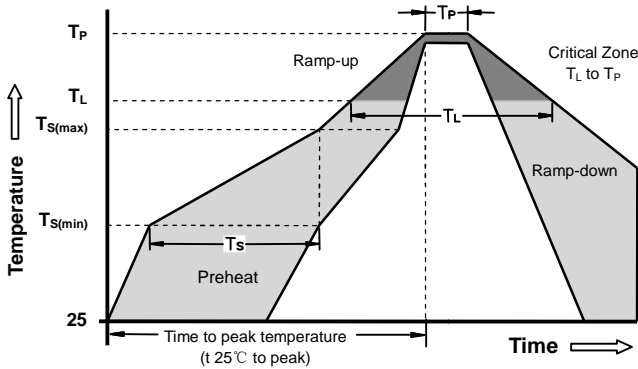

Figure 7 - Maximum Non-Repetitive Surge Current



Soldering Parameters - Reflow Soldering (Surface Mount Devices)



Reflow Condition		Pb - Free assembly
Pre Heat	-Temperature Min ($T_{s(min)}$)	150°C
	-Temperature Max ($T_{s(max)}$)	200°C
	- Time (min to max) (t_s)	60 -180 Seconds
Average ramp up rate (Liquids Temp T_L) to peak		3°C/second max
$T_{s(max)}$ to T_L - Ramp-up Rate		3°C/second max
Reflow	- Temperature (T_L) (Liquids)	217°C
	- Time (min to max) (t_s)	60 -150 Seconds
Peak Temperature (T_P)		260 +0/-5°C
Time within 5°C of actual peak Temperature (t_p)		20 - 40 Seconds
Ramp-down Rate		6°C/second max
Time 25°C to peak Temperature (T_P)		8 minutes Max
Do not exceed		260°C

Part Marking System

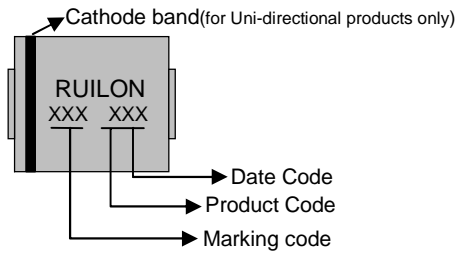

Dimensions

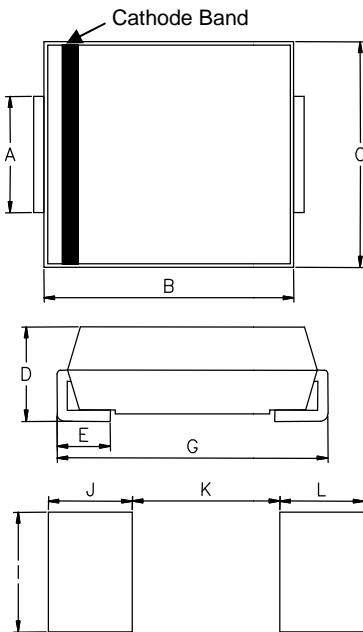

DIM	Millimeters		Inches	
	Min	Max	Min	Max
A	2.75	3.25	0.108	0.128
B	6.50	7.11	0.260	0.280
C	5.50	6.22	0.217	0.246
D	2.06	2.70	0.079	0.106
E	0.76	1.52	0.030	0.060
G	7.40	8.40	0.291	0.331
I	3.300	-	0.129	-
J	2.400	-	0.094	-
K	-	4.200	-	0.165
L	2.400	-	0.094	-



Taping and Reel Specifications

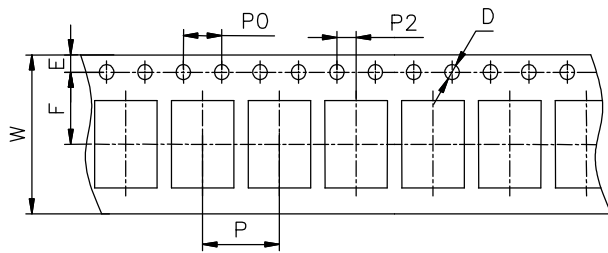

Symbol	Millimeters	Inches
W	16±0.3	0.630±0.012
P	8±0.1	0.315±0.004
F	7.25±0.1	0.285±0.004
E	1.75±0.1	0.069±0.004
D	1.5+0.1/-0.0	0.059+0.004/-0.0
P0	4±0.1	0.157±0.004
P2	2±0.1	0.079±0.004
D0	16.7±0.15	0.657±0.006
D1	178±2	7.007±0.079
D2	59.6+1/-2	2.346+0.039/-0.079
W1	17.2±0.4	0.677±0.016

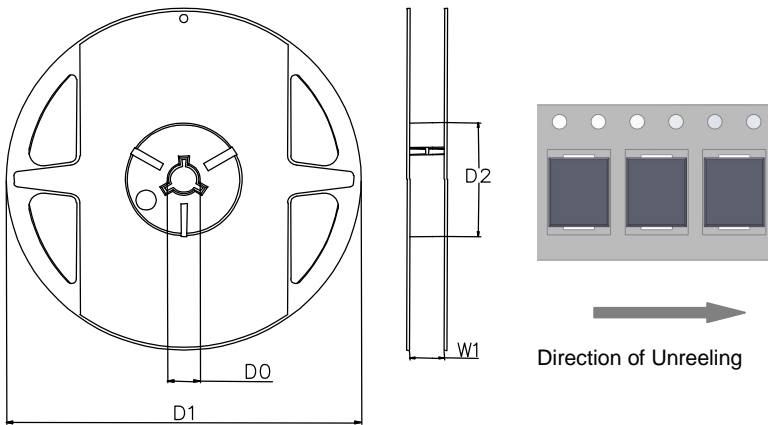

Part Number	Component package	Quantity	Packaging option	Packaging specification
SMCJXXXA/CA	DO-214AB(SMC)	500	Tape&Reel-16mm/7"tape	EIA STD RS-481



X-ON Electronics

Largest Supplier of Electrical and Electronic Components

Click to view similar products for [ESD Suppressors / TVS Diodes](#) category:

Click to view products by [Ruilongyuan](#) manufacturer:

Other Similar products are found below :

[60KS200C](#) [D18V0L1B2LP-7B](#) [D5V0F4U5P5-7](#) [NTE4902](#) [P4KE27CA](#) [P6KE11CA](#) [P6KE8.2A](#) [SA60CA](#) [SA64CA](#) [SMBJ12CATR](#)
[SMBJ33CATR](#) [SMBJ6.5A](#) [SMBJ8.0A](#) [ESD101-B1-02ELS E6327](#) [ESD112-B1-02EL E6327](#) [ESD7451N2T5G](#) [19180-510](#) [CPDT-5V0USP-](#)
[HF](#) [3.0SMCJ33CA-F](#) [3.0SMCJ36A-F](#) [HSPC16701B02TP](#) [JANTX1N6126A](#) [D3V3Q1B2DLP3-7](#) [D55V0M1B2WS-7](#) [SCM1293A-04SO](#)
[ESD200-B1-CSP0201 E6327](#) [SM12-7](#) [CEN955 W/DATA](#) [VESD12A1A-HD1-GS08](#) [CPDQC5V0-HF](#) [D1213A-01LP4-7B](#) [ESD101-B1-02EL](#)
[E6327](#) [AOZ8808DI-03](#) [5KP15A](#) [5KP48A](#) [5KP90A](#) [ESD3V3D7-TP](#) [15KPA36A-LF](#) [P4KE56CA](#) [P4KE68A](#) [P4KE91CATR](#) [P6KE120A](#)
[P6KE13CA](#) [P6KE43CA](#) [P6KE6.8CA](#) [P6KE8.2](#) [P6SMBJ20CA](#) [JANTX1N6072A](#) [SR2835ESKG](#) [SA90CA](#)