

# 14-Bit, 2 MSPS, Dual-Channel, Single-Ended Analog-to-Digital Converters

## 1 FEATURES

- **Sample Rate: 2 MSPS**
- **INL 2.5 LSB (MAX)**
- **Wide Supply Range:**  
**Analog: 2.7 V to 5.25 V**  
**Digital: 1.65 V to AVDD**
- **14-Bit No Missing Code Resolution**
- **Auto Power-Down at Lower Speeds**
- **Two Single-Ended Inputs**
- **Operating Temperature Range -40 °C to 125 °C**
- **SPI-Compatible Interface**
- **Package: QFN3x3-16**

## 2 APPLICATIONS

- **Optical networking**
- **Sensors Measurements**
- **Portable Instrumentation**
- **Medical Instrumentation**
- **Data Acquisition Systems**
- **Battery-Powered Equipment**

## 3 DESCRIPTIONS

The RS1473 is a 14-bit, 2MSPS analog-to-digital converter (ADC) that offers Single-Ended inputs. The device operates at a 2MSPS sample rate with a standard 16 clock data frame. The device includes a two-channel input multiplexer and a low-power successive approximation register (SAR) ADC with an inherent sample-and-hold (S/H) input stage.

The RS1473 supports a wide analog supply range that allows the full-scale input range to extend to 5 V single-ended. A simple SPI, with a digital supply that can operate as low as 1.65 V, allows for easy interfacing to a wide variety of digital controllers. Automatic power-down can be enabled when operating at slower speeds to dramatically reduce power consumption.

The RS1473 is offered in a leadless QFN3x3-16 package and is specified over a temperature range of -40°C to +125°C.

**Device Information<sup>(1)</sup>**

PART NUMBER	PACKAGE	BODY SIZE(NOM)
RS1473	QFN3x3-16	3.00mm x 3.00mm

(1) For all available packages, see the orderable addendum at the end of the data sheet.

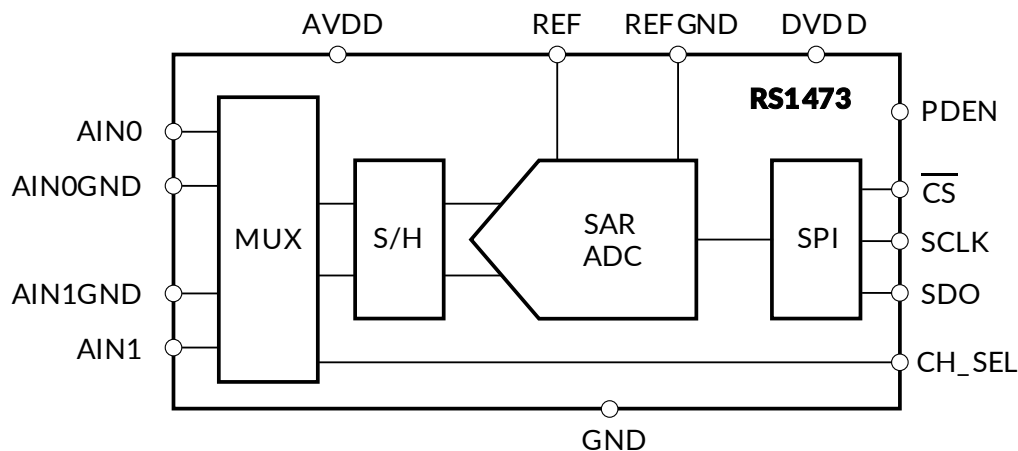

**Figure 1. Block Diagram**

## Table of Contents

<b>1 FEATURES</b> .....	1
<b>2 APPLICATIONS</b> .....	1
<b>3 DESCRIPTIONS</b> .....	1
<b>4 Revision History</b> .....	3
<b>5 PACKAGE/ORDERING INFORMATION</b> <sup>(1)</sup> .....	4
<b>6 Pin Configuration and Functions (Top View)</b> .....	5
<b>7 SPECIFICATIONS</b> .....	6
7.1 Absolute Maximum Ratings .....	6
7.2 ESD Ratings .....	6
7.3 Recommended Operating Conditions .....	6
7.4 ELECTRICAL CHARACTERISTICS .....	7
7.5 Timing DIAGRAM:RS1473 .....	9
7.6 TYPICAL CHARACTERISTICS .....	10
<b>8 OVERVIEW</b> .....	18
8.1 MULTIPLEXER AND ADC INPUT .....	18
8.2 REFERENCE .....	19
8.3 ADC TRANSFER FUNCTION .....	20
<b>9 DEVICE OPERATION</b> .....	21
9.1 16-CLOCK FRAME .....	21
9.2 32-CLOCK FRAME .....	21
9.3 CONVERSION ABORT .....	22
9.4 POWER-DOWN .....	22
9.5 APPLICATION INFORMATION .....	23
9.6 DRIVING AN ADC WITHOUT A DRIVING OP AMP .....	24
<b>10 PACKAGE OUTLINE DIMENSIONS</b> .....	26
<b>11 TAPE AND REEL INFORMATION</b> .....	27

## 4 Revision History

Note: Page numbers for previous revisions may differ from page numbers in the current version.

VERSION	Change Date	Change Item
A.0	2023/05/05	Preliminary version completed
A.1	2024/01/31	Initial version completed

**5 PACKAGE/ORDERING INFORMATION <sup>(1)</sup>**

Orderable Device	Package Type	Pin	Channel	Op Temp(°C)	Device Marking <sup>(2)</sup>	MSL <sup>(3)</sup>	Package Qty
RS1473XTQC16	QFN3x3-16	16	2-Single-Ended	-40°C ~125°C	RS1473	MSL3	Tape and Reel,5000

## NOTE:

- (1) This information is the most current data available for the designated devices. This data is subject to change without notice and revision of this document. For browser-based versions of this data sheet, refer to the right-hand navigation.
- (2) There may be additional marking, which relates to the lot trace code information (data code and vendor code), the logo or the environmental category on the device.
- (3) MSL, The Moisture Sensitivity Level rating according to the JEDEC industry standard classifications.

## 6 Pin Configuration and Functions (Top View)

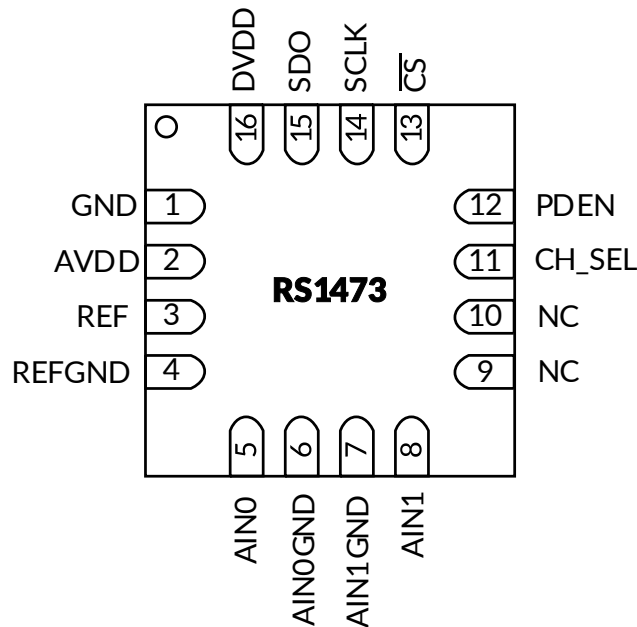

**Figure 2. QFN3x3-16**

**Table 1. PIN FUNCTIONS**

PIN	NAME	DESCRIPTION
1	GND	Power supply ground
2	AVDD	ADC power supply
3	REF	ADC positive reference input, decouple this pin with REFGND
4	REFGND	Reference return; short to analog ground plane
5	AIN0	Positive analog input, channel 0
6	AIN0GND	Ground sense analog input, channel 0
7	AIN1GND	Ground sense analog input, channel1
8	AIN1	Positive analog input, channel1
9	NC	Not connected internally, recommended to short this pin to GND
10	NC	Not connected internally, recommended to short this pin to GND
11	CH_SEL	Selects the analog input channel. Low = Channel 0 High = Channel 1 Recommended to change the channel within a window of one clock, from half a clock after the $\overline{CS}$ falling edge. This change ensures the settling on the multiplexer output before the sample start.
12	PDEN	Enables a power down feature if it is high at the $\overline{CS}$ rising edge
13	$\overline{CS}$	Chip select signal, active low
14	SCLK	Serial SPI clock
15	SDO	Serial data out
16	DVDD	Digital I/O supply

## 7 SPECIFICATIONS

### 7.1 Absolute Maximum Ratings

Over operating free-air temperature range (unless otherwise noted) <sup>(1)</sup>

		MIN	MAX	UNIT
Voltage	AVDD to GND, DVDD to GND <sup>(2)</sup>	-0.3	6	V
	Digital input voltage to GND	-0.3	DVDD+0.3	
	Digital output pin <sup>(3)</sup>	-0.3	DVDD+0.3	
Current	Signal input pin	-10	10	mA
$\theta_{JA}$	Package thermal impedance <sup>(4)</sup>	QFN3x3-16		°C/W
Temperature	Operating range, $T_A$	-40	125	°C
	Junction, $T_J$ <sup>(5)</sup>	-40	150	
	Storage, $T_{stg}$	-55	150	

(1) Stresses above these ratings may cause permanent damage. Exposure to absolute maximum conditions for extended periods may degrade device reliability. These are stress ratings only, and functional operation of the device at these or any other conditions beyond those specified is not implied.

(2) Input terminals are diode-clamped to the power-supply rails. Input signals that can swing more than 0.3V beyond the supply rails should be current-limited to 10mA or less.

(3) Include  $\overline{CS}$ , SCLK, SDO.

(4) The package thermal impedance is calculated in accordance with JESD-51.

(5) The maximum power dissipation is a function of  $T_{J(MAX)}$ ,  $R_{\theta JA}$ , and  $T_A$ . The maximum allowable power dissipation at any ambient temperature is  $P_D = (T_{J(MAX)} - T_A) / R_{\theta JA}$ . All numbers apply for packages soldered directly onto a PCB.

### 7.2 ESD Ratings

The following ESD information is provided for handling of ESD-sensitive devices in an ESD protected area only.

			VALUE	UNIT
$V_{(ESD)}$	Electrostatic discharge	Human-body model (HBM), per ANSI/ESDA/JEDEC JS-001 <sup>(1)</sup>	±2000	V
		Charged-device model (CDM), per ANSI/ESDA/JEDEC JS-002 <sup>(2)</sup>	±500	
		Machine model (MM)	±200	

(1) JEDEC document JEP155 states that 500 V HBM allows safe manufacturing with a standard ESD control process.

(2) JEDEC document JEP157 states that 250 V CDM allows safe manufacturing with a standard ESD control process.



### ESD SENSITIVITY CAUTION

ESD damage can range from subtle performance degradation to complete device failure. Precision integrated circuits may be more susceptible to damage because very small parametric changes could cause the device not to meet its published specifications.

### 7.3 Recommended Operating Conditions

Over operating free-air temperature range (unless otherwise noted)

		MIN	NOM	MAX	UNIT
Supply voltage	AVDD to GND	2.7	3.3	5.25	V
	DVDD to GND	1.65	3.3	AVDD	
Full scale input	$V_{IN} = AINx - AINxGND$	0		$V_{REF}$	V
Operating ambient temperature		-40		125	°C

## 7.4 ELECTRICAL CHARACTERISTICS

( $T_A = -40^{\circ}\text{C}$  to  $+125^{\circ}\text{C}$ ,  $\text{AVDD} = 2.7\text{V}$  to  $5.25\text{V}$ ,  $\text{DVDD} = 1.65\text{V}$  to  $\text{AVDD}$ , input common mode  $= V_{\text{REF}}/2 \pm 0.2$ ,  $f_{\text{SAMPLE}} = 2\text{MSPS}$ , Typical specifications at  $T_A = +25^{\circ}\text{C}$ ,  $\text{AVDD} = 5\text{V}$ ,  $\text{DVDD} = 1.8\text{V}$ , unless otherwise noted.)

PARAMETER	TEST CONDITIONS	MIN	TYP	MAX	UNITS
<b>ANALOG INPUT</b>					
Full-scale input span <sup>(1)</sup>	$\text{AIN}_x - \text{AIN}_x\text{GND}$	0		$V_{\text{REF}}$	V
Absolute input range	$\text{AIN}_0, \text{AIN}_1$	-0.2		$\text{AVDD} + 0.2$	V
	$\text{AIN}_0\text{GND}, \text{AIN}_1\text{GND}$	-0.2		0.2	V
Input capacitance <sup>(2)</sup>			36		pF
Input leakage current	At $+125^{\circ}\text{C}$		1		$\mu\text{A}$
<b>SYSTEM PERFORMANCE</b>					
Resolution			14		Bits
No missing codes		14			Bits
Integral nonlinearity		-2.5	$\pm 1.2$	2.5	LSB <sup>(3)</sup>
Differential linearity		-1	$\pm 0.5$	2	LSB
Offset error <sup>(4)</sup>		-6	$\pm 2$	6	LSB
Gain error		-4	$\pm 2$	4	LSB
Transition noise			60		$\mu\text{V}_{\text{RMS}}$
Power-supply rejection	With 500 Hz sine wave on AVDD		60		dB
<b>DYNAMIC CHARACTERISTICS <sup>(5)</sup></b>					
Total harmonic distortion <sup>(6)</sup>	20kHz, $V_{\text{REF}} = 4.096\text{V}$		-88		dB
Signal to noise ratio	20kHz, $V_{\text{REF}} = 4.096\text{V}$	79	81		dB
	100k Hz, $V_{\text{REF}} = 4.096\text{V}$		81		dB
Signal to noise and distortion ratio	20kHz, $V_{\text{REF}} = 4.096\text{V}$		80		dB
Spurious-free range	20kHz, $V_{\text{REF}} = 4.096\text{V}$		90		dB
Full power bandwidth <sup>(7)</sup>	At -1dB		20		MHz
<b>SAMPLING DYNAMICS</b>					
Conversion time				16	SCLK
Acquisition time		80			ns
Maximum sample rate (throughput rate)	40 MHz SCLK with a 16-clock frame			2	MSPS
Aperture delay <sup>(8)</sup>			10		ns

NOTE:

- (1) Ideal input span; does not include gain or offset error.
- (2) Refer to Figure 30 for sampling circuit details.
- (3) LSB means least significant bit.
- (4) Measured relative to an ideal full-scale input.
- (5) In the dynamic characteristics test, input signal complies with  $\text{PIN} = -0.5\text{dBFS}$
- (6) Calculated on the first nine harmonics of the input frequency.
- (7) Indicates signal bandwidth for undersampling applications.
- (8) Ensured by simulation.

## ELECTRICAL CHARACTERISTICS

( $T_A = -40^{\circ}\text{C}$  to  $+125^{\circ}\text{C}$ ,  $AVDD = 2.7\text{V}$  to  $5.25\text{V}$ ,  $DVDD = 1.65\text{V}$  to  $AVDD$ , input common mode  $= V_{REF}/2 \pm 0.2$ ,  $f_{SAMPLE} = 2\text{MSPS}$ , Typical specifications at  $T_A = +25^{\circ}\text{C}$ ,  $AVDD = 5\text{V}$ ,  $DVDD = 1.8\text{V}$ , unless otherwise noted.)

PARAMETER		CONDITIONS	RS1473			UNITS
			MIN	TYP	MAX	
<b>DIGITAL INPUT/OUTPUT</b>						
$V_{IH}$	High level input voltage		0.7DVDD		DVDD	V
$V_{IL}$	Low level input voltage		GND		0.3DVDD	V
$V_{OH}$	High level output voltage		0.8DVDD			V
$V_{OL}$	Low level output voltage				0.2DVDD	V
$I_{LEAK}$	Input leakage current			$\pm 1$		$\mu\text{A}$
External reference			2.5		AVDD	V
<b>POWER SUPPLY</b>						
	AVDD		2.7	3.3	5.25	V
	DVDD		1.65	3.3	AVDD	V
$I_{AVDD}$	Analog supply current	AVDD = 3.3V, $f_{SAMPLE} = 2\text{MSPS}$		3.6	4.2	mA
		AVDD = 5V, $f_{SAMPLE} = 2\text{MSPS}$		4.5	5.5	
		AVDD = 3.3V, SCLK off		2.7		
		AVDD = 5V, SCLK off		3	3.5	
$I_{DVDD}$	Digital supply current <sup>(9)</sup>	DVDD = 3.3V, $f_{SAMPLE} = 2\text{MSPS}$ SDO load 20pF		850		$\mu\text{A}$
$I_{PD}$	Power down state AVDD supply current	SCLK = 40 MHz		500		$\mu\text{A}$
		SCLK off			2.5	$\mu\text{A}$
$P_{ST}$	Power up time	From power down state using PDEN pin		0.3 <sup>(4)</sup>	1	$\mu\text{s}$
$T_A$	Specified performance		-40		125	$^{\circ}\text{C}$

NOTE:

(9) DVDD consumes only dynamic current.  $I_{DVDD} = C_{LOAD} \times DVDD \times \text{number of } 0 \rightarrow 1 \text{ transitions in SDO} \times f_{SAMPLE}$ . This is a load-dependent current and there is no DVDD current when the output is not toggling.

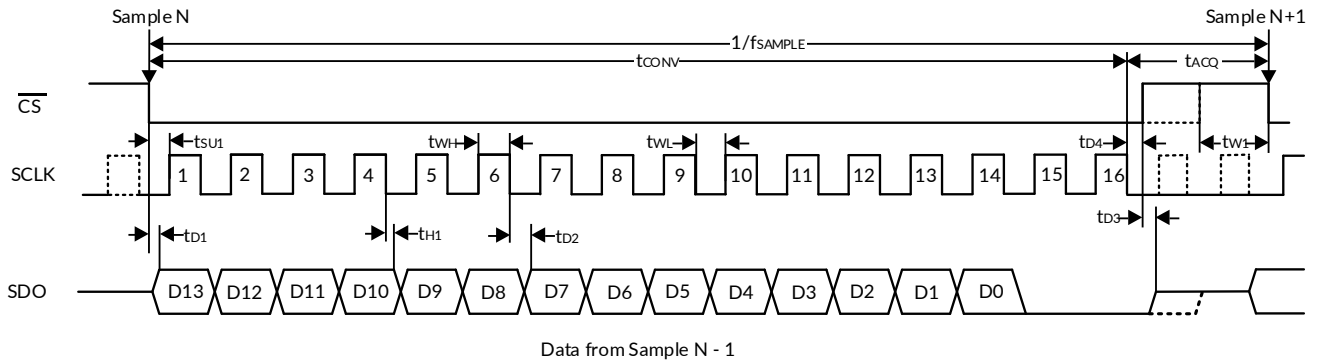

## 7.5 Timing DIAGRAM:RS1473

**Table 2. TIMING REQUIREMENTS: RS1473 (1)**

PARAMETER		TEST CONDITIONS (2)	MIN	TYP	MAX	UNITS
t <sub>CONV</sub>	Conversion time				16	SCLK
t <sub>ACQ</sub>	Acquisition time		80			ns
t <sub>SAMPLE</sub>	Sample rate (throughput rate)	SCLK=40MHz 16-clock frame			2	MSPS
t <sub>w1</sub>	Pulse width $\overline{CS}$ high		25			ns
t <sub>D1</sub>	Delay time, $\overline{CS}$ low to first data (D0~D15) out	DVDD = 1.8V			14.5	ns
		DVDD = 3V			12.5	ns
		DVDD = 5V			8.5	ns
t <sub>SU1</sub>	Setup time, $\overline{CS}$ low to first rising edge of SCLK	DVDD = 1.8V	3.5			ns
		DVDD = 3V	3.5			ns
		DVDD = 5V	3.5			ns
t <sub>D2</sub> (3)	Delay time, SCLK falling to SDO	DVDD = 1.8V			11	
		DVDD = 3V			9	
		DVDD = 5V			7.1	
t <sub>H1</sub>	Hold time, SCLK falling to data valid	DVDD = 1.8V	4			ns
		DVDD = 3V	3			ns
		DVDD = 5V	2			ns
t <sub>D3</sub>	Delay time, $\overline{CS}$ high to SDO 3-state	DVDD = 1.8V			15	ns
		DVDD = 3V			12.5	ns
		DVDD = 5V			8.5	ns
t <sub>D4</sub>	Delay time, $\overline{CS}$ rising edge from conversion end		10			ns
t <sub>wH</sub>	Pulse duration, SCLK high		8			ns
t <sub>wL</sub>	Pulse duration, SCLK low		8			ns
SCLK frequency					40	MHz
t <sub>PDSU</sub>	Setup time, PDEN high to $\overline{CS}$ rising edge		2			ns
t <sub>PDH</sub>	Hold time, $\overline{CS}$ rising edge to PDEN falling edge		20			ns

(1) All specifications are ensured by simulations at T<sub>A</sub> = -40°C to +125°C, and DVDD = 1.65 V to AVDD, unless otherwise noted.

(2) 1.8 V specifications apply from 1.65 V to 2 V; 3 V specifications apply from 2.7 V to 3.6 V; 5 V specifications apply from 4.75V to 5.25V.

(3) With 20 pF load.

## 7.6 TYPICAL CHARACTERISTICS

NOTE: The graphs and tables provided following this note are a statistical summary based on a limited number of samples and are provided for informational purposes only.

At  $T_A = +25^\circ\text{C}$ ,  $AVDD = 5.0\text{ V}$ ,  $DVDD = 1.8\text{ V}$ ,  $VREF = 2.5\text{ V}$ ,  $f_{\text{SAMPLE}} = 2\text{ MSPS}$ ,  $f_{\text{IN}} = 20\text{ kHz}$ ,  $P_{\text{IN}} = -0.5\text{ dBFS}$ ,  $f_{\text{SCLK}} = 40\text{ MHz}$ , and  $PDEN = 0$  (unless otherwise noted).

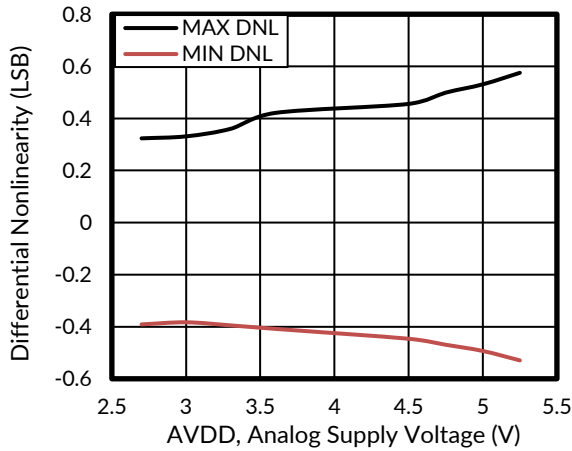

**Figure 3. DNL vs ANALOG SUPPLY VOLTAGE**

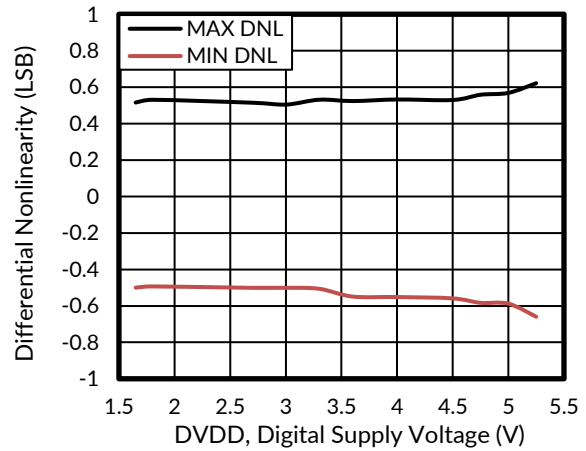

**Figure 4. DNL vs DIGITAL SUPPLY VOLTAGE**

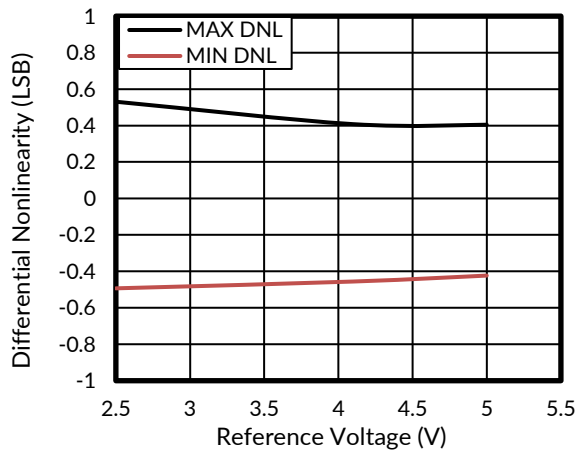

**Figure 5. DNL vs REFERENCE VOLTAGE**

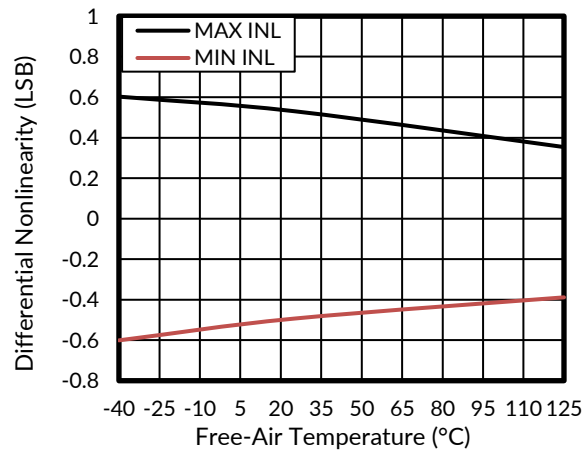

**Figure 6. DNL vs Free-Air Temperature**

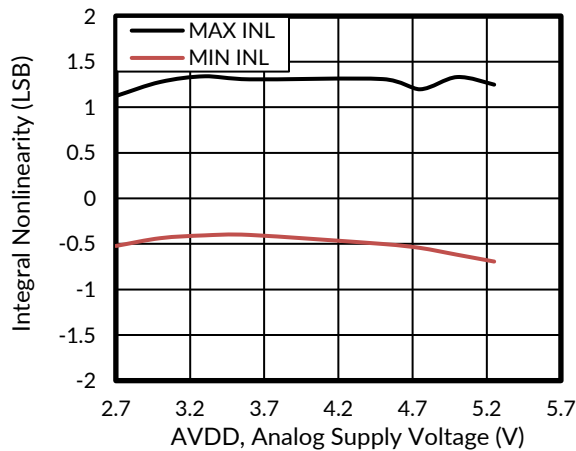

**Figure 7. INL vs ANALOG SUPPLY VOLTAGE**

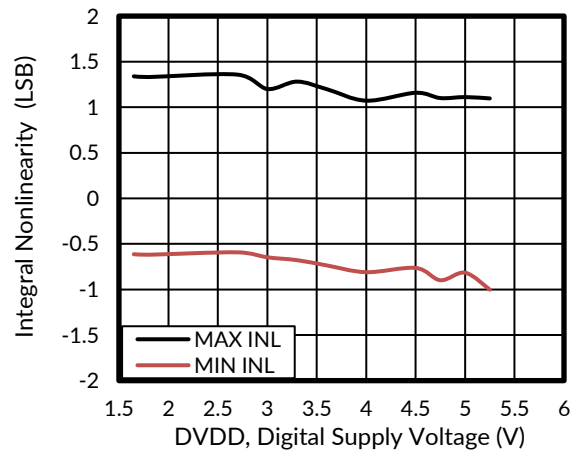
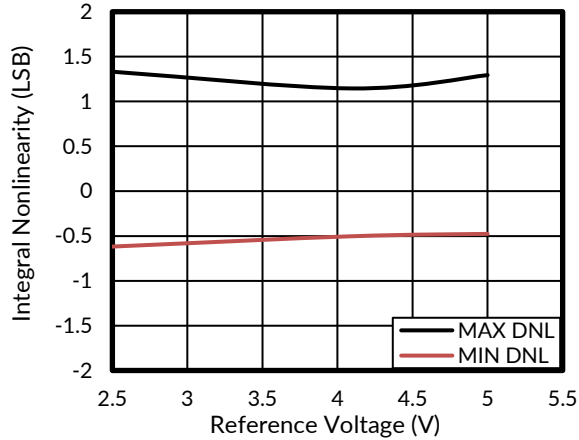

**Figure 8. INL vs DIGITAL SUPPLY VOLTAGE**

## TYPICAL CHARACTERISTICS

NOTE: The graphs and tables provided following this note are a statistical summary based on a limited number of samples and are provided for informational purposes only.

At  $T_A = +25^\circ\text{C}$ ,  $AVDD = 5.0\text{ V}$ ,  $DVDD = 1.8\text{ V}$ ,  $VREF = 2.5\text{ V}$ ,  $f_{\text{SAMPLE}} = 2\text{ MSPS}$ ,  $f_{\text{IN}} = 20\text{ kHz}$ ,  $f_{\text{SCLK}} = 40\text{ MHz}$ , and  $\text{PDEN} = 0$  (unless otherwise noted).



**Figure 9. INL vs REFERENCE VOLTAGE**

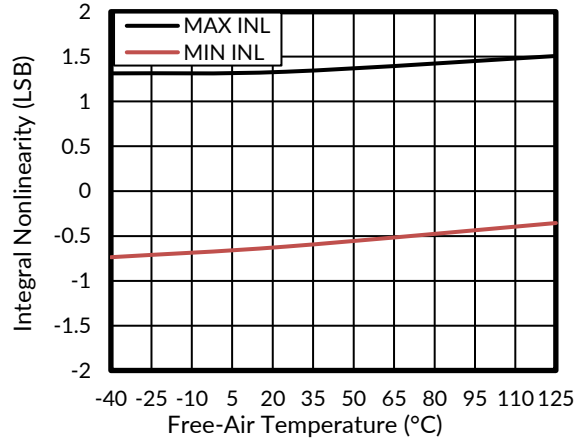

**Figure 10. INL vs Free-Air Temperature**

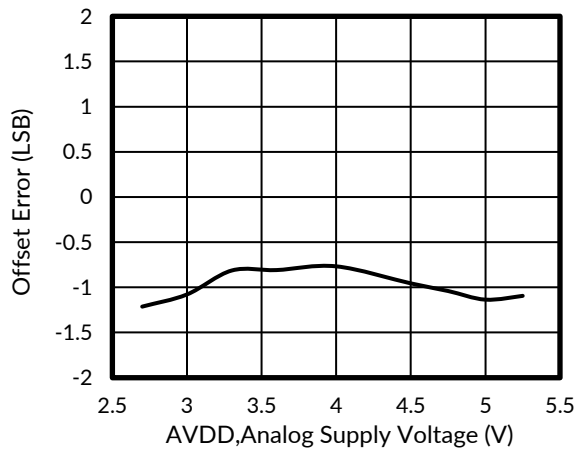

**Figure 11. OFFSET ERROR vs ANALOG SUPPLY VOLTAGE**

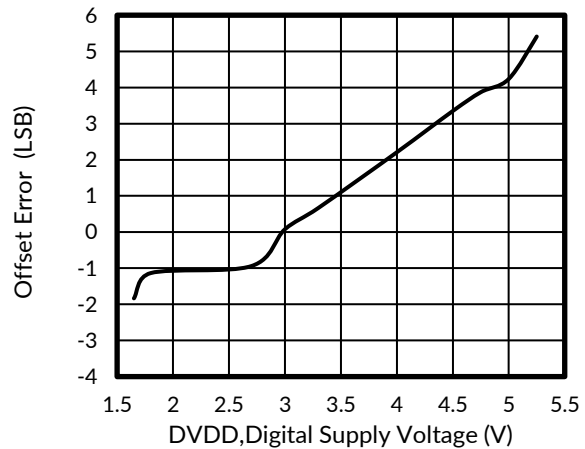

**Figure 12. OFFSET ERROR vs DIGITAL SUPPLY VOLTAGE**

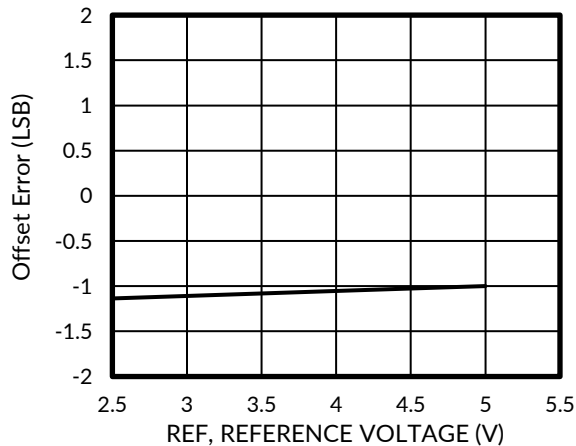

**Figure 13. OFFSET ERROR vs REFERENCE VOLTAGE**

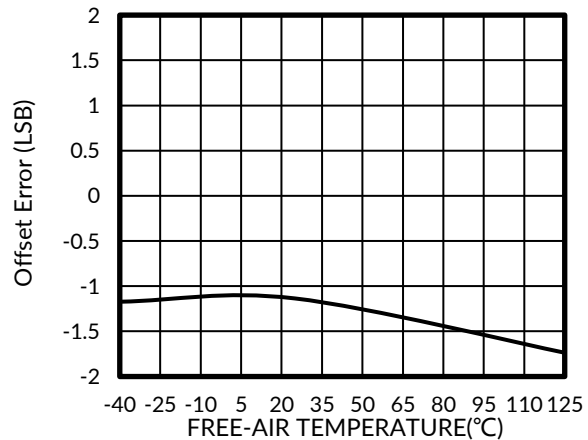
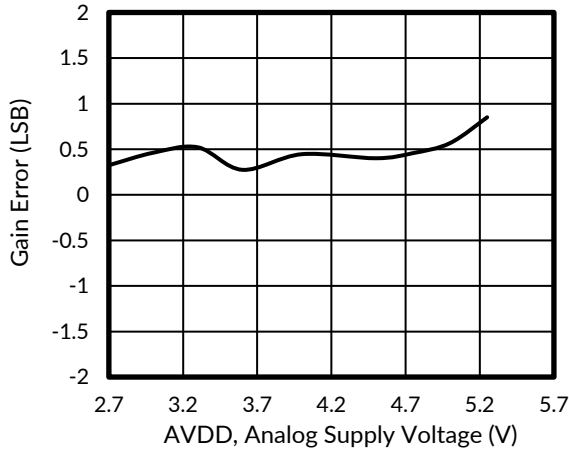

**Figure 14. OFFSET ERROR vs FREE-AIR TEMPERATURE**

## TYPICAL CHARACTERISTICS

NOTE: The graphs and tables provided following this note are a statistical summary based on a limited number of samples and are provided for informational purposes only.

At  $T_A = +25^\circ\text{C}$ ,  $AVDD = 5.0\text{ V}$ ,  $DVDD = 1.8\text{ V}$ ,  $VREF = 2.5\text{ V}$ ,  $f_{\text{SAMPLE}} = 2\text{ MSPS}$ ,  $f_{\text{IN}} = 20\text{ kHz}$ ,  $f_{\text{SCLK}} = 40\text{ MHz}$ , and  $\text{PDEN} = 0$  (unless otherwise noted).



**Figure 15. GAIN ERROR vs ANALOG SUPPLY VOLTAGE**

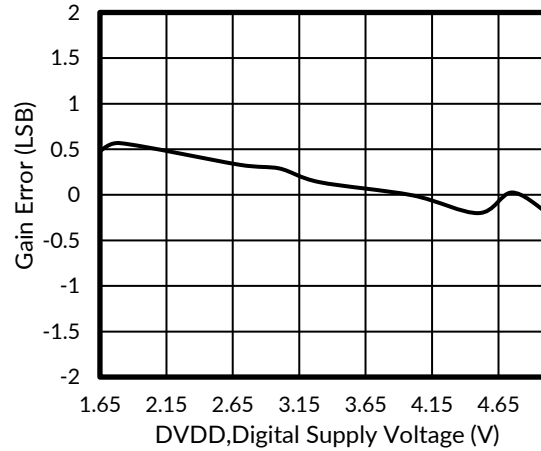

**Figure 16. GAIN ERROR vs DIGITAL SUPPLY VOLTAGE**

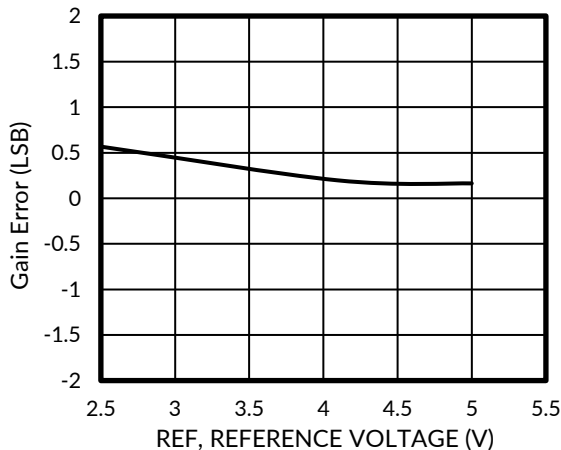

**Figure 17. GAIN ERROR vs REFERENCE VOLTAGE**

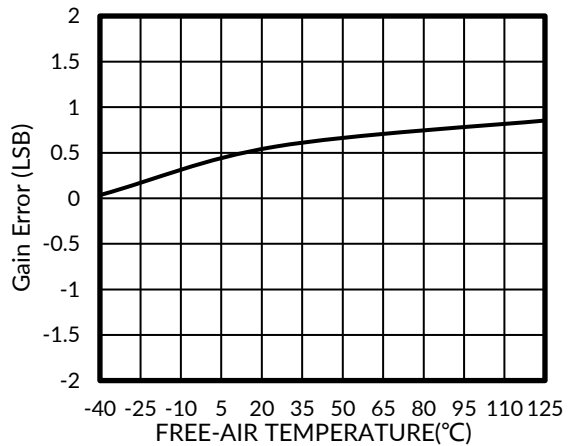

**Figure 18. GAIN ERROR vs FREE-AIR TEMPERATURE**

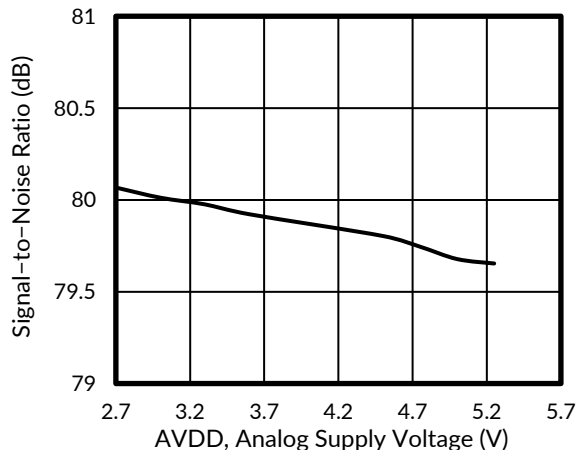

**Figure 19. SNR vs ANALOG SUPPLY VOLTAGE**

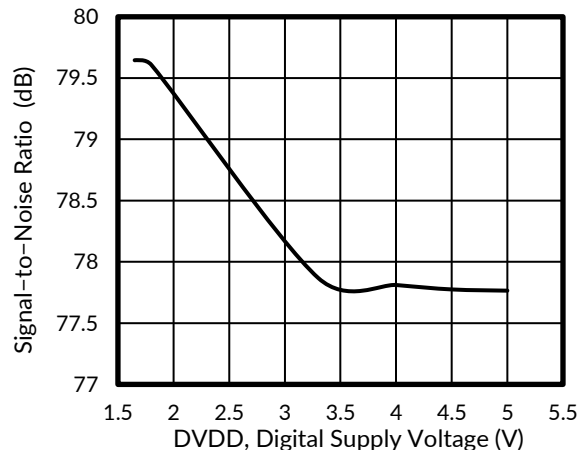
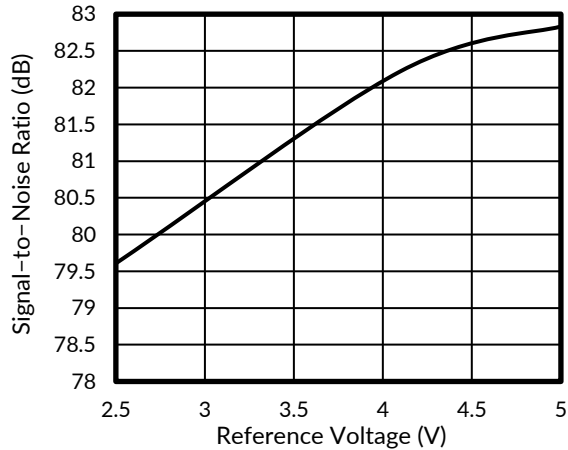

**Figure 20. SNR vs DIGITAL SUPPLY VOLTAGE**

## TYPICAL CHARACTERISTICS

NOTE: The graphs and tables provided following this note are a statistical summary based on a limited number of samples and are provided for informational purposes only.

At  $T_A = +25^\circ\text{C}$ ,  $AVDD = 5.0\text{ V}$ ,  $DVDD = 1.8\text{ V}$ ,  $VREF = 2.5\text{ V}$ ,  $f_{\text{SAMPLE}} = 2\text{ MSPS}$ ,  $f_{\text{IN}} = 20\text{ kHz}$ ,  $f_{\text{SCLK}} = 40\text{ MHz}$ , and  $\text{PDEN} = 0$  (unless otherwise noted).



**Figure 21. SNR vs REFERENCE VOLTAGE**

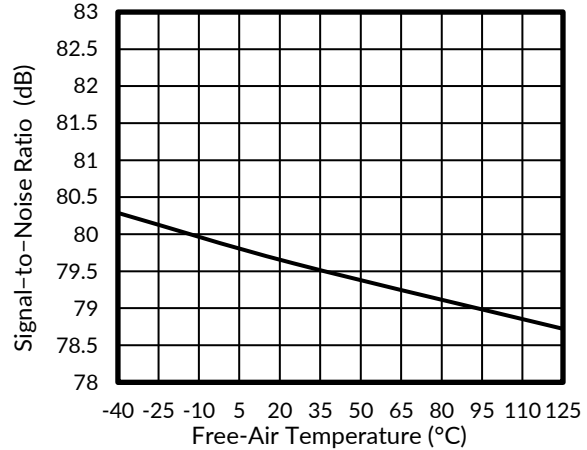

**Figure 22. SNR vs Free-Air Temperature**

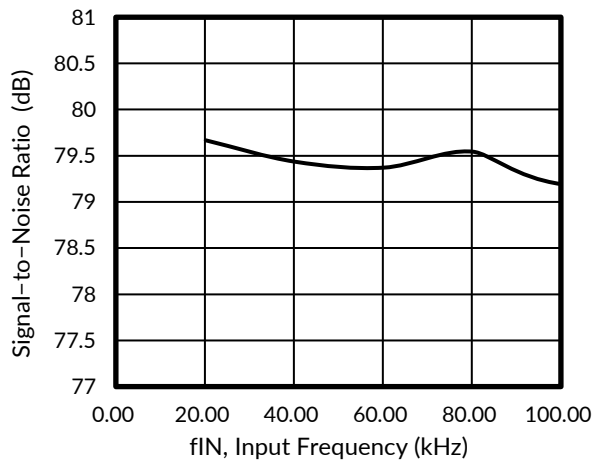

**Figure 23. SNR vs INPUT FREQUENCY**

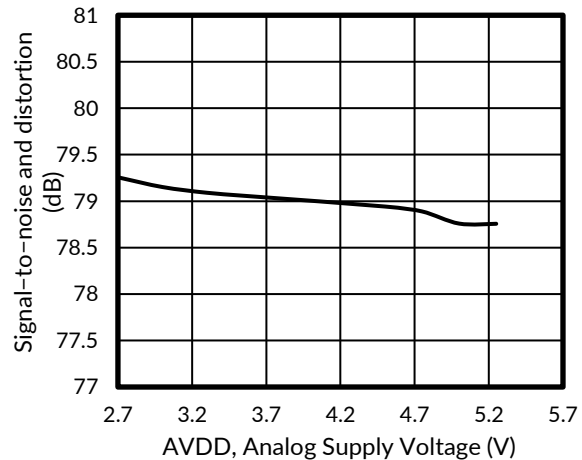

**Figure 24. SINAD vs ANALOG SUPPLY VOLTAGE**

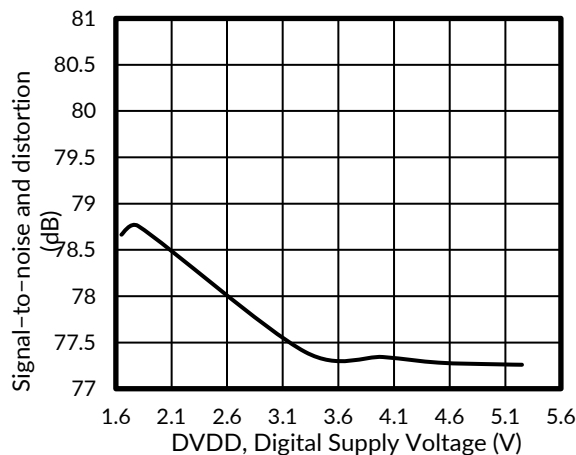

**Figure 25. SINAD vs DIGITAL SUPPLY VOLTAGE**

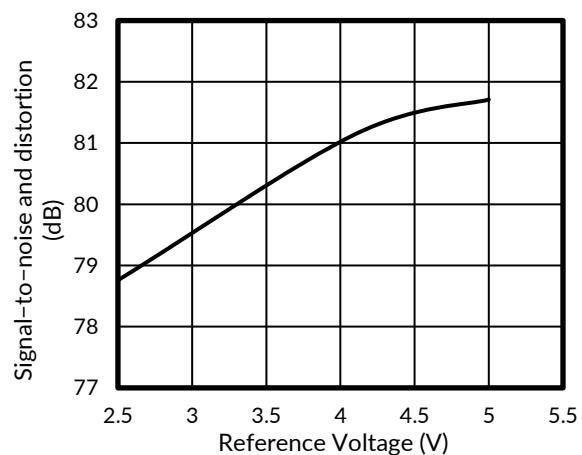
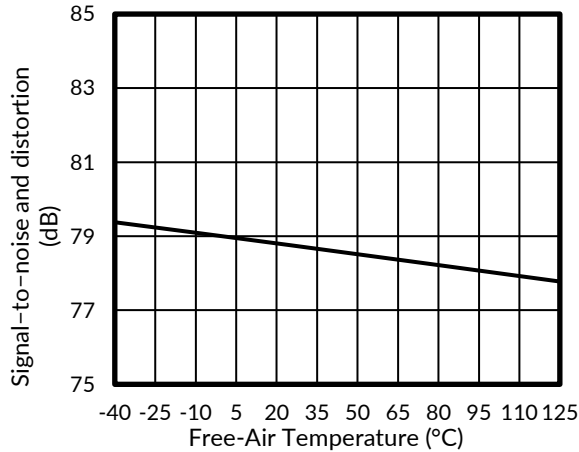

**Figure 26. SINAD vs REFERENCE VOLTAGE**

## TYPICAL CHARACTERISTICS

NOTE: The graphs and tables provided following this note are a statistical summary based on a limited number of samples and are provided for informational purposes only.

At  $T_A = +25^\circ\text{C}$ ,  $AVDD = 5.0\text{ V}$ ,  $DVDD = 1.8\text{ V}$ ,  $VREF = 2.5\text{ V}$ ,  $f_{\text{SAMPLE}} = 2\text{ MSPS}$ ,  $f_{\text{IN}} = 20\text{ kHz}$ ,  $f_{\text{SCLK}} = 40\text{ MHz}$ , and  $\text{PDEN} = 0$  (unless otherwise noted).



**Figure 27. SINAD vs Free-Air Temperature**

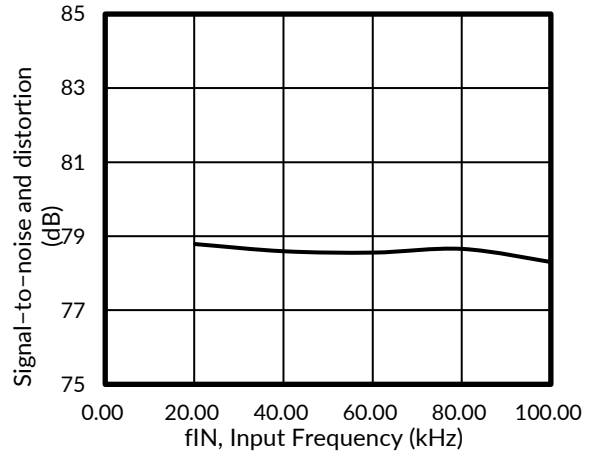

**Figure 28. SINAD vs INPUT FREQUENCY**

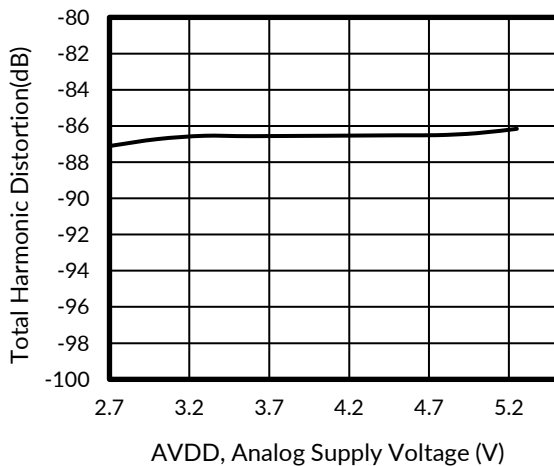

**Figure 29. THD vs ANALOG SUPPLY VOLTAGE**

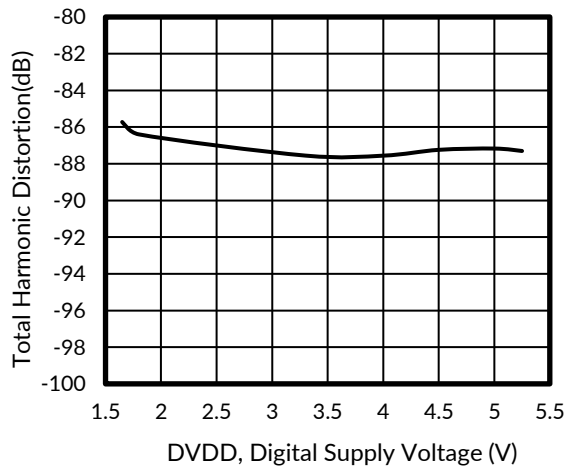

**Figure 30. THD vs DIGITAL SUPPLY VOLTAGE**

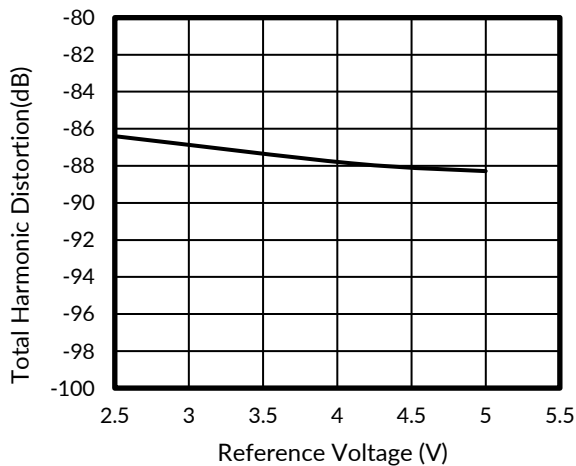

**Figure 31. THD vs REFERENCE VOLTAGE**

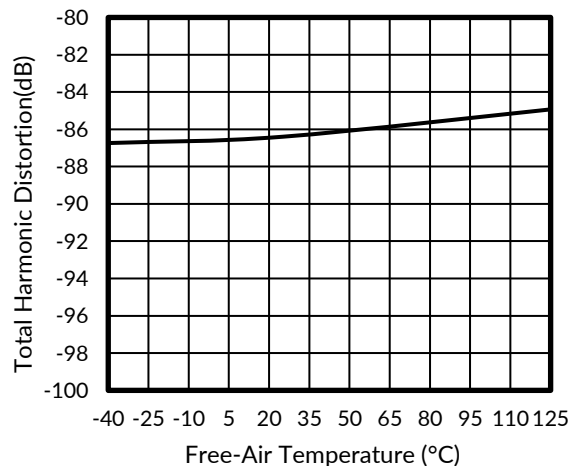
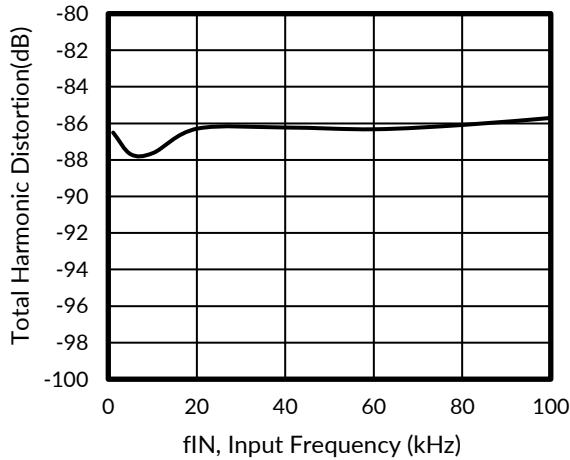

**Figure 32. THD vs Free-Air Temperature**

## TYPICAL CHARACTERISTICS

NOTE: The graphs and tables provided following this note are a statistical summary based on a limited number of samples and are provided for informational purposes only.

At  $T_A = +25^\circ\text{C}$ ,  $AVDD = 5.0\text{ V}$ ,  $DVDD = 1.8\text{ V}$ ,  $VREF = 2.5\text{ V}$ ,  $f_{\text{SAMPLE}} = 2\text{ MSPS}$ ,  $f_{\text{IN}} = 20\text{ kHz}$ ,  $f_{\text{SCLK}} = 40\text{ MHz}$ , and  $\text{PDEN} = 0$  (unless otherwise noted).



**Figure 33. THD vs INPUT FREQUENCY**

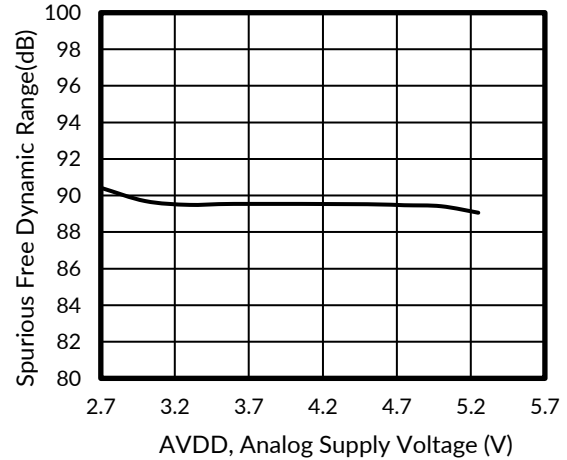

**Figure 34. SFDR vs ANALOG SUPPLY VOLTAGE**

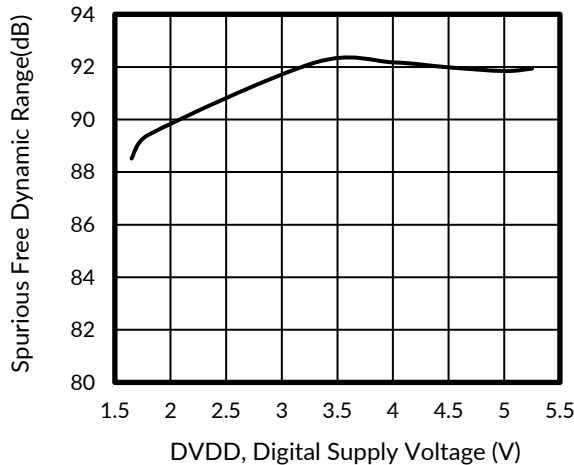

**Figure 35. SFDR vs DIGITAL SUPPLY VOLTAGE**

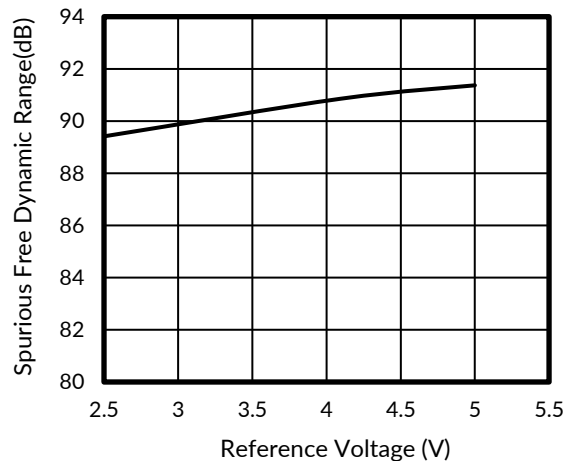

**Figure 36. SFDR vs REFERENCE VOLTAGE**

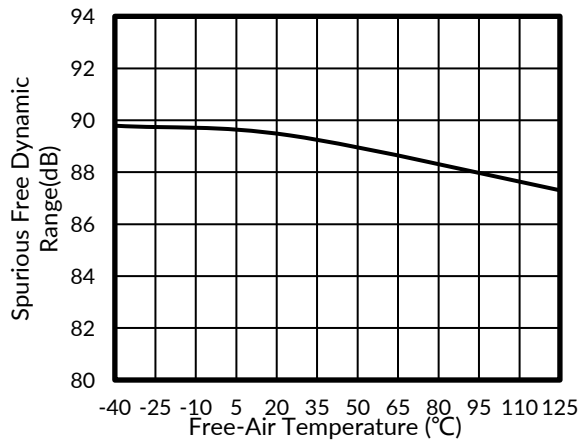

**Figure 37. SFDR vs FREE-AIR TEMPERATURE**

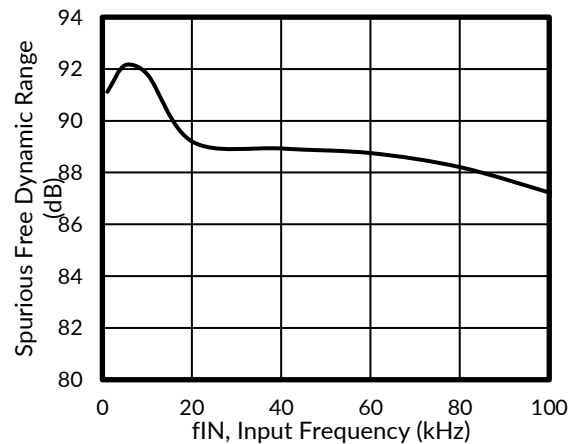
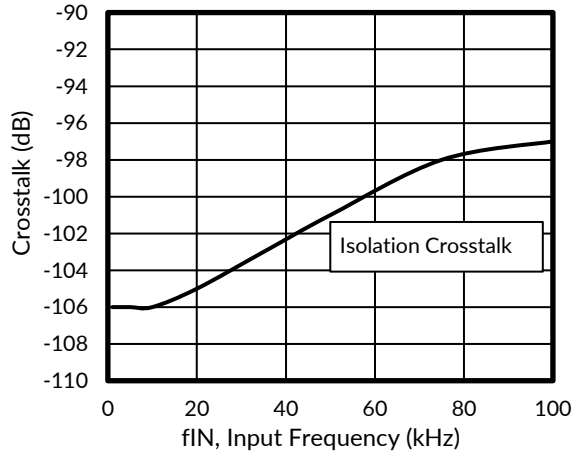

**Figure 38. SFDR vs INPUT FREQUENCY**

## TYPICAL CHARACTERISTICS

NOTE: The graphs and tables provided following this note are a statistical summary based on a limited number of samples and are provided for informational purposes only.

At  $T_A = +25^\circ\text{C}$ ,  $AVDD = 5.0\text{ V}$ ,  $DVDD = 1.8\text{ V}$ ,  $VREF = 2.5\text{ V}$ ,  $f_{\text{SAMPLE}} = 2\text{ MSPS}$ ,  $f_{\text{IN}} = 20\text{ kHz}$ ,  $f_{\text{CLK}} = 40\text{ MHz}$ , and  $PDEN = 0$  (unless otherwise noted).



**Figure 39. CROSSTALK vs INPUT FREQUENCY**

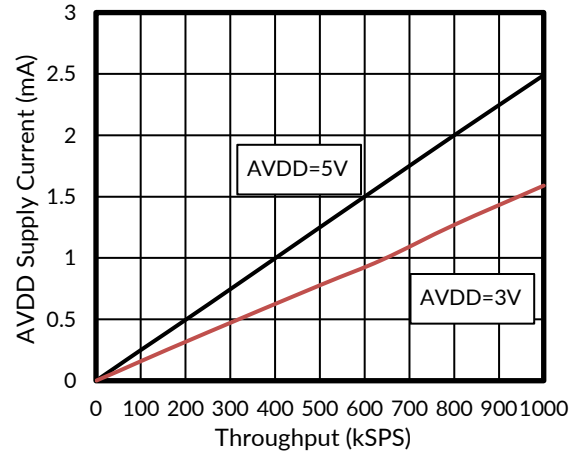

**Figure 40. ANALOG SUPPLY CURRENT (Dynamic) vs SAMPLE RATE**

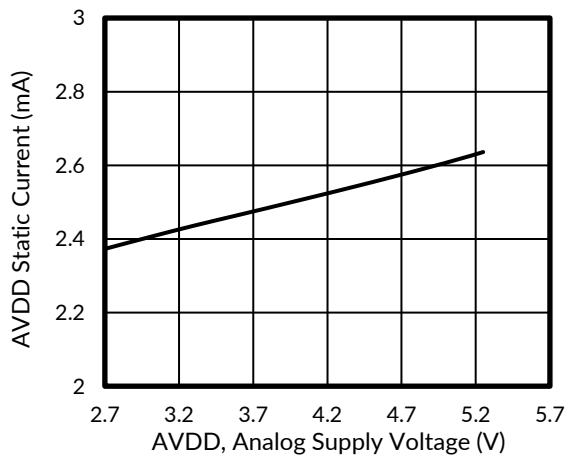

**Figure 41. ANALOG SUPPLY CURRENT (Static) vs ANALOG SUPPLY VOLTAGE**

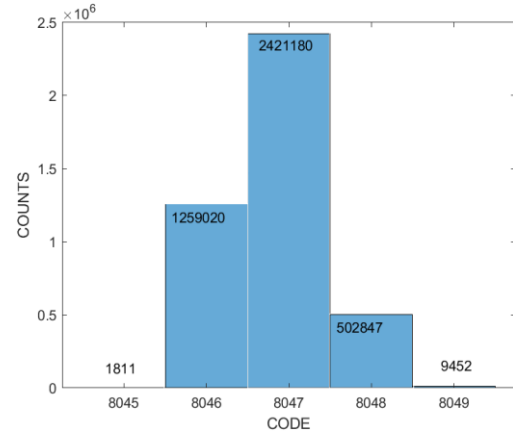

**Figure 42. Histogram of a DC Input near Code Center**

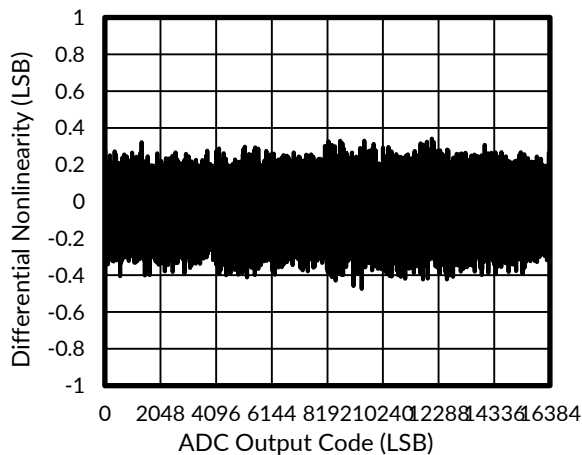

**Figure 43. Differential Nonlinearity vs Code**

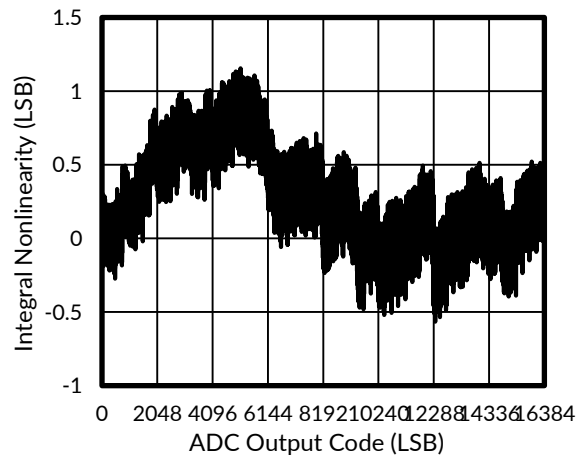

**Figure 44. Integral Nonlinearity vs Code**



## TYPICAL CHARACTERISTICS

NOTE: The graphs and tables provided following this note are a statistical summary based on a limited number of samples and are provided for informational purposes only.

At  $T_A = +25^\circ\text{C}$ ,  $AVDD = 5.0\text{ V}$ ,  $DVDD = 1.8\text{ V}$ ,  $VREF = 2.5\text{ V}$ ,  $f_{\text{SAMPLE}} = 2\text{ MSPS}$ ,  $f_{\text{IN}} = 20\text{ kHz}$ ,  $f_{\text{SCLK}} = 40\text{ MHz}$ , and  $\text{PDEN} = 0$  (unless otherwise noted).

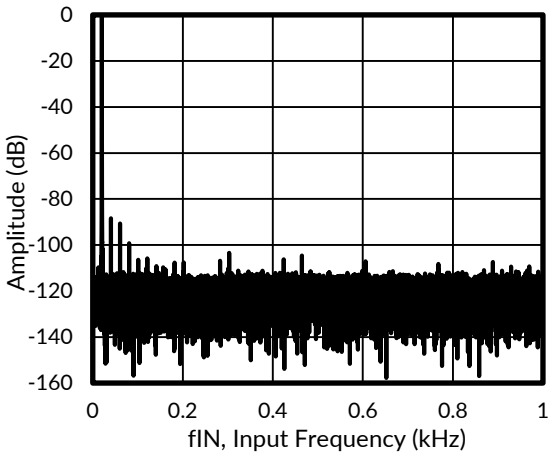

**Figure 45. 20 kHz FFT, VREF = 2.5 V**

## 8 OVERVIEW

The RS1473 is a 14-bit, miniature, dual-channel, low-power, single-ended input SAR ADC. The PDEN pin enables an auto power-down mode that further reduces power consumption at lower speeds.

### 8.1 MULTIPLEXER AND ADC INPUT

The RS1473 features a single-ended input with a double-pole, double-throw multiplexer. The ground sense inputs (AINxGND) can accept swings of  $\pm 0.2$  V whereas the inputs (AINx) allow signals in the range of 0 V to  $V_{REF}$  over the ground sense input. The ADC converts the difference in voltage:  $V_{AINx} - V_{AINxGND}$ . This feature can be used in multiple ways. For example, two signals can be connected from different sensors with unequal ground potentials (within  $\pm 0.2$  V) to a single ADC. The ADC rejects the common-mode offset and noise. This feature also allows the use of a single-supply op amp. The signal and the AINxGND input can be offset by +0.2 V, which provides the ground clearance required for a single-supply op amp.

Figure 46 shows the electrostatic discharge (ESD) diodes to supply and ground at every analog input. Make sure that these diodes do not turn on by keeping the supply voltage within the specified input range.

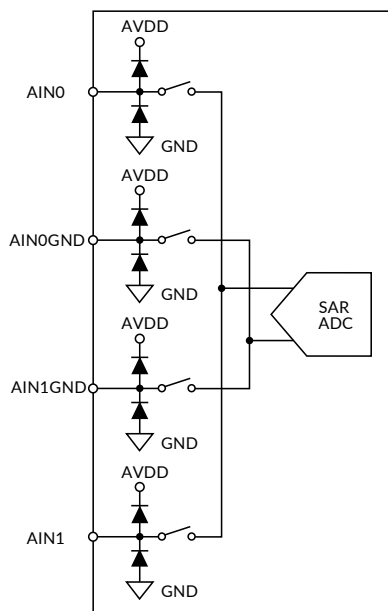

**Figure 46. Analog Inputs**

Figure 47 shows an equivalent circuit of the multiplexer and ADC sampling stage. See the Application Information section for details on the driving circuit. The positive and negative sense inputs are separately sampled on 36 pF sampling capacitors. The multiplexer and sampling switches are represented by an ideal switch in series with an about 50  $\Omega$  resistance. Note that this is dc resistance and can be used for step-settling calculations (do not use the RC values shown in Figure 47 for 3 dB bandwidth calculations for undersampling applications). During sampling, the devices connect the 36pF sampling capacitor to the ADC driver. This connection creates a glitch at the device input. It is recommended to connect a capacitor across the AINx and AINxGND terminals to reduce this glitch. A driving circuit must have sufficient bandwidth to settle this glitch within the acquisition time.

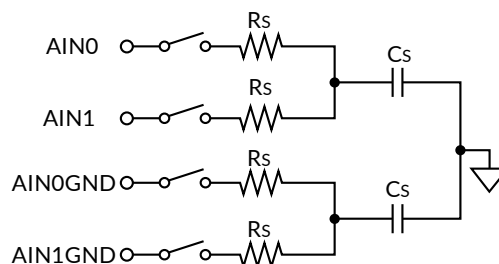

**Figure 47. Input Sampling Stage Equivalent Circuit**

Figure 48 shows a timing diagram for the ADC analog input channel selection. As shown in Figure 48, the CH\_SEL signal selects the analog input channel to the ADC. CH\_SEL = 0 selects channel 0 and CH\_SEL = 1 selects channel 1. It is recommended not to toggle the CH\_SEL signal during an ADC acquisition phase until the device sees the first valid SCLK rising edge after the device samples the analog input. If CH\_SEL is toggled during this period, it can cause erroneous output code because the device might see unsettled analog input. CH\_SEL can be toggled at any time during the window specified in Figure 48; however, it is recommended to select the desired channel after the first SCLK rising edge and before the second SCLK rising edge. This timing ensures that the multiplexer output is settled before the ADC starts acquisition of the analog input.

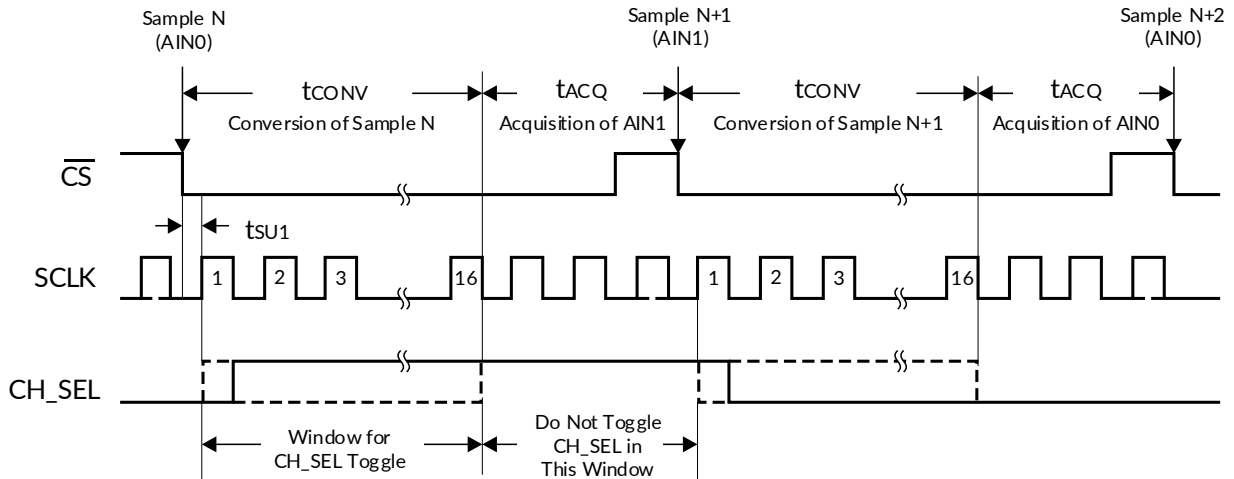
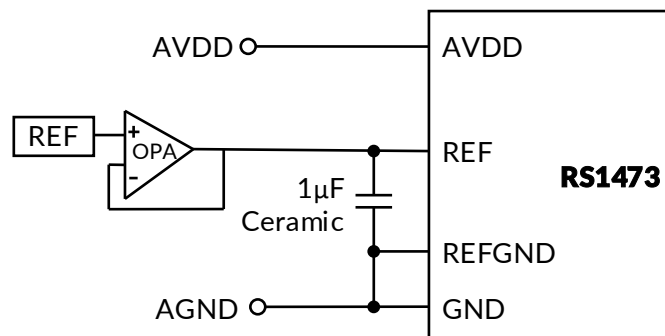

**Figure 48. ADC Analog Input Channel Selection**

## 8.2 REFERENCE

The RS1473 uses an external reference voltage during the conversion of a sampled signal. The device switches the capacitors used in the conversion process to the reference terminal during conversion. The switching frequency is the same as the SCLK frequency. It is necessary to decouple the REF terminal to REFGND with a 1 $\mu$ F ceramic capacitor in order to get the best noise performance from the device. The capacitor must be placed closest to these pins. Figure 49 shows a typical reference driving circuit.

Sometimes it is convenient to use AVDD as a reference. The RS1473 allow reference ranges up to AVDD. However, make sure that AVDD is well-bypassed and that there is a separate bypass capacitor between REF and REFGND.



**Figure 49. Typical Reference Driving Circuit**

### 8.3 ADC TRANSFER FUNCTION

The RS1473 output is in straight binary format. Figure 50 shows the ideal transfer characteristics for this device. Here, full-scale range (FSR) for the ADC input ( $A_{INx} - A_{INxGND}$ ) is equal to the reference input voltage to the ADC ( $V_{REF}$ ). 1 LSB is equal to  $(V_{REF}/2^N)$ , where N is the resolution of the ADC ( $N = 14$  for the RS1473).

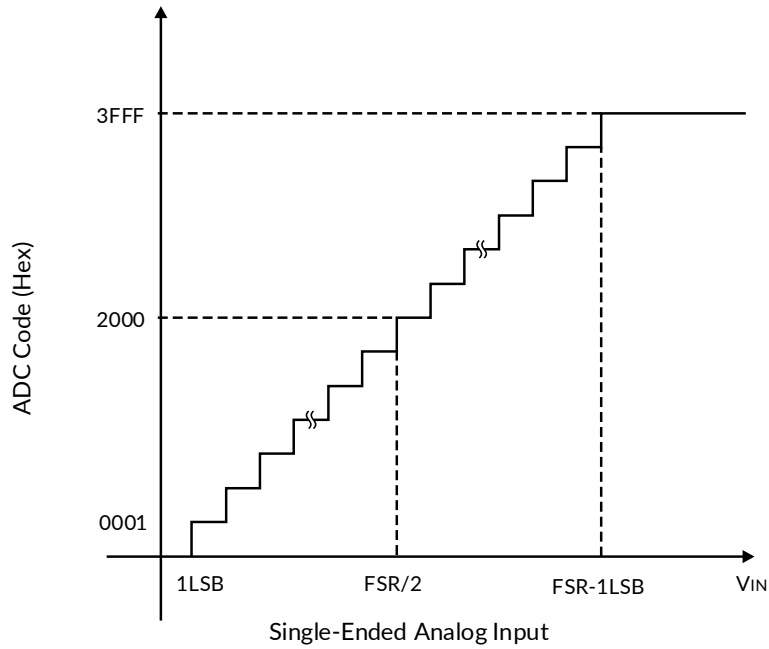

**Figure 50. RS1473 Transfer Characteristics**

## 9 DEVICE OPERATION

The RS1473 operate with either a 16-clock frame or 32-clock frame for ease of interfacing with the host processor.

### 9.1 16-CLOCK FRAME

Figure 51 shows the devices operating in 16-clock mode. This mode is the fastest mode for device operation. In this mode, the devices output data from previous conversions while converting the recently sampled signal.

As shown in Figure 51, the RS1473 start acquisition of the analog input from the 16th falling edge of SCLK. The device samples the input signal on the  $\overline{CS}$  falling edge. SDO comes out of 3-state and the device outputs the MSB on the  $\overline{CS}$  falling edge. The device outputs the next lower SDO bits on every SCLK falling edge after it has first seen the SCLK rising edge. The data correspond to the sample and conversion completed in the previous frame. During a  $\overline{CS}$  low period, the device converts the recently sampled signal. It uses SCLK for conversions. Conversion is complete on the 16th SCLK falling edge.  $\overline{CS}$  can be high at any time after the 16th SCLK falling edge (see the Parameter Measurement Information for more details). The  $\overline{CS}$  rising edge after the 16th SCLK falling edge and before the 29th SCLK falling edge keeps the device in the 16-clock data frame. The device output goes to 3-state when  $\overline{CS}$  is high. It is also permissible to stop SCLK after the device has seen the 16th SCLK falling edge.

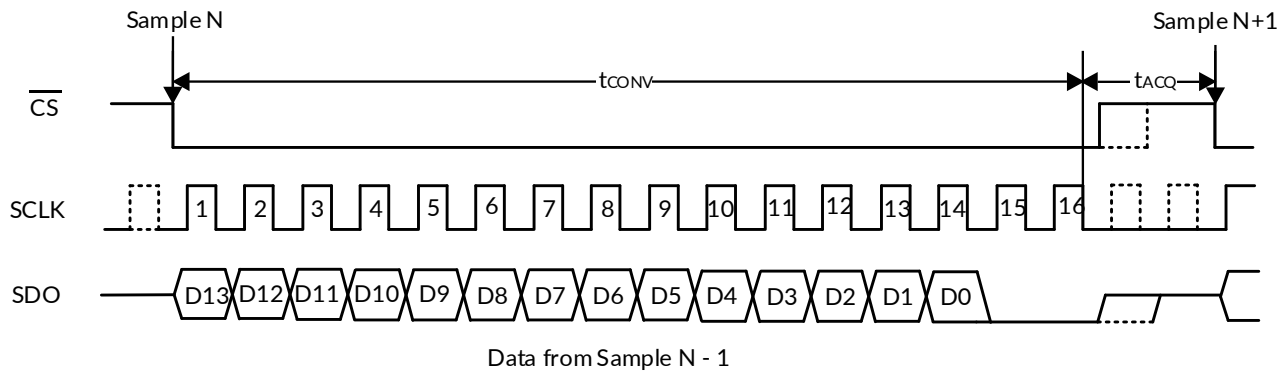

**Figure 51. RS1473 Operating in 16-Clock Mode without Power-Down (PDEN = 0)**

### 9.2 32-CLOCK FRAME

Figure 52 shows the devices operating in 32-clock mode. In this mode, the devices convert and output the data from the most recent sample before taking the next sample.

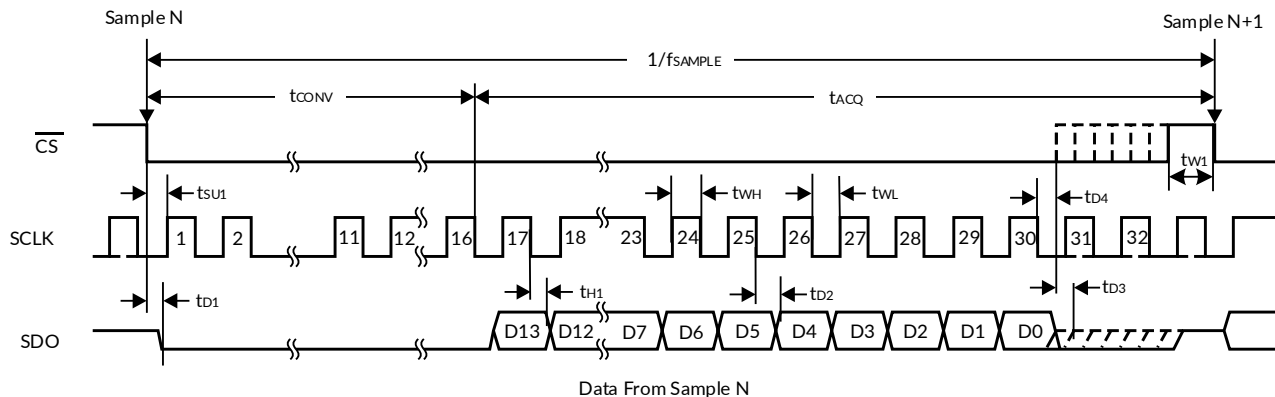

**Figure 52. RS1473 Operation in 32-Clock Frame without Power-Down (PDEN = 0)**

$\overline{CS}$  can be held low past the 16th falling edge of SCLK. The devices continue to output recently converted data starting with the 16th SCLK falling edge. If  $\overline{CS}$  is held low until the 30th SCLK falling edge, then the devices detect 32-clock mode. Note that the device data from recent conversions are already output with no latency before the 30th SCLK falling edge. Once 32-clock mode is detected, the device outputs 16 zeros during the next

conversion (in fact, for the first 16 clocks), unlike 16-clock mode where the devices output the previous conversion result. SCLK can be stopped after the devices have seen the 30th falling edge with  $\overline{CS}$  low.

### 9.3 CONVERSION ABORT

For some event triggered applications such as latching position of absolute position sensor on marker or homing pulse, it is essential to abort ongoing conversion on event and quickly start fresh acquisition. RS1473 features conversion abort function.  $\overline{CS}$  high during conversion (during first 16 clocks) will abort ongoing conversion and start fresh acquisition. Device will sample acquired signal during  $\overline{CS}$  high period on falling edge of  $\overline{CS}$  and will start conversion normally, however data on SDO (conversion results from aborted frame) will not be valid.

For example, if conversion is aborted during 'n<sup>th</sup>' frame and (n+1) is first valid frame after n<sup>th</sup> conversion abort. SDO data during frame number (n+1) (corresponding to n<sup>th</sup> conversion) will not be valid. Conversion results for sample and conversion during frame number (n+1) will be available in frame number (n+2).

### 9.4 POWER-DOWN

The RS1473 offers an easy-to-use power-down feature available through a dedicated PDEN pin (pin 12). A high level on PDEN at the  $\overline{CS}$  rising edge enables the power-down mode for that particular cycle. For speeds below approximately 750 kSPS, it is convenient to use 32-clock mode with power-down. This configuration results in considerable power savings.

As shown in Figure 53, PDEN is held at a logic '1' level. Note that the device looks at the PDEN status only at the  $\overline{CS}$  rising edge; however, for continuous low-speed operation, it is convenient to continuously hold PDEN = 1. The RS1473 detects power-down mode on the  $\overline{CS}$  rising edge with PDEN = 1.

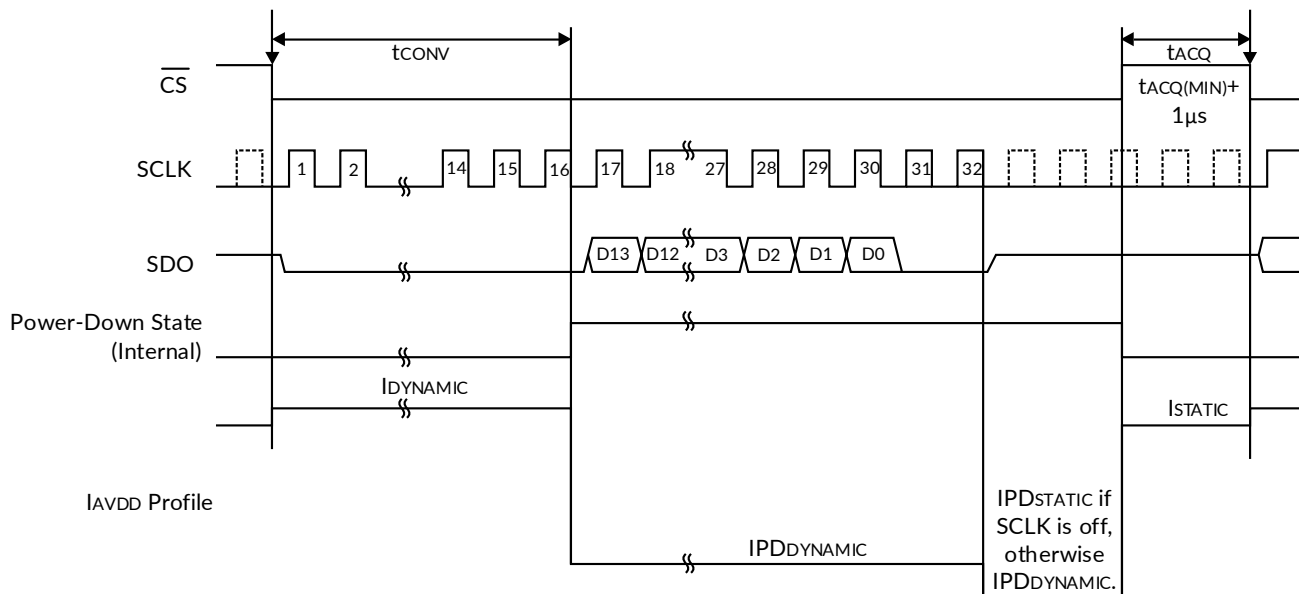

**Figure 53. Power-Down Mode (PDEN = 1)**

On the  $\overline{CS}$  falling edge, the devices start normal operation as previously described. The devices complete conversions on the 16th SCLK falling edge. The devices enter the power-down state immediately after conversions complete. However, the devices can still output data as per the timings described previously. The devices consume dynamic power-down current (IPD-DYNAMIC) during data out operations. It is recommended to stop the clock after the 32nd SCLK falling edge to further save power down to the static power-down current level (IPD-STATIC). The devices power up again on the SCLK rising edge. However, they require an extra 0.5  $\mu$ s to power up completely.  $\overline{CS}$  must be high for the 0.5  $\mu$ s period.

In some applications, data collection is accomplished in burst mode. The system powers down after data collection. 16-clock mode is convenient for these applications. Figure 54 and Figure 55 detail power saving in 16-clock burst mode.

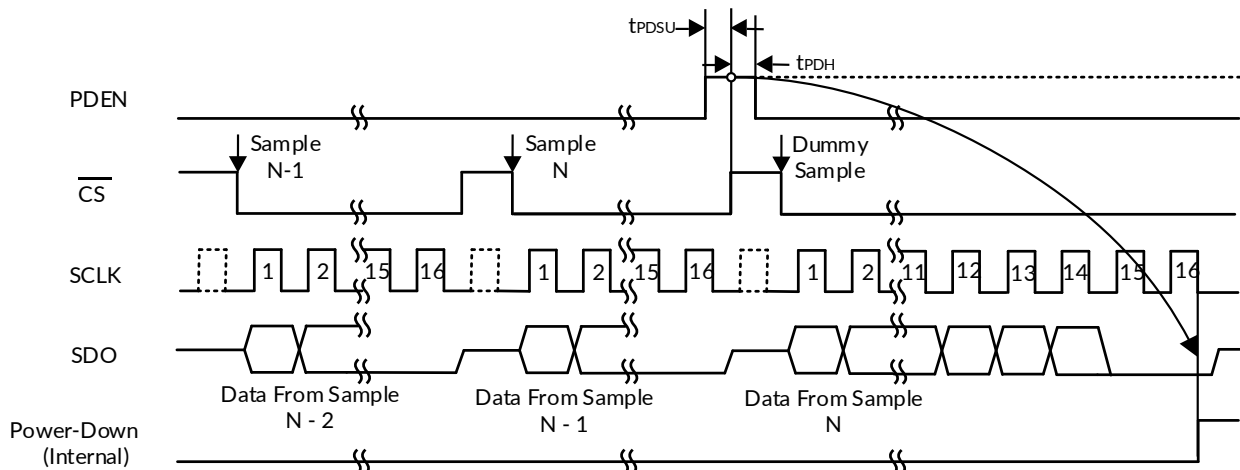

**Figure 54. Entry Into Power-Down with 16-Clock Burst Mode**

As shown in Figure 54, the two frames capturing the N-1 and Nth samples are normal 16-clock frames. Keeping PDEN = 1 before the  $\overline{CS}$  rising edge in the next frame ensures that the devices detect the power-down mode. Data from the Nth sample are read during this frame. It is expected that the Nth sample represents the last data of interest in the burst of conversions. The devices enter the power-down state after the end of conversions. This is the 16th SCLK falling edge. It is recommended to stop the clock after the 16th SCLK falling edge. Note that it is mandatory not to have more than 29 SCLK falling edges during the CS low period. This limitation ensures that the devices remain in 16-clock mode.

The devices remain in a power-down state as long as  $\overline{CS}$  is low. A  $\overline{CS}$  rising edge with PDEN = 0 brings the devices out of the power-down state. It is necessary to ensure that the CS high time for the first sample after power up is more than  $1\ \mu\text{s} + t_{ACQ}(\text{min})$ .

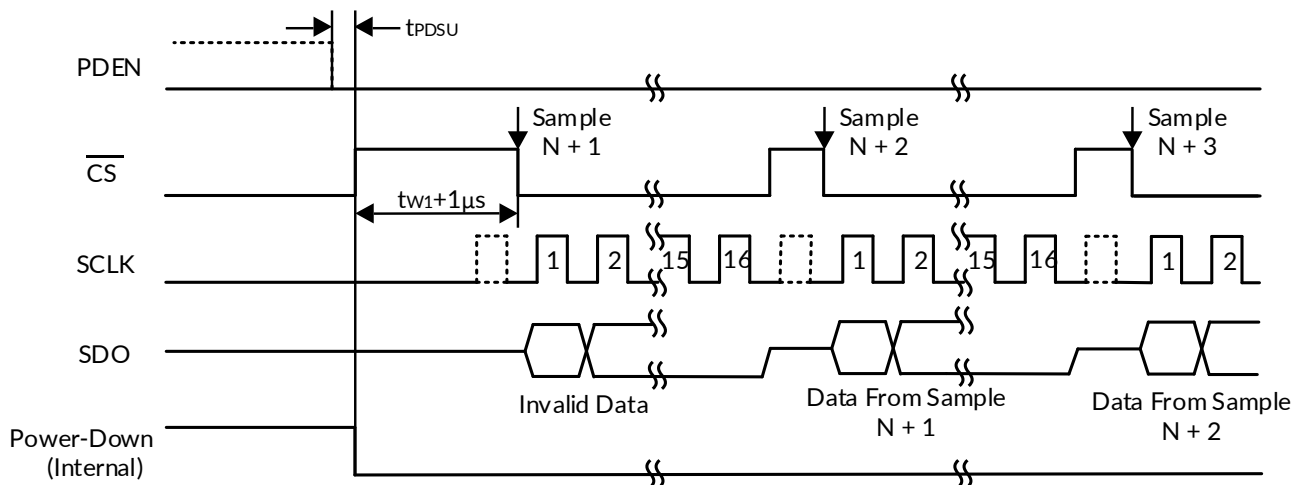

**Figure 55. Exit From Power-Down with 16-Clock Burst Mode**

### 9.5 APPLICATION INFORMATION

The RS1473 employs a sample-and-hold stage at the input. The device connects a 32pF sampling capacitor during sampling. This configuration results in a glitch at the input terminals of the device at the start of the sample. The external circuit must be designed in such a way that the input can settle to the required accuracy during the sampling time chosen. Figure 56 shows a typical driving circuit for the analog inputs.

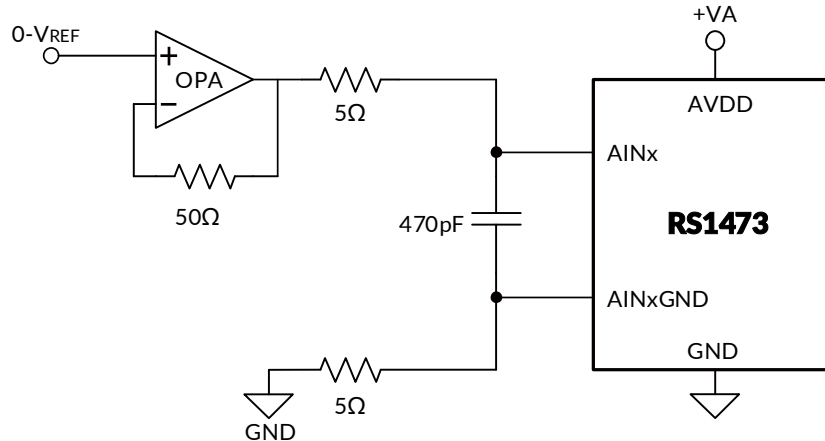

**Figure 56. Typical Input Driving Circuit**

The 470pF capacitor across the AINx and AINxGND terminals decouples the driving op amp from the sampling glitch. It is recommended to split the series resistance of the input filter in two equal values as shown in Figure 56. It is recommended that both input terminals see the same impedance from the external circuit. The low-pass filter at the input limits noise bandwidth of the driving op amps. Select the filter bandwidth so that the full-scale step at the input can settle to the required accuracy during the sampling time. Equation 1, Equation 2, and Equation 3 are useful for filter component selection.

$$\text{Filter Time Constant } (t_{AU}) = \frac{\text{Sampling Time}}{\text{Settling Resolution} \times \ln(2)}$$

Where:

Settling resolution is the accuracy in LSB to which the input needs to settle. A typical settling resolution for the 14-bit device is 15 or 16. (1)

$$\text{Filter Time Constant } (t_{AU}) = R \times C \quad (2)$$

$$\text{Filter Bandwidth} = \frac{1}{2 \times \pi \times t_{AU}} \quad (3)$$

Also, make sure the driving op amp bandwidth does not limit the signal bandwidth below filter bandwidth. In many applications, signal bandwidth may be much lower than filter bandwidth. In this case, an additional low-pass filter may be used at the input of the driving op amp. This signal filter bandwidth can be selected in accordance with the input signal bandwidth.

## 9.6 DRIVING AN ADC WITHOUT A DRIVING OP AMP

For some low input signal bandwidth applications, such as battery power monitoring or mains monitoring, it is not required to operate an ADC at high sampling rates. In fact, it is desirable to avoid using a driving op amp from a cost perspective. In these cases, the ADC input sees the impedance of the signal source (such as a battery or mains transformer). This section elaborates the effects of source impedance on sampling frequency.

Equation 1 can be rewritten as Equation 4:

$$\text{Sampling Time} = \text{Filter Time Constant} \times \text{Settling Resolution} \times \ln(2) \quad (4)$$

As shown in Figure 57, it is recommended to use a bypass capacitor across the positive and negative ADC input terminals.



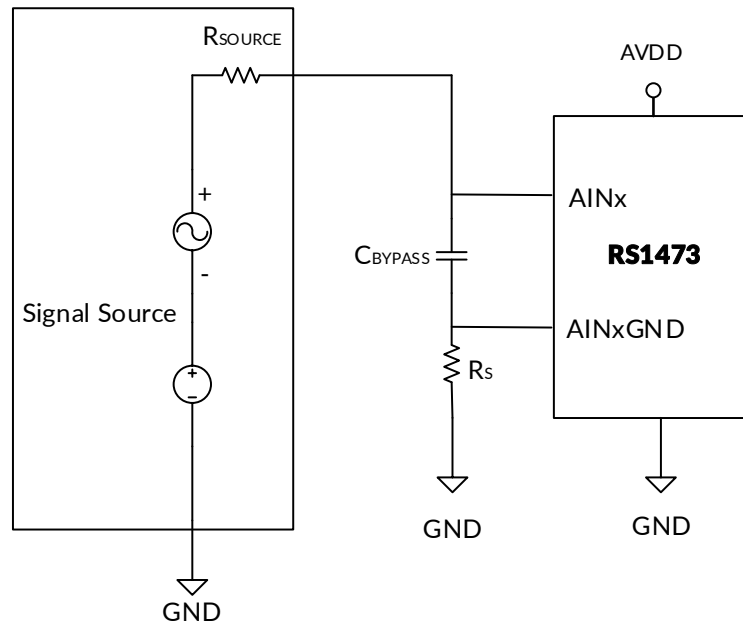

**Figure 57. Driving an RS1473 ADC Without a Driving Op Amp**

Source impedance ( $2 \times R_{SOURCE} + 2 \times R_s$ ) with ( $C_{BYPASS} + C_{SAMPLE}$ ) acts as a low-pass filter with Equation 5:

$$\text{Filter Time Constant} = 2 \times (R_{SOURCE} + R_s) \times (C_{BYPASS} + C_{SAMPLE}) \quad (5)$$

where:

$C_{SAMPLE}$  is the internal sampling capacitance of the ADC (equal to 36 pF).

# 10 PACKAGE OUTLINE DIMENSIONS

## QFN3x3-16<sup>(2)</sup>

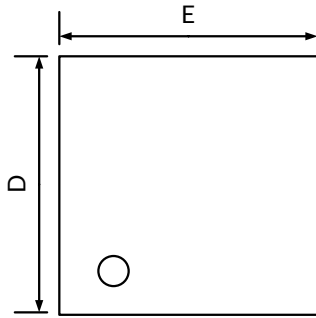

TOP VIEW

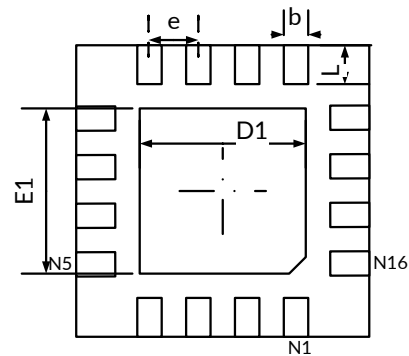

BOTTOM VIEW

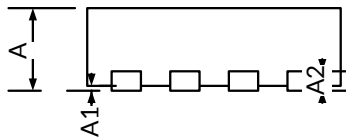

SIDE VIEW

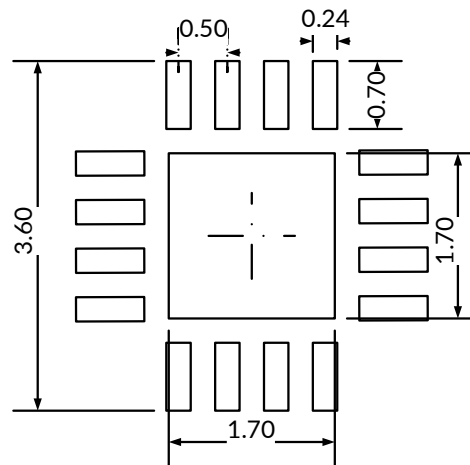

RECOMMENDED LAND PATTERN (Unit: mm)

Symbol	Dimensions In Millimeters		Dimensions In Inches	
	Min	Max	Min	Max
A <sup>(1)</sup>	0.700	0.800	0.028	0.031
A1	0.000	0.050	0.000	0.002
A2	0.203		0.008	
b	0.180	0.300	0.007	0.012
D <sup>(1)</sup>	2.900	3.100	0.114	0.122
D1	1.600	1.800	0.063	0.071
E <sup>(1)</sup>	2.900	3.100	0.114	0.122
E1	1.600	1.800	0.063	0.071
e	0.500 TYP		0.020 TYP	
L	0.300	0.500	0.012	0.020

**NOTE:**

1. Plastic or metal protrusions of 0.075mm maximum per side are not included.
2. This drawing is subject to change without notice.

# 11 TAPE AND REEL INFORMATION

## REEL DIMENSIONS

## TAPE DIMENSION

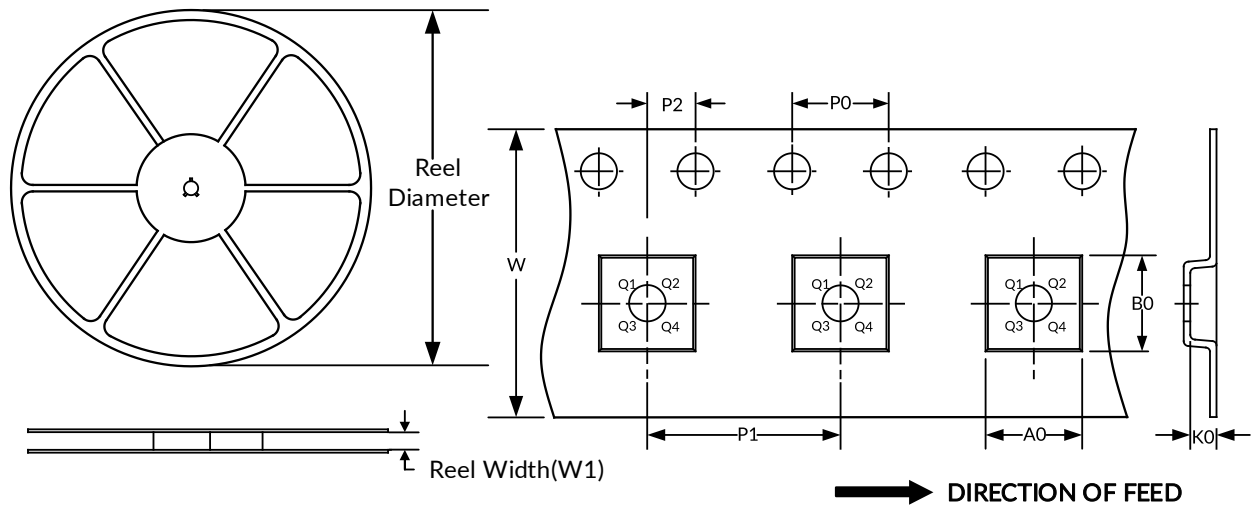

NOTE: The picture is only for reference. Please make the object as the standard.

### KEY PARAMETER LIST OF TAPE AND REEL

Package Type	Reel Diameter	Reel Width(mm)	A0 (mm)	B0 (mm)	K0 (mm)	P0 (mm)	P1 (mm)	P2 (mm)	W (mm)	Pin1 Quadrant
QFN3x3-16	13"	12.4	3.35	3.35	1.13	4.0	8.0	2.0	12.0	Q1

NOTE:

1. All dimensions are nominal.
2. Plastic or metal protrusions of 0.15mm maximum per side are not included.

## **IMPORTANT NOTICE AND DISCLAIMER**

Jiangsu Runic Technology Co., Ltd. will accurately and reliably provide technical and reliability data (including data sheets), design resources (including reference designs), application or other design advice, WEB tools, safety information and other resources, without warranty of any defect, and will not make any express or implied warranty, including but not limited to the warranty of merchantability Implied warranty that it is suitable for a specific purpose or does not infringe the intellectual property rights of any third party.

These resources are intended for skilled developers designing with Runic products You will be solely responsible for: (1) Selecting the appropriate products for your application; (2) Designing, validating and testing your application; (3) Ensuring your application meets applicable standards and any other safety, security or other requirements; (4) Runic and the Runic logo are registered trademarks of Runic Incorporated. All trademarks are the property of their respective owners; (5) For change details, review the revision history included in any revised document. The resources are subject to change without notice. Our company will not be liable for the use of this product and the infringement of patents or third-party intellectual property rights due to its use.

## X-ON Electronics

Largest Supplier of Electrical and Electronic Components

*Click to view similar products for [Analog to Digital Converters - ADC category](#):*

*Click to view products by [RUNIC manufacturer](#):*

Other Similar products are found below :

[MCP37211-200I/TE](#) [AD9235BCPZRL7-40](#) [HT7316ARQZ](#) [ADS1100A3IDBVR](#) [HI1175JCB](#) [HI3-574AJN-5](#) [HI5714/4CB](#) [HI5746KCA](#)  
[HI5766KCAZ](#) [HI5766KCBZ](#) [ISOSD61TR](#) [ES7201](#) [AD7266BSUZ-REEL](#) [AD7708BRZ-REEL7](#) [CLM2543IDW](#) [CLM2543CDW](#)  
[MCP3004T-I/SL](#) [ADS7853IPWR](#) [GP9301BXI-F10K-D1V10-SH](#) [GP9301BXI-F10K-N-SH](#) [GP9101-F50-C1H1-SW](#) [GP9301BXI-F5K-N-SW](#)  
[GP9101-F10K-N-SW](#) [GP9301BXI-F4K-D1V10-SH](#) [GP9301BXI-F1K-L5H2-SH](#) [LTC2484IDD#TRPBF](#) [AD9245BCPZRL7-20](#) [SSP1120](#)  
[ADS8332IBRGER](#) [HT7705ARWZ](#) [ADS9224RIRHBR](#) [ADC101S051CIMF](#) [AD7779ACPZ-RL](#) [AD7714YRUZ-REEL](#) [LTC2447IUHF#PBF](#)  
[AD9235BRUZRL7-20](#) [AD7888ARUZ-REEL](#) [AD7606BBSTZ-RL](#) [AD7998BRUZ-1REEL](#) [AD7276ARMZ-REEL](#) [AD7712ARZ-REEL](#)  
[AD7997BRUZ-1REEL](#) [LTC2348ILX-16#PBF](#) [AD2S1210BSTZ-RL7](#) [AD7711ARZ-REEL7](#) [AD7865ASZ-1REEL](#) [AD7923BRUZ-REEL](#)  
[AD7495ARZ-REEL7](#) [AD9629BCPZRL7-40](#) [AD7794CRUZ-REEL](#)