

500kbps RS-485 Transceivers with $\pm 20\text{kV}$ IEC ESD Protection

FEATURES

- High-Performance and Compliant with RS-485 TIA/EIA-485 Standard
- 3.0V to 5.5V Supply Voltage
- Bus I/O Protection
 - $\pm 20\text{kV}$ HBM ESD
 - $\pm 6\text{kV}$ IEC 6100-4-2 Contact Discharge
- -7V to +12V Common-Mode Input Voltage
- Up to 256 Nodes on the Same Bus (1/8 unit load)
- Low Stand-By Current: $< 5\mu\text{A}$
- Full Fail-safe Guarantees Known Receiver Output State
- Glitch-Free during Power on/Power off
- Short-Circuit Protection
- Over Temperature Protection
- $|V_{\text{OD}}| > 2.1\text{V}$ @ 5V Supply Voltage
- Operating Temperature Range: -40°C to $+125^\circ\text{C}$
- Packages: SOIC-8

DESCRIPTION

The RS1905 is a robust half-duplex RS-485 transceiver for industrial applications. The bus pins are immune to high levels of IEC Contact Discharge ESD events eliminating need of additional system level protection components.

The device operates from a single 3.3V to 5.0V supply. The RS1905 device can transmit and receive at data rate up to 500kbps. The wide common-mode voltage range and low input leakage on bus pins make RS1905 suitable for multi-point applications over long cable runs.

The RS1905 is available in industry standard 8-pin SOIC, package for drop-in compatibility. It operates over an ambient temperature range of -40°C to $+125^\circ\text{C}$.

Device Information (1)

PART NUMBER	PACKAGE	BODY SIZE(NOM)
RS1905	SOIC-8(SOP8)	4.90mm x 3.90mm

(1) For all available packages, see the orderable addendum at the end of the data sheet.

APPLICATIONS

- Electricity Meters (E-Meters)
- Inverters
- HVAC Systems
- Video Surveillance Systems
- Industrial Automation & Control

TYPICAL APPLICATION

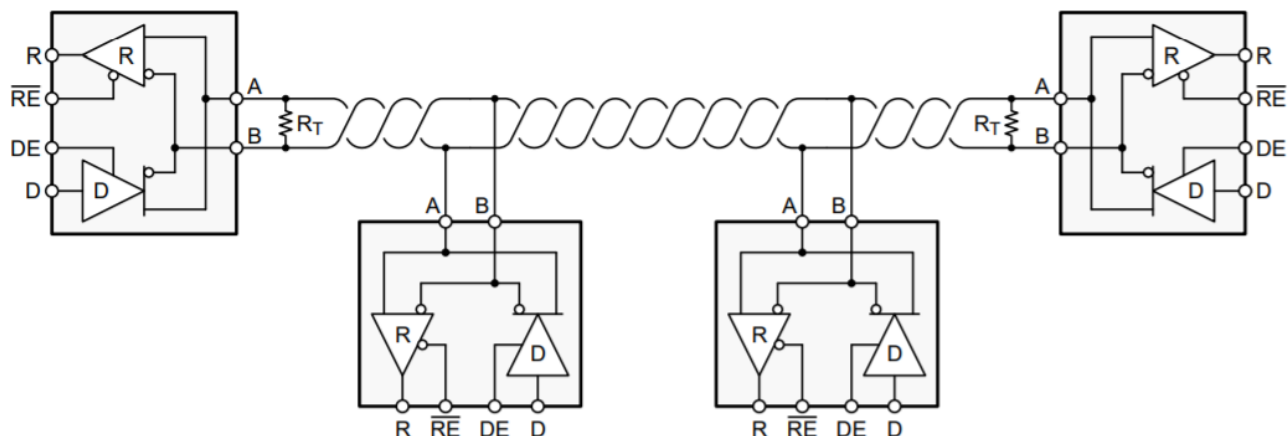

Revision History

Note: Page numbers for previous revisions may differ from page numbers in the current version.

VERSION	Change Date	Change Item
A.0	2022/11/11	Preliminary version completed.
A.1	2023/06/25	1、 Update Features description on Page1 2、 Change Parameter description on Page8
A.2	2023/09/21	1、 Update ESD Rating---Air Gap Contact on Page5.

Pin configuration and Functions (Top View)

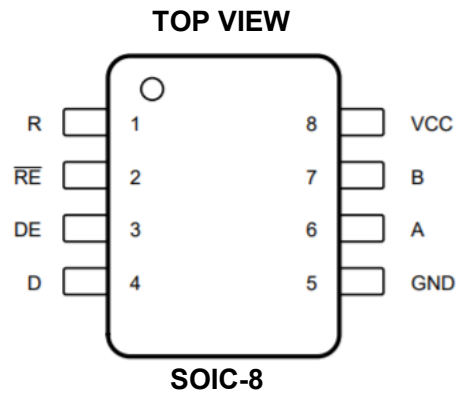

Pin Description

NAME	PIN	I/O	DESCRIPTION
	SOIC-8		
R	1	O	Receiver Data Output
/RE	2	I	Receiver Enable, Active low (with internal pull-up)
DE	3	I	Driver Enable, Active high (with internal pull-down)
D	4	I	Driver Data Input (with internal pull-up)
GND	5	Ground	Ground
A	6	I/O	Bus I/O port, A
B	7	I/O	Bus I/O port, B
VCC	8	Power	Power supply

PACKAGE/ORDERING INFORMATION

PRODUCT	ORDERING NUMBER	TEMPERATURE RANGE	PACKAGE LEAD	PACKAGE MARKING ^(1/2)	PACKAGE OPTION
RS1905	RS1905XK	-40°C ~+125°C	SOIC-8	RS1905	Tape and Reel,4000

NOTE:

- (1) There may be additional marking, which relates to the lot trace code information(data code and vendor code), the logo or the environmental category on the device.

SPECIFICATIONS

Absolute Maximum Ratings

over operating free-air temperature range (unless otherwise noted) ⁽¹⁾⁽²⁾

SYMBOL		MIN	MAX	UNIT
V _{CC}	Supply voltage	-0.5	7	V
V _{IO}	Bus A&B voltage	-8	13	V
	Logic input pin (/RE, DE, D)	-0.3	V _{CC} +0.3	V
	Logic output pin (R)	-0.3	V _{CC} +0.3	V
T _A	Operating temperature	-40	+125	°C
T _J	Junction temperature		150	
T _{stg}	Storage temperature	-65	150	

(1) Stresses beyond those listed under *Absolute Maximum Ratings* may cause permanent damage to the device. These are stress ratings only, and functional operation of the device at these or any other conditions beyond those indicated under *Recommended Operating Conditions* is not implied. Exposure to absolute-maximum-rated conditions for extended periods may affect device reliability.

(2) All voltages are with respect to the GND pin.

ESD Ratings

		VALUE	UNIT		
V _(ESD)	Electrostatic discharge	Human-body model (HBM), per ANSI/ESDA/JEDEC JS-001	Bus A & B	±20	kV
			Other pins	±8	kV
		Charge device model (CDM), per JESD22-C101	All pins	±2	kV
		Contact Discharge, per IEC 61000-4-2	Bus A & B	±6	kV
		Air Gap Discharge, per IEC 61000-4-2	Bus A & B	±6	kV

Notes:

- Per JEDEC document JEP155, 500V HBM allows safe manufacturing of standard ESD control process.
- Per JEDEC document JEP157, 250V CDM allows safe manufacturing of standard ESD control process.

Recommended Operating Conditions

over operating free-air temperature range (unless otherwise noted)

SYMBOL	PARAMETER	MIN	MAX	UNIT
V _{CC}	Supply voltage	3.0	5.5	V
V _{IN}	Bus input voltage	-7.0	12	V
V _{IH}	Input high voltage	2.0	V _{CC}	V
V _{IL}	Input low voltage	0	0.8	V
1/t _{UI}	Data rate		0.5	Mbps
R _L	Differential Load	54		Ω
T _A	Operating ambient temperature	-40	125	°C

Thermal Information

THERMAL METRIC		RS1905	UNIT
		SOIC-8	
		8 PINS	
$R_{\theta JA}$	Junction-to-ambient thermal resistance	124.7	°C/W
$R_{\theta JC (top)}$	Junction-to-case (top) thermal resistance	66.9	°C/W
$R_{\theta JB}$	Junction-to-board thermal resistance	67.9	°C/W
ψ_{JT}	Junction-to-top characterization parameter	19.2	°C/W
ψ_{JB}	Junction-to-board characterization parameter	67.2	°C/W
$R_{\theta JC (bot)}$	Junction-to-case (bottom) thermal resistance	N/A	°C/W

ELECTRICAL CHARACTERISTICS

at $T_A = 25^\circ\text{C}$, and $V_{CC} = 5\text{ V}$ (unless otherwise noted)

PARAMETER		TEST CONDITIONS	MIN	TYP	MAX	UNIT
Driver differential output voltage magnitude	V _{OD}	$R_L = 60\ \Omega, -7\text{ V} \leq V_{\text{test}} \leq 12$	1.5	3.6		V
		$R_L = 60\ \Omega, -7\text{ V} \leq V_{\text{test}} \leq 12, 4.5\text{ V} \leq V_{CC} \leq 5.5\text{ V}$	2.1	3.6		
		$R_L = 100\ \Omega, C_L = 50\text{ pF}$	2.0	4.2		
		$R_L = 54\ \Omega, C_L = 50\text{ pF}$	1.5	3.6		
Change in differential output voltage	$\Delta V_{OD} $	$R_L = 54\ \Omega$ or $100\ \Omega, C_L = 50\text{ pF}$	-50		50	mV
Common-mode output voltage	V _{OC}	$R_L = 54\ \Omega$ or $100\ \Omega, C_L = 50\text{ pF}$	1	V _{CC} /2	3.3	V
Steady-state commonmode output voltage	$\Delta V_{OC(SS)}$	$R_L = 54\ \Omega$ or $100\ \Omega, C_L = 50\text{ pF}$	-50		50	mV
Peak-to-peak commonmode output voltage	$\Delta V_{OC(PP)}$	$R_L = 54\ \Omega$ or $100\ \Omega, C_L = 50\text{ pF}$		450		mV
Short-circuit output current	I _{OS}	DE = V _{CC} , $-7\text{ V} \leq V_O \leq 12\text{ V}$		100	150	mA
Bus input current		DE=0, V _{CC} =0V or 5.5V, V _I =12V		75	125	μA
		DE=0, V _{CC} =0V or 5.5V, V _I =-7V	-100	-40		μA
Bus input impedance	R _I	V _A =-7V, V _B = 12V or V _A =12V, V _B =-7V	96			k Ω
Positive-going input threshold voltage	V _{TH+}			-110	-50	mV
Negative-going input threshold voltage	V _{TH-}		-200	-140		mV
Input hysteresis	V _{HYS}			30		mV
Output high voltage	V _{OH}	I _{OH} = -4mA	V _{CC} -0.5	V _{CC} -0.3		V
Output low voltage	V _{OL}	I _{OL} = 4mA		0.2	0.4	V
Output high-impedance current	I _{OZ}	V _O =0V or V _{CC} , /RE =V _{CC}	-1		+1	μA
Output short-circuit current	I _{OSR}	/RE=0, DE=0			95	mA
Input current (D, DE, RE)	I _{IN}		-5		+5	μA
Supply current (quiescent)	I _{CC}	Driver and receiver enabled /RE=0V, DE=V _{CC} , no load		0.95	1.5	mA
		Driver enabled, receiver disabled /RE=V _{CC} , DE=V _{CC} , no load		0.55	1.0	mA
		Driver disabled, receiver enabled /RE=0V, DE=0V, no load		0.5	0.9	mA
		Driver and receiver disabled /RE=V _{CC} , DE=0V, no load				5.0

Note:

- Under any condition, ensure that V_{TH+} is at least V_{HYS} higher than V_{TH-}.

SWITCHING CHARACTERISTICS

Over recommended operating conditions

PARAMETER	TEST CONDITIONS	MIN	TYP	MAX	UNIT	
Driver						
Differential output rise/fall time	t_r, t_f	$R_L = 54 \Omega, C_L = 50pF$		150	500	ns
Propagation delay	t_{PHL}, t_{PLH}	$R_L = 54 \Omega, C_L = 50pF$		100	250	ns
Pulse skew, $ t_{PHL} - t_{PLH} $	$t_{sk(P)}$	$R_L = 54 \Omega, C_L = 50pF$			10	ns
Disable time	t_{PHZ}, t_{PLZ}			10	30	ns
Enable time	t_{PZH}, t_{PZL}	/RE = 0V		300	800	ns
	t_{PZH}, t_{PZL}	/RE = VCC		6	12	μs
Receiver						
Differential output rise/fall time	t_r, t_f	$C_L = 15pF$		10	20	ns
Propagation delay	t_{PHL}, t_{PLH}	$C_L = 15pF$		50	100	ns
Pulse skew, $ t_{PHL} - t_{PLH} $	$t_{sk(P)}$	$C_L = 15pF$			7	ns
Disable time	t_{PHZ}, t_{PLZ}			30	60	ns
Enable time	t_{PZH}, t_{PZL}	DE = VCC		50	100	ns
Output high voltage	t_{PZH}, t_{PZL}	DE = 0		6	12	μs

Note:

1. C_L includes external circuit (fixture and instrumentation etc.) capacitance.

TYPICAL CHARACTERISTICS

At $T_A = 25^\circ\text{C}$, $V_{IN} = 5\text{V}$ power supply, Min/Max specs are over recommended operating conditions unless otherwise specified

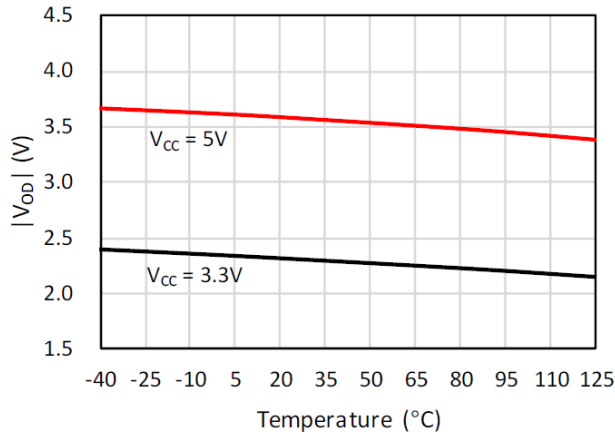

Figure 1. Differential Output Voltage vs. Temperature ($R_L = 54\Omega$)

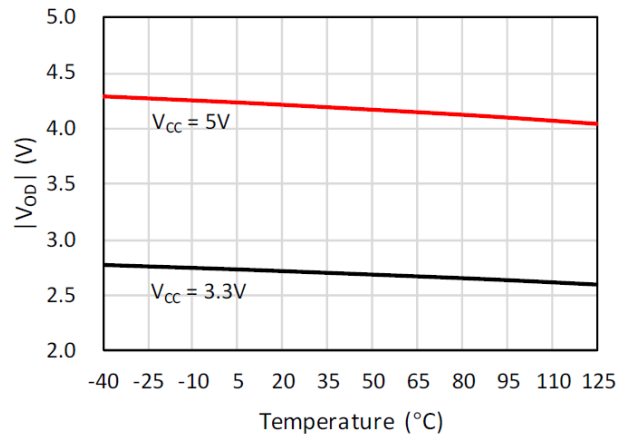

Figure 2. Differential Output Voltage vs. Temperature ($R_L = 100\Omega$)

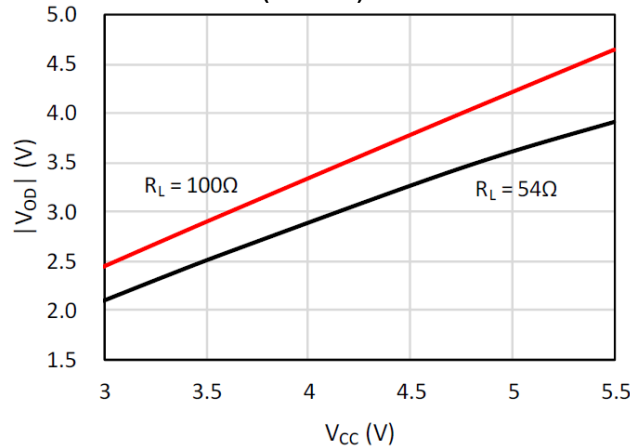

Figure 3. Differential Output Voltage vs. Supply Voltage

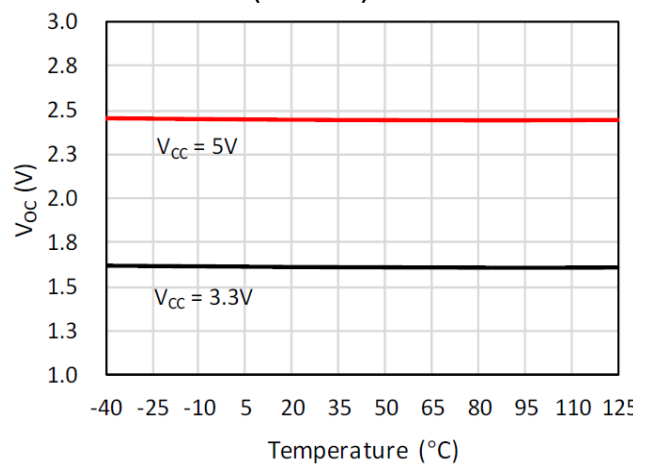

Figure 4. Common-mode Output Voltage vs. Temperature

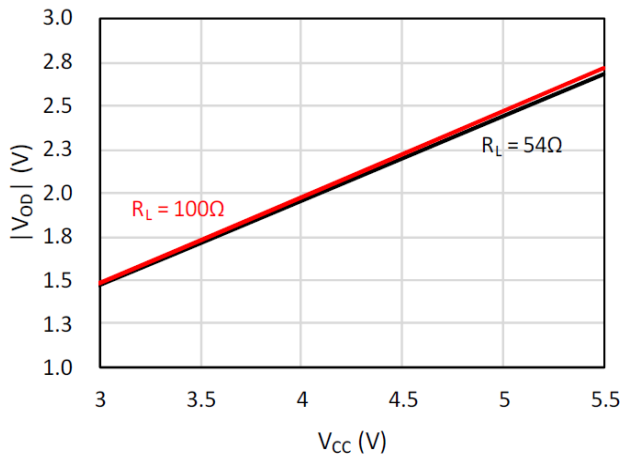

Figure 5. Common Output Voltage vs. Supply voltage

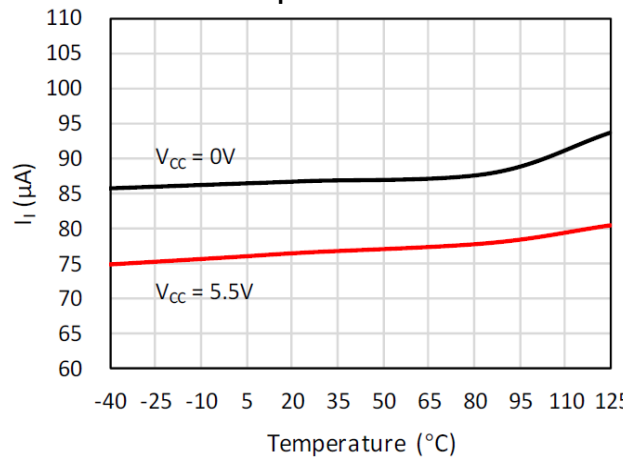

Figure 6. Bus Input Current vs. Temperature

TYPICAL CHARACTERISTICS

At $T_A = 25^\circ\text{C}$, $V_{IN} = 5\text{V}$ power supply, Min/Max specs are over recommended operating conditions unless otherwise specified.

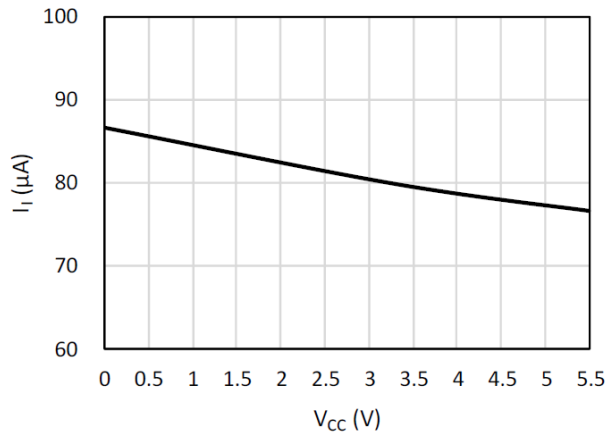

Figure 7. Bus Input Current vs. Supply Voltage, $V_i=12\text{V}$

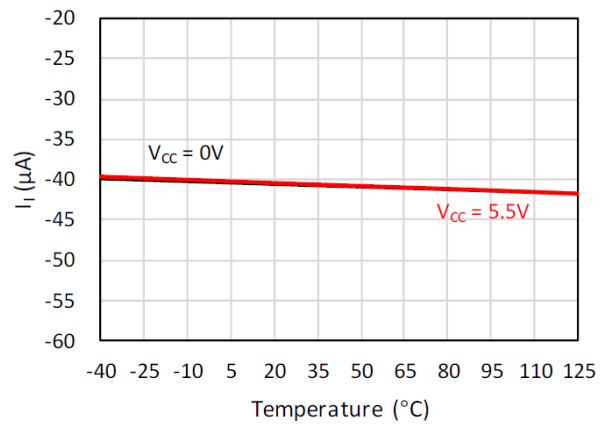

Figure 8. Bus Input Current vs. Temperature, $V_i=-7\text{V}$

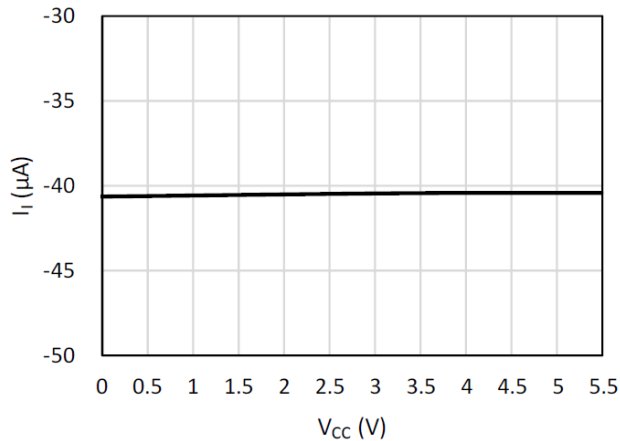

Figure 9. Bus Input Current vs. Supply Voltage, $V_i=-7\text{V}$

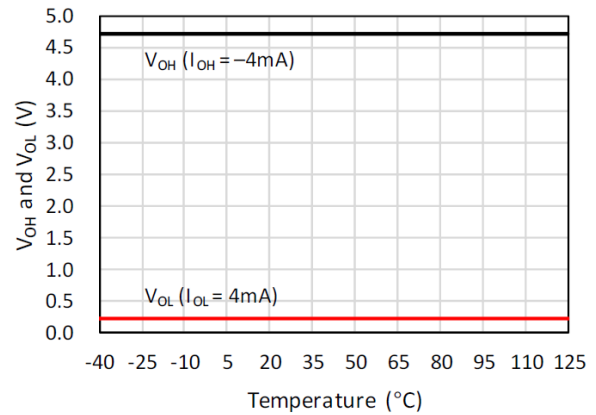

Figure 10. Receiver Output Low vs. Temperature

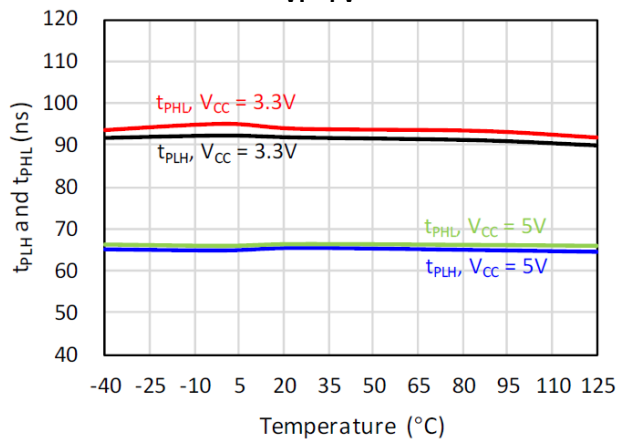

Figure 11. Driver Propagation Delay vs. Temperature

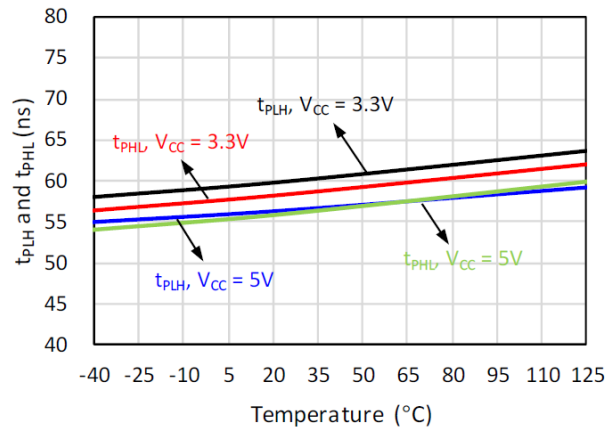

Figure 12. Receiver Propagation Delay vs. Temperature

TYPICAL CHARACTERISTICS

At $T_A = 25^\circ\text{C}$, $V_{IN} = 5\text{V}$ power supply, Min/Max specs are over recommended operating conditions unless otherwise specified.

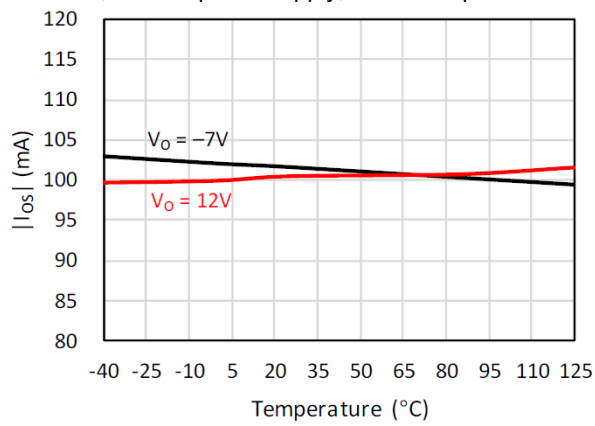

Figure 13. Driver Output Short Current vs. Temperature

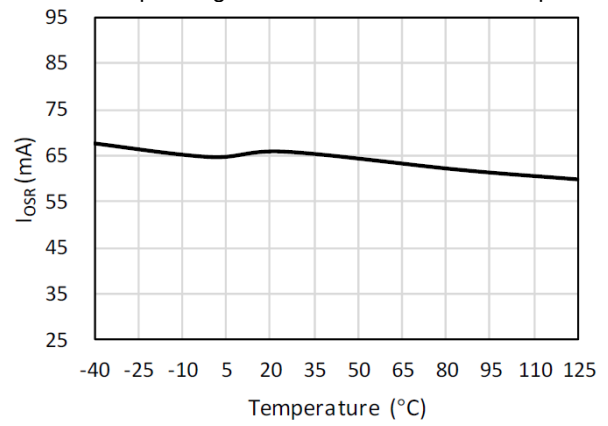

Figure 14. Propagation Delay of Receiver

Parameter Measurement Information

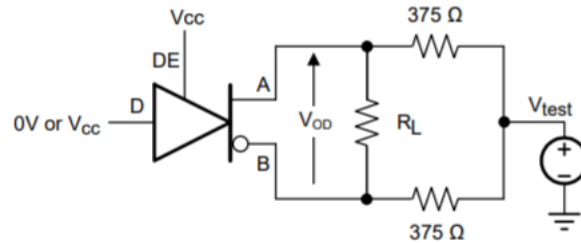

Figure 15 Measurement of Driver Differential Output Voltage With Common-Mode Load

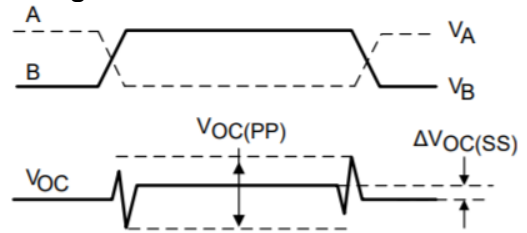
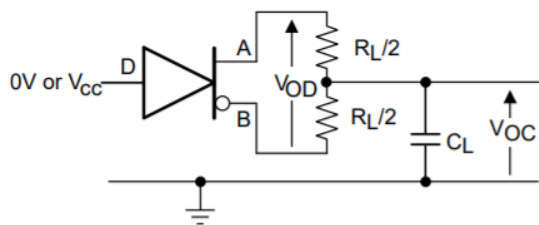

Figure 16 Measurement of Driver Differential and Common-Mode Output With RS-485 Load

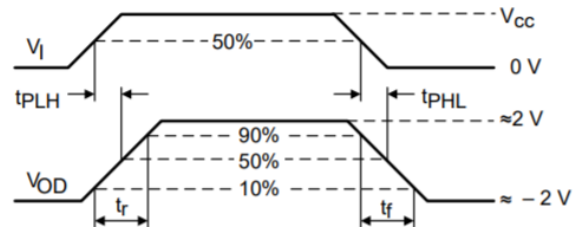
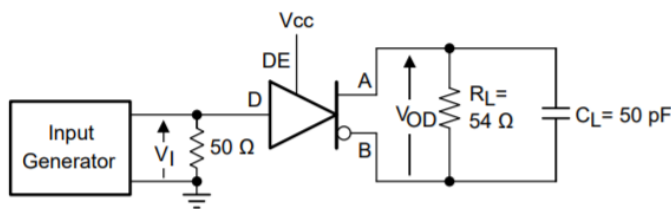

Figure 17 Measurement of Driver Differential Output Rise and Fall Times and Propagation Delays

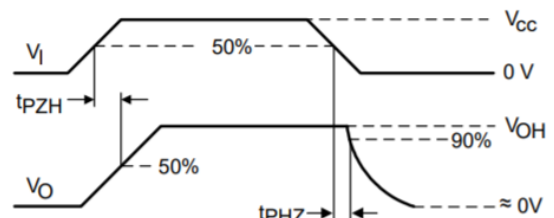
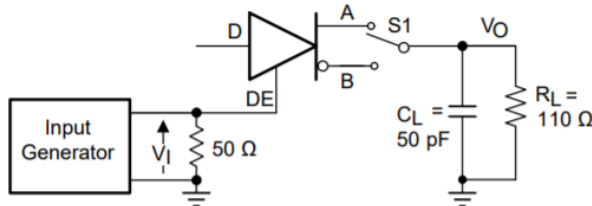

Figure 18 Measurement of Driver Enable and Disable Times With Active High Output and Pull Down Load

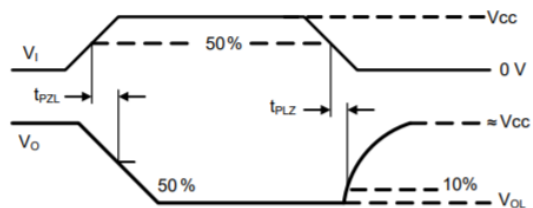
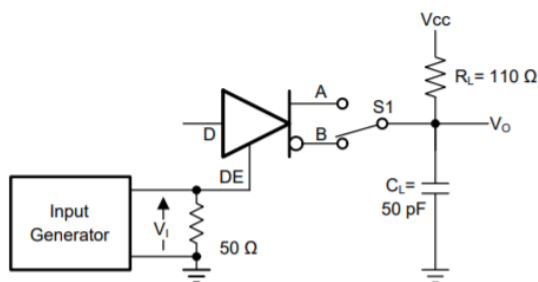

Figure 19 Measurement of Driver Enable and Disable Times With Active Low Output and Pull-Up Load

Detailed Description

Overview

The RS1905 is a low-power, half-duplex RS-485 transceiver suitable for data transmission up to 500 kbps..

Functional Block Diagram

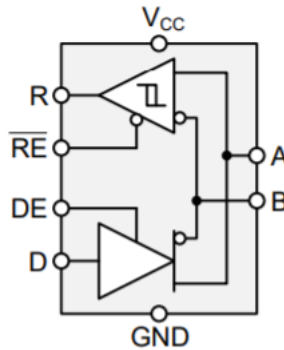

Feature Description

Internal ESD protection circuits protect the transceiver against Electrostatic Discharges (ESD) according to IEC 61000-4-2 of up to ± 6 kV (Contact Discharge), ± 20 kV (Human-body model). The RS1905 provides internal biasing of the receiver input thresholds in combination with large input threshold hysteresis. With a positive input threshold of $V_{IT+} = -50$ mV and an input hysteresis of $V_{HYS} = 50$ mV, the receiver output remains logic high under a bus-idle or bus-short conditions without the need for external failsafe biasing resistors. Device operation is specified over a wide temperature range from -40°C to 125°C .

Device Functional Modes

When the driver enable pin, DE, is logic high, the differential outputs A and B follow the logic states at data input D. A logic high at D causes A to turn high and B to turn low. In this case, the differential output voltage defined as $V_{OD} = V_A - V_B$ is positive. When D is low, the output states reverse, B turns high, A becomes low, and V_{OD} is negative. When DE is low, both outputs turn high-impedance. In this condition the logic state at D is irrelevant. The DE pin has an internal pull-down resistor to ground, thus when left open the driver is disabled (high-impedance) by default. The D pin has an internal pull-up resistor to V_{CC} , thus, when left open while the driver is enabled, output A turns high and B turns low.

Table 1. Driver Function Table

Input	Enable	Output		Function
D	DE	A	B	
H	H	H	L	Actively drive bus high
L	H	L	H	Actively drive bus low
X	L	Z	Z	Driver disabled
X	OPEN	Z	Z	Driver disabled by default
OPEN	H	H	L	Actively drive bus high by default

Note:

X means don't care,
Z means high resistance

When the receiver enable pin, \overline{RE} , is logic low, the receiver is enabled. When the differential input voltage defined as $V_{ID} = V_A - V_B$ is positive and higher than the positive input threshold, V_{IT+} , the receiver output, R, turns high. When V_{ID} is negative and lower than the negative input threshold, V_{IT-} , the receiver output, R, turns low. If V_{ID} is between V_{IT+} and V_{IT-} the output is indeterminate. When \overline{RE} is logic high or left open, the receiver output is high-impedance and the magnitude and polarity of V_{ID} are irrelevant. Internal biasing of the receiver inputs causes the output to go failsafe-high when the transceiver is disconnected from the bus (open-circuit), the bus lines are shorted (short-circuit), or the bus is not actively driven (idle bus).

Table 2. Receiver Function Table

Differential Input	Enable	Output	Function
$V_{ID} = V_A - V_B$	\overline{RE}	R	
$V_{IT+} < V_{ID}$	L	H	Receive valid bus high
$V_{IT-} < V_{ID} < V_{IT+}$	L	Indeterminate	Indeterminate bus state
$V_{ID} < V_{IT-}$	L	L	Receive valid bus low
X	H	Z	Receiver disabled
X	OPEN	Z	Receiver disabled by default
Open-circuit bus	L	H	Fail-safe high output
Short-circuit bus	L	H	Fail-safe high output
Idle(terminated) bus	L	H	Fail-safe high output

Note:

X means don't care

Z means high resistance

Application Information

The RS1905 is a half-duplex RS-485/RS-422 transceiver commonly used for asynchronous data transmissions. The driver and receiver enable pins allow for the configuration of different operating modes.

Typical Application

An RS-485 bus consists of multiple transceivers connecting in parallel to a bus cable. To eliminate line reflections, each cable end is terminated with a termination resistor, R_T , whose value matches the characteristic impedance, Z_0 , of the cable. This method, known as parallel termination, allows for higher data rates over longer cable length.

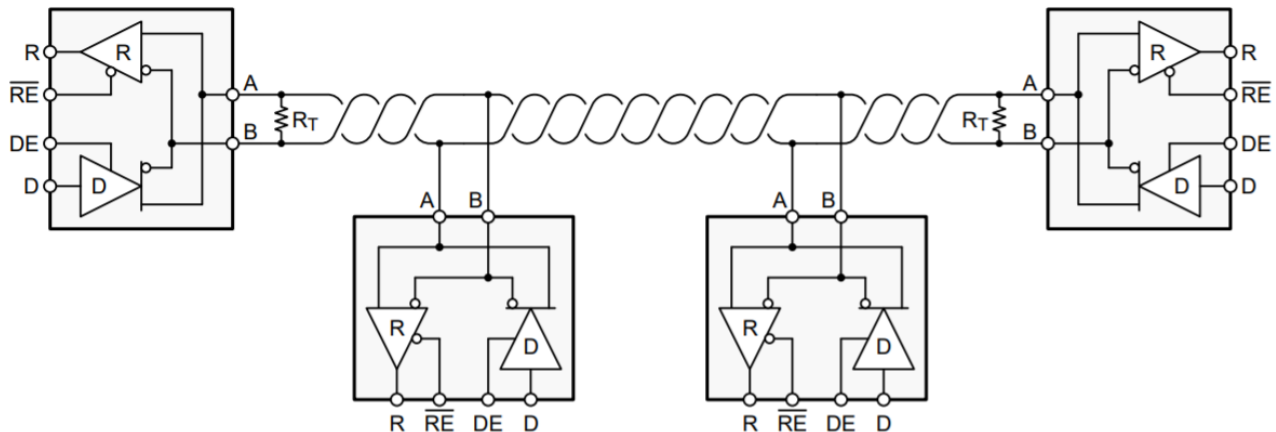

Figure 20. Typical RS-485 Network With Half-Duplex Transceivers

Supply Voltage Design Requirements

In order to ensure the reliability of data transmission and power supply, it is recommended to place decoupling capacitors from 100nF to 220nF as close as possible to the VCC pin of each transceiver.

Layout

Layout Guidelines

Robust and reliable bus node design often requires the use of external transient protection devices in order to protect against surge transients that may occur in industrial environments. Since these transients have a wide frequency bandwidth (from approximately 3 MHz to 300 MHz), high-frequency layout techniques should be applied during PCB design.

1. Place the protection circuitry close to the bus connector to prevent noise transients from propagating across the board.
2. Use VCC and ground planes to provide low inductance. Note that high-frequency currents tend to follow the path of least impedance and not the path of least resistance.
3. Design the protection components into the direction of the signal path. Do not force the transient currents to divert from the signal path to reach the protection device.
4. Apply 100-nF to 220-nF bypass capacitors as close as possible to the VCC pins of transceiver, UART and/or controller ICs on the board.
5. Use at least two vias for VCC and ground connections of bypass capacitors and protection devices to minimize effective via inductance.
6. Use 1-k Ω to 10-k Ω pullup and pulldown resistors for enable lines to limit noise currents in these lines during transient events.
7. Insert pulse-proof resistors into the A and B bus lines if the TVS clamping voltage is higher than the specified maximum voltage of the transceiver bus pins. These resistors limit the residual clamping current into the transceiver and prevent it from latching up.
8. While pure TVS protection is sufficient for surge transients up to 1 kV, higher transients require metal-oxide varistors (MOVs) which reduce the transients to a few hundred volts of clamping voltage, and transient blocking units (TBUs) that limit transient current to less than 1 mA.

Layout Example

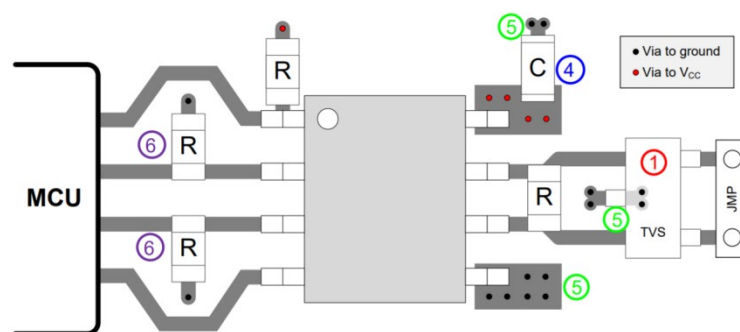
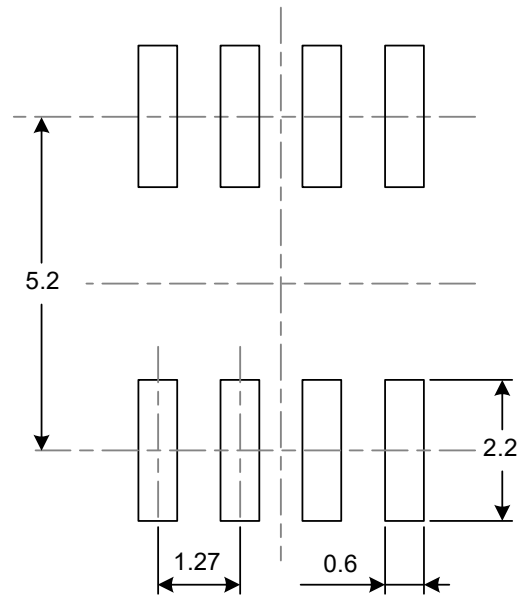
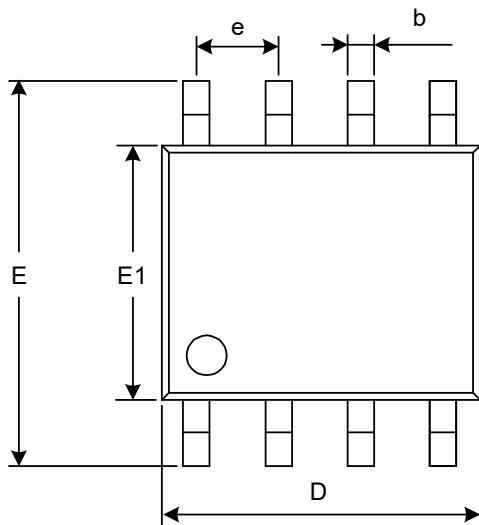
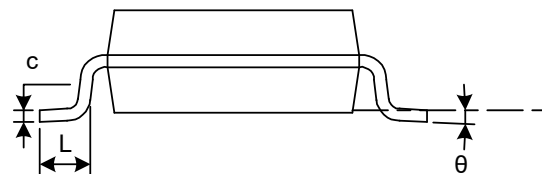
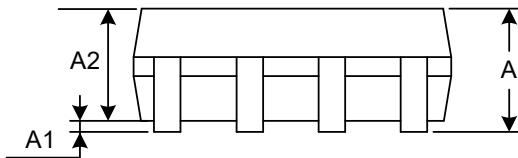
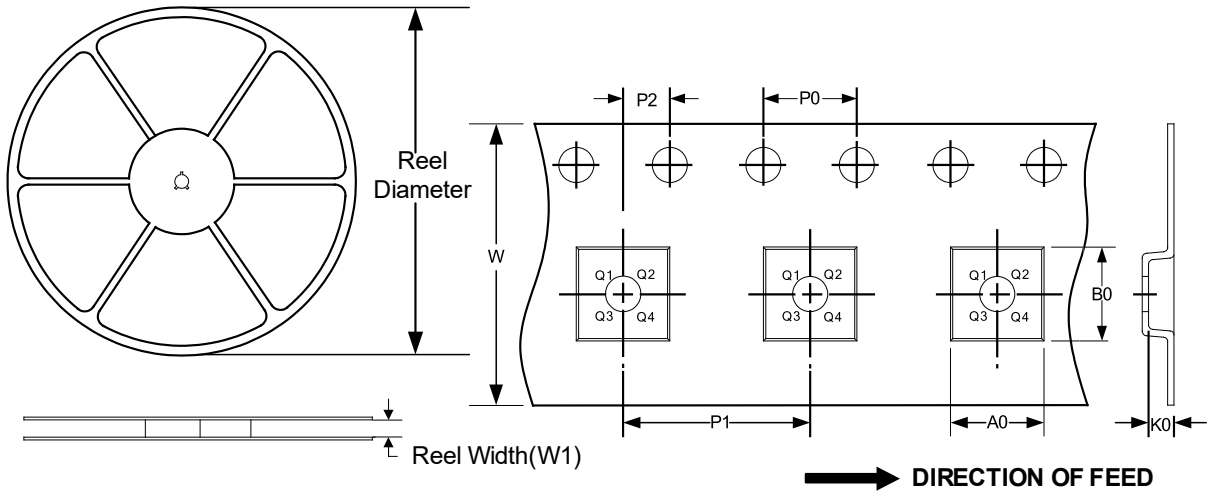

Figure 21. Layout Example

PACKAGE OUTLINE DIMENSIONS
SOIC-8

RECOMMENDED LAND PATTERN (Unit: mm)

Symbol	Dimensions In Millimeters		Dimensions In Inches	
	Min	Max	Min	Max
A	1.350	1.750	0.053	0.069
A1	0.100	0.250	0.004	0.010
A2	1.350	1.550	0.053	0.061
b	0.330	0.510	0.013	0.020
c	0.170	0.250	0.007	0.010
D	4.800	5.000	0.189	0.197
e	1.270 (BSC)		0.050 (BSC)	
E	5.800	6.200	0.228	0.244
E1	3.800	4.000	0.150	0.157
L	0.400	1.270	0.016	0.050
θ	0°	8°	0°	8°

TAPE AND REEL INFORMATION
REEL DIMENSIONS
TAPE DIMENSION

NOTE: The picture is only for reference. Please make the object as the standard.

KEY PARAMETER LIST OF TAPE AND REEL

Package Type	Reel Diameter	Reel Width (mm)	A0 (mm)	B0 (mm)	K0 (mm)	P0 (mm)	P1 (mm)	P2 (mm)	W (mm)	Pin1 Quadrant
SOIC-8	13"	12.4	6.40	5.40	2.10	4.0	8.0	2.0	12.0	Q1

X-ON Electronics

Largest Supplier of Electrical and Electronic Components

Click to view similar products for [RS-422/RS-485 Interface IC category](#):

Click to view products by [RUNIC manufacturer](#):

Other Similar products are found below :

[SP3494CN-L/TR](#) [ISL4486IBZ-T](#) [ISL4491EIB](#) [ISL4491EIBZ-T](#) [ISL81483IB](#) [ISL83086EIB](#) [ISL83088EIB](#) [ISL83488IB](#) [ISL8483EIB](#)
[ISL8487EIB](#) [ISL8489EIB](#) [ISL8491IP](#) [ADM489AN](#) [CA-IF4820HM](#) [CS48505M](#) [CS485S](#) [CS817x22HS](#) [MAX485ESA-MS](#) [MAX3085](#)
[ADM3485EARZ](#) [SP3485EEN](#) [TP3485ES8](#) [MAX3485ESA](#) [ST3485EBDR](#) [ADM485ARZ](#) [CA-IF4820HD](#) [CA-IF1042S-Q1](#) [CA-IF1021D-Q1](#)
[CS48520D](#) [SN65HVD78EIMM/TR](#) [HGX3085ECMM/TR](#) [SP3085EIMM/TR](#) [HGX3085EIMM/TR](#) [SN65HVD72EIMM/TR](#) [HGX485EIN](#)
[RS1905XK](#) [SIT1044QTK](#) [THVD1420DR](#) [MAX3490EESA+T](#) [UM3483EESA](#) [HD588L](#) [HD568N](#) [HD688ADR](#) [CA-IS3080WX](#) [CA-](#)
[IS3086WX](#) [CS817x20HS](#) [CA-IF1044S-Q1](#) [CA-IF4820FS](#) [CA-IF4850HS](#) [GM3490E](#)