

# RS1G34 Single Buffer Gate

## 1 FEATURES

- **Operating Voltage Range:** 1.65V to 5.5V
- **Low Power Consumption:** 1µA (Max)
- **Operating Temperature Range:** -40°C to +125°C
- **Inputs Accept Voltage to 5.5V**
- **High Output Drive:** ±24mA at V<sub>CC</sub>=3.0V
- **I<sub>off</sub> Supports Partial-Power-Down Mode Operation**
- **Micro SIZE PACKAGES:** SOT23-5, SOT353(SC70-5)

## 2 APPLICATIONS

- AC Receiver
- Blu-ray Players and Home Theaters
- Desktops or Notebook PCs
- Digital Video Cameras (DVC)
- Mobile Phones
- Personal Navigation Device (GPS)
- Portable Media Player



## 3 DESCRIPTIONS

The RS1G34 Single buffer gate is designed for 1.65V to 5.5V V<sub>CC</sub> operation.

The RS1G34 device performs the Boolean function Y=A in positive logic.

The CMOS device has high output drive while maintaining low static power dissipation over a broad V<sub>CC</sub> operating range.

The RS1G34 is available in Green SOT23-5 and SOT353(SC70-5) packages. It operates over an ambient temperature range of -40°C to +125°C.

### Device Information (1)

| PART NUMBER | PACKAGE            | BODY SIZE (NOM) |
|-------------|--------------------|-----------------|
| RS1G34      | SOT23-5(5)         | 2.92mm×1.60mm   |
|             | SOT353 (SC70-5)(5) | 2.10mm×1.25mm   |

(1) For all available packages, see the orderable addendum at the end of the data sheet.

## 4 FUNCTION TABLE

| INPUT | OUTPUT |
|-------|--------|
| A     | Y      |
| H     | H      |
| L     | L      |

Y=A

H=High Voltage Level

L=Low Voltage Level

## Table of Contents

|  |    |
|--|----|
| <b>1 FEATURES</b> .....                                    | 1  |
| <b>2 APPLICATIONS</b> .....                                | 1  |
| <b>3 DESCRIPTIONS</b> .....                                | 1  |
| <b>4 FUNCTION TABLE</b> .....                              | 1  |
| <b>5 Revision History</b> .....                            | 3  |
| <b>6 PACKAGE/ORDERING INFORMATION</b> <sup>(1)</sup> ..... | 4  |
| <b>7 PIN CONFIGURATIONS</b> .....                          | 5  |
| <b>8 SPECIFICATIONS</b> .....                              | 6  |
| 8.1 Absolute Maximum Ratings <sup>(1)</sup> .....          | 6  |
| 8.2 ESD Ratings .....                                      | 6  |
| <b>9 ELECTRICAL CHARACTERISTICS</b> .....                  | 7  |
| 9.1 Recommended Operating Conditions .....                 | 7  |
| 9.2 DC Characteristics .....                               | 8  |
| 9.3 AC Characteristics .....                               | 8  |
| <b>10 Parameter Measurement Information</b> .....          | 9  |
| <b>11 Detailed Description</b> .....                       | 10 |
| 11.1 Overview .....  | 10 |
| 11.2 Functional Block Diagram .....                        | 10 |
| 11.3 Feature Description .....                             | 10 |
| <b>12 Application and Implementation</b> .....             | 11 |
| 12.1 Application Information .....                         | 11 |
| 12.2 Design Requirements .....                             | 11 |
| <b>13 Power Supply Recommendations</b> .....               | 11 |
| <b>14 Layout</b> .....                                     | 12 |
| 14.1 Layout Guidelines .....                               | 12 |
| 14.2 Layout Example .....                                  | 12 |
| <b>15 PACKAGE OUTLINE DIMENSIONS</b> .....                 | 13 |
| <b>16 TAPE AND REEL INFORMATION</b> .....                  | 15 |

## 5 Revision History

Note: Page numbers for previous revisions may differ from page numbers in the current version.

| Version | Change Date | Change Item               |
|---------|-------------|---------------------------|
| A.1     | 2023/01/10  | Initial version completed |

**6 PACKAGE/ORDERING INFORMATION <sup>(1)</sup>**

| PRODUCT | ORDERING NUMBER | TEMPERATURE RANGE | PACKAGE LEAD   | PACKAGE MARKING <sup>(2)</sup> | PACKAGE OPTION     |
|---------|-----------------|-------------------|----------------|--------------------------------|--------------------|
| RS1G34  | RS1G34XC5       | -40°C ~+125°C     | SC70-5(SOT353) | 1G34                           | Tape and Reel,3000 |
|         | RS1G34XF5       | -40°C ~+125°C     | SOT23-5        | 1G34                           | Tape and Reel,3000 |

## NOTE:

- (1) This information is the most current data available for the designated devices. This data is subject to change without notice and revision of this document. For browser-based versions of this data sheet, refer to the right-hand navigation.
- (2) There may be additional marking, which relates to the lot trace code information (data code and vendor code), the logo or the environmental category on the device.

## 7 PIN CONFIGURATIONS

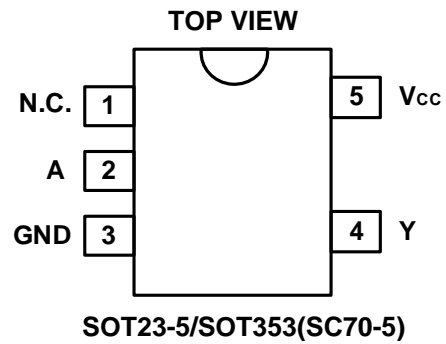

### PIN DESCRIPTION

| PIN                           | NAME                | I/O <sup>(1)</sup> | FUNCTION      |
|-------------------------------|---------------------|--------------------|---------------|
| <b>SOT23-5/SOT353(SC70-5)</b> |                     |                    |               |
| 1                             | N.C. <sup>(2)</sup> | -                  | Not connected |
| 2                             | A                   | I                  | Input         |
| 3                             | GND                 | P                  | Ground        |
| 4                             | Y                   | O                  | Output        |
| 5                             | V <sub>CC</sub>     | P                  | Power pin     |

(1) I=input, O=output, P=power.

(2) There is no internal connection. Typically, GND is the recommended connection to a heat spreading plane.

## 8 SPECIFICATIONS

### 8.1 Absolute Maximum Ratings <sup>(1)</sup>

over operating free-air temperature range (unless otherwise noted) <sup>(1)</sup> <sup>(2)</sup>

|                  |   | MIN               | MAX                  | UNIT |
|------------------|---|-------------------|----------------------|------|
| V <sub>CC</sub>  | Supply voltage range  | -0.5              | 6.5                  | V    |
| V <sub>I</sub>   | Input voltage range <sup>(2)</sup>  | -0.5              | 6.5                  | V    |
| V <sub>O</sub>   | Voltage range applied to any output in the high-impedance or power-off state <sup>(2)</sup> | -0.5              | 6.5                  | V    |
| V <sub>O</sub>   | Voltage range applied to any output in the high or low state <sup>(2)</sup> <sup>(3)</sup>  | -0.5              | V <sub>CC</sub> +0.5 | V    |
| I <sub>IK</sub>  | Input clamp current   | V <sub>I</sub> <0 | -50                  | mA   |
| I <sub>OK</sub>  | Output clamp current  | V <sub>O</sub> <0 | -50                  | mA   |
| I <sub>O</sub>   | Continuous output current   |                   | ±50                  | mA   |
|                  | Continuous current through V <sub>CC</sub> or GND   |                   | ±100                 | mA   |
| θ <sub>JA</sub>  | Package thermal impedance <sup>(4)</sup>  | SOT23-5           | 230                  | °C/W |
|                  |   | SOT353/(SC70-5)   | 376                  |      |
| T <sub>J</sub>   | Junction temperature <sup>(5)</sup>   | -65               | 150                  | °C   |
| T <sub>stg</sub> | Storage temperature   | -65               | 150                  | °C   |

- (1) Stresses beyond those listed under *Absolute Maximum Ratings* may cause permanent damage to the device. These are stress ratings only, and functional operation of the device at these or any other conditions beyond those indicated under *Recommended Operating Conditions* is not implied. Exposure to absolute-maximum-rated conditions for extended periods may affect device reliability.
- (2) The input and output negative-voltage ratings may be exceeded if the input and output current ratings are observed.
- (3) The value of V<sub>CC</sub> is provided in the *Recommended Operating Conditions table*.
- (4) The package thermal impedance is calculated in accordance with JESD-51.
- (5) The maximum power dissipation is a function of T<sub>J(MAX)</sub>, R<sub>θJA</sub>, and T<sub>A</sub>. The maximum allowable power dissipation at any ambient temperature is P<sub>D</sub> = (T<sub>J(MAX)</sub> - T<sub>A</sub>) / R<sub>θJA</sub>. All numbers apply for packages soldered directly onto a PCB.

### 8.2 ESD Ratings

The following ESD information is provided for handling of ESD-sensitive devices in an ESD protected area only.

|  |   | VALUE | UNIT |
|--|---|-------|------|
| V <sub>(ESD)</sub> Electrostatic discharge | Human-body model (HBM), per ANSI/ESDA/JEDEC JS-001 <sup>(1)</sup>     | ±4000 | V    |
|  | Charged-device model (CDM), per ANSI/ESDA/JEDEC JS-002 <sup>(2)</sup> | ±1500 | V    |
|  | Machine model (MM)  | ±200  | V    |

- (1) JEDEC document JEP155 states that 500 V HBM allows safe manufacturing with a standard ESD control process.
- (2) JEDEC document JEP157 states that 250 V CDM allows safe manufacturing with a standard ESD control process.



#### ESD SENSITIVITY CAUTION

ESD damage can range from subtle performance degradation to complete device failure. Precision integrated circuits may be more susceptible to damage because very small parametric changes could cause the device not to meet its published specifications.

## 9 ELECTRICAL CHARACTERISTICS

over recommended operating free-air temperature range (TYP values are at  $T_A = +25^\circ\text{C}$ , Full= $-40^\circ\text{C}$  to  $125^\circ\text{C}$ , unless otherwise noted.) <sup>(1)</sup>

### 9.1 Recommended Operating Conditions

| PARAMETER                     | SYMBOL              | TEST CONDITIONS  | MIN                  | MAX                  | UNIT             |
|-------------------------------|---------------------|--|----------------------|----------------------|------------------|
| Supply voltage                | $V_{CC}$            | Operating  | 1.65                 | 5.5                  | V                |
|                               |                     | Data retention only  | 1.5                  |                      |                  |
| High-level input voltage      | $V_{IH}$            | $V_{CC}=1.65\text{V to }1.95\text{V}$                              | $0.65 \times V_{CC}$ |                      | V                |
|                               |                     | $V_{CC}=2.3\text{V to }2.7\text{V}$                                | 1.7                  |                      |                  |
|                               |                     | $V_{CC}=3\text{V to }3.6\text{V}$                                  | 2                    |                      |                  |
|                               |                     | $V_{CC}=4.5\text{V to }5.5\text{V}$                                | $0.7 \times V_{CC}$  |                      |                  |
| Low-level input voltage       | $V_{IL}$            | $V_{CC}=1.65\text{V to }1.95\text{V}$                              |                      | $0.35 \times V_{CC}$ | V                |
|                               |                     | $V_{CC}=2.3\text{V to }2.7\text{V}$                                |                      | 0.7                  |                  |
|                               |                     | $V_{CC}=3\text{V to }3.6\text{V}$                                  |                      | 0.8                  |                  |
|                               |                     | $V_{CC}=4.5\text{V to }5.5\text{V}$                                |                      | $0.3 \times V_{CC}$  |                  |
| Input voltage                 | $V_I$               |  | 0                    | 5.5                  | V                |
| Output voltage                | $V_O$               |  | 0                    | $V_{CC}$             | V                |
| Input transition rise or fall | $\Delta t/\Delta v$ | $V_{CC}=1.8\text{V} \pm 0.15\text{V}, 2.5\text{V} \pm 0.2\text{V}$ |                      | 20                   | ns/V             |
|                               |                     | $V_{CC}=3.3\text{V} \pm 0.3\text{V}$                               |                      | 10                   |                  |
|                               |                     | $V_{CC}=5\text{V} \pm 0.5\text{V}$                                 |                      | 5                    |                  |
| Operating temperature         | $T_A$               |  | -40                  | +125                 | $^\circ\text{C}$ |

(1) All unused inputs of the device must be held at  $V_{CC}$  or GND to ensure proper device operation.

## 9.2 DC Characteristics

| PARAMETER                          |          | TEST CONDITIONS   | V <sub>CC</sub> | TEMP  | MIN <sup>(2)</sup>   | TYP <sup>(3)</sup> | MAX <sup>(2)</sup> | UNIT |
|------------------------------------|----------|---|-----------------|-------|----------------------|--------------------|--------------------|------|
| V <sub>OH</sub>                    |          | I <sub>OH</sub> = -100μA  | 1.65V to 5.5V   | Full  | V <sub>CC</sub> -0.1 |                    |                    | V    |
|                                    |          | I <sub>OH</sub> = -4mA  | 1.65V           |       | 1.2                  |                    |                    |      |
|                                    |          | I <sub>OH</sub> = -8mA  | 2.3V            |       | 1.9                  |                    |                    |      |
|                                    |          | I <sub>OH</sub> = -16mA   | 3V              |       | 2.4                  |                    |                    |      |
|                                    |          | I <sub>OH</sub> = -24mA   |                 |       | 2.3                  |                    |                    |      |
|                                    |          | I <sub>OH</sub> = -32mA   | 4.5V            |       | 3.8                  |                    |                    |      |
| V <sub>OL</sub>                    |          | I <sub>OL</sub> = 100μA   | 1.65V to 5.5V   | Full  |                      |                    | 0.1                | V    |
|                                    |          | I <sub>OL</sub> = 4mA   | 1.65V           |       |                      |                    | 0.45               |      |
|                                    |          | I <sub>OL</sub> = 8mA   | 2.3V            |       |                      |                    | 0.3                |      |
|                                    |          | I <sub>OL</sub> = 16mA  | 3V              |       |                      |                    | 0.4                |      |
|                                    |          | I <sub>OL</sub> = 24mA  |                 |       |                      |                    | 0.55               |      |
|                                    |          | I <sub>OL</sub> = 32mA  | 4.5V            |       |                      |                    | 0.55               |      |
| I <sub>I</sub>                     | A inputs | V <sub>I</sub> =5.5V or GND   | 0V to 5.5V      | +25°C |                      | ±0.1               | ±1                 | μA   |
|                                    |          |   |                 | Full  |                      |                    | ±5                 |      |
| I <sub>off</sub>                   |          | V <sub>I</sub> or V <sub>O</sub> =5.5V  | 0               | +25°C |                      | ±0.1               | ±1                 | μA   |
|                                    |          |   |                 | Full  |                      |                    | ±10                |      |
| I <sub>CC</sub>                    |          | V <sub>I</sub> =5.5V or GND, I <sub>O</sub> =0                                | 1.65V to 5.5V   | +25°C |                      | 0.1                | 1                  | μA   |
|                                    |          |   |                 | Full  |                      |                    | 10                 |      |
| ΔI <sub>CC</sub>                   |          | One input at V <sub>CC</sub> -0.6V,<br>Other inputs at V <sub>CC</sub> or GND | 3V to 5.5V      | Full  |                      |                    | 500                | μA   |
| C <sub>i</sub> (Input Capacitance) |          | V <sub>I</sub> = V <sub>CC</sub> or GND                                       | 3.3V            | +25°C |                      | 4                  |                    | pF   |

(1) All unused inputs of the device must be held at V<sub>CC</sub> or GND to ensure proper device operation.

(2) Limits are 100% production tested at 25°C. Limits over the operating temperature range are ensured through correlations using statistical quality control (SQC) method.

(3) Typical values represent the most likely parametric norm as determined at the time of characterization. Actual typical values may vary over time and will also depend on the application and configuration.

## 9.3 AC Characteristics

| PARAMETER                     | SYMBOL          | TEST CONDITIONS             |  | MIN <sup>(2)</sup> | TYP <sup>(3)</sup> | MAX <sup>(2)</sup> | UNIT |
|-------------------------------|-----------------|-----------------------------|--|--------------------|--------------------|--------------------|------|
| Propagation Delay             | t <sub>pd</sub> | V <sub>CC</sub> =1.8V±0.15V | C <sub>L</sub> =30pF, R <sub>L</sub> =1kΩ  |                    | 13.2               |                    | ns   |
|                               |                 | V <sub>CC</sub> =2.5V±0.2V  | C <sub>L</sub> =30pF, R <sub>L</sub> =500Ω |                    | 5.2                |                    |      |
|                               |                 | V <sub>CC</sub> =3.3V±0.3V  | C <sub>L</sub> =50pF, R <sub>L</sub> =500Ω |                    | 4.0                |                    |      |
|                               |                 | V <sub>CC</sub> =5V±0.5 V   | C <sub>L</sub> =50pF, R <sub>L</sub> =500Ω |                    | 3.5                |                    |      |
| Power dissipation capacitance | C <sub>pd</sub> | V <sub>CC</sub> =1.8V       | f=10MHz                                    |                    | 16                 |                    | pF   |
|                               |                 | V <sub>CC</sub> =2.5V       |  |                    | 18                 |                    |      |
|                               |                 | V <sub>CC</sub> =3.3V       |  |                    | 18                 |                    |      |
|                               |                 | V <sub>CC</sub> =5V         |  |                    | 20                 |                    |      |

(1) All unused inputs of the device must be held at V<sub>CC</sub> or GND to ensure proper device operation.

(2) This parameter is ensured by design and/or characterization and is not tested in production.

(3) Typical values represent the most likely parametric norm as determined at the time of characterization. Actual typical values may vary over time and will also depend on the application and configuration.



## 10 Parameter Measurement Information

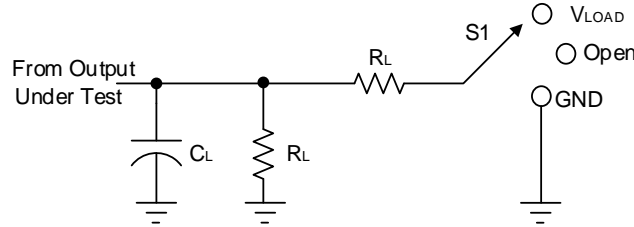

| TEST              | S1         |
|-------------------|------------|
| $t_{PLH}/t_{PHL}$ | Open       |
| $t_{PLZ}/t_{PZL}$ | $V_{LOAD}$ |
| $t_{PHZ}/t_{PZH}$ | GND        |

| $V_{CC}$         | INPUTS   |              | $V_M$      | $V_{LOAD}$        | CL   |      | RL          |              | $V_{\Delta}$ |
|------------------|----------|--------------|------------|-------------------|------|------|-------------|--------------|--------------|
|                  | $V_I$    | $t_r/t_f$    |            |                   |      |      |             |              |              |
| $1.8V \pm 0.15V$ | $V_{CC}$ | $\leq 2ns$   | $V_{CC}/2$ | $2 \times V_{CC}$ | 15pF | 30pF | 1M $\Omega$ | 1k $\Omega$  | 0.15V        |
| $2.5V \pm 0.2V$  | $V_{CC}$ | $\leq 2ns$   | $V_{CC}/2$ | $2 \times V_{CC}$ | 15pF | 30pF | 1M $\Omega$ | 500 $\Omega$ | 0.15V        |
| $3.3V \pm 0.3V$  | 3V       | $\leq 2.5ns$ | 1.5V       | 6V                | 15pF | 50pF | 1M $\Omega$ | 500 $\Omega$ | 0.3V         |
| $5V \pm 0.5V$    | $V_{CC}$ | $\leq 2.5ns$ | $V_{CC}/2$ | $2 \times V_{CC}$ | 15pF | 50pF | 1M $\Omega$ | 500 $\Omega$ | 0.3V         |

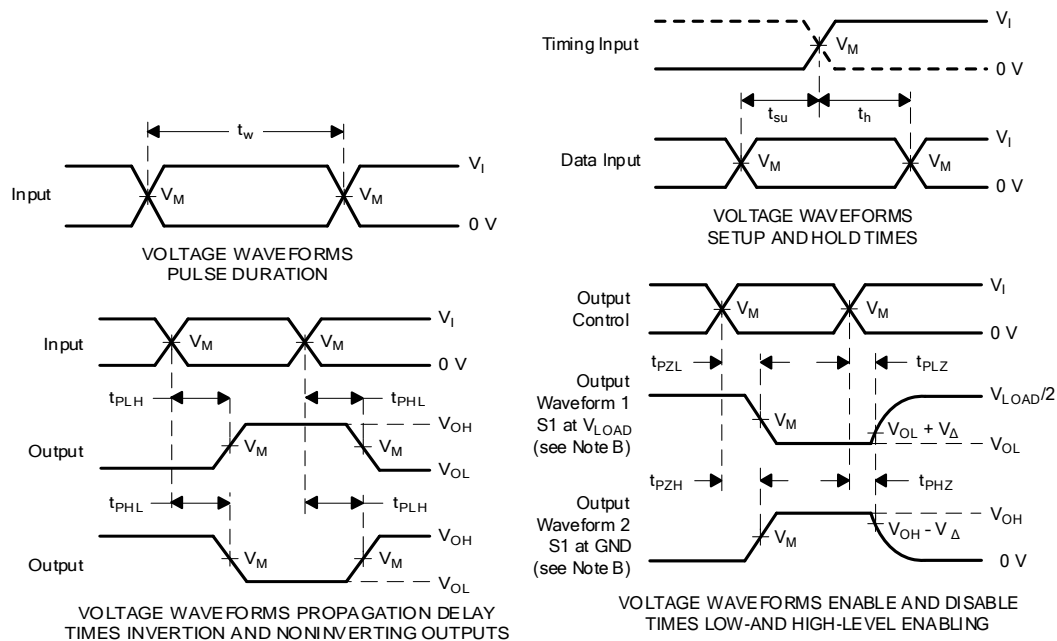

- NOTES: A. CL includes probe and jig capacitance.  
 B. Waveform 1 is for an output with internal conditions such that the output is low, except when disabled by the output control. Waveform 2 is for an output with internal conditions such that the output is high, except when disabled by the output control.  
 C. All input pulses are supplied by generators having the following characteristics:  $PRR \leq 10$  MHz,  $Z_O = 50 \Omega$ .  
 D. The outputs are measured one at a time, with one transition per measurement.  
 E.  $t_{PLZ}$  and  $t_{PHZ}$  are the same as  $t_{dis}$ .  
 F.  $t_{PZL}$  and  $t_{PZH}$  are the same as  $t_{en}$ .  
 G.  $t_{PLH}$  and  $t_{PHL}$  are the same as  $t_{pd}$ .  
 H. All parameters and waveforms are not applicable to all devices.

**Figure 1. Load Circuit and Voltage Waveforms**

## 11 Detailed Description

### 11.1 Overview

The RS1G34 device contains one buffer gate device and performs the Boolean function  $Y = A$ . This device is fully specified for partial-power-down applications using  $I_{off}$ . The  $I_{off}$  circuitry disables the outputs, preventing damaging current backflow through the device when it is powered down.

### 11.2 Functional Block Diagram



### 11.3 Feature Description

- Wide operating voltage range.
  - Operates from 1.65 V to 5.5 V.
- Allows down voltage translation.
- Inputs accept voltages to 5.5 V.
- $I_{off}$  feature allows voltages on the inputs and outputs when  $V_{CC}$  is 0 V.

## 12 Application and Implementation

Information in the following applications sections is not part of the Runic component specification, and Runic does not warrant its accuracy or completeness. Runic's customers are responsible for determining suitability of components for their purposes. Customers should validate and test their design implementation to confirm system functionality.

### 12.1 Application Information

The RS1G34 is a high drive CMOS device that can be used as a buffer with a high output drive, such as an LED application. It can produce 24 mA of drive current at 3.0 V making it ideal for driving multiple outputs and good for high speed applications up to 100MHz. The inputs are 5.5 V tolerant allowing it to translate down to  $V_{cc}$ .

### 12.2 Design Requirements

This device uses CMOS technology and has balanced output drive. Care should be taken to avoid bus contention because it can drive currents that would exceed maximum limits. The high drive will also create fast edges into light loads so routing and load conditions should be considered to prevent ringing.

## 13 Power Supply Recommendations

The power supply pin should have a good bypass capacitor to prevent power disturbance. For devices with a single supply, a 0.1uF capacitor is recommended and if there are multiple  $V_{cc}$  terminals then 0.01uF or 0.022uF capacitors are recommended for each power terminal. It is acceptable to parallel multiple bypass caps to reject different frequencies of noise. The 0.1 $\mu$ F and 1 $\mu$ F capacitors are commonly used in parallel. The bypass capacitor should be installed as close to the power terminal as possible.

## 14 Layout

### 14.1 Layout Guidelines

When using multiple bit logic devices inputs should not ever float. In many cases, functions or parts of functions of digital logic devices are unused; for example, when only two inputs of a triple-input AND gate are used or only 3 of the 4 buffer gates are used. Such input pins should not be left unconnected because the undefined voltages at the outside connections result in undefined operational states. Specified below are the rules that must be observed under all circumstances. All unused inputs of digital logic devices must be connected to a high or low bias to prevent them from floating. The logic level that should be applied to any particular unused input depends on the function of the device. Generally, they will be tied to GND or  $V_{CC}$  whichever make more sense or is more convenient.

### 14.2 Layout Example

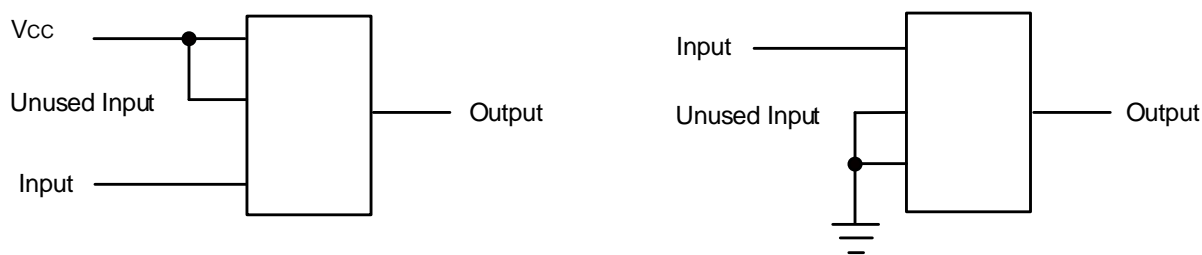
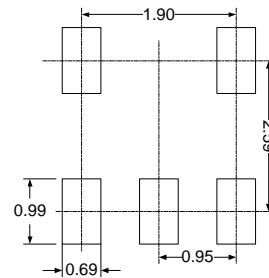
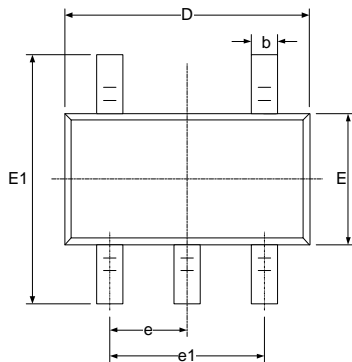

Figure 2. Layout Diagram

# 15 PACKAGE OUTLINE DIMENSIONS

## SOT23-5



RECOMMENDED LAND PATTERN (Unit: mm)

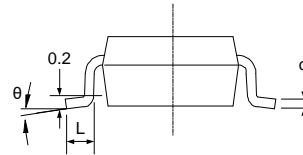
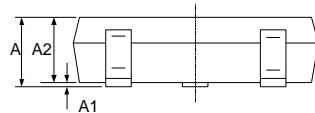

| Symbol   | Dimensions In Millimeters |       | Dimensions In Inches |       |
|----------|---------------------------|-------|----------------------|-------|
|          | Min                       | Max   | Min                  | Max   |
| A        | 1.050                     | 1.250 | 0.041                | 0.049 |
| A1       | 0.000                     | 0.100 | 0.000                | 0.004 |
| A2       | 1.050                     | 1.150 | 0.041                | 0.045 |
| b        | 0.300                     | 0.500 | 0.012                | 0.020 |
| c        | 0.100                     | 0.200 | 0.004                | 0.008 |
| D        | 2.820                     | 3.020 | 0.111                | 0.119 |
| E        | 1.500                     | 1.700 | 0.059                | 0.067 |
| E1       | 2.650                     | 2.950 | 0.104                | 0.116 |
| e        | 0.950(BSC)                |       | 0.037(BSC)           |       |
| e1       | 1.800                     | 2.000 | 0.071                | 0.079 |
| L        | 0.300                     | 0.600 | 0.012                | 0.024 |
| $\theta$ | 0°                        | 8°    | 0°                   | 8°    |

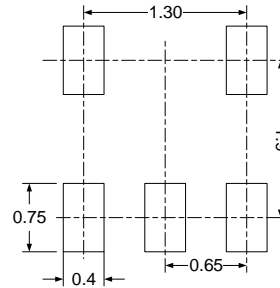
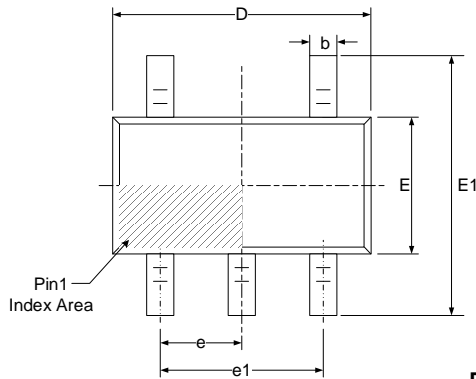
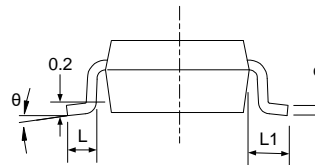
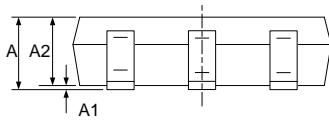
**SOT353(SC70-5)**

**RECOMMENDED LAND PATTERN (Unit: mm)**

| Symbol | Dimensions In Millimeters |       | Dimensions In Inches |       |
|--------|---------------------------|-------|----------------------|-------|
|        | Min                       | Max   | Min                  | Max   |
| A      | 0.900                     | 1.100 | 0.035                | 0.043 |
| A1     | 0.000                     | 0.100 | 0.000                | 0.004 |
| A2     | 0.900                     | 1.000 | 0.035                | 0.039 |
| b      | 0.150                     | 0.350 | 0.006                | 0.014 |
| c      | 0.080                     | 0.150 | 0.003                | 0.006 |
| D      | 2.000                     | 2.200 | 0.079                | 0.087 |
| E      | 1.150                     | 1.350 | 0.045                | 0.053 |
| E1     | 2.150                     | 2.450 | 0.085                | 0.096 |
| e      | 0.650(BSC)                |       | 0.026(BSC)           |       |
| e1     | 1.300(BSC)                |       | 0.051(BSC)           |       |
| L      | 0.260                     | 0.460 | 0.010                | 0.018 |
| L1     | 0.525                     |       | 0.021                |       |
| θ      | 0°                        | 8°    | 0°                   | 8°    |

**NOTE:**

- A. All linear dimension is in millimeters.
- B. This drawing is subject to change without notice.
- C. Body dimensions do not include mold flash or protrusion. Mold flash and protrusion shall not exceed 0.15 per side.
- D. BSC: Basic Dimension. Theoretically exact value shown without tolerances.

# 16 TAPE AND REEL INFORMATION

## REEL DIMENSIONS

## TAPE DIMENSION

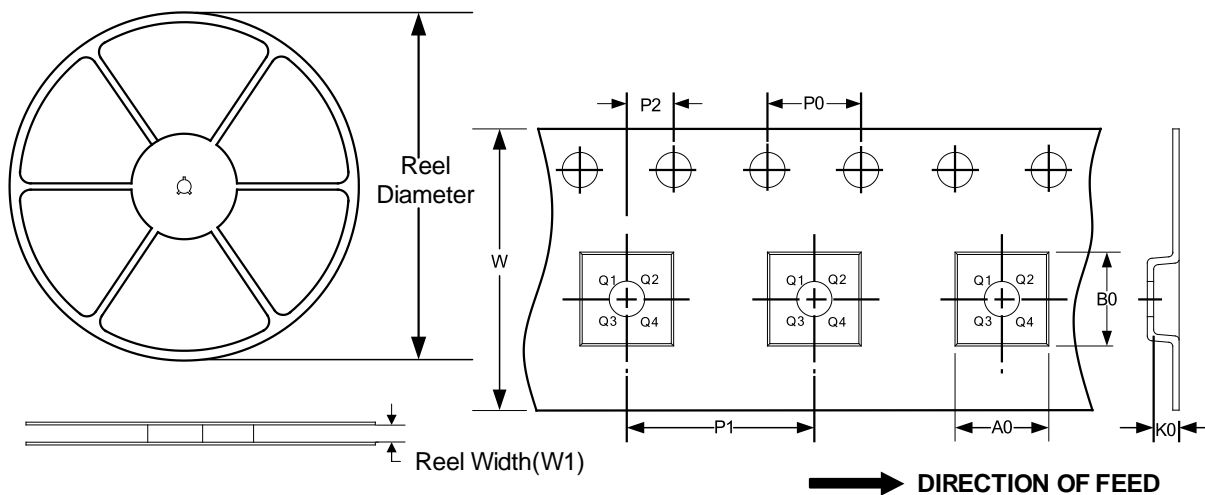

NOTE: The picture is only for reference. Please make the object as the standard.

### KEY PARAMETER LIST OF TAPE AND REEL

| Package Type   | Reel Diameter | Reel Width(mm) | A0 (mm) | B0 (mm) | K0 (mm) | P0 (mm) | P1 (mm) | P2 (mm) | W (mm) | Pin1 Quadrant |
|----------------|---------------|----------------|---------|---------|---------|---------|---------|---------|--------|---------------|
| SOT353(SC70-5) | 7"            | 9.5            | 2.25    | 2.55    | 1.20    | 4.0     | 4.0     | 2.0     | 8.0    | Q3            |
| SOT23-5        | 7"            | 9.5            | 3.20    | 3.20    | 1.40    | 4.0     | 4.0     | 2.0     | 8.0    | Q3            |

NOTE:

1. All dimensions are nominal.
2. Plastic or metal protrusions of 0.15mm maximum per side are not included.

## **IMPORTANT NOTICE AND DISCLAIMER**

Jiangsu Runic Technology Co., Ltd. will accurately and reliably provide technical and reliability data (including data sheets), design resources (including reference designs), application or other design advice, WEB tools, safety information and other resources, without warranty of any defect, and will not make any express or implied warranty, including but not limited to the warranty of merchantability Implied warranty that it is suitable for a specific purpose or does not infringe the intellectual property rights of any third party.

These resources are intended for skilled developers designing with Runic products You will be solely responsible for: (1) Selecting the appropriate products for your application; (2) Designing, validating and testing your application; (3) Ensuring your application meets applicable standards and any other safety, security or other requirements; (4) Runic and the Runic logo are registered trademarks of Runic Incorporated. All trademarks are the property of their respective owners; (5) For change details, review the revision history included in any revised document. The resources are subject to change without notice. Our company will not be liable for the use of this product and the infringement of patents or third-party intellectual property rights due to its use.



## X-ON Electronics

Largest Supplier of Electrical and Electronic Components

*Click to view similar products for [Buffers & Line Drivers](#) category:*

*Click to view products by [RUNIC](#) manufacturer:*

Other Similar products are found below :

[LXV200-024SW](#) [74AUP2G34FW3-7](#) [HEF4043BP](#) [NL17SG125DFT2G](#) [NLU1GT126CMUTCG](#) [CD4041UBE](#) [54FCT240CTDB](#)  
[74HCT540N](#) [DS14C88N](#) [070519XB](#) [NL17SZ07P5T5G](#) [74LVC2G17FW4-7](#) [CD4502BE](#) [5962-8982101PA](#) [61446R00](#) [NL17SH17P5T5G](#)  
[NLV37WZ17USG](#) [74HCT126T14-13](#) [74VHC9126FT\(BJ\)](#) [RHRXH162244K1](#) [74AUP1G34FW5-7](#) [74AUP1G07FW5-7](#) [74LVC1G126FW4-7](#)  
[74LVC2G126RA3-7](#) [74LVCE1G125FZ4-7](#) [54FCT240TLB](#) [NLX3G16DMUTCG](#) [NLX2G06AMUTCG](#) [LE87100NQCT](#) [LE87285NQC](#)  
[LE87290YQC](#) [LE87290YQCT](#) [74AUP1G125FW5-7](#) [NLU2G16CMUTCG](#) [MC74LCX244MN2TWG](#) [NL17SG17P5T5G](#)  
[NLV74HC125ADR2G](#) [NLVHCT245ADTR2G](#) [NLVVHC1G126DFT2G](#) [EL5623IRZ](#) [ISL15102AIRZ-T13](#) [ISL1539IRZ-T13](#)  
[MC100EP17MNG](#) [MC74HCT365ADR2G](#) [MC74LCX244ADTR2G](#) [NL27WZ126US](#) [NL37WZ16US](#) [NLU1G07MUTCG](#) [NLU2G07MUTCG](#)  
[NLX3G17BMX1TCG](#)