

RS1G86 Single 2-Input Exclusive-OR Gate

FEATURES

- **Operating Voltage Range:** 1.65V to 5.5V
- **Low Power Consumption:** 1µA (Max)
- **Operating Temperature Range:** -40°C to +125°C
- **Inputs Accept Voltage to 5.5V**
- **High Output Drive:** ±24mA at V_{CC}=3.0V
- **Micro SIZE PACKAGES:** SOT23-5, SC70-5

APPLICATIONS

- AV Receiver
- Blu-ray Player and Home Theater
- Digital Picture Frame (DPF)
- High-Speed Data Acquisition and Generation
- Personal Navigation Device (GPS)
- Portable Media Player

LOGIC SYMBOL



IEE/IEC LOGIC SYMBOL

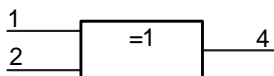

DESCRIPTION

The RS1G86 single 2-input exclusive-OR gate is designed for 1.65V to 5.5V V_{CC} operation.

The RS1G86 device performs the Boolean function $Y = \bar{A}B + A\bar{B}$ in positive logic. The device is fully specified for partial-power-down applications using I_{off}. The I_{off} circuitry disables the outputs, preventing damaging current backflow through the device when it is powered down.

The RS1G86 is available in Green SOT23-5 and SC70-5 packages. It operates over an ambient temperature range of -40°C to +125°C.

Device Information (1)

PART NUMBER	PACKAGE	BODY SIZE (NOM)
RS1G86	SOT23-5(5)	2.92mm×1.60mm
	SC70-5(5)	2.10mm×1.25mm

(1) For all available packages, see the orderable addendum at the end of the data sheet.

FUNCTION TABLE

INPUTS		OUTPUT
A	B	Y
H	H	L
L	H	H
H	L	H
L	L	L

H=High Voltage Level

L=Low Voltage Level

Revision History

Note: Page numbers for previous revisions may differ from page numbers in the current version.

Version	Change Date	Change Item
A.1	2021/01/21	Initial version completed
A.2	2022/04/27	1. Added the TAPE AND REEL INFORMATION 2. Update PACKAGE MARKING on Page 5@RevA.1

PIN CONFIGURATIONS

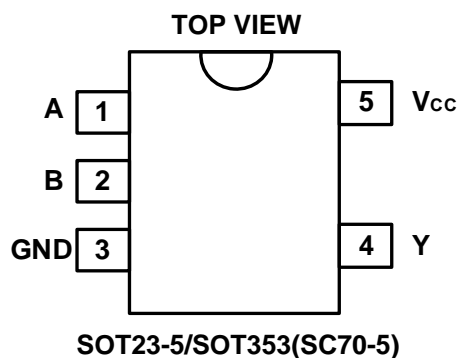

PIN DESCRIPTION

PIN	NAME	I/O TYPE	FUNCTION
SOT23-5/SOT353(SC70-5)			
1	A	I	Input A
2	B	I	Input B
3	GND	P	Ground
4	Y	O	Output Y
5	V _{CC}	P	Power pin

Specifications

Absolute Maximum Ratings ⁽¹⁾

over operating free-air temperature range (unless otherwise noted) ⁽¹⁾ ⁽²⁾

		MIN	MAX	UNIT
V _{CC}	Supply voltage range	-0.5	6.5	V
V _I	Input voltage range ⁽²⁾	-0.5	6.5	V
V _O	Voltage range applied to any output in the high-impedance or power-off state ⁽²⁾	-0.5	6.5	V
V _O	Voltage range applied to any output in the high or low state ⁽²⁾ ⁽³⁾	-0.5	V _{CC} +0.5	V
I _{IK}	Input clamp current	V _I <0	-50	mA
I _{OK}	Output clamp current	V _O <0	-50	mA
I _O	Continuous output current		±50	mA
	Continuous current through V _{CC} or GND		±100	mA
T _J	Junction temperature	-65	150	°C
T _{stg}	Storage temperature	-65	150	°C

(1) Stresses beyond those listed under *Absolute Maximum Ratings* may cause permanent damage to the device. These are stress ratings only, and functional operation of the device at these or any other conditions beyond those indicated under *Recommended Operating Conditions* is not implied. Exposure to absolute-maximum-rated conditions for extended periods may affect device reliability.

(2) The input and output negative-voltage ratings may be exceeded if the input and output current ratings are observed.

(3) The value of V_{CC} is provided in the *Recommended Operating Conditions table*.

ESD Ratings

		VALUE	UNIT	
V _(ESD)	Electrostatic discharge	Human-body model (HBM)	±8000	V
		Machine model (MM)	±500	V

Thermal Information:

THERMAL METRIC		RS1G86		UNIT
		5PINS		
		SOT23-5	SOT353/(SC70-5)	
R _{θJA}	Junction-to-ambient thermal resistance	273.8	214.7	°C/W
R _{θJC(top)}	Junction-to-case(top) thermal resistance	126.8	127.1	°C/W
R _{θJB}	Junction-to-board thermal resistance	85.9	60.0	°C/W
Ψ _{JT}	Junction-to-top characterization parameter	10.9	33.4	°C/W
Ψ _{JB}	Junction-to-board characterization parameter	84.9	59.8	°C/W
R _{θJC(bot)}	Junction-to-case(bottom) thermal resistance	N/A	N/A	°C/W

PACKAGE/ORDERING INFORMATION

PRODUCT	ORDERING NUMBER	TEMPERATURE RANGE	PACKAGE LEAD	PACKAGE MARKING ⁽¹⁾	PACKAGE OPTION
RS1G86	RS1G86XF5	-40°C ~+125°C	SOT23-5	1G86	Tape and Reel,3000
	RS1G86XC5	-40°C ~+125°C	SC70-5(SOT353)	1G86	Tape and Reel,3000

NOTE:

- (1) There may be additional marking, which relates to the lot trace code information (data code and vendor code), the logo or the environmental category on the device.

ELECTRICAL CHARACTERISTICS

over recommended operating free-air temperature range (TYP values are at $T_A = +25^\circ\text{C}$, unless otherwise noted.) ⁽¹⁾

Recommended Operating Conditions

PARAMETER	SYMBOL	TEST CONDITIONS	MIN	MAX	UNIT
Supply voltage	V_{CC}	Operating	1.65	5.5	V
		Data retention only	1.5		
High-level input voltage	V_{IH}	$V_{CC}=1.65\text{V to }1.95\text{V}$	$0.65 \times V_{CC}$		V
		$V_{CC}=2.3\text{V to }2.7\text{V}$	1.7		
		$V_{CC}=3\text{V to }3.6\text{V}$	2.2		
		$V_{CC}=4.5\text{V to }5.5\text{V}$	$0.7 \times V_{CC}$		
Low-level input voltage	V_{IL}	$V_{CC}=1.65\text{V to }1.95\text{V}$		$0.20 \times V_{CC}$	V
		$V_{CC}=2.3\text{V to }2.7\text{V}$		0.3	
		$V_{CC}=3\text{V to }3.6\text{V}$		0.4	
		$V_{CC}=4.5\text{V to }5.5\text{V}$		$0.15 \times V_{CC}$	
Input voltage	V_I		0	5.5	V
Output voltage	V_O		0	V_{CC}	V
Input transition rise or fall	t_r, t_f	$V_{CC}=1.8\text{V} \pm 0.15\text{V}, 2.5\text{V} \pm 0.2\text{V}$		20	ns/V
		$V_{CC}=3.3\text{V} \pm 0.3\text{V}$		10	
		$V_{CC}=5\text{V} \pm 0.5\text{V}$		5	
Operating temperature	T_A		-40	+125	$^\circ\text{C}$

DC Characteristics

PARAMETER	TEST CONDITIONS	V_{CC}	TEMP	MIN	TYP	MAX	UNIT
V_{OH}	$I_{OH} = -100\mu\text{A}$	1.65V to 5.5V	Full	$V_{CC}-0.1$			V
	$I_{OH} = -4\text{mA}$	1.65V		1.2			
	$I_{OH} = -8\text{mA}$	2.3V		1.9			
	$I_{OH} = -16\text{mA}$	3V		2.4			
	$I_{OH} = -24\text{mA}$			2.3			
	$I_{OH} = -32\text{mA}$	4.5V		3.8			
V_{OL}	$I_{OL} = 100\mu\text{A}$	1.65V to 5.5V	Full			0.1	V
	$I_{OL} = 4\text{mA}$	1.65V				0.45	
	$I_{OL} = 8\text{mA}$	2.3V				0.3	
	$I_{OL} = 16\text{mA}$	3V				0.4	
	$I_{OL} = 24\text{mA}$					0.55	
	$I_{OL} = 32\text{mA}$	4.5V				0.55	
I_i	A or B inputs	$V_I=5.5\text{V or GND}$	0V to 5.5V	+25 $^\circ\text{C}$	± 0.1	± 1	μA
				Full		± 5	
I_{off}		$V_I \text{ or } V_O=5.5\text{V}$	0V	+25 $^\circ\text{C}$	± 0.1	± 1	μA
				Full		± 10	
I_{CC}		$V_I=5.5\text{V or GND}, I_o=0$	1.65V to 5.5V	+25 $^\circ\text{C}$	0.1	1	μA
				Full		10	
ΔI_{CC}		One input at $V_{CC}-0.6\text{V}$, Other inputs at V_{CC} or GND	3V to 5.5V	Full		500	μA

AC Characteristics

($T_A = -40^{\circ}\text{C}$ to $+25^{\circ}\text{C}$, typical values are at $T_A = +25^{\circ}\text{C}$, unless otherwise noted.) ⁽¹⁾

PARAMETER	SYMBOL	TEST CONDITIONS		MIN	TYP	MAX	UNIT
Propagation Delay	t_{pd}	$V_{CC}=1.8V\pm 0.15V$	$C_L=30pF, R_L=1k\Omega$		14.2		ns
		$V_{CC}=2.5V\pm 0.2V$	$C_L=30pF, R_L=500\Omega$		11.1		
		$V_{CC}=3.3V\pm 0.3V$	$C_L=50pF, R_L=500\Omega$		6.7		
		$V_{CC}=5V\pm 0.5V$	$C_L=50pF, R_L=500\Omega$		5.3		
Input Capacitance	C_i	$V_{CC}=3.3V$	$V_I=V_{CC}$ or GND		4		pF
Power dissipation capacitance	C_{pd}	$V_{CC}=1.8V$	$f=10MHz$		20		pF
		$V_{CC}=2.5V$			21		
		$V_{CC}=3.3V$			22		
		$V_{CC}=5V$			25		

(1) All unused inputs of the device must be held at V_{CC} or GND to ensure proper device operation.

Parameter Measurement Information

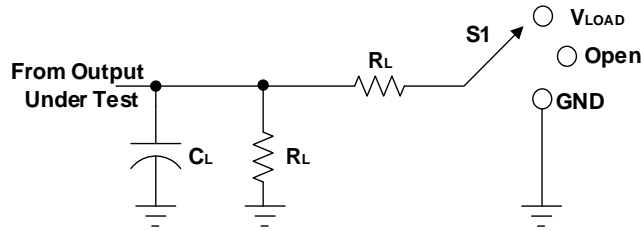

TEST	S1
t_{PLH}/t_{PHL}	Open
t_{PLZ}/t_{PZL}	V_{LOAD}
t_{PHZ}/t_{PZH}	GND

V_{CC}	INPUTS		V_M	V_{LOAD}	C_L	R_L	V_{Δ}
	V_I	t_r/t_f					
$1.8V \pm 0.15V$	V_{CC}	$\leq 2ns$	$V_{CC}/2$	$2 \times V_{CC}$	15pF	1M Ω	0.15V
$2.5V \pm 0.2V$	V_{CC}	$\leq 2ns$	$V_{CC}/2$	$2 \times V_{CC}$	15pF	1M Ω	0.15V
$3.3V \pm 0.3V$	3V	$\leq 2.5ns$	1.5V	6V	15pF	1M Ω	0.3V
$5V \pm 0.5V$	V_{CC}	$\leq 2.5ns$	$V_{CC}/2$	$2 \times V_{CC}$	15pF	1M Ω	0.3V

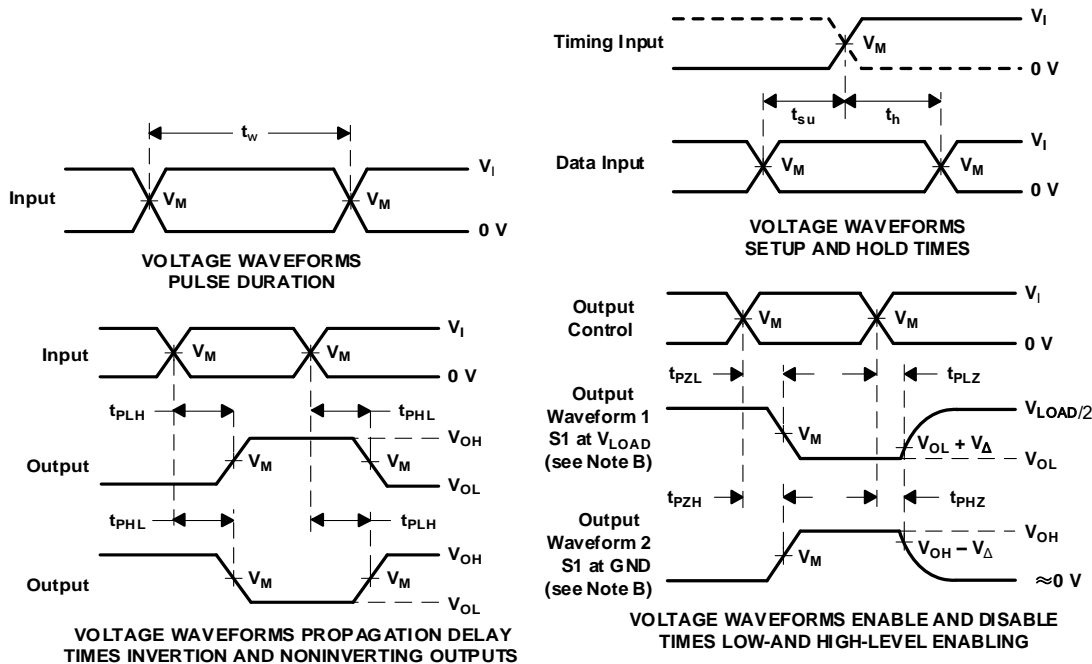

- NOTES:
- A. C_L includes probe and jig capacitance.
 - B. Waveform 1 is for an output with internal conditions such that the output is low, except when disabled by the output control. Waveform 2 is for an output with internal conditions such that the output is high, except when disabled by the output control.
 - C. All input pulses are supplied by generators having the following characteristics: $PRR \leq 10 \text{ MHz}$, $Z_0 = 50 \Omega$.
 - D. The outputs are measured one at a time, with one transition per measurement.
 - E. t_{PLZ} and t_{PHZ} are the same as t_{dis} .
 - F. t_{PZL} and t_{PZH} are the same as t_{en} .
 - G. t_{PLH} and t_{PHL} are the same as t_{pd} .
 - H. All parameters and waveforms are not applicable to all devices.

Figure 1. Load Circuit and Voltage Waveforms

PACKAGE OUTLINE DIMENSIONS

SOT23-5

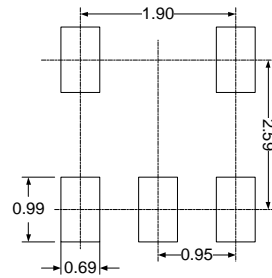
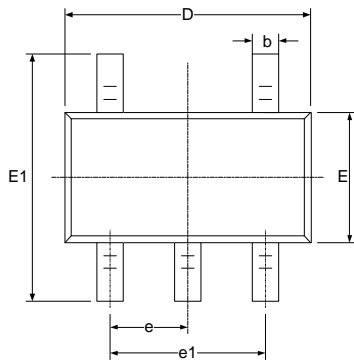
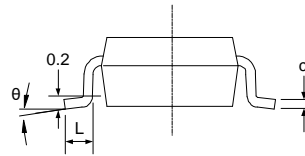
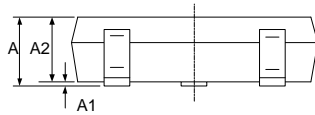
RECOMMENDED LAND PATTERN (Unit: mm)

Symbol	Dimensions In Millimeters		Dimensions In Inches	
	Min	Max	Min	Max
A	1.050	1.250	0.041	0.049
A1	0.000	0.100	0.000	0.004
A2	1.050	1.150	0.041	0.045
b	0.300	0.500	0.012	0.020
c	0.100	0.200	0.004	0.008
D	2.820	3.020	0.111	0.119
E	1.500	1.700	0.059	0.067
E1	2.650	2.950	0.104	0.116
e	0.950(BSC)		0.037(BSC)	
e1	1.800	2.000	0.071	0.079
L	0.300	0.600	0.012	0.024
θ	0°	8°	0°	8°

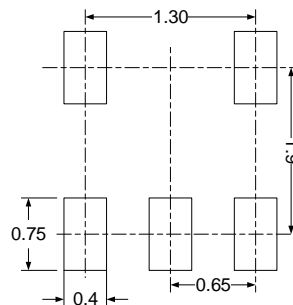
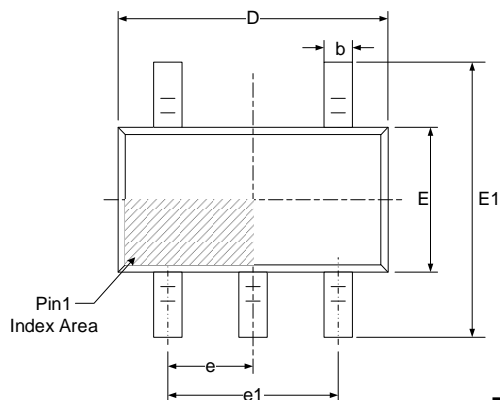
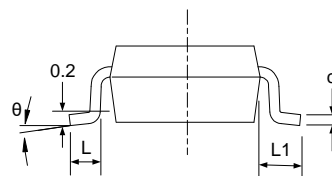
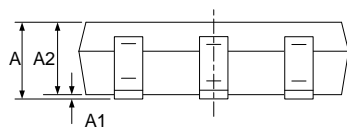
SOT353(SC70-5)

RECOMMENDED LAND PATTERN (Unit: mm)

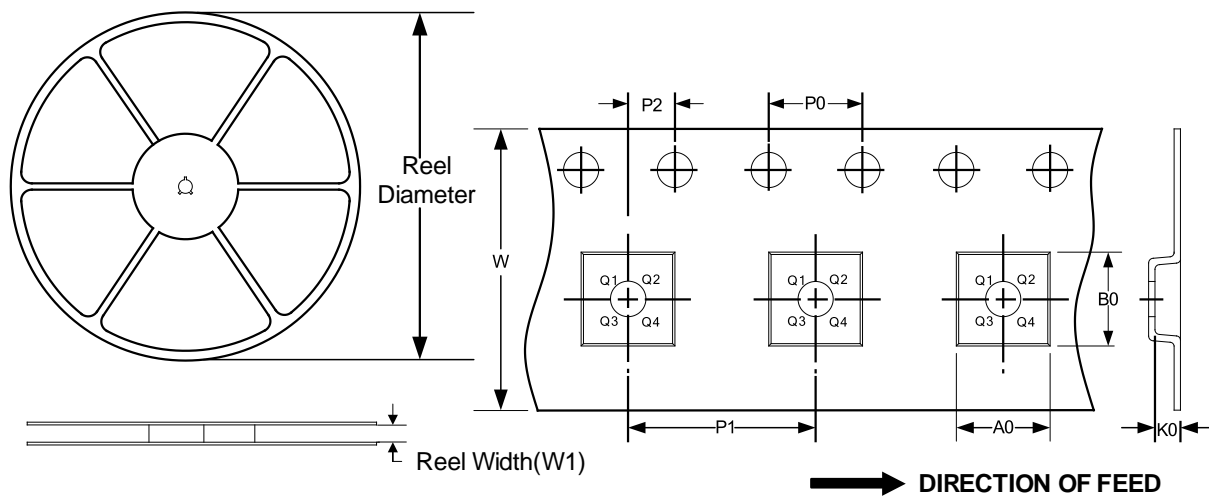
Symbol	Dimensions In Millimeters		Dimensions In Inches	
	Min	Max	Min	Max
A	0.900	1.100	0.035	0.043
A1	0.000	0.100	0.000	0.004
A2	0.900	1.000	0.035	0.039
b	0.150	0.350	0.006	0.014
c	0.080	0.150	0.003	0.006
D	2.000	2.200	0.079	0.087
E	1.150	1.350	0.045	0.053
E1	2.150	2.450	0.085	0.096
e	0.650(BSC)		0.026(BSC)	
e1	1.300(BSC)		0.051(BSC)	
L	0.260	0.460	0.010	0.018
L1	0.525		0.021	
θ	0°	8°	0°	8°

TAPE AND REEL INFORMATION
REEL DIMENSIONS
TAPE DIMENSION

NOTE: The picture is only for reference. Please make the object as the standard.

KEY PARAMETER LIST OF TAPE AND REEL

Package Type	Reel Diameter	Reel Width(mm)	A0 (mm)	B0 (mm)	K0 (mm)	P0 (mm)	P1 (mm)	P2 (mm)	W (mm)	Pin1 Quadrant
SOT23-5	7"	9.5	3.20	3.20	1.40	4.0	4.0	2.0	8.0	Q3
SOT353(SC70-5)	7"	9.5	2.25	2.55	1.20	4.0	4.0	2.0	8.0	Q3

X-ON Electronics

Largest Supplier of Electrical and Electronic Components

Click to view similar products for [Logic Gates](#) category:

Click to view products by [RUNIC](#) manufacturer:

Other Similar products are found below :

[74HC85N](#) [NL17SG32DFT2G](#) [CD4068BE](#) [NL17SG86DFT2G](#) [NLV14001UBDR2G](#) [NLX1G11AMUTCG](#) [NLX1G97MUTCG](#) [74LS38](#)
[74LVC1G08Z-7](#) [74LVC32ADTR2G](#) [CD4025BE](#) [MC74HCT20ADTR2G](#) [NLV17SZ00DFT2G](#) [NLV17SZ126DFT2G](#) [NLV27WZ17DFT2G](#)
[NLV74HC02ADR2G](#) [74HC32S14-13](#) [74LS133](#) [74LVC1G32Z-7](#) [74LVC1G86Z-7](#) [NLV74HC14ADR2G](#) [NLV74HC20ADR2G](#)
[NLVVHC1G09DFT1G](#) [NLX2G86MUTCG](#) [74LVC2G32RA3-7](#) [74LVC2G00HD4-7](#) [NL17SG02P5T5G](#) [74LVC2G86HK3-7](#)
[NLV7SZ97DFT2G](#) [NLVVHC1G14DFT2G](#) [NLX1G99DMUTWG](#) [NLVVHC1G00DFT2G](#) [NLV7SZ57DFT2G](#) [NLV74VHC04DTR2G](#)
[NLV27WZ00USG](#) [NLU1G86CMUTCG](#) [NLU1G08CMUTCG](#) [NL17SZ32P5T5G](#) [NL17SZ00P5T5G](#) [NL17SH02P5T5G](#) [74AUP2G00RA3-7](#)
[NLVVHC1GT00DFT2G](#) [NLV74HC02ADTR2G](#) [NLX1G332CMUTCG](#) [NLVHCT132ADTR2G](#) [NL17SG86P5T5G](#) [NL17SZ05P5T5G](#)
[NLV74VHC00DTR2G](#) [NLVVHC1G02DFT1G](#) [NLV74HC86ADR2G](#)