

Low Quiescent Current Power Distribution Switch

1 FEATURES

- 70mΩ (TYP) High-side P-Channel MOSFET
- Low Quiescent Current
- Input Voltage from 2.5V to 5.5V
- Three Current Limit Levels
1.1A, 2.1A, 2.6A
- Maximum Shutdown Current $\leq 1\mu\text{A}$
- Soft-Start Function
- Under-Voltage Lockout Protection for VIN
- No Reversed Leakage Current
- Thermal Shutdown Protection
- Operation temperature from -40°C to 85°C
- Lead-Free Packages: SOT23-5

2 APPLICATIONS

- Smart Phone & LCD TV
- Set-Top Boxes
- VOIP
- USB Bus/Self Powered Hubs/Peripherals
- Portable Consumer or Medical Products

3 DESCRIPTION

The RS2588 is an integrated 70mΩ(TYP) power switch for self-powered and bus-powered universal series bus (USB) applications.

The RS2588 is internally current limited and has thermal shutdown function to protect device and load from over-current damage. Thermal shutdown shuts off the output MOSFET and asserts the flag pin output if the die temperature exceeds 150°C until the die temperature drops to 130°C .

The soft-start circuit can minimize inrush current in applications where highly capacitive loads are employed.

The flag pin asserts low when during over-current and thermal conditions after a 13ms blanking time to prevent false reporting.

The RS2588 is available in SOT23-5 package. It is rated over the -40°C to $+85^{\circ}\text{C}$ temperature range.

Device Information ⁽¹⁾

PART NUMBER	PACKAGE	BODY SIZE (NOM)
RS2588	SOT23-5(5)	2.92mm×1.60mm

(1) For all available packages, see the orderable addendum at the end of the data sheet.

4 Typical Application

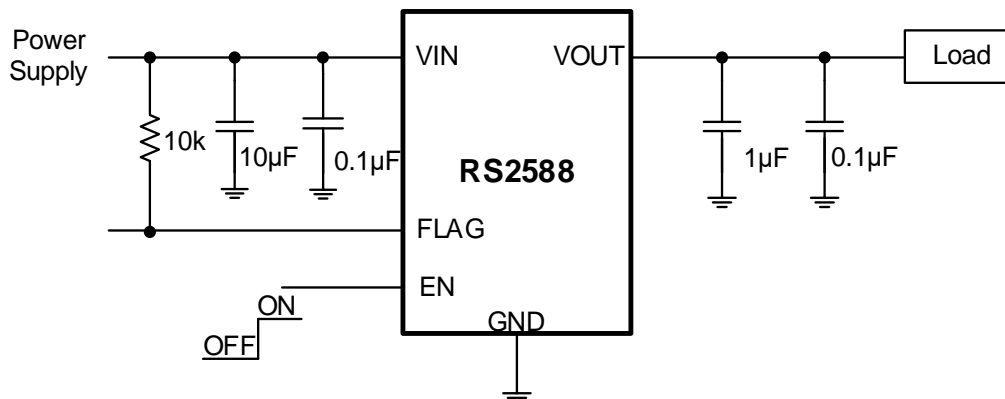

5 Functional Block Diagram

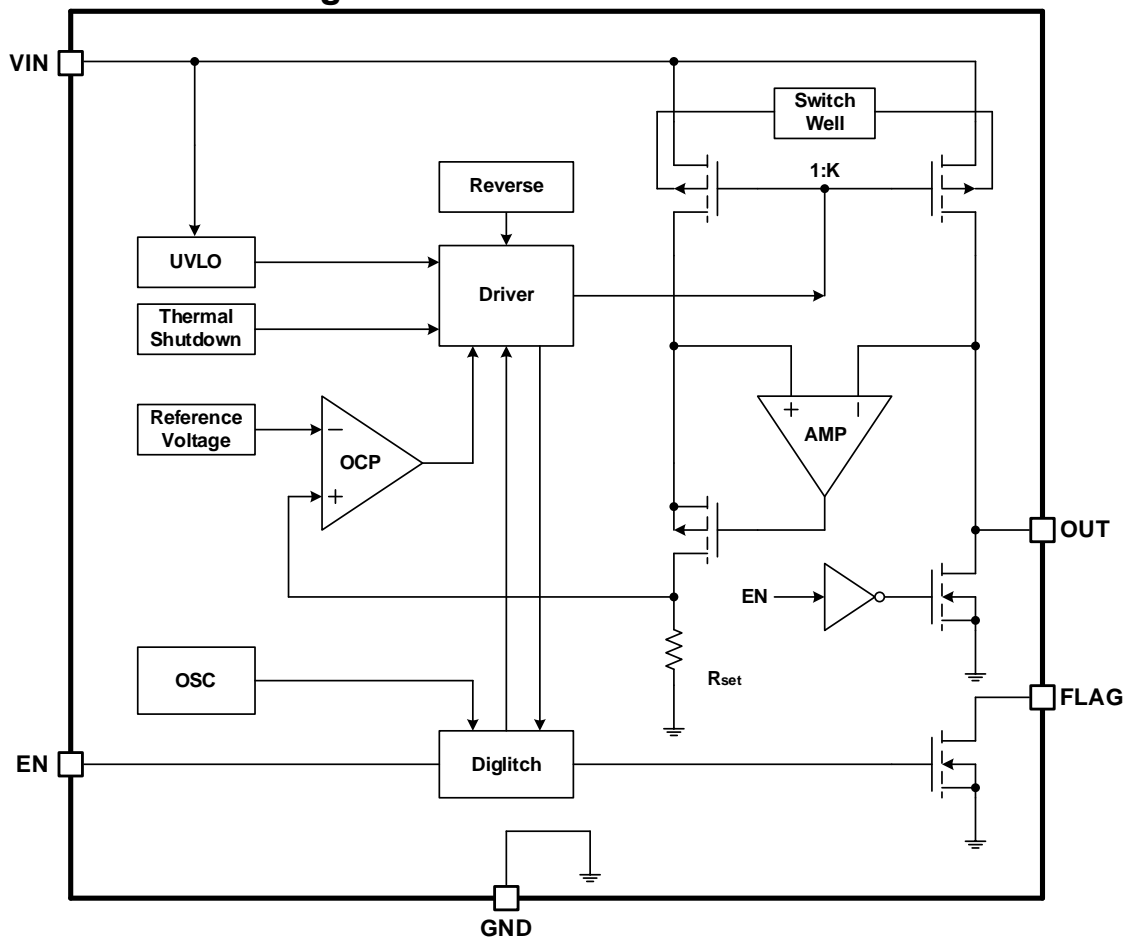

Table of Contents

1 FEATURES	1
2 APPLICATIONS	1
3 DESCRIPTION	1
4 Typical Application	1
5 Functional Block Diagram	2
6 Revision History	4
7 PACKAGE/ORDERING INFORMATION	5
8 PIN CONFIGURATIONS	6
9 SPECIFICATIONS	7
9.1 Absolute Maximum Ratings	7
9.2 ESD Ratings	7
9.3 Recommended Operating Conditions	7
9.4 Thermal Information	7
9.5 Electrical Characteristics	8
9.6 PARAMETER MEASUREMENT INFORMATION	9
9.7 Typical Performance Characteristics	10
10 FUNCTIONAL DESCRIPTION	15
10.1 Input and output	15
10.2 Thermal Shutdown	15
10.3 Soft-Start	15
10.4 Current limiting and Short protection	15
10.5 Reverse-voltage protection	15
10.6 FLAG output	15
10.7 Power dissipation	15
11 APPLICATION INFORMATION	16
11.1 Supply filter capacitor	16
11.2 Output filter capacitor	16
11.3 PCB layout guide	16
12 PACKAGE OUTLINE DIMENSIONS	17
13 TAPE AND REEL INFORMATION	18

6 Revision History

Note: Page numbers for previous revisions may differ from page numbers in the current version.

VERSION	Change Date	Change Item
A.0	2021/12/20	Initial version completed
A.1	2022/06/22	Official version completed

7 PACKAGE/ORDERING INFORMATION

PRODUCT	ORDERING NUMBER	TEMPERATURE RANGE	PACKAGE LEAD	PACKAGE MARKING ⁽¹⁾	PACKAGE OPTION
RS2588	RS2588AYF5	-40°C ~+85°C	SOT23-5	2588A	Tape and Reel,3000
	RS2588BYF5	-40°C ~+85°C	SOT23-5	2588B	Tape and Reel,3000
	RS2588CYF5	-40°C ~+85°C	SOT23-5	2588C	Tape and Reel,3000

NOTE:

- (1) There may be additional marking, which relates to the lot trace code information(include data code and vendor code), the logo or the environmental category on the device.

8 PIN CONFIGURATIONS

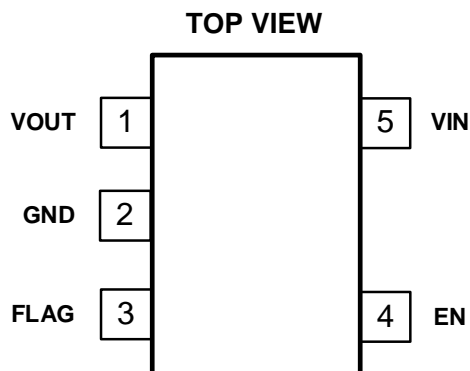

NAME	PIN	DESCRIPTION
VOUT	1	Switch Output. The P-Channel Drain of Switch, Which Typically Connects to Load.
GND	2	Ground
FLAG	3	Flag pin. Active low, open-drain output. Indicates over-current or thermal shutdown conditions. Over-current condition must last longer than t_D in order to assert Flag.
EN	4	Enable Input. Logic Level Enable Input, Active high available.
VIN	5	Power Supply Input. The P-Channel Source of Switch, which also supplies IC's internal circuitry. Connect to Positive Supply.

9 SPECIFICATIONS

9.1 Absolute Maximum Ratings

over operating free-air temperature range (unless otherwise noted) ⁽¹⁾⁽²⁾

Characteristics	Symbol	MIN	MAX	UNIT
Supply Input Voltage	V _{IN}	-0.3	6.0	V
Output Voltage	V _{OUT}	-0.3	6.0	V
EN Input Voltage	V _{EN}	-0.3	6.0	V
FLAG Output Voltage	V _{FLAG}	-0.3	6.0	V
Operating Junction Temperature	T _J	-40	+150	°C
Storage Temperature	T _{stg}	-65	150	°C
Lead Temperature (Soldering, 10secs)	T _L		260	°C

(1) Stresses beyond those listed under *Absolute Maximum Ratings* may cause permanent damage to the device. These are stress ratings only, and functional operation of the device at these or any other conditions beyond those indicated under *Recommended Operating Conditions* is not implied. Exposure to absolute-maximum-rated conditions for extended periods may affect device reliability.

(2) All voltages are with respect to the GND pin.

9.2 ESD Ratings

		VALUE	UNIT	
V _(ESD)	Electrostatic discharge	Human-body model (HBM)	±3000	V
		Charge device model (CDM)	±1500	V

9.3 Recommended Operating Conditions

over operating free-air temperature range (unless otherwise noted)

Characteristics	Symbol	MIN	MAX	UNIT
Input Voltage	V _{IN}	2.5	5.5	V
EN Voltage range	V _{EN}	0	5.5	V
All other pins		0	5.5	V
Operating Temperature Range	T _A	-40	+85	°C
Operating Junction Temperature Range	T _J	-40	+125	°C

9.4 Thermal Information

THERMAL METRIC		RS2588	UNIT
		SOT23-5	
		5 PINS	
R _{θJA}	Junction-to-ambient thermal resistance	185.6	°C/W
R _{θJC(top)}	Junction-to-case (top) thermal resistance	104.3	°C/W
R _{θJB}	Junction-to-board thermal resistance	54.5	°C/W
ψ _{JT}	Junction-to-top characterization parameter	31.0	°C/W
ψ _{JB}	Junction-to-board characterization parameter	54.5	°C/W
R _{JC(bot)}	Junction-to-case (bottom) thermal resistance	N/A	°C/W

9.5 Electrical Characteristics

(At $V_{IN}=5V$, $T_A = +25^{\circ}C$, unless otherwise noted.)

PARAMETER	SYMBOL	CONDITIONS	MIN	TYP	MAX	UNITS
Input Voltage	V_{IN}		2.5		5.5	V
Quiescent supply current	I_Q	Switch on, $V_{OUT} = \text{open}$	10	30	50	μA
Shutdown supply current	I_{SD}	Switch off, $V_{OUT} = \text{open}$		0.1	1.0	μA
Leakage current of V_{IN}	$I_{LKG(VIN)}$	Switch off, $V_{OUT} = 0V$		0.1	1.0	μA
Enable input threshold	V_{IL}	$V_{IN} = 2.5V \text{ to } 5.5V$			0.4	V
	V_{IH}	$V_{IN} = 2.5V \text{ to } 5.5V$	1.6			V
EN input current	I_{EN}	$V_{EN} = 0V \text{ to } 5.5V$		10	15	μA
EN Pin Pull-Down Resistance	R_{PULL_DOWN}	$V_{EN} = 2.5V \text{ to } 5.5V$	450	520	600	k Ω
Switch resistance	$R_{DS(ON)}$	$I_{OUT} = 500mA$		70	80	m Ω
Output turn-on delay time	t_{ON}	$R_L = 10\Omega$, $C_L = 1\mu F$, Figure 4,5		2		ms
Output turn-off delay time	t_{OFF}	$R_L = 10\Omega$, $C_L = 1\mu F$, Figure 6,7		20		μs
Current limit threshold	RS2588A	Ramped load	0.99	1.1	1.21	A
	RS2588B	Ramped load	1.89	2.1	2.31	A
	RS2588C	Ramped load	2.34	2.6	2.86	A
Under-Voltage Lockout Threshold	V_{UVLO}	V_{IN} rising		1.9	2.3	V
Under-Voltage Lockout Threshold Hysteresis	V_{UVLO_HY}			0.15		V
Over-current FLAG response delay time	t_D	Apply $V_{OUT} = 0$ until FLAG is low		13		ms
Leakage current of FLAG	$I_{LKG(FLAG)}$	FLAG is HIGH		0.1	1.0	μA
FLAG Output Low Voltage	V_{FLAG-L}	$C_{IN} = 10\mu F$, $I_{SINK} = 2mA$			0.4	V
V_{OUT} shutdown discharge resistance	R_{DIS}	Switch off	250	300	350	Ω
Thermal shutdown temperature	T_{SD}	T_J Increasing		150		$^{\circ}C$
Thermal shutdown hysteresis	T_{SD_HY}			30		$^{\circ}C$

9.6 PARAMETER MEASUREMENT INFORMATION

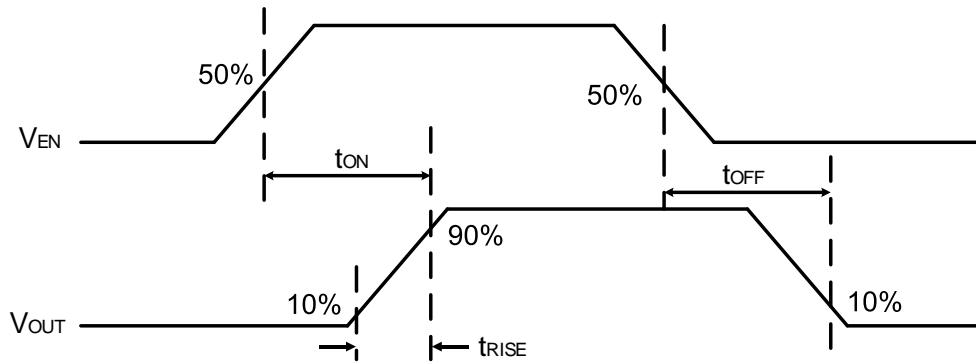

Figure 1. Switch Turn-On and Turn-Off Delay Times

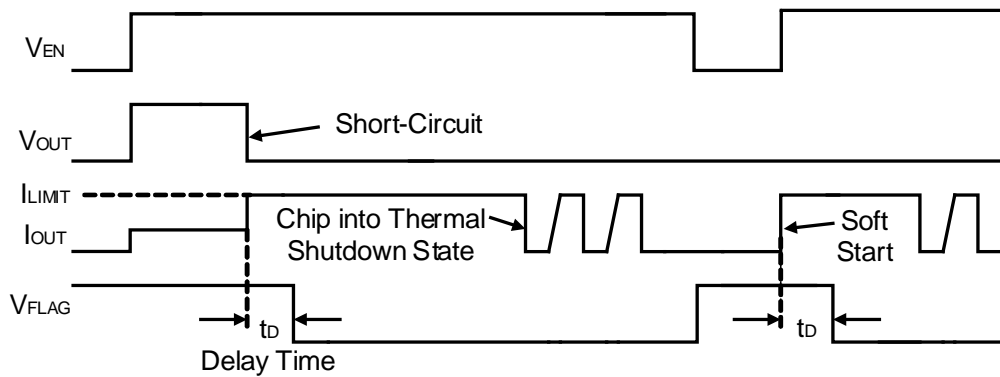

Figure 2. Fault Timing: Output Reset by Toggling EN

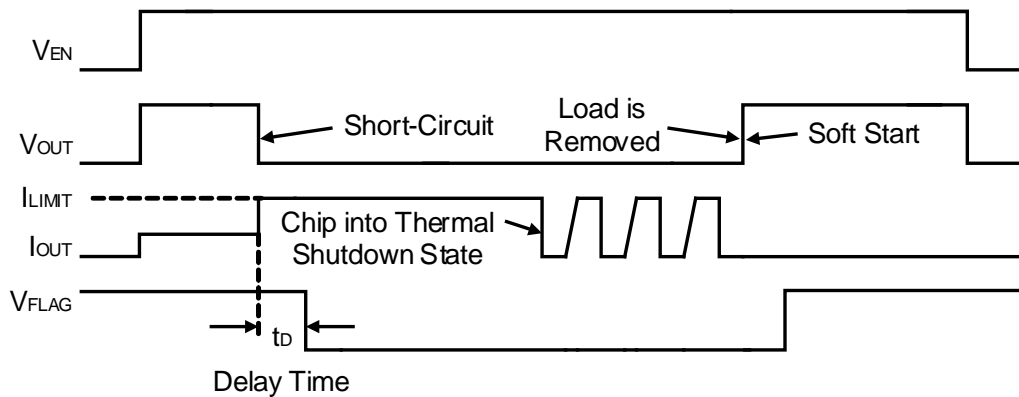

Figure 3. Fault Timing: Output Reset by Removing Load

9.7 Typical Performance Characteristics

$V_{IN} = 5V$, $T_A = +25^\circ C$, unless otherwise noted.

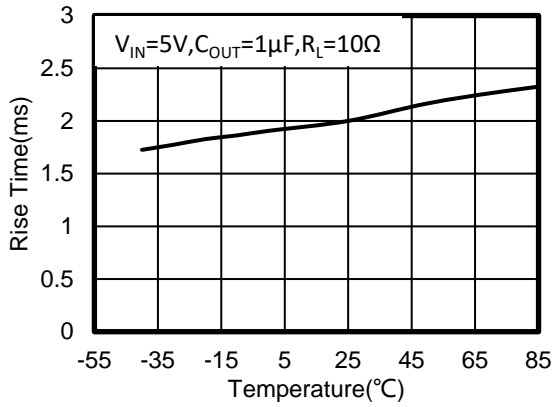

Figure 4. Turn-On Rise Time vs Temperature

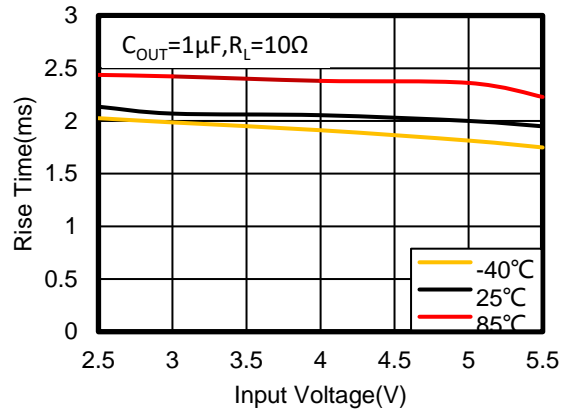

Figure 5. Turn-On Rise Time vs Input Voltage

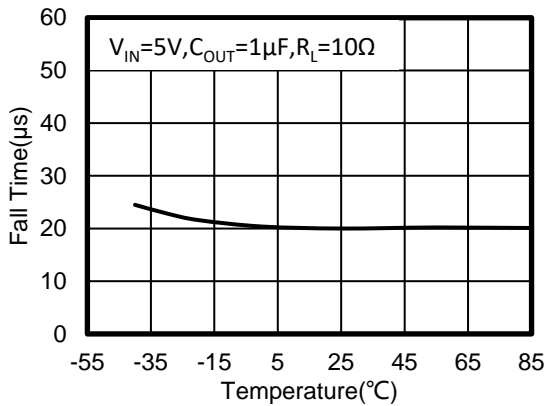

Figure 6. Turn-Off Fall Time vs Temperature

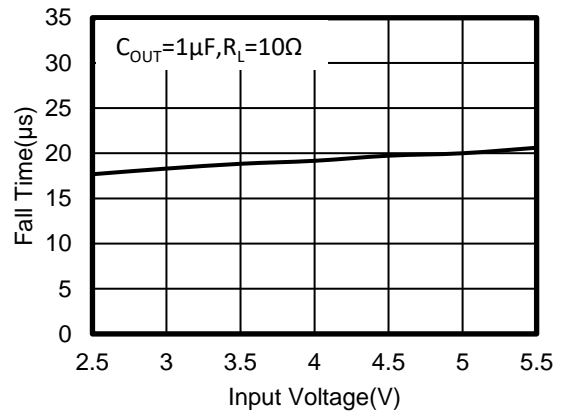

Figure 7. Turn-Off Fall Time vs Input Voltage

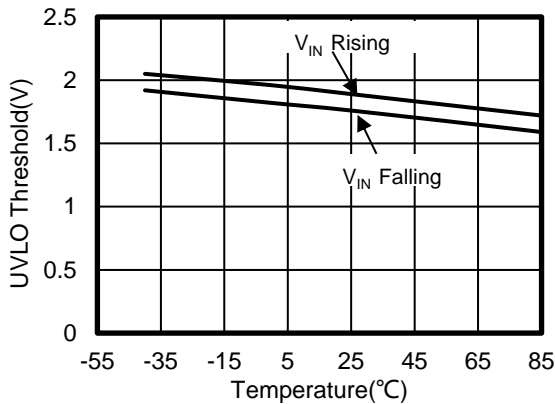

Figure 8. UVLO Threshold vs Temperature

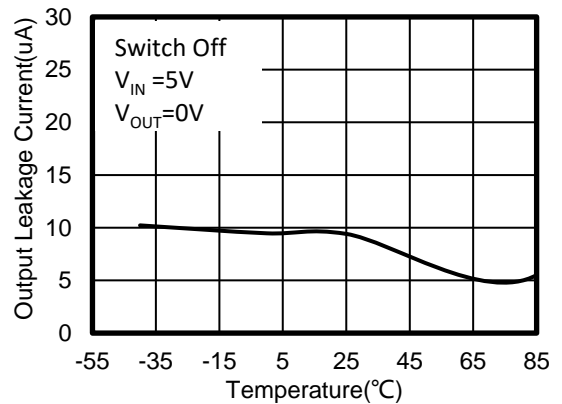

Figure 9. Output Leakage Current vs Temperature

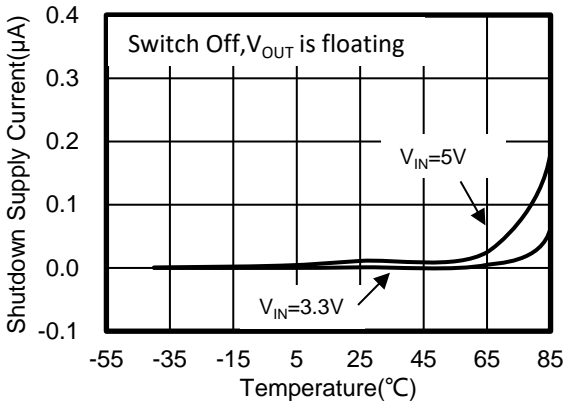

Figure 10. Shutdown Supply Current vs Temperature

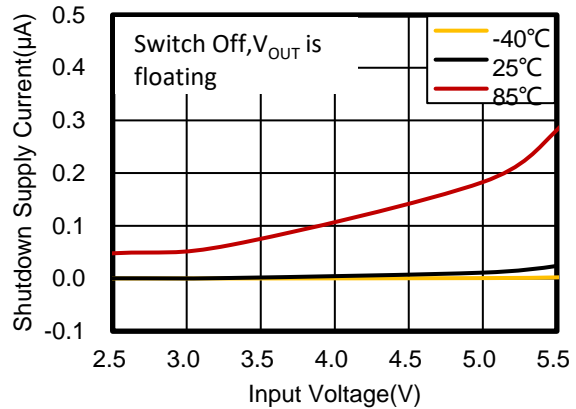

Figure 11. Shutdown Supply Current vs Input Voltage

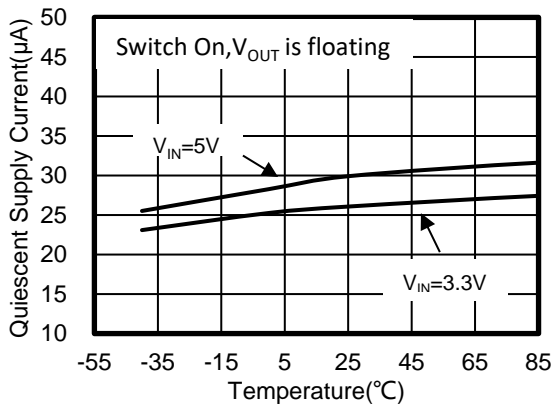

Figure 12. Quiescent Supply Current vs Temperature

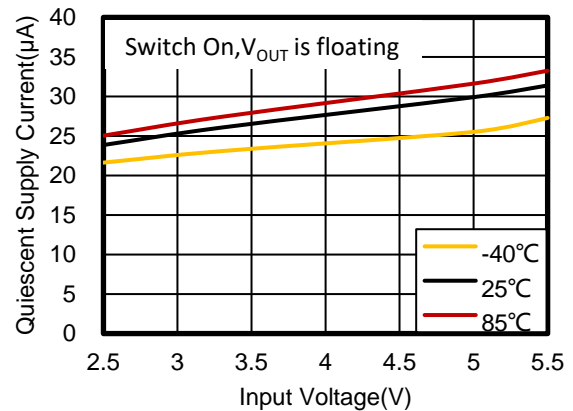

Figure 13. Quiescent Supply Current vs Input Voltage

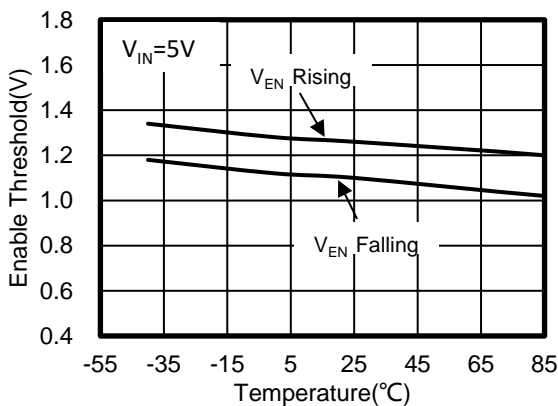

Figure 14. Enable Threshold vs Temperature

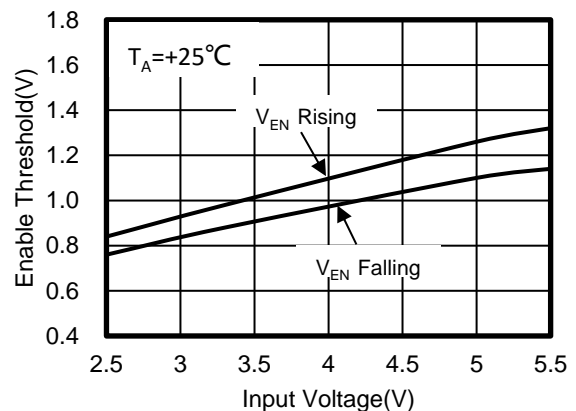

Figure 15. Enable Threshold vs Input Voltage

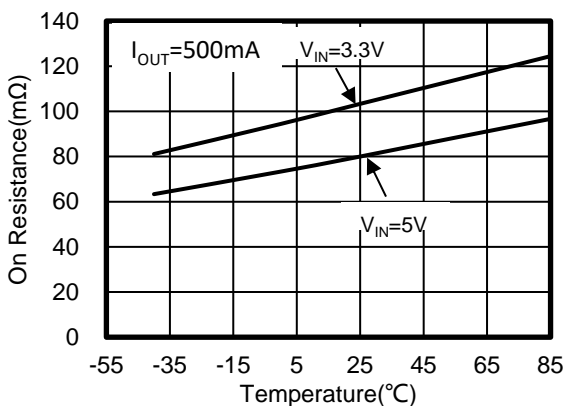

Figure 16. On Resistance vs Temperature

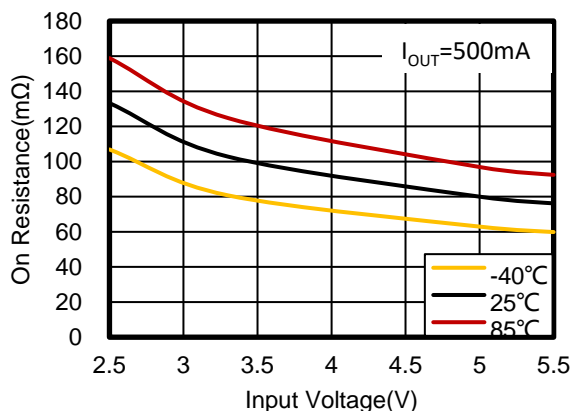

Figure 17. On Resistance vs Input Voltage

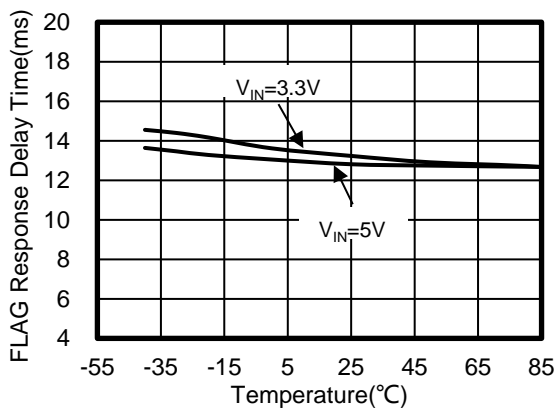

Figure 18. FLAG Response Delay Time vs Temperature

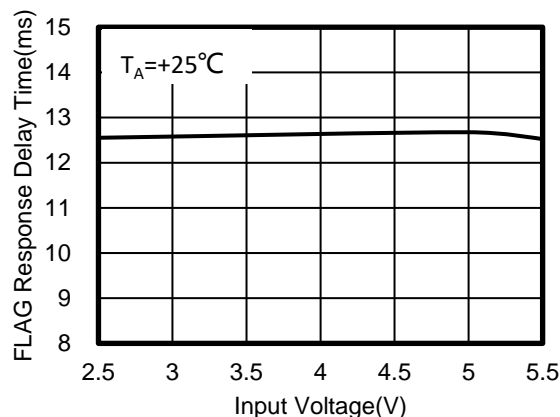

Figure 19. FLAG Response Delay Time vs Input Voltage

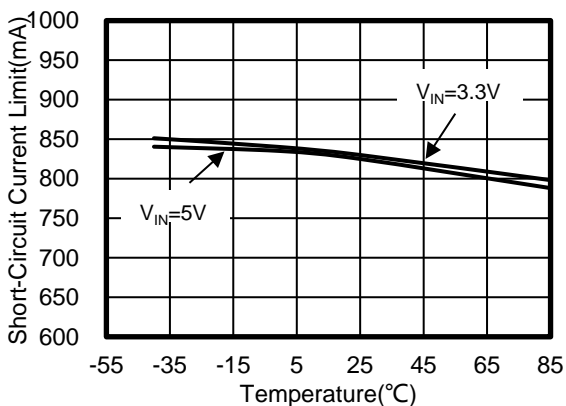

Figure 20. Short-Circuit Current Limit vs Temperature

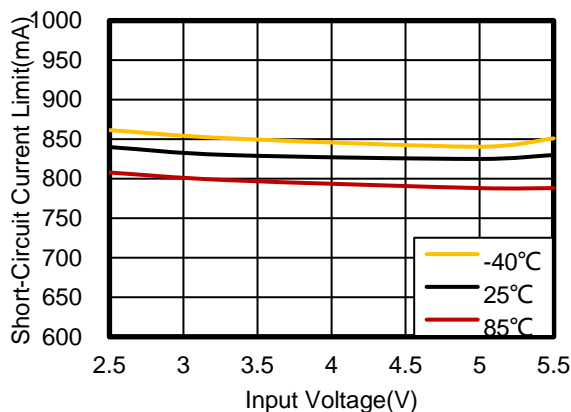

Figure 21. Short-Circuit Current Limit vs Input Voltage

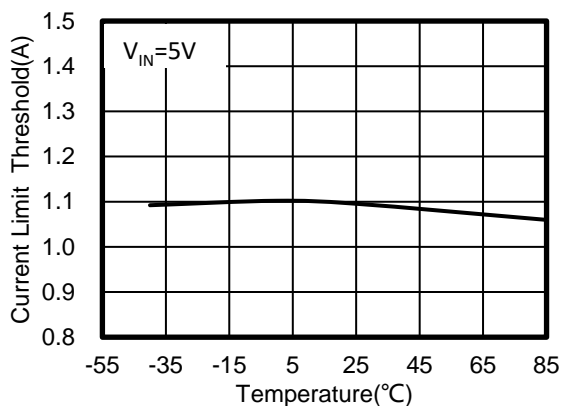

Figure 22. Current Limit Threshold vs Temperature

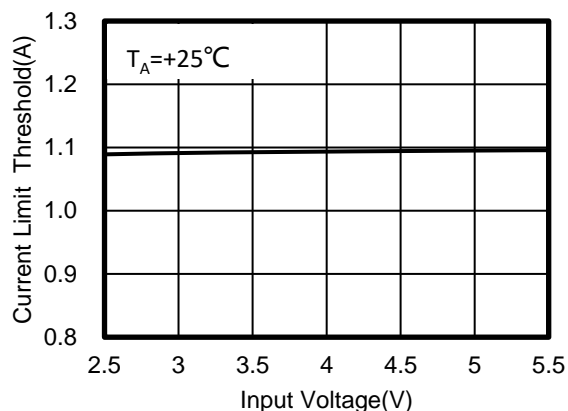

Figure 23. Current Limit Threshold vs Input Voltage

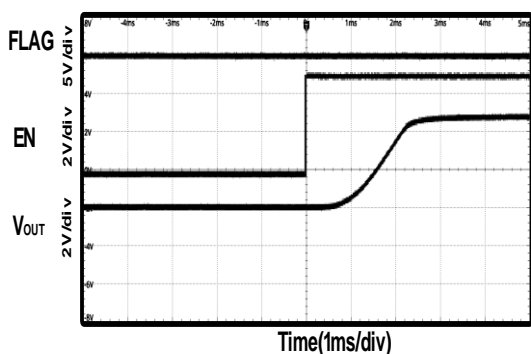

Figure 24. Turn-On Response

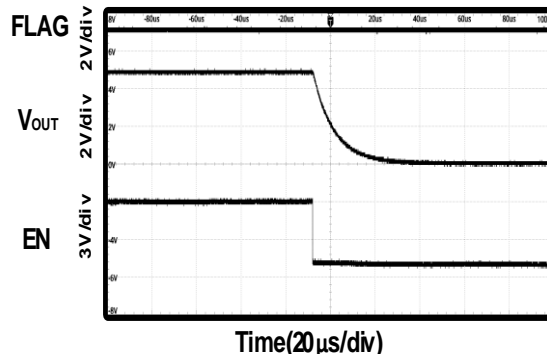

Figure 25. Turn-Off Response

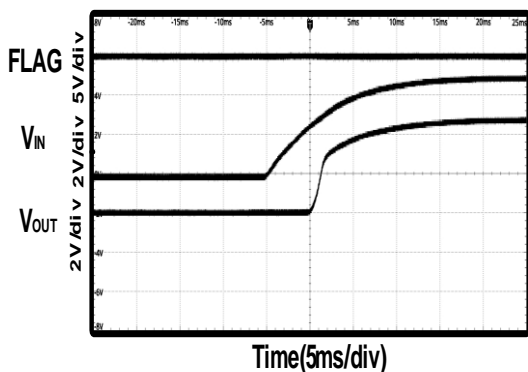

Figure 26. UVLO at V_{IN} Rising

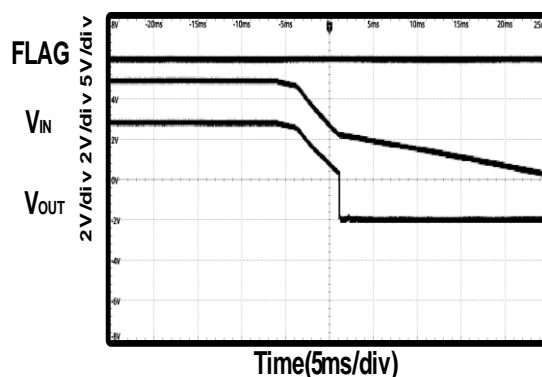

Figure 27. UVLO at V_{IN} Falling

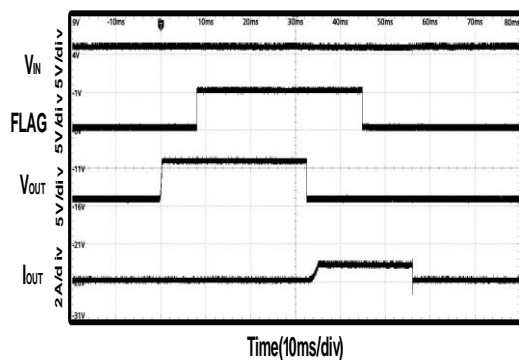

Figure 28. No Load into Short-Circuit

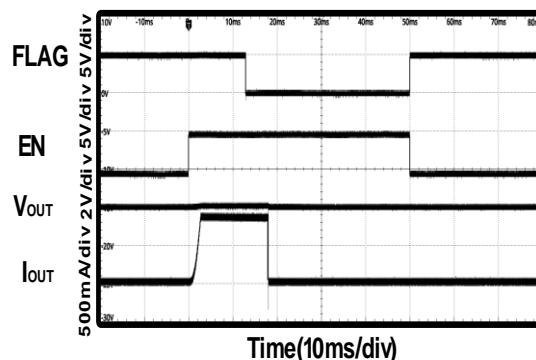

Figure 29. Device Enabled into Short-Circuit

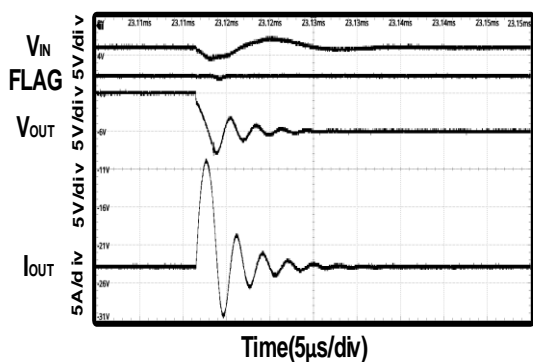

Figure 30. Short-Circuit Response Time

10 FUNCTIONAL DESCRIPTION

10.1 Input and output

V_{IN} is the power supply connection to the logic circuitry and the source of the P-channel MOSFET. V_{OUT} is the drain of the P-channel MOSFET. In a typical circuit, current flows from V_{IN} to V_{OUT} toward the load. The output P-channel MOSFET and driver circuit are also designed to allow the MOSFET drain to be externally forced to a higher voltage than the source (V_{OUT} > V_{IN}) when the switch is disabled.

10.2 Thermal Shutdown

Thermal shutdown is employed to protect device and load from damage. It shuts off the output MOSFET and asserts the FLAG output, if the die temperature exceeds 150°C until the die temperature drops to 130°C.

10.3 Soft-Start

In order to eliminate the upstream voltage sag caused by the large inrush current during hot-plug events, the soft-start feature effectively isolates power supplies from such highly capacitive loads.

10.4 Current limiting and Short protection

The current limit circuit is designed to limit the output current to protect the upstream power supply. The typical current limit threshold is set by internally to approximately 1.1A, 2.1A and 2.6A. Under output short-circuit condition, the typical current limit folded back 75%. If the chip keeps at over-current condition for a long time, the junction temperature may exceed 150°C, and over-temperature protection will shut down the output until temperature drops below 130°C or limit (short) condition is removed.

10.5 Reverse-voltage protection

The reverse-voltage protection feature turns off the P-MOSFET switch whenever the output voltage exceeds the input voltage by 40mV.

10.6 FLAG output

The FLAG signal is an open-drain output pin. FLAG is asserted when an over-current or thermal shutdown condition occurs, and active low output.

In the case of an over-current condition, FLAG will be asserted only after the response delay time (t_D) has elapsed. This ensures that FLAG is asserted only upon valid over-current conditions and that erroneous error reporting is eliminated.

For example, false over-current conditions can occur during hot-plug events when a highly capacitive load is connected and causes a high transient inrush current that exceeds the current limit threshold for up to 1ms, The FLAG response delay time t_D is about 13ms.

10.7 Power dissipation

The device's junction temperature depends on several factors such as the load, PCB layout, ambient temperature, and package type. Equations that can be used to calculate power dissipation and junction temperature are found below:

$$P_D = R_{DS(ON)} \times I_{OUT}^2$$

To relate this to junction temperature, the following equation can be used:

$$T_J = P_D \times \theta_{JA} + T_A$$

Where:

T_J = junction temperature

T_A = ambient temperature

θ_{JA} = the thermal resistance of the package

11 APPLICATION INFORMATION

11.1 Supply filter capacitor

In order to prevent the input voltage drooping during hot-plug events, connect a ceramic capacitor C_{IN} from VIN to GND. The C_{IN} is positioned close to VIN and GND of the device. However, higher capacitor values could reduce the voltage sag on the input further. Furthermore, an output short will cause ringing on the input without the input capacitor. It could destroy the internal circuitry when the input transient exceeds 6V which is the absolute maximum supply voltage even for a short duration.

If the upstream supply cable is long or the VIN transient exceeds 6V during the VOUT short, recommend adding a second filter capacitor (not less than 47 μ F) at the upstream supply output terminal.

11.2 Output filter capacitor

Between VOUT and GND, connect a at least 1 μ F low-ESR ceramic capacitor is recommended. Standard bypass methods should be used to minimize inductance and resistance between the bypass capacitor and the down-stream connector. This will reduce EMI and improve the transient performance.

11.3 PCB layout guide

For best performance of the RS2588, the following guidelines must be strictly followed:

- 1) Keep all power line as short and wide as possible and use at least 1-ounce copper for all power line.
- 2) Dual low-ESR 10 μ F ceramic capacitors between VOUT and GND, VIN and GND.
- 3) Locate the output capacitor as close to the connectors as possible to lower impedance between the port and the capacitor and improve transient performance.
- 4) Input and output capacitors should be placed closed to the chip and connected to ground plane to reduce noise coupling.
- 5) Locate the ceramic bypass capacitors as close as possible to the VIN pin and VOUT pin.

12 PACKAGE OUTLINE DIMENSIONS

SOT23-5

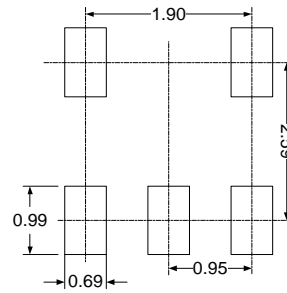
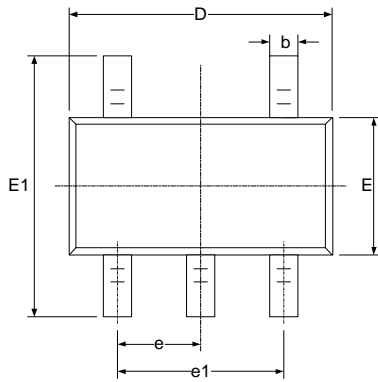

RECOMMENDED LAND PATTERN (Unit: mm)

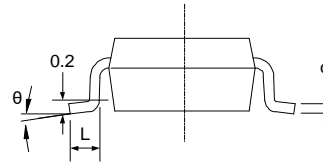
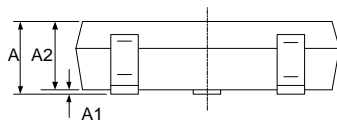

Symbol	Dimensions In Millimeters		Dimensions In Inches	
	Min	Max	Min	Max
A	1.050	1.250	0.041	0.049
A1	0.000	0.100	0.000	0.004
A2	1.050	1.150	0.041	0.045
b	0.300	0.500	0.012	0.020
c	0.100	0.200	0.004	0.008
D	2.820	3.020	0.111	0.119
E	1.500	1.700	0.059	0.067
E1	2.650	2.950	0.104	0.116
e	0.950 (BSC)		0.037 (BSC)	
e1	1.800	2.000	0.071	0.079
L	0.300	0.600	0.012	0.024
θ	0°	8°	0°	8°

13 TAPE AND REEL INFORMATION

REEL DIMENSIONS

TAPE DIMENSION

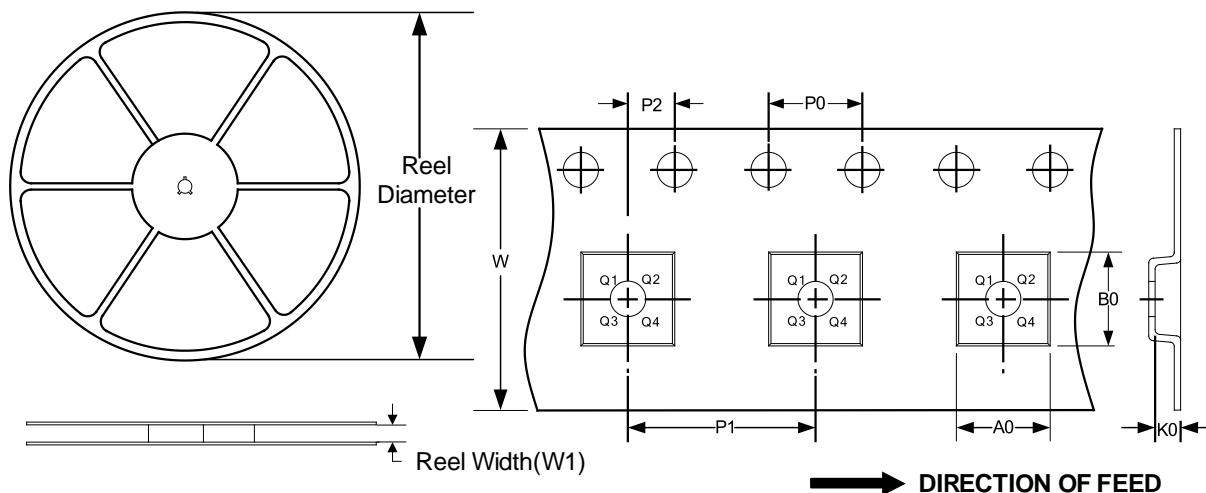

NOTE: The picture is only for reference. Please make the object as the standard.

KEY PARAMETER LIST OF TAPE AND REEL

Package Type	Reel Diameter	Reel Width (mm)	A0 (mm)	B0 (mm)	K0 (mm)	P0 (mm)	P1 (mm)	P2 (mm)	W (mm)	Pin1 Quadrant
SOT23-5	7"	9.5	3.20	3.20	1.40	4.0	4.0	2.0	8.0	Q3

X-ON Electronics

Largest Supplier of Electrical and Electronic Components

Click to view similar products for [Power Switch ICs - Power Distribution](#) category:

Click to view products by [RUNIC](#) manufacturer:

Other Similar products are found below :

[TLE6232GP](#) [NCP45520IMNTWG-L](#) [FPF1018](#) [DS1222](#) [NCV380HMUAJAATBG](#) [TCK2065G,LF](#) [SZNCP3712ASNT3G](#)
[NCP45520IMNTWG-H](#) [VND5004ATR-E](#) [ITS5215LXT](#) [AP22811BW5-7](#) [SLG5NT1437VTR](#) [SZNCP3712ASNT1G](#) [DML1008LDS-7](#)
[KTS1640QGDV-TR](#) [KTS1641QGDV-TR](#) [NCV459MNWTBG](#) [NCP4545IMNTWG-L](#) [FPF2260ATMX](#) [SLG5NT1765V](#) [SLG5NT1757V](#)
[NCP45780IMN24RTWG](#) [AP2151AMP-13](#) [NCP45540IMNTWG-L](#) [TPS2022P](#) [FPF2495BUCX](#) [NCP45650IMNTWG](#) [NCV8412ADDR2G](#)
[DK5V100R20S](#) [JW7111SSOTB#TRPBF](#) [RY2121](#) [TPNTGD1100LT1G](#) [TPS27081ADDCR-TP](#) [FDC6331L-TP](#) [FDC6329L-TP](#) [FDC6323L-](#)
[TP](#) [SI3865DDV](#) [TPS2116DRLR](#) [U3213](#) [BTS7020-2EPA](#) [BTT6100-2ERA](#) [BTS71220-4ESA](#) [RS2588CYF5](#) [RS2580XTDE8](#) [LP5308B6F](#)
[ME1502AM5G](#) [SGM2576YN5G/TR](#) [DK5V100R15M](#) [SY6287CDEC](#) [BSP75N](#)