

# 150mA, Ultralow Power Consumption, High Voltage CMOS LDO Regulator

## FEATURES

- **Ultralow Quiescent Current  $I_Q$ :**  
2.5 $\mu$ A Typical at Light Loads  
5 $\mu$ A Maximum at Light Loads
- **150mA Nominal Output Current**
- **Low Dropout Voltage**
- **Low Temperature Coefficient**
- **High Input Voltage (up to 36V)**
- **Output Voltage Accuracy:**  
 $\pm 2.5\%$  (Max at 25°C)  
 $\pm 1.0\%$  (Class A Max at 25°C)
- **Fixed 3.0V、3.3V、3.6V and 5.0V Output Voltage**
- **Operating Temperature Range:**  
-40°C to +85°C
- **Micro SIZE PACKAGES: SOT23-3、SOT23、SOT89-3L and SOT89-3L(L-Type)**

## APPLICATIONS

- Audio/Video Equipment
- Communication Equipment
- Battery-Powered Equipment
- Automotive Head Unit
- Laptop, Palmtops, Notebook Computers

## DESCRIPTION

The RS3002 series is a set of low power high voltage regulators implemented in CMOS technology. It can operate from 2.5V to 36V. Which can provide 150mA output current. The device allows input voltage as high as 36V.

The RS3002 series is available in several fixed output voltages. CMOS technology ensures low dropout voltage and ultralow quiescent current.

The RS3002 is available in Green SOT23-3, SOT23 and SOT89-3L packages. It operates over an ambient temperature range of -40°C to +85°C.

**Device Information (1)**

| PART NUMBER | PACKAGE     | BODY SIZE (NOM) |
|-------------|-------------|-----------------|
| RS3002      | SOT23-3(3)  | 1.60mm × 2.92mm |
|             | SOT23(3)    | 1.30mm × 2.92mm |
|             | SOT23-5(5)  | 1.60mm × 2.92mm |
|             | SOT89-3L(3) | 2.45mm × 4.50mm |
|             | TO-92(3)    | 4.60mm × 4.60mm |

(1) For all available packages, see the orderable addendum at the end of the data sheet.

**Typical Application Schematic**

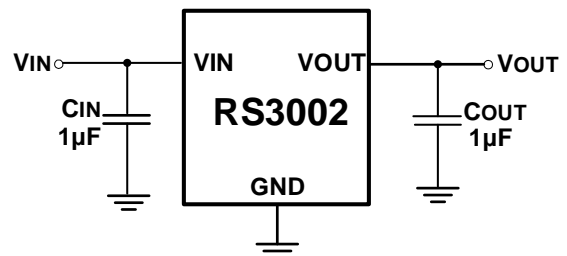

## Pin Configuration and Functions (Top View)

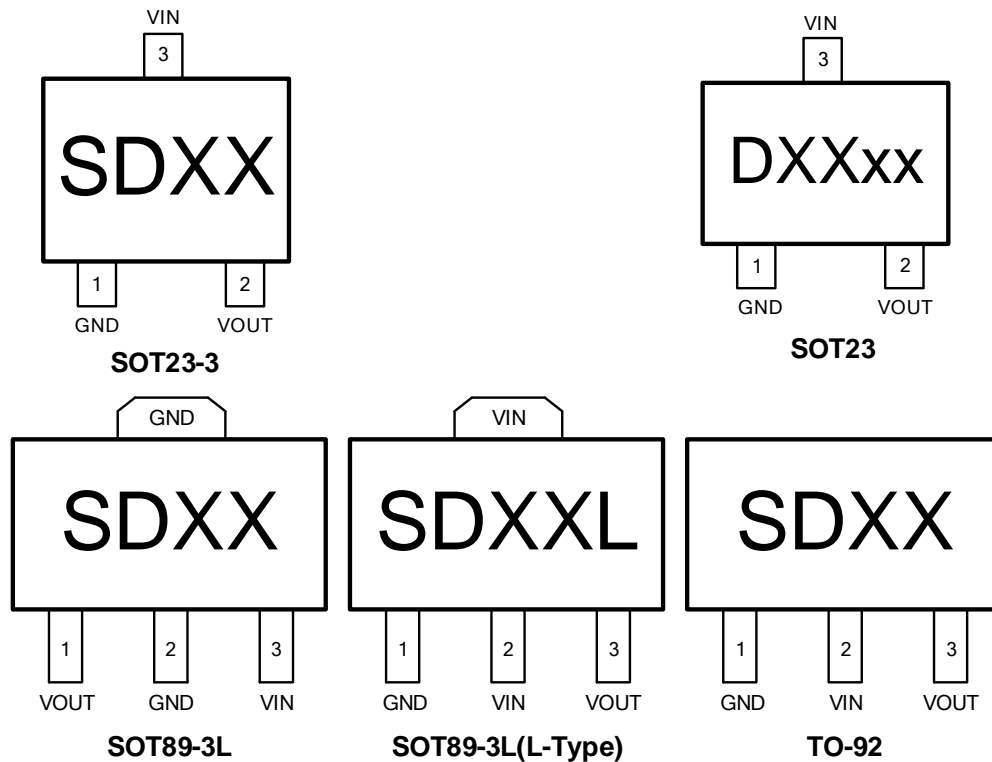

NOTE: XX indicate Output Voltage, xx indicate Data Code  
 For example: SD33 ( $V_{OUT}=3.3V$ )

## PIN DESCRIPTION

| NAME | PIN     |       |          |                          | FUNCTION                                                                                             |
|------|---------|-------|----------|--------------------------|------------------------------------------------------------------------------------------------------|
|      | SOT23-3 | SOT23 | SOT89-3L | SOT89-3L (L-Type) /TO-92 |                                                                                                      |
| GND  | 1       | 1     | 2        | 1                        | Ground.                                                                                              |
| VOUT | 2       | 2     | 1        | 3                        | Regulator Output. Recommended output capacitor range:1 $\mu$ F to 10 $\mu$ F.                        |
| VIN  | 3       | 3     | 3        | 2                        | Regulator Input. Up to 36V input voltage. At least 1 $\mu$ F supply bypass capacitor is recommended. |

Pin Configuration and Functions (Top View)

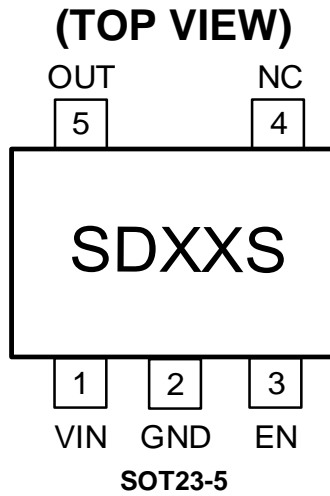

| SOT23-5 |      | I/O | DESCRIPTION                                                                                                                               |
|---------|------|-----|-------------------------------------------------------------------------------------------------------------------------------------------|
| NUMBER  | NAME |     |                                                                                                                                           |
| 1       | VIN  | I   | Regulator Input. Up to 36V input voltage. At least 1μF supply bypass capacitor is recommended.                                            |
| 2       | GND  | G   | Ground.                                                                                                                                   |
| 3       | EN   | I   | Enable pin. Drive EN greater than $V_{EN(H)}$ to turn on the regulator. Drive EN less than $V_{EN(L)}$ to put the LDO into shutdown mode. |
| 4       | NC   | -   | Not connect                                                                                                                               |
| 5       | OUT  | O   | Regulator Output. Recommended output capacitor range:1μF to 10μF.                                                                         |

**PACKAGE/ORDERING INFORMATION**

| PRODUCT    | ORDERING NUMBER | V <sub>OUT</sub> (V) | V <sub>OUT</sub> Accuracy | PACKAGE LEAD         | PACKAGE MARKING | PACKAGE OPTION     |
|------------|-----------------|----------------------|---------------------------|----------------------|-----------------|--------------------|
| RS3002-3.0 | RS3002-3.0YF3   | 3.0                  | ±2.5%                     | SOT23-3              | SD30<br>XXXX    | Tape and Reel,3000 |
|            | RS3002-3.0SYF5  | 3.0                  | ±2.5%                     | SOT23-5              | SD30S<br>XXXX   | Tape and Reel,3000 |
|            | RS3002-3.0ASYF5 | 3.0                  | ±1.0%                     | SOT23-5              | SD30S<br>XXXX   | Tape and Reel,3000 |
|            | RS3002-3.0YSF3  | 3.0                  | ±2.5%                     | SOT23                | D30XX           | Tape and Reel,3000 |
|            | RS3002-3.0YE3   | 3.0                  | ±2.5%                     | SOT89-3L             | SD30<br>XXXX    | Tape and Reel,1000 |
|            | RS3002-3.0YE3L  | 3.0                  | ±2.5%                     | SOT89-3L<br>(L-Type) | SD30L<br>XXXX   | Tape and Reel,1000 |
| RS3002-3.3 | RS3002-3.3YF3   | 3.3                  | ±2.5%                     | SOT23-3              | SD33<br>XXXX    | Tape and Reel,3000 |
|            | RS3002-3.3SYF5  | 3.3                  | ±2.5%                     | SOT23-5              | SD33S<br>XXXX   | Tape and Reel,3000 |
|            | RS3002-3.3ASYF5 | 3.3                  | ±1.0%                     | SOT23-5              | SD33S<br>XXXX   | Tape and Reel,3000 |
|            | RS3002-3.3YSF3  | 3.3                  | ±2.5%                     | SOT23                | D33XX           | Tape and Reel,3000 |
|            | RS3002-3.3YE3   | 3.3                  | ±2.5%                     | SOT89-3L             | SD33<br>XXXX    | Tape and Reel,1000 |
|            | RS3002-3.3YE3L  | 3.3                  | ±2.5%                     | SOT89-3L<br>(L-Type) | SD33L<br>XXXX   | Tape and Reel,1000 |
| RS3002-3.6 | RS3002-3.6YF3   | 3.6                  | ±2.5%                     | SOT23-3              | SD36<br>XXXX    | Tape and Reel,3000 |
|            | RS3002-3.6SYF5  | 3.6                  | ±2.5%                     | SOT23-5              | SD36S<br>XXXX   | Tape and Reel,3000 |
|            | RS3002-3.6YSF3  | 3.6                  | ±2.5%                     | SOT23                | D36XX           | Tape and Reel,3000 |
|            | RS3002-3.6YE3   | 3.6                  | ±2.5%                     | SOT89-3L             | SD36<br>XXXX    | Tape and Reel,1000 |
|            | RS3002-3.6YE3L  | 3.6                  | ±2.5%                     | SOT89-3L<br>(L-Type) | SD36L<br>XXXX   | Tape and Reel,1000 |
| RS3002-5.0 | RS3002-5.0YF3   | 5.0                  | ±2.5%                     | SOT23-3              | SD50<br>XXXX    | Tape and Reel,3000 |
|            | RS3002-5.0SYF5  | 5.0                  | ±2.5%                     | SOT23-5              | SD50S<br>XXXX   | Tape and Reel,3000 |
|            | RS3002-5.0YSF3  | 5.0                  | ±2.5%                     | SOT23                | D50XX           | Tape and Reel,3000 |
|            | RS3002-5.0AYSF3 | 5.0                  | ±1.0%                     | SOT23                | D50XX           | Tape and Reel,3000 |
|            | RS3002-5.0YE3   | 5.0                  | ±2.5%                     | SOT89-3L             | SD50<br>XXXX    | Tape and Reel,1000 |
|            | RS3002-5.0YE3L  | 5.0                  | ±2.5%                     | SOT89-3L<br>(L-Type) | SD50L<br>XXXX   | Tape and Reel,1000 |
|            | RS3002-5.0YT3   | 5.0                  | ±2.5%                     | TO-92                | SD50<br>XXXX    | Tape and Reel,2000 |

NOTE: XXXX = Date Code and Vendor Code.

## Specifications

### Absolute Maximum Ratings

over operating free-air temperature range (unless otherwise noted) <sup>(1)(2)</sup>

|                  |                                             | MIN                | MAX             | UNIT |
|------------------|---------------------------------------------|--------------------|-----------------|------|
| V <sub>IN</sub>  | Input voltage                               | -0.3               | 45              | V    |
| V <sub>EN</sub>  | Enable input voltage                        | -0.3               | V <sub>IN</sub> | V    |
| T <sub>J</sub>   | Junction temperature                        | -40                | 150             | °C   |
| P <sub>D</sub>   | Continuous power dissipation <sup>(3)</sup> | Internally Limited |                 | W    |
| T <sub>stg</sub> | Storage temperature                         | -65                | 150             | °C   |

(1) Stresses beyond those listed under *Absolute Maximum Ratings* may cause permanent damage to the device. These are stress ratings only, and functional operation of the device at these or any other conditions beyond those indicated under *Recommended Operating Conditions* is not implied. Exposure to absolute-maximum-rated conditions for extended periods may affect device reliability.

(2) All voltages are with respect to the GND pin.

(3) Internal thermal shutdown circuitry protects the device from permanent damage.

### ESD Ratings

|                    |                         | VALUE                  | UNIT  |   |
|--------------------|-------------------------|------------------------|-------|---|
| V <sub>(ESD)</sub> | Electrostatic discharge | Human-body model (HBM) | ±1000 | V |
|                    |                         | Machine model (MM)     | ±100  | V |

### Recommended Operating Conditions

over operating free-air temperature range (unless otherwise noted) <sup>(1)</sup>

|                 |                       | MIN | MAX | UNIT |
|-----------------|-----------------------|-----|-----|------|
| V <sub>IN</sub> | Input supply voltage  | 2.5 | 36  | V    |
| V <sub>EN</sub> | Enable voltage        | 0   | 36  | V    |
| T <sub>A</sub>  | Operating temperature | -40 | +85 | °C   |

(1) All voltages are with respect to the GND pin.

### Thermal Information

| THERMAL METRIC (1)    |                                              | RS3002                        | RS3002   | RS3002               | RS3002 | UNIT |
|-----------------------|----------------------------------------------|-------------------------------|----------|----------------------|--------|------|
|                       |                                              | SOT23/<br>SOT23-3/<br>SOT23-5 | SOT89-3L | SOT89-3L<br>(L-Type) | TO-92  |      |
|                       |                                              | 3 PINS/<br>5 PINS             | 3 PINS   | 3 PINS               | 3 PINS |      |
| R <sub>θJA</sub>      | Junction-to-ambient thermal resistance       | 185.6                         | 75       | 165                  | 143.6  | °C/W |
| R <sub>θJC(top)</sub> | Junction-to-case (top) thermal resistance    | 104.3                         | 88.1     | 88.5                 | 74.4   | °C/W |
| R <sub>θJB</sub>      | Junction-to-board thermal resistance         | 54.5                          | 9.6      | 39.6                 | —      | °C/W |
| ψ <sub>JT</sub>       | Junction-to-top characterization parameter   | 31.0                          | 6.2      | 26.5                 | 24.2   | °C/W |
| ψ <sub>JB</sub>       | Junction-to-board characterization parameter | 54.5                          | 9.7      | 49.7                 | 120.9  | °C/W |
| R <sub>JC(bot)</sub>  | Junction-to-case (bottom) thermal resistance | N/A                           | 7.7      | 77.7                 | —      | °C/W |

## ELECTRICAL CHARACTERISTICS

( $V_{IN} = V_{OUT} + 2V$ ,  $C_{IN} = C_{OUT} = 1\mu F$ ,  $V_{OUT} = 3.3V$ , Full =  $-40^{\circ}C$  to  $+85^{\circ}C$ , typical values are at  $T_A = +25^{\circ}C$ , unless otherwise noted.)

| PARAMETER                                             | SYMBOL                                                | CONDITIONS                                         | TEMP           | MIN                     | TYP   | MAX            | UNITS            |         |
|-------------------------------------------------------|-------------------------------------------------------|----------------------------------------------------|----------------|-------------------------|-------|----------------|------------------|---------|
| Input Voltage                                         | $V_{IN}$                                              | $V_{OUT} = 3.3V$                                   | $+25^{\circ}C$ | 2.5 <sup>(1)</sup>      |       | 36             | V                |         |
| Output Voltage Accuracy                               |                                                       | $I_{OUT} = 1mA$                                    | $+25^{\circ}C$ | -2.5                    | 0     | 2.5            | %                |         |
|                                                       |                                                       | $I_{OUT} = 1mA$ , Class A                          | $+25^{\circ}C$ | -1.0                    | 0     | 1.0            | %                |         |
| Ground Pin Current                                    |                                                       | No load                                            | $+25^{\circ}C$ | $V_{IN} = V_{OUT} + 2V$ |       | 2.5            | 5                | $\mu A$ |
|                                                       |                                                       |                                                    |                | $V_{IN} = 36V$          |       | 5.0            | 8                |         |
|                                                       |                                                       | $I_{OUT} = 50mA$                                   |                |                         | 2.5   |                |                  |         |
| Maximum Output Current <sup>(2)</sup>                 |                                                       |                                                    | $+25^{\circ}C$ | 150                     |       |                | mA               |         |
| Dropout Voltage <sup>(3)</sup>                        | $V_{DROP}$                                            | $I_{OUT} = 150mA$                                  | $+25^{\circ}C$ |                         | 1200  | 1800           | mV               |         |
| Line Regulation                                       | $\frac{\Delta V_{OUT}}{\Delta V_{IN} \times V_{OUT}}$ | $V_{IN} = V_{OUT} + 2V$ to 36V, $I_{OUT} = 1mA$    | $+25^{\circ}C$ |                         | 0.001 | 0.012          | %/V              |         |
| Load Regulation                                       | $\Delta V_{OUT}$                                      | $V_{IN} = V_{OUT} + 2V$ , $I_{OUT} = 1mA$ to 150mA | $+25^{\circ}C$ |                         | 11    | 20             | mV               |         |
| Power Supply Rejection Ratio                          | PSRR                                                  | $V_{OUT} = 3.3V$ ,<br>$I_{OUT} = 10mA$             | $+25^{\circ}C$ | $f = 217Hz$             |       | 57             | dB               |         |
|                                                       |                                                       |                                                    |                | $f = 1KHz$              |       | 54             |                  |         |
| Output Voltage Temperature Coefficient <sup>(4)</sup> | $\frac{\Delta V_{OUT}}{\Delta T_A \times V_{OUT}}$    | $I_{OUT} = 1mA$                                    | FULL           |                         | 70    |                | ppm/ $^{\circ}C$ |         |
| <b>THERMAL PROTECTION</b>                             |                                                       |                                                    |                |                         |       |                |                  |         |
| Thermal Shutdown Temperature                          | $T_{SHDN}$                                            |                                                    |                |                         | 120   |                | $^{\circ}C$      |         |
| <b>SHUTDOWN</b>                                       |                                                       |                                                    |                |                         |       |                |                  |         |
| EN Voltage Range                                      | $V_{EN}$                                              |                                                    | FULL           | -0.3                    |       | $V_{IN} + 0.3$ | V                |         |
| EN Input Threshold                                    | $V_{IH}$                                              | $V_{IN} = V_{OUT} + 2V$ to 36V                     | FULL           | 1.1                     |       |                | V                |         |
|                                                       | $V_{IL}$                                              | $V_{IN} = V_{OUT} + 2V$ to 36V                     | FULL           |                         |       | 0.4            |                  |         |
| EN Input Bias Current                                 | $I_{BH}$                                              | EN=36V                                             | $+25^{\circ}C$ |                         | 0.01  | 1              | $\mu A$          |         |
|                                                       | $I_{BL}$                                              | EN=0V                                              | FULL           |                         | 0.01  | 1              |                  |         |
| Shutdown Supply Current                               | $I_{Q(SHDN)}$                                         | EN=0V                                              | FULL           |                         | 1.0   | 2              | $\mu A$          |         |
| Start-Up Time <sup>(5)</sup>                          | $t_{STR}$                                             | $C_{OUT} = 1\mu F$ , No Load                       | $+25^{\circ}C$ |                         | 230   |                | $\mu s$          |         |

### NOTES:

- $V_{IN} = V_{OUT}$  (NOMINAL) or 2.5V, whichever is greater.
- Maximum output current is affected by the PCB layout, size of metal trace, the thermal conduction path between metal layers, ambient temperature and the other environment factors of system. Attention should be paid to the dropout voltage when  $V_{IN} < V_{OUT} + V_{DROP}$ .
- The dropout voltage is defined as  $V_{IN} - V_{OUT}$ , when  $V_{OUT}$  is 100mV below the value of  $V_{OUT}$  for  $V_{IN} = V_{OUT}$  (NOMINAL) + 2V.
- Output voltage temperature coefficient is defined as the worst-case voltage change divided by the total temperature range.
- Time needed for  $V_{OUT}$  to reach 90% of final value.

## ELECTRICAL CHARACTERISTICS

( $V_{IN} = V_{OUT} + 2V$ ,  $C_{IN} = C_{OUT} = 1\mu F$ ,  $V_{OUT} = 5.0V$ , Full =  $-40^{\circ}C$  to  $+85^{\circ}C$ , typical values are at  $T_A = +25^{\circ}C$ , unless otherwise noted.)

| PARAMETER                                             | SYMBOL                                                | CONDITIONS                                         | TEMP           | MIN                     | TYP   | MAX            | UNITS            |         |
|-------------------------------------------------------|-------------------------------------------------------|----------------------------------------------------|----------------|-------------------------|-------|----------------|------------------|---------|
| Input Voltage                                         | $V_{IN}$                                              | $V_{OUT} = 5.0V$                                   | $+25^{\circ}C$ | 2.5 <sup>(1)</sup>      |       | 36             | V                |         |
| Output Voltage Accuracy                               |                                                       | $I_{OUT} = 1mA$                                    | $+25^{\circ}C$ | -2.5                    | 0     | 2.5            | %                |         |
|                                                       |                                                       | $I_{OUT} = 1mA$ , Class A                          | $+25^{\circ}C$ | -1.0                    | 0     | 1.0            | %                |         |
| Ground Pin Current                                    |                                                       | No load                                            | $+25^{\circ}C$ | $V_{IN} = V_{OUT} + 2V$ |       | 2.5            | 5                | $\mu A$ |
|                                                       |                                                       |                                                    |                | $V_{IN} = 36V$          |       | 5.0            | 8                |         |
|                                                       |                                                       | $I_{OUT} = 50mA$                                   |                | 2.5                     |       |                |                  |         |
| Maximum Output Current <sup>(2)</sup>                 |                                                       |                                                    | $+25^{\circ}C$ | 150                     |       |                | mA               |         |
| Dropout Voltage <sup>(3)</sup>                        | $V_{DROP}$                                            | $I_{OUT} = 150mA$                                  | $+25^{\circ}C$ |                         | 1000  | 1600           | mV               |         |
| Line Regulation                                       | $\frac{\Delta V_{OUT}}{\Delta V_{IN} \times V_{OUT}}$ | $V_{IN} = V_{OUT} + 2V$ to 36V, $I_{OUT} = 1mA$    | $+25^{\circ}C$ |                         | 0.001 | 0.012          | %/V              |         |
| Load Regulation                                       | $\Delta V_{OUT}$                                      | $V_{IN} = V_{OUT} + 2V$ , $I_{OUT} = 1mA$ to 150mA | $+25^{\circ}C$ |                         | 11    | 20             | mV               |         |
| Power Supply Rejection Ratio                          | PSRR                                                  | $V_{OUT} = 5.0V$ ,<br>$I_{OUT} = 10mA$             | $+25^{\circ}C$ | $f = 217Hz$             |       | 57             | dB               |         |
|                                                       |                                                       |                                                    |                | $f = 1KHz$              |       | 54             |                  |         |
| Output Voltage Temperature Coefficient <sup>(4)</sup> | $\frac{\Delta V_{OUT}}{\Delta T_A \times V_{OUT}}$    | $I_{OUT} = 1mA$                                    | FULL           |                         | 70    |                | ppm/ $^{\circ}C$ |         |
| <b>THERMAL PROTECTION</b>                             |                                                       |                                                    |                |                         |       |                |                  |         |
| Thermal Shutdown Temperature                          | $T_{SHDN}$                                            |                                                    |                |                         | 120   |                | $^{\circ}C$      |         |
| <b>SHUTDOWN</b>                                       |                                                       |                                                    |                |                         |       |                |                  |         |
| EN Voltage Range                                      | $V_{EN}$                                              |                                                    | FULL           | -0.3                    |       | $V_{IN} + 0.3$ | V                |         |
| EN Input Threshold                                    | $V_{IH}$                                              | $V_{IN} = V_{OUT} + 2V$ to 36V                     | FULL           | 1.1                     |       |                | V                |         |
|                                                       | $V_{IL}$                                              | $V_{IN} = V_{OUT} + 2V$ to 36V                     | FULL           |                         |       | 0.4            |                  |         |
| EN Input Bias Current                                 | $I_{BH}$                                              | EN=36V                                             | $+25^{\circ}C$ |                         | 0.01  | 1              | $\mu A$          |         |
|                                                       | $I_{BL}$                                              | EN=0V                                              | FULL           |                         | 0.01  | 1              |                  |         |
| Shutdown Supply Current                               | $I_{Q(SHDN)}$                                         | EN=0V                                              | FULL           |                         | 1.0   | 2              | $\mu A$          |         |
| Start-Up Time <sup>(5)</sup>                          | $t_{STR}$                                             | $C_{OUT} = 1\mu F$ , No Load                       | $+25^{\circ}C$ |                         | 230   |                | $\mu s$          |         |

### NOTES:

- $V_{IN} = V_{OUT}$  (NOMINAL) or 2.5V, whichever is greater.
- Maximum output current is affected by the PCB layout, size of metal trace, the thermal conduction path between metal layers, ambient temperature and the other environment factors of system. Attention should be paid to the dropout voltage when  $V_{IN} < V_{OUT} + V_{DROP}$ .
- The dropout voltage is defined as  $V_{IN} - V_{OUT}$ , when  $V_{OUT}$  is 100mV below the value of  $V_{OUT}$  for  $V_{IN} = V_{OUT}$  (NOMINAL) + 2V.
- Output voltage temperature coefficient is defined as the worst-case voltage change divided by the total temperature range.
- Time needed for  $V_{OUT}$  to reach 90% of final value.

## TYPICAL CHARACTERISTICS

$V_{IN} = 5.3V$ ,  $V_{OUT} = 3.3V$ ,  $C_{IN} = C_{OUT} = 1\mu F$ ,  $T_A = 25^\circ C$  unless otherwise noted.

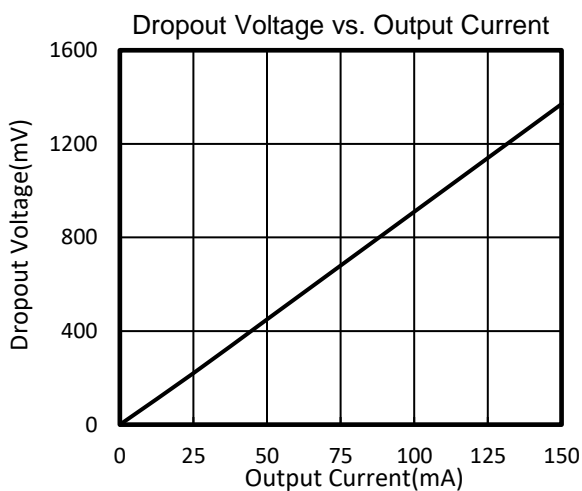
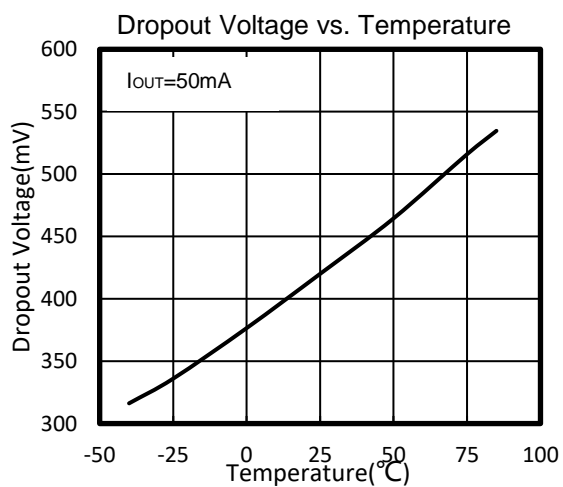
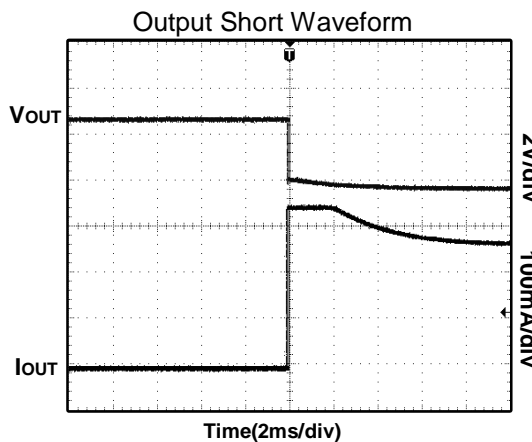
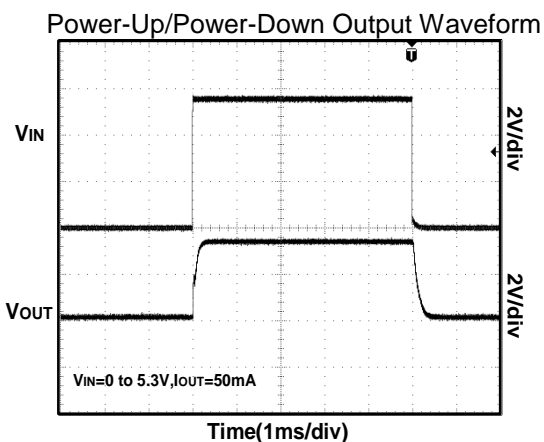
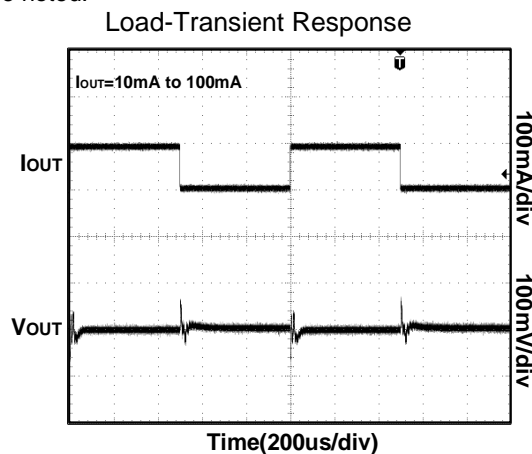
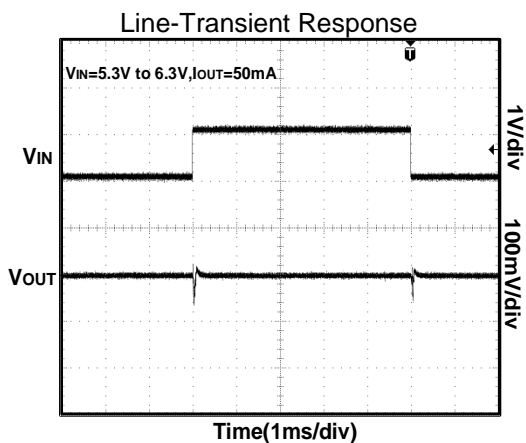



## TYPICAL CHARACTERISTICS

$V_{IN} = 5.3V$ ,  $V_{OUT} = 3.3V$ ,  $C_{IN} = C_{OUT} = 1\mu F$ ,  $T_A = 25^\circ C$  unless otherwise noted.

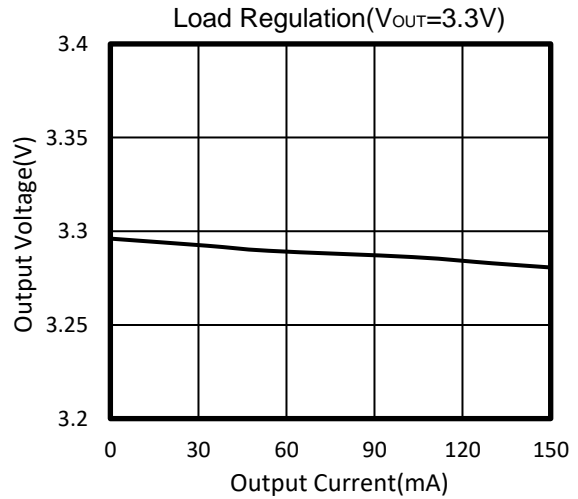
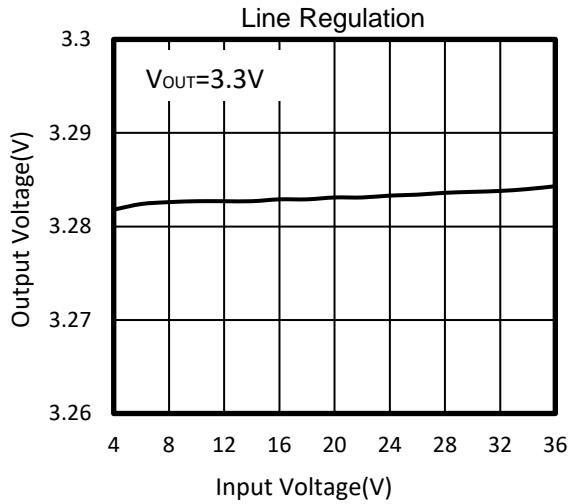
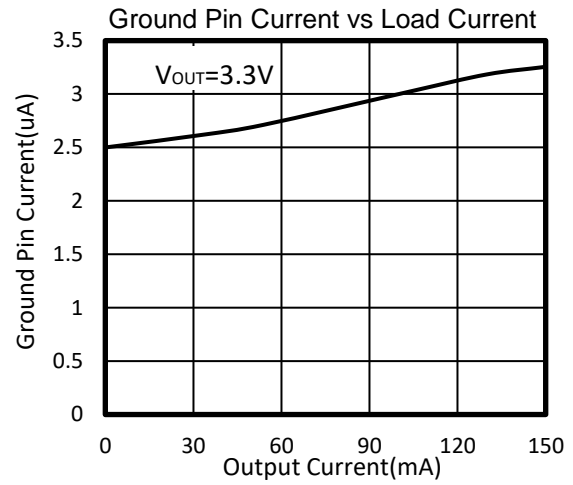
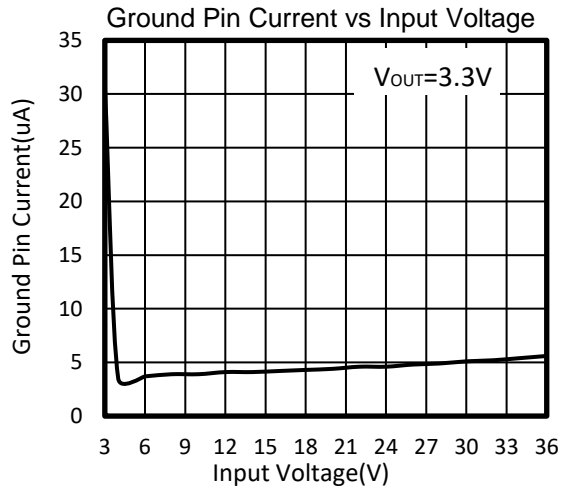

## DETAILED DESCRIPTION

### Overview

The RS3002 low-dropout regulators (LDO) consumes only 2.5  $\mu\text{A}$  of quiescent current at light load and delivers excellent line and load transient performance. These characteristics, combined with low noise and good PSRR with low dropout voltage, make this device ideal for portable consumer applications.

### Functional Block Diagram

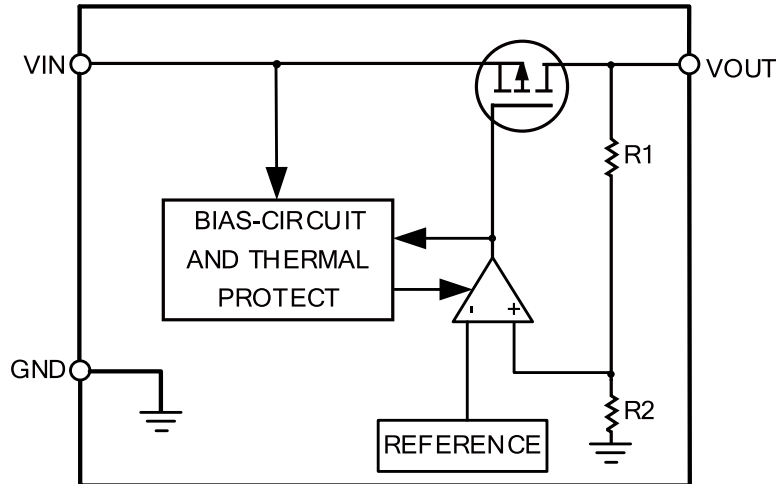

### Thermal Considerations

When the junction temperature is too high, the thermal protection circuitry sends a signal to the control logic that will shut down the IC. The IC will restart when the temperature has sufficiently cooled down. The maximum power dissipation is dependent on the thermal resistance of the case and the circuit board, the temperature difference between the die junction and the ambient air, and the rate of air flow. The GND pin must be connected to the ground plane for proper dissipation.

### Operation with $V_{\text{IN}}$ Lower Than 2.5V

The device normally operates with input voltages above 2.5V. At input voltages below the 2.5V, the device does not operate.

### Operation with $V_{\text{IN}}$ Larger Than 2.5V

When  $V_{\text{IN}}$  is greater than 2.5V, if  $V_{\text{IN}}$  is also higher than the output set value plus the device dropout voltage,  $V_{\text{OUT}}$  is equal to the set value. Otherwise,  $V_{\text{OUT}}$  is equal to  $V_{\text{IN}}$  minus the dropout voltage.

# PACKAGE OUTLINE DIMENSIONS

## SOT23-3

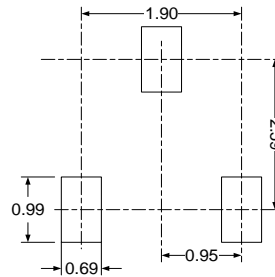
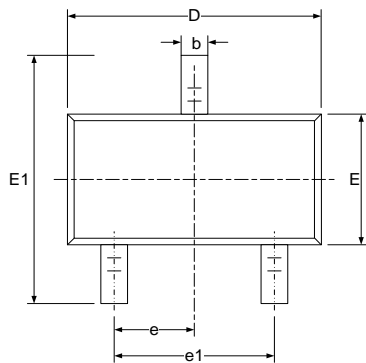
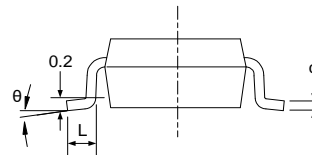
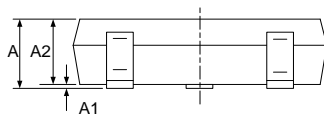

**RECOMMENDED LAND PATTERN (Unit: mm)**

| Symbol   | Dimensions In Millimeters |       | Dimensions In Inches |       |
|----------|---------------------------|-------|----------------------|-------|
|          | Min                       | Max   | Min                  | Max   |
| A        | 1.050                     | 1.250 | 0.041                | 0.049 |
| A1       | 0.000                     | 0.100 | 0.000                | 0.004 |
| A2       | 1.050                     | 1.150 | 0.041                | 0.045 |
| b        | 0.300                     | 0.500 | 0.012                | 0.020 |
| c        | 0.100                     | 0.200 | 0.004                | 0.008 |
| D        | 2.820                     | 3.020 | 0.111                | 0.119 |
| E        | 1.500                     | 1.700 | 0.059                | 0.067 |
| E1       | 2.650                     | 2.950 | 0.104                | 0.116 |
| e        | 0.950(BSC)                |       | 0.037(BSC)           |       |
| e1       | 1.800                     | 2.000 | 0.071                | 0.079 |
| L        | 0.300                     | 0.600 | 0.012                | 0.024 |
| $\theta$ | 0°                        | 8°    | 0°                   | 8°    |

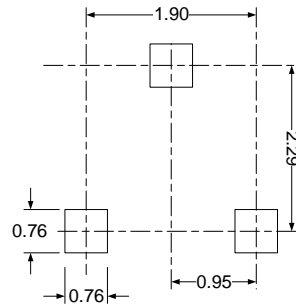
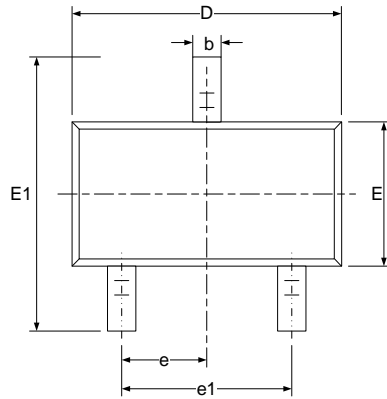
# SOT23

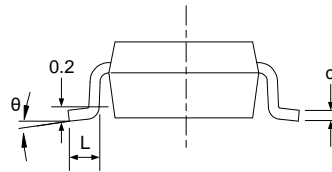
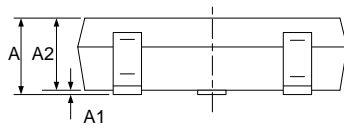

RECOMMENDED LAND PATTERN (Unit: mm)



| Symbol   | Dimensions In Millimeters |       | Dimensions In Inches |       |
|----------|---------------------------|-------|----------------------|-------|
|          | Min                       | Max   | Min                  | Max   |
| A        | 0.900                     | 1.150 | 0.035                | 0.045 |
| A1       | 0.000                     | 0.100 | 0.000                | 0.004 |
| A2       | 0.900                     | 1.050 | 0.035                | 0.041 |
| b        | 0.300                     | 0.500 | 0.012                | 0.020 |
| c        | 0.080                     | 0.150 | 0.003                | 0.006 |
| D        | 2.800                     | 3.000 | 0.110                | 0.118 |
| E        | 1.200                     | 1.400 | 0.047                | 0.055 |
| E1       | 2.250                     | 2.550 | 0.089                | 0.100 |
| e        | 0.950(BSC)                |       | 0.037(BSC)           |       |
| e1       | 1.800                     | 2.000 | 0.071                | 0.079 |
| L        | 0.300                     | 0.500 | 0.012                | 0.020 |
| $\theta$ | 0°                        | 8°    | 0°                   | 8°    |

# SOT23-5

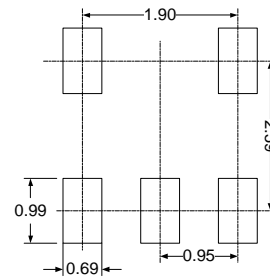
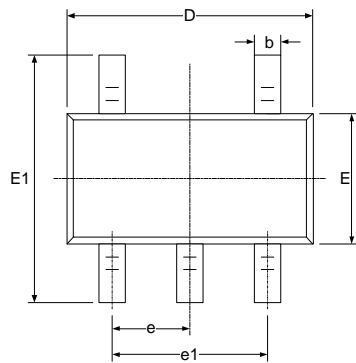

RECOMMENDED LAND PATTERN (Unit: mm)

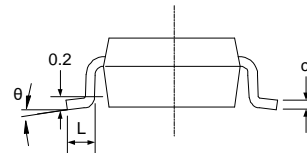
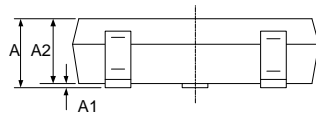

| Symbol | Dimensions In Millimeters |       | Dimensions In Inches |       |
|--------|---------------------------|-------|----------------------|-------|
|        | Min                       | Max   | Min                  | Max   |
| A      | 1.050                     | 1.250 | 0.041                | 0.049 |
| A1     | 0.000                     | 0.100 | 0.000                | 0.004 |
| A2     | 1.050                     | 1.150 | 0.041                | 0.045 |
| b      | 0.300                     | 0.500 | 0.012                | 0.020 |
| c      | 0.100                     | 0.200 | 0.004                | 0.008 |
| D      | 2.820                     | 3.020 | 0.111                | 0.119 |
| E      | 1.500                     | 1.700 | 0.059                | 0.067 |
| E1     | 2.650                     | 2.950 | 0.104                | 0.116 |
| e      | 0.950(BSC)                |       | 0.037(BSC)           |       |
| e1     | 1.800                     | 2.000 | 0.071                | 0.079 |
| L      | 0.300                     | 0.600 | 0.012                | 0.024 |
| θ      | 0°                        | 8°    | 0°                   | 8°    |

# SOT89-3L

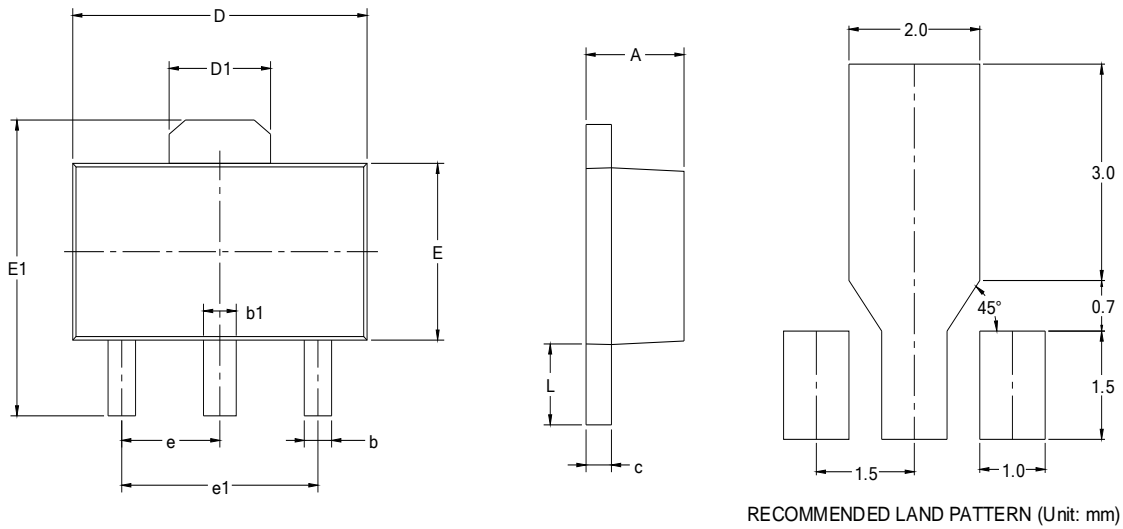

| Symbol | Dimensions In Millimeters |       | Dimensions In Inches |       |
|--------|---------------------------|-------|----------------------|-------|
|        | Min                       | Max   | Min                  | Max   |
| A      | 1.400                     | 1.600 | 0.055                | 0.063 |
| b      | 0.320                     | 0.520 | 0.013                | 0.020 |
| b1     | 0.400                     | 0.580 | 0.016                | 0.023 |
| c      | 0.350                     | 0.440 | 0.014                | 0.017 |
| D      | 4.400                     | 4.600 | 0.173                | 0.181 |
| D1     | 1.550 REF                 |       | 0.061 REF            |       |
| E      | 2.300                     | 2.600 | 0.091                | 0.102 |
| E1     | 3.940                     | 4.250 | 0.155                | 0.167 |
| e      | 1.500 BSC                 |       | 0.060 BSC            |       |
| e1     | 3.000 BSC                 |       | 0.118 BSC            |       |
| L      | 0.900                     | 1.200 | 0.035                | 0.047 |



## X-ON Electronics

Largest Supplier of Electrical and Electronic Components

*Click to view similar products for [Linear Voltage Regulators](#) category:*

*Click to view products by [RUNIC](#) manufacturer:*

Other Similar products are found below :

[LV5684PVD-XH](#) [MCDTSA6-2R](#) [L7815ACV-DG](#) [LV56801P-E](#) [UA7805CKC](#) [714954EB](#) [ZMR500QFTA](#) [BA033LBSG2-TR](#)

[NCV78M05ABDTRKG](#) [LV5680P-E](#) [L79M05T-E](#) [L78LR05D-MA-E](#) [NCV317MBTG](#) [NTE7227](#) [MP2018GZD-33-P](#) [MP2018GZD-5-P](#)

[LV5680NPVC-XH](#) [ZTS6538SE](#) [UA78L09CLP](#) [UA78L09CLPR](#) [CAT6221-PPTD-GT3](#) [MC78M09CDTRK](#) [NCV51190MNTAG](#)

[BL1118CS8TR1833](#) [BL8563CKETR18](#) [BL8077CKETR33](#) [BL9153-33CC3TR](#) [BL9161G-15BADRN](#) [BL9161G-28BADRN](#)

[BRCO7530MMC](#) [CJ7815B-TFN-ARG](#) [LM317C](#) [GM7333K](#) [GM7350K](#) [XC6206P332MR](#) [HT7533](#) [LM7912S/TR](#) [LT1764S/TR](#) [LM7805T](#)

[LM338T](#) [LM1117IMP-3.3/TR](#) [HT1117AM-3.3](#) [HT7550S](#) [AMS1117-3.3](#) [HT7150S](#) [78L12](#) [HT7550](#) [HT7533-1](#) [HXY6206I-2.5](#) [HT7133](#)