

150mA, Ultralow Power Consumption, High Voltage CMOS LDO Regulator

1 FEATURES

- **Ultralow Quiescent Current I_Q :**
2.5 μ A Typical at Light Loads
5 μ A Maximum at Light Loads
- **150mA Nominal Output Current**
- **Low Dropout Voltage**
- **Low Temperature Coefficient**
- **High Input Voltage (up to 36V)**
- **Output Voltage Accuracy:**
 $\pm 2.5\%$ (Max at 25°C)
 $\pm 1.0\%$ (Class A Max at 25°C)
- **Fixed 3.0V、3.3V、3.6V and 5.0V
Output Voltage**
- **Operating Temperature Range:**
-40°C to +85°C
- **Micro SIZE PACKAGES: SOT23-3、SOT23、
SOT89-3L、SOT89-3L(L-Type) and SOT223**

2 APPLICATIONS

- **Audio/Video Equipment**
- **Communication Equipment**
- **Battery-Powered Equipment**
- **Automotive Head Unit**
- **Laptop, Palmtops, Notebook Computers**

3 DESCRIPTIONS

The RS3002 series is a set of low power high voltage regulators implemented in CMOS technology. It can operate from 2.5V to 36V. Which can provide 150mA output current. The device allows input voltage as high as 36V.

The RS3002 series is available in several fixed output voltages. CMOS technology ensures low dropout voltage and ultralow quiescent current.

The RS3002 is available in Green SOT23-3, SOT23, SOT89-3L and SOT223 packages. It operates over an ambient temperature range of -40°C to +85°C.

Device Information (1)

PART NUMBER	PACKAGE	BODY SIZE (NOM)
RS3002	SOT23-3(3)	1.60mm×2.92mm
	SOT23(3)	1.30mm×2.92mm
	SOT23-5(5)	1.60mm×2.92mm
	SOT89-3L(3)	2.45mm×4.50mm
	TO-92(3)	4.60mm×4.60mm
	SOT223(3)	3.50mm×7.00mm

(1) For all available packages, see the orderable addendum at the end of the data sheet.

4 Typical Application Schematic

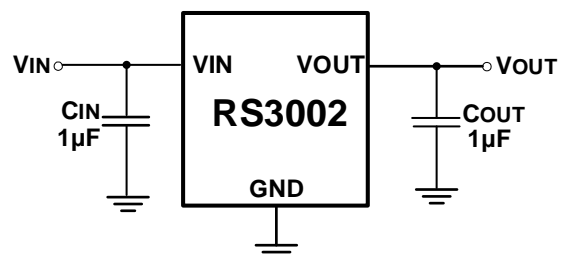

Table of Contents

1 FEATURES	1
2 APPLICATIONS	1
3 DESCRIPTIONS	1
4 Typical Application Schematic	1
5 Revision History	3
6 Pin Configuration and Functions (Top View)	4
7 PACKAGE/ORDERING INFORMATION ⁽¹⁾	6
8 Specifications	7
8.1 Absolute Maximum Ratings	7
8.2 ESD Ratings	7
8.3 Recommended Operating Conditions	7
8.4 Thermal Information	8
8.5 ELECTRICAL CHARACTERISTICS	9
8.6 TYPICAL CHARACTERISTICS	11
9 DETAILED DESCRIPTION	13
9.1 Overview	13
9.2 Thermal Considerations	13
9.3 Operation with V_{IN} Lower Than 2.5V	13
9.4 Operation with V_{IN} Larger Than 2.5V	13
10 PACKAGE OUTLINE DIMENSIONS	14
11 TAPE AND REEL INFORMATION	20

5 Revision History

Note: Page numbers for previous revisions may differ from page numbers in the current version.

VERSION	Change Date	Change Item
A.1	2019/04/13	Initial version completed
A.2	2019/06/08	1) Added 4.36V output voltage 2) Added TO-92 package
A.3	2019/11/01	Added SOT23-5 package
A.4	2020/09/02	Increase the thermal protection temperature to 150°C
B.1	2021/12/10	1) Modify PACKAGE/ORDERING INFORMATION on Page 4 @ A.4 Version. 2) Change SOT23-5, SOT23-3 and SOT89-3L (L-Type) Thermal Information on Page 5 @A.4 Version. 3) Added SOT223 package
B.2	2022/09/29	Update PACKAGE MARKING on Page 5@RevB.1

6 Pin Configuration and Functions (Top View)

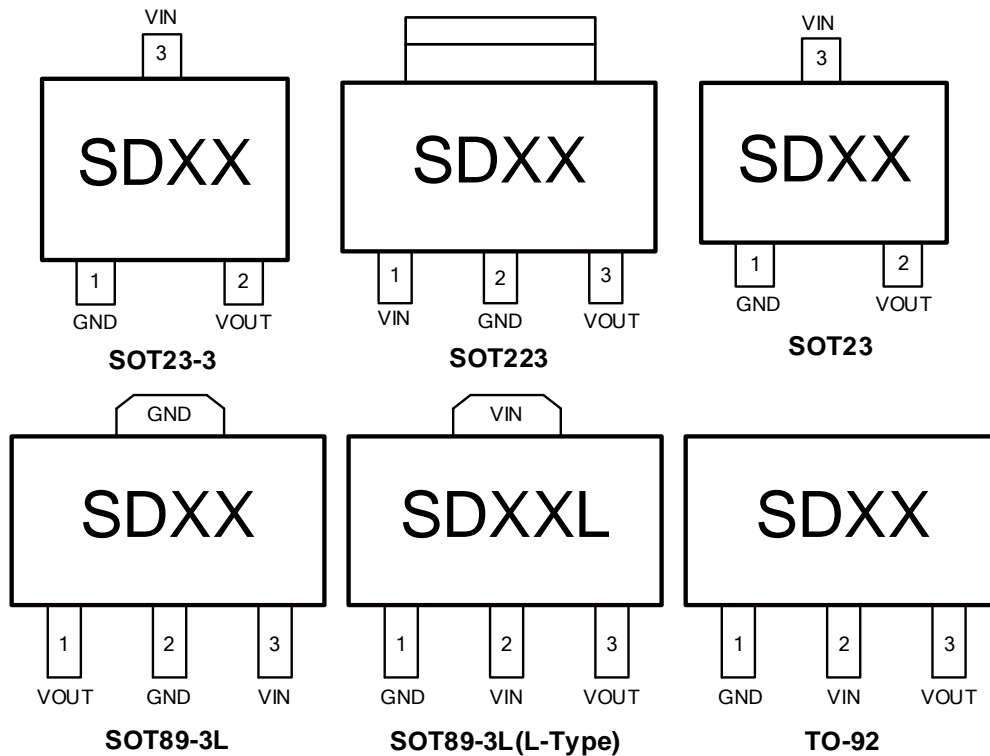

NOTE: XX indicate Output Voltage, xx indicate Date Code
For example: SD33(V_{out}=3.3V)

PIN DESCRIPTION

NAME	PIN					FUNCTION
	SOT23-3	SOT23	SOT89-3L	SOT89-3L (L-Type)/TO-92	SOT223	
GND	1	1	2	1	2	Ground.
VOUT	2	2	1	3	3	Regulator Output. Recommended output capacitor range: 1μF to 10μF.
VIN	3	3	3	2	1	Regulator Input. Up to 36V input voltage. At least 1μF supply bypass capacitor is recommended.

Pin Configuration and Functions (Top View)

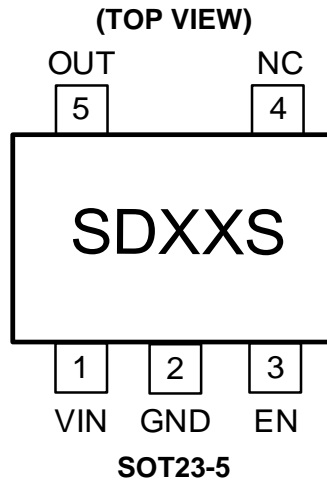

SOT23-5		I/O ⁽¹⁾	DESCRIPTION
NUMBER	NAME		
1	VIN	I	Regulator Input. Up to 36V input voltage. At least 1 μ F supply bypass capacitor is recommended.
2	GND	G	Ground.
3	EN	I	Enable pin. Drive EN greater than V _{EN(H)} to turn on the regulator. Drive EN less than V _{EN(L)} to put the LDO into shutdown mode.
4	NC	-	Not connect.
5	OUT	O	Regulator Output. Recommended output capacitor range: 1 μ F to 10 μ F.

(1) I = Input, O = Output, G=Ground.

7 PACKAGE/ORDERING INFORMATION ⁽¹⁾

PRODUCT	ORDERING NUMBER	V _{OUT} (V)	V _{OUT} Accuracy	PACKAGE LEAD	PACKAGE MARKING ⁽²⁾	PACKAGE OPTION
RS3002-3.0	RS3002-3.0YF3	3.0	±2.5%	SOT23-3	SD30	Tape and Reel,3000
	RS3002-3.0SYF5	3.0	±2.5%	SOT23-5	SD30S	Tape and Reel,3000
	RS3002-3.0YSF3	3.0	±2.5%	SOT23	SD30	Tape and Reel,3000
	RS3002-3.0YE3	3.0	±2.5%	SOT89-3L	SD30	Tape and Reel,1000
	RS3002-3.0YE3L	3.0	±2.5%	SOT89-3L (L-Type)	SD30L	Tape and Reel,1000
RS3002-3.3	RS3002-3.3YF3	3.3	±2.5%	SOT23-3	SD33	Tape and Reel,3000
	RS3002-3.3SYF5	3.3	±2.5%	SOT23-5	SD33S	Tape and Reel,3000
	RS3002-3.3YSF3	3.3	±2.5%	SOT23	SD33	Tape and Reel,3000
	RS3002-3.3YD3	3.3	±2.5%	SOT223	SD33	Tape and Reel,2500
	RS3002-3.3YE3	3.3	±2.5%	SOT89-3L	SD33	Tape and Reel,1000
	RS3002-3.3YE3L	3.3	±2.5%	SOT89-3L (L-Type)	SD33L	Tape and Reel,1000
RS3002-3.6	RS3002-3.6YF3	3.6	±2.5%	SOT23-3	SD36	Tape and Reel,3000
	RS3002-3.6SYF5	3.6	±2.5%	SOT23-5	SD36S	Tape and Reel,3000
	RS3002-3.6YSF3	3.6	±2.5%	SOT23	SD36	Tape and Reel,3000
	RS3002-3.6YE3	3.6	±2.5%	SOT89-3L	SD36	Tape and Reel,1000
	RS3002-3.6YE3L	3.6	±2.5%	SOT89-3L (L-Type)	SD36L	Tape and Reel,1000
RS3002-5.0	RS3002-5.0YF3	5.0	±2.5%	SOT23-3	SD50	Tape and Reel,3000
	RS3002-5.0SYF5	5.0	±2.5%	SOT23-5	SD50S	Tape and Reel,3000
	RS3002-5.0YSF3	5.0	±2.5%	SOT23	SD50	Tape and Reel,3000
	RS3002-5.0YE3	5.0	±2.5%	SOT89-3L	SD50	Tape and Reel,1000
	RS3002-5.0YE3L	5.0	±2.5%	SOT89-3L (L-Type)	SD50L	Tape and Reel,1000
	RS3002-5.0YD3	5.0	±2.5%	SOT223	SD50	Tape and Reel,2500
	RS3002-5.0YT3	5.0	±2.5%	TO-92	SD50	Tape and Reel,2000

NOTE:

- (1) This information is the most current data available for the designated devices. This data is subject to change without notice and revision of this document. For browser-based versions of this data sheet, refer to the right-hand navigation.
- (2) There may be additional marking, which relates to the lot trace code information (data code and vendor code), the logo or the environmental category on the device.

8 Specifications

8.1 Absolute Maximum Ratings

over operating free-air temperature range (unless otherwise noted) ⁽¹⁾ ⁽²⁾

		MIN	MAX	UNIT
V _{IN}	Input voltage	-0.3	45	V
V _{EN}	Enable input voltage	-0.3	V _{IN}	V
T _J	Junction temperature ⁽³⁾	-40	150	°C
P _D	Continuous power dissipation ⁽⁴⁾	Internally Limited		W
T _{stg}	Storage temperature	-65	150	°C

(1) Stresses beyond those listed under *Absolute Maximum Ratings* may cause permanent damage to the device. These are stress ratings only, and functional operation of the device at these or any other conditions beyond those indicated under *Recommended Operating Conditions* is not implied. Exposure to absolute-maximum-rated conditions for extended periods may affect device reliability.

(2) All voltages are with respect to the GND pin.

(3) The maximum power dissipation is a function of T_{J(MAX)}, R_{θJA}, and T_A. The maximum allowable power dissipation at any ambient temperature is P_D = (T_{J(MAX)} - T_A) / R_{θJA}. All numbers apply for packages soldered directly onto a PCB.

(4) Internal thermal shutdown circuitry protects the device from permanent damage.

8.2 ESD Ratings

The following ESD information is provided for handling of ESD-sensitive devices in an ESD protected area only.

		VALUE	UNIT
V _(ESD) Electrostatic discharge	Human-body model (HBM), per ANSI/ESDA/JEDEC JS-001 ⁽¹⁾	±1000	V
	Machine model (MM)	±100	V

(1) JEDEC document JEP155 states that 500 V HBM allows safe manufacturing with a standard ESD control process.



ESD SENSITIVITY CAUTION

ESD damage can range from subtle performance degradation to complete device failure. Precision integrated circuits may be more susceptible to damage because very small parametric changes could cause the device not to meet its published specifications.

8.3 Recommended Operating Conditions

over operating free-air temperature range (unless otherwise noted) ⁽¹⁾

		MIN	MAX	UNIT
V _{IN}	Input supply voltage	2.5	36	V
V _{EN}	Enable voltage	0	36	V
T _A	Operating temperature	-40	+85	°C

(1) All voltages are with respect to the GND pin.

8.4 Thermal Information

THERMAL METRIC ⁽¹⁾		RS3002							UNIT
		SOT23	SOT23-3	SOT23-5	SOT89-3L	SOT89-3L (L-Type)	SOT22 3	TO-92	
		3 PINS	3 PINS	5 PINS	3 PINS	3 PINS	3 PINS	3 PINS	
R _{θJA}	Junction-to-ambient thermal resistance	185.6	312.5	250	75	208.3	84.5	143.6	°C/W
R _{θJC(top)}	Junction-to-case (top) thermal resistance	104.3	134.3	84.3	88.1	88.5	45.5	74.4	°C/W
R _{θJB}	Junction-to-board thermal resistance	54.5	84.5	39.5	9.6	39.6	11.0	—	°C/W
ψ _{JT}	Junction-to-top characterization parameter	31.0	4.8	2.86	6.2	26.5	4.85	24.2	°C/W
ψ _{JB}	Junction-to-board characterization parameter	54.5	81.5	58.7	9.7	49.7	11.0	120.9	°C/W
R _{θJC(bot)}	Junction-to-case (bottom) thermal resistance	N/A	N/A	N/A	7.7	77.7	11.0	—	°C/W
P _D	Power Dissipation	0.7	0.4	0.5	1.7	0.6	1.5	0.87	W

(1) Thermal resistance varies with operating conditions.

8.5 ELECTRICAL CHARACTERISTICS

($V_{IN} = V_{OUT} + 2V$, $C_{IN} = C_{OUT} = 1\mu F$, $V_{OUT} = 3.3V$, Full = $-40^{\circ}C$ to $+85^{\circ}C$, typical values are at $T_A = +25^{\circ}C$, unless otherwise noted.)

PARAMETER	SYMBOL	CONDITIONS	TEMP	MIN	TYP	MAX	UNITS
Input Voltage	V_{IN}	$V_{OUT} = 3.3V$	$+25^{\circ}C$	2.5 ⁽¹⁾		36	V
Output Voltage Accuracy		$I_{OUT} = 1mA$	$+25^{\circ}C$	-2.5	0	2.5	%
		$I_{OUT} = 1mA$, Class A	$+25^{\circ}C$	-1.0	0	1.0	%
Ground Pin Current		No load	$+25^{\circ}C$	$V_{IN} = V_{OUT} + 2V$	2.5	5	μA
				$V_{IN} = 36V$	5.0	8	
		$I_{OUT} = 50mA$		2.5			
Maximum Output Current ⁽²⁾			$+25^{\circ}C$	150			mA
Dropout Voltage ⁽³⁾	V_{DROP}	$I_{OUT} = 150mA$	$+25^{\circ}C$		1200	1800	mV
Line Regulation	$\frac{\Delta V_{OUT}}{\Delta V_{IN} \times V_{OUT}}$	$V_{IN} = V_{OUT} + 2V$ to $36V$, $I_{OUT} = 1mA$	$+25^{\circ}C$		0.001	0.012	%/V
Load Regulation	ΔV_{OUT}	$V_{IN} = V_{OUT} + 2V$, $I_{OUT} = 1mA$ to $150mA$	$+25^{\circ}C$		11	20	mV
Power Supply Rejection Ratio	PSRR	$V_{OUT} = 3.3V$, $I_{OUT} = 10mA$	$+25^{\circ}C$	$f = 217Hz$	57		dB
				$f = 1KHz$	54		
Output Voltage Temperature Coefficient ⁽⁴⁾	$\frac{\Delta V_{OUT}}{\Delta T_A \times V_{OUT}}$	$I_{OUT} = 1mA$	FULL		70		ppm/ $^{\circ}C$
THERMAL PROTECTION							
Thermal Shutdown Temperature	T_{SHDN}				150		$^{\circ}C$
SHUTDOWN							
EN Voltage Range	V_{EN}		FULL	-0.3		$V_{IN} + 0.3$	V
EN Input Threshold	V_{IH}	$V_{IN} = V_{OUT} + 2V$ to $36V$	FULL	1.1			V
	V_{IL}	$V_{IN} = V_{OUT} + 2V$ to $36V$	FULL			0.4	
EN Input Bias Current	I_{BH}	EN=36V	$+25^{\circ}C$		0.01	1	μA
	I_{BL}	EN=0V	FULL		0.01	1	
Shutdown Supply Current	$I_{Q(SHDN)}$	EN=0V	FULL		1.0	2	μA
Start-Up Time ⁽⁵⁾	t_{STR}	$C_{OUT} = 1\mu F$, No Load	$+25^{\circ}C$		230		μs

NOTES:

(1) $V_{IN} = V_{OUT (NOMINAL)}$ or 2.5V, whichever is greater.

(2) Maximum output current is affected by the PCB layout, size of metal trace, the thermal conduction path between metal layers, ambient temperature and the other environment factors of system. Attention should be paid to the dropout voltage when $V_{IN} < V_{OUT} + V_{DROP}$.

(3) The dropout voltage is defined as $V_{IN} - V_{OUT}$, when V_{OUT} is 100mV below the value of V_{OUT} for $V_{IN} = V_{OUT (NOMINAL)} + 2V$.

(4) Output voltage temperature coefficient is defined as the worst-case voltage change divided by the total temperature range.

(5) Time needed for V_{OUT} to reach 90% of final value.

ELECTRICAL CHARACTERISTICS

($V_{IN} = V_{OUT} + 2V$, $C_{IN} = C_{OUT} = 1\mu F$, $V_{OUT} = 5.0V$, Full = $-40^{\circ}C$ to $+85^{\circ}C$, typical values are at $T_A = +25^{\circ}C$, unless otherwise noted.)

PARAMETER	SYMBOL	CONDITIONS	TEMP	MIN	TYP	MAX	UNITS	
Input Voltage	V_{IN}	$V_{OUT} = 5.0V$	$+25^{\circ}C$	2.5 ⁽¹⁾		36	V	
Output Voltage Accuracy		$I_{OUT} = 1mA$	$+25^{\circ}C$	-2.5	0	2.5	%	
		$I_{OUT} = 1mA$, Class A	$+25^{\circ}C$	-1.0	0	1.0	%	
Ground Pin Current		No load	$V_{IN} = V_{OUT} + 2V$ $V_{IN} = 36V$	$+25^{\circ}C$		2.5	5	μA
						5.0	8	
		$I_{OUT} = 50mA$			2.5			
Maximum Output Current ⁽²⁾			$+25^{\circ}C$	150			mA	
Dropout Voltage ⁽³⁾	V_{DROP}	$I_{OUT} = 150mA$	$+25^{\circ}C$		1000	1600	mV	
Line Regulation	$\frac{\Delta V_{OUT}}{\Delta V_{IN} \times V_{OUT}}$	$V_{IN} = V_{OUT} + 2V$ to 36V, $I_{OUT} = 1mA$	$+25^{\circ}C$		0.001	0.012	%/V	
Load Regulation	ΔV_{OUT}	$V_{IN} = V_{OUT} + 2V$, $I_{OUT} = 1mA$ to 150mA	$+25^{\circ}C$		11	20	mV	
Power Supply Rejection Ratio	PSRR	$V_{OUT} = 5.0V$, $I_{OUT} = 10mA$	$f = 217Hz$ $f = 1KHz$	$+25^{\circ}C$		57		dB
						54		
Output Voltage Temperature Coefficient ⁽⁴⁾	$\frac{\Delta V_{OUT}}{\Delta T_A \times V_{OUT}}$	$I_{OUT} = 1mA$	FULL		70		ppm/ $^{\circ}C$	
THERMAL PROTECTION								
Thermal Shutdown Temperature	T_{SHDN}				150		$^{\circ}C$	
SHUTDOWN								
EN Voltage Range	V_{EN}		FULL	-0.3		$V_{IN} + 0.3$	V	
EN Input Threshold	V_{IH}	$V_{IN} = V_{OUT} + 2V$ to 36V	FULL	1.1			V	
	V_{IL}	$V_{IN} = V_{OUT} + 2V$ to 36V	FULL			0.4		
EN Input Bias Current	I_{BH}	EN=36V	$+25^{\circ}C$		0.01	1	μA	
	I_{BL}	EN=0V	FULL		0.01	1		
Shutdown Supply Current	$I_{Q(SHDN)}$	EN=0V	FULL		1.0	2	μA	
Start-Up Time ⁽⁵⁾	t_{STR}	$C_{OUT} = 1\mu F$, No Load	$+25^{\circ}C$		230		μs	

NOTES:

- (1) $V_{IN} = V_{OUT (NOMINAL)}$ or 2.5V, whichever is greater.
- (2) Maximum output current is affected by the PCB layout, size of metal trace, the thermal conduction path between metal layers, ambient temperature and the other environment factors of system. Attention should be paid to the dropout voltage when $V_{IN} < V_{OUT} + V_{DROP}$.
- (3) The dropout voltage is defined as $V_{IN} - V_{OUT}$, when V_{OUT} is 100mV below the value of V_{OUT} for $V_{IN} = V_{OUT (NOMINAL)} + 2V$.
- (4) Output voltage temperature coefficient is defined as the worst-case voltage change divided by the total temperature range.
- (5) Time needed for V_{OUT} to reach 90% of final value.

8.6 TYPICAL CHARACTERISTICS

NOTE: The graphs and tables provided following this note are a statistical summary based on a limited number of samples and are provided for informational purposes only.

$V_{IN} = 5.3V$, $V_{OUT} = 3.3V$, $C_{IN} = C_{OUT} = 1\mu F$, $T_A = 25^\circ C$ unless otherwise noted.

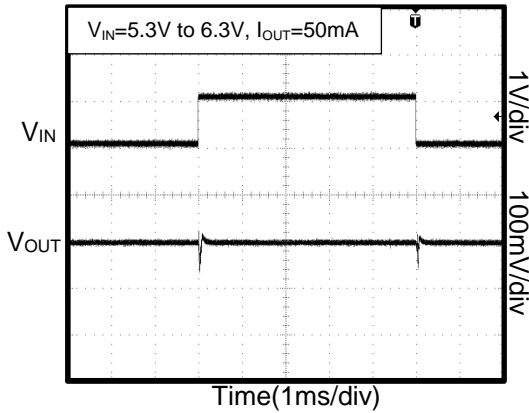

Figure 1. Line-Transient Response

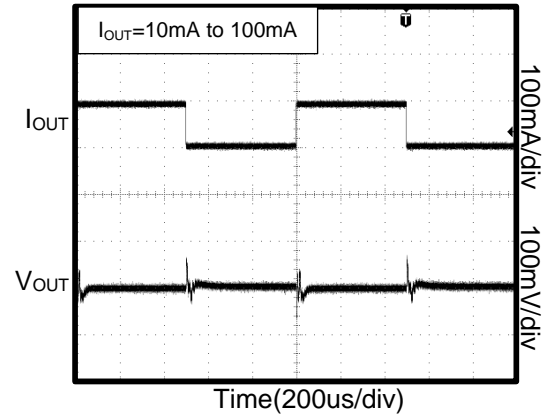

Figure 2. Load-Transient Response

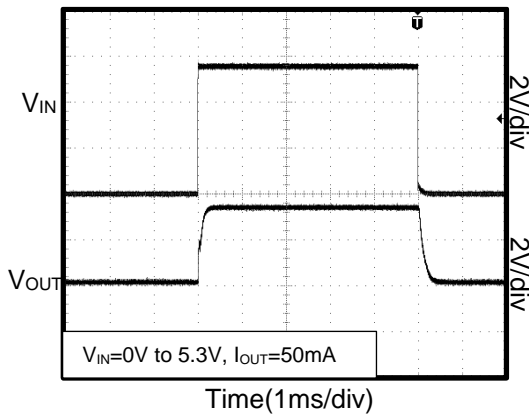

Figure 3. Power-Up/Power-Down Output Waveform

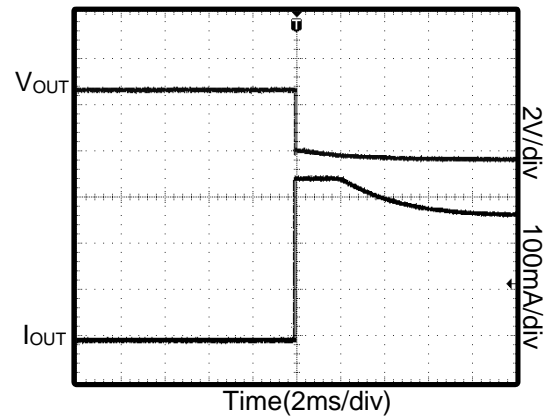

Figure 4. Output Short Waveform

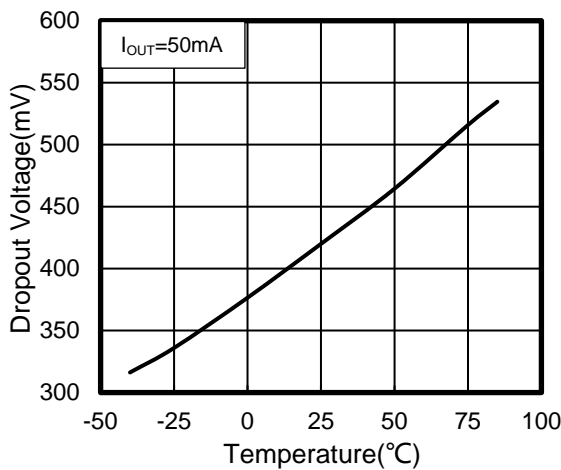

Figure 5. Dropout Voltage vs Temperature

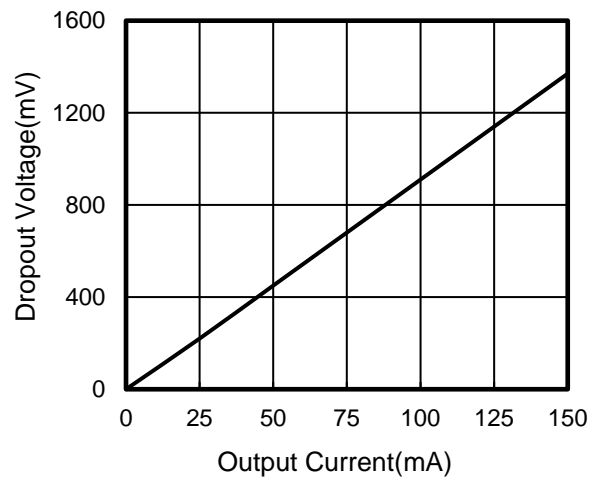

Figure 6. Dropout Voltage vs Output Current

TYPICAL CHARACTERISTICS

NOTE: The graphs and tables provided following this note are a statistical summary based on a limited number of samples and are provided for informational purposes only.

$V_{IN} = 5.3V$, $V_{OUT} = 3.3V$, $C_{IN} = C_{OUT} = 1\mu F$, $T_A = 25^\circ C$ unless otherwise noted.

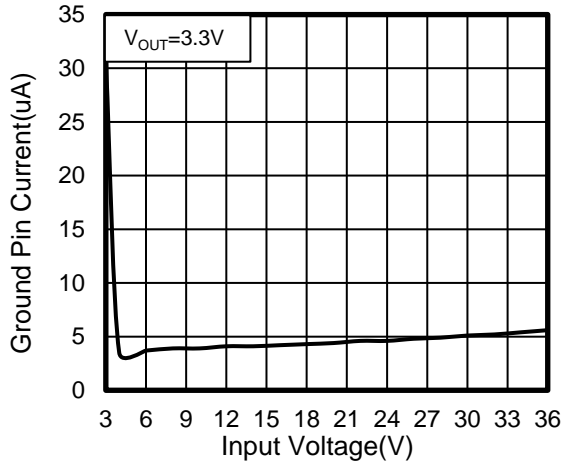

Figure 7. Ground Pin Current vs Input Voltage

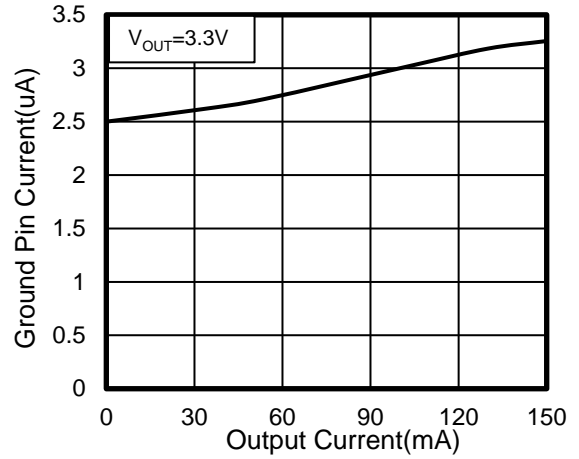

Figure 8. Ground Pin Current vs Load Current

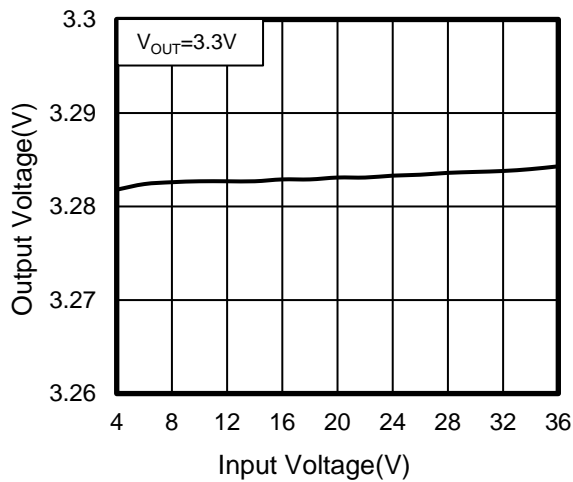

Figure 9. Line Regulation

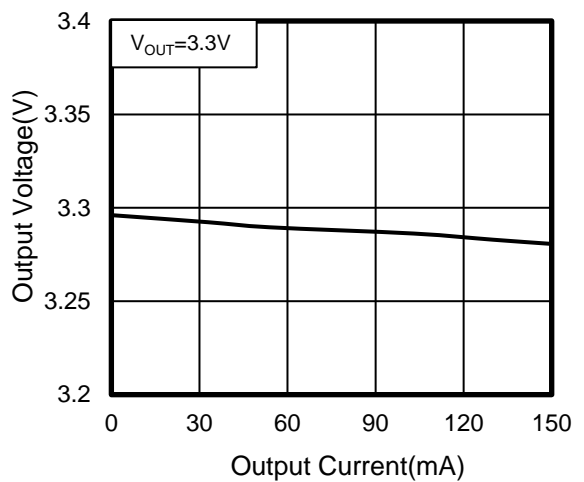
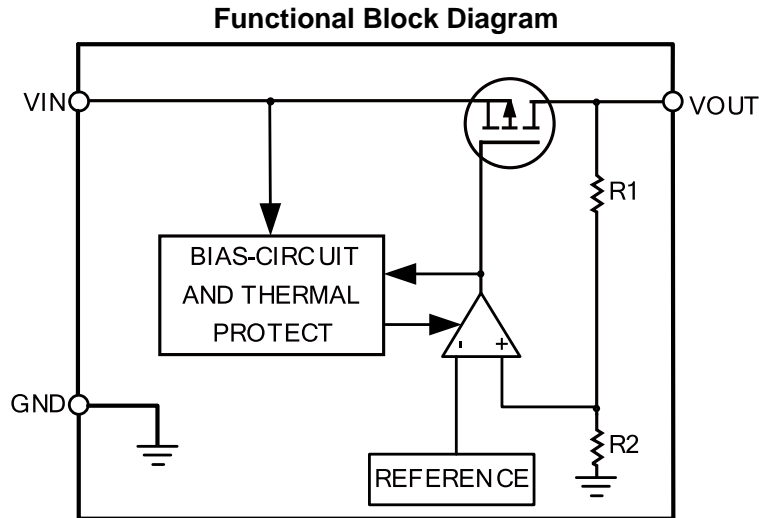

Figure 10. Load Regulation

9 DETAILED DESCRIPTION

9.1 Overview

The RS3002 low-dropout regulators (LDO) consumes only 2.5 μA of quiescent current at light load and delivers excellent line and load transient performance. These characteristics, combined with low noise and good PSRR with low dropout voltage, make this device ideal for portable consumer applications.



9.2 Thermal Considerations

When the junction temperature is too high, the thermal protection circuitry sends a signal to the control logic that will shut down the IC. The IC will restart when the temperature has sufficiently cooled down. The maximum power dissipation is dependent on the thermal resistance of the case and the circuit board, the temperature difference between the die junction and the ambient air, and the rate of air flow. The GND pin must be connected to the ground plane for proper dissipation.

9.3 Operation with V_{IN} Lower Than 2.5V

The device normally operates with input voltages above 2.5V. At input voltages below the 2.5V, the device does not operate.

9.4 Operation with V_{IN} Larger Than 2.5V

When V_{IN} is greater than 2.5V, if V_{IN} is also higher than the output set value plus the device dropout voltage, V_{OUT} is equal to the set value. Otherwise, V_{OUT} is equal to V_{IN} minus the dropout voltage.

10 PACKAGE OUTLINE DIMENSIONS

SOT23-3

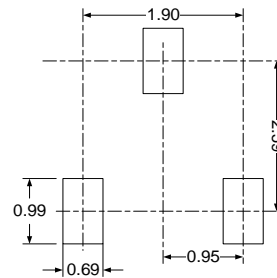
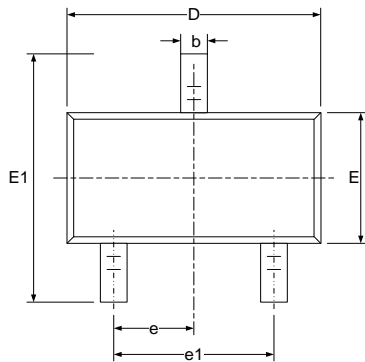

RECOMMENDED LAND PATTERN (Unit: mm)

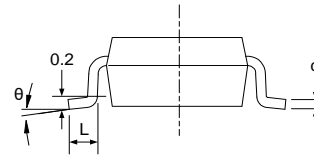
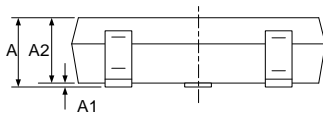

Symbol	Dimensions In Millimeters		Dimensions In Inches	
	Min	Max	Min	Max
A	1.050	1.250	0.041	0.049
A1	0.000	0.100	0.000	0.004
A2	1.050	1.150	0.041	0.045
b	0.300	0.500	0.012	0.020
c	0.100	0.200	0.004	0.008
D	2.820	3.020	0.111	0.119
E	1.500	1.700	0.059	0.067
E1	2.650	2.950	0.104	0.116
e	0.950(BSC)		0.037(BSC)	
e1	1.800	2.000	0.071	0.079
L	0.300	0.600	0.012	0.024
θ	0°	8°	0°	8°

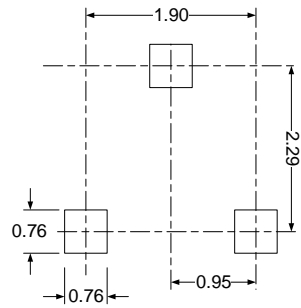
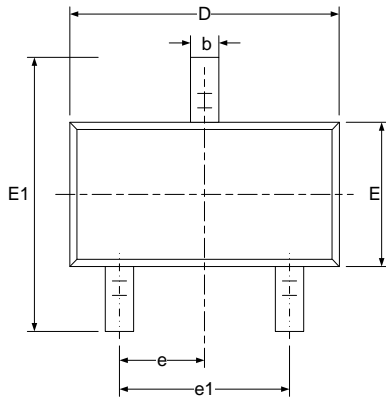
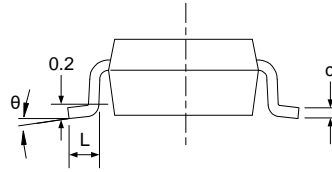
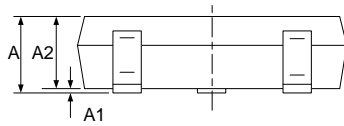
SOT23

RECOMMENDED LAND PATTERN (Unit: mm)

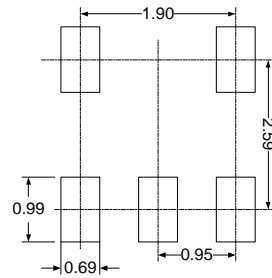
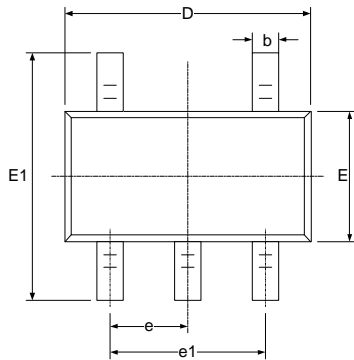
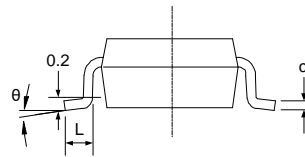
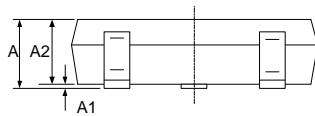
Symbol	Dimensions In Millimeters		Dimensions In Inches	
	Min	Max	Min	Max
A	0.900	1.150	0.035	0.045
A1	0.000	0.100	0.000	0.004
A2	0.900	1.050	0.035	0.041
b	0.300	0.500	0.012	0.020
c	0.080	0.150	0.003	0.006
D	2.800	3.000	0.110	0.118
E	1.200	1.400	0.047	0.055
E1	2.250	2.550	0.089	0.100
e	0.950(BSC)		0.037(BSC)	
e1	1.800	2.000	0.071	0.079
L	0.300	0.500	0.012	0.020
θ	0°	8°	0°	8°

SOT23-5

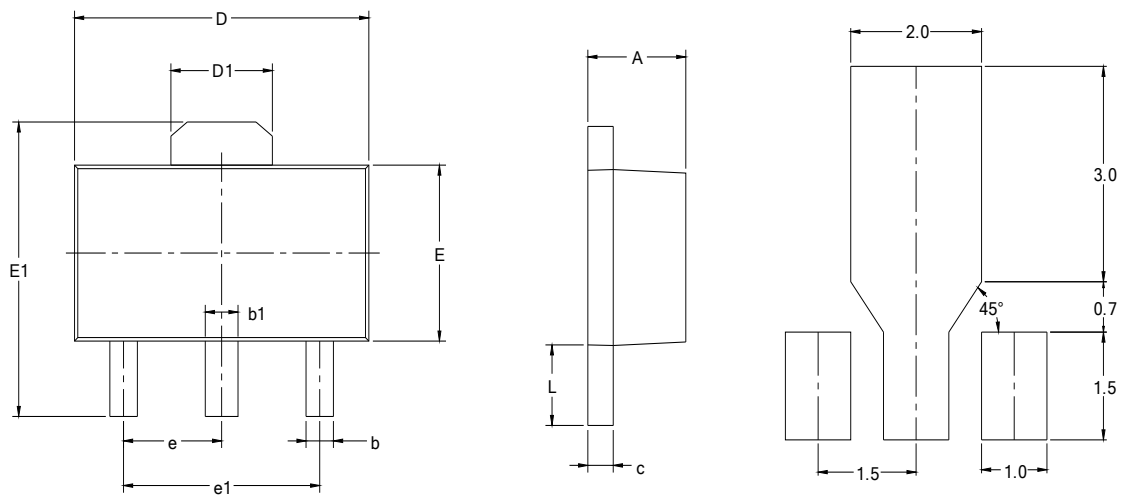
RECOMMENDED LAND PATTERN (Unit: mm)

Symbol	Dimensions In Millimeters		Dimensions In Inches	
	Min	Max	Min	Max
A	1.050	1.250	0.041	0.049
A1	0.000	0.100	0.000	0.004
A2	1.050	1.150	0.041	0.045
b	0.300	0.500	0.012	0.020
c	0.100	0.200	0.004	0.008
D	2.820	3.020	0.111	0.119
E	1.500	1.700	0.059	0.067
E1	2.650	2.950	0.104	0.116
e	0.950(BSC)		0.037(BSC)	
e1	1.800	2.000	0.071	0.079
L	0.300	0.600	0.012	0.024
θ	0°	8°	0°	8°

SOT89-3L

RECOMMENDED LAND PATTERN (Unit: mm)

Symbol	Dimensions In Millimeters		Dimensions In Inches	
	Min	Max	Min	Max
A	1.400	1.600	0.055	0.063
b	0.320	0.520	0.013	0.020
b1	0.400	0.580	0.016	0.023
c	0.350	0.440	0.014	0.017
D	4.400	4.600	0.173	0.181
D1	1.550 REF		0.061 REF	
E	2.300	2.600	0.091	0.102
E1	3.940	4.250	0.155	0.167
e	1.500 BSC		0.060 BSC	
e1	3.000 BSC		0.118 BSC	
L	0.900	1.200	0.035	0.047

TO-92

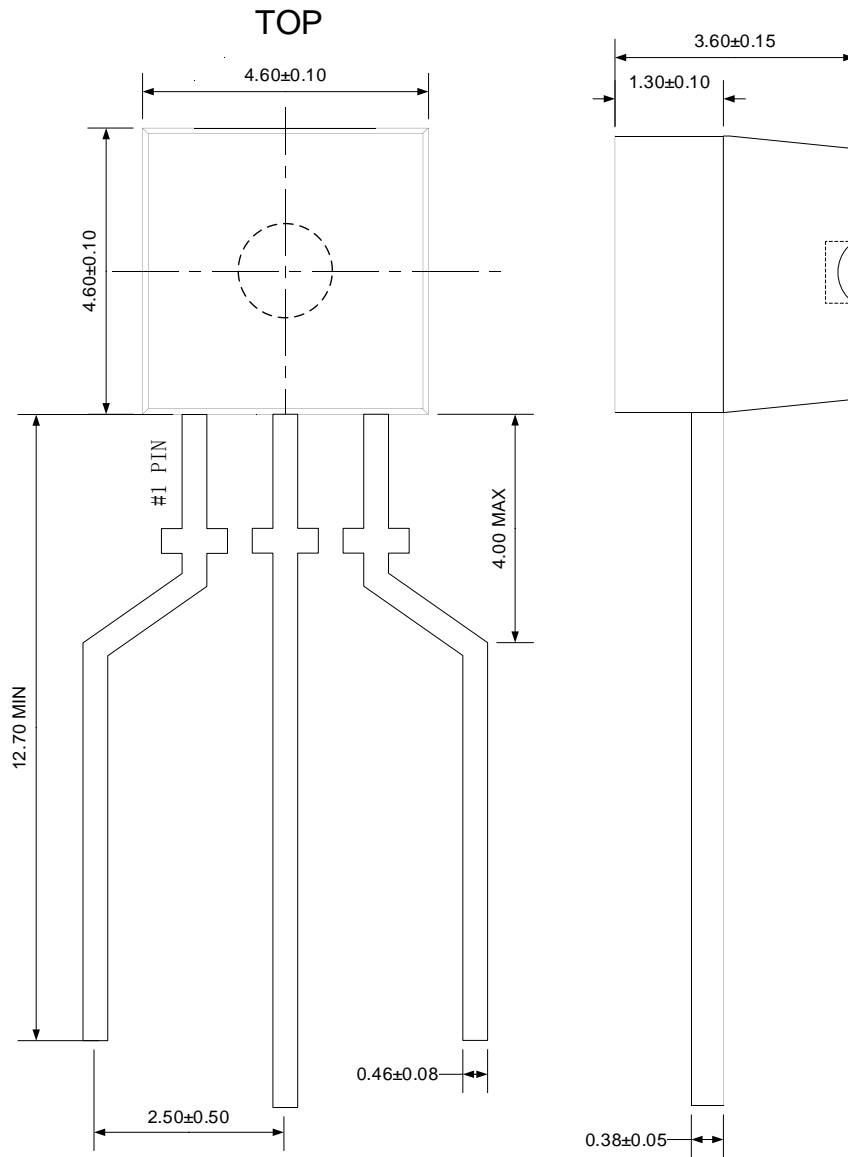

RECOMMENDED LAND PATTERN (Unit: mm)

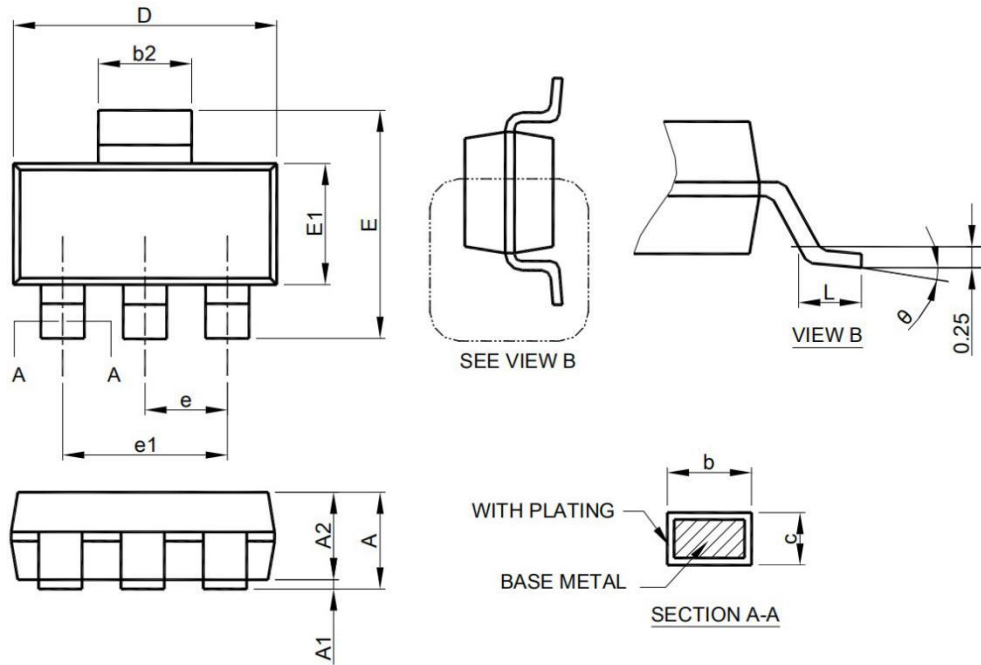
SOT223

Symbol	Dimensions In Millimeters		Dimensions In Inches	
	Min	Max	Min	Max
A	-	1.800	-	0.071
A1	0.02	0.10	0.001	0.004
A2	1.55	1.65	0.061	0.065
b	0.66	0.84	0.026	0.033
b2	2.90	3.10	0.114	0.122
c	0.23	0.33	0.009	0.013
D	6.30	6.70	0.248	0.263
E	6.70	7.30	0.263	0.287
E1	3.30	3.70	0.130	0.145
e	2.30 BSC		0.090 BSC	
e1	4.60 BSC		0.181 BSC	
L	0.90	-	0.035	-

NOTE:

- A. All linear dimension is in millimeters.
- B. This drawing is subject to change without notice.
- C. Body dimensions do not include mold flash or protrusion. Mold flash and protrusion shall not exceed 0.15 per side.
- D. BSC: Basic Dimension. Theoretically exact value shown without tolerances.
- E. REF: Reference Dimension, usually without tolerance, for information purposes only.

11 TAPE AND REEL INFORMATION

REEL DIMENSIONS

TAPE DIMENSION

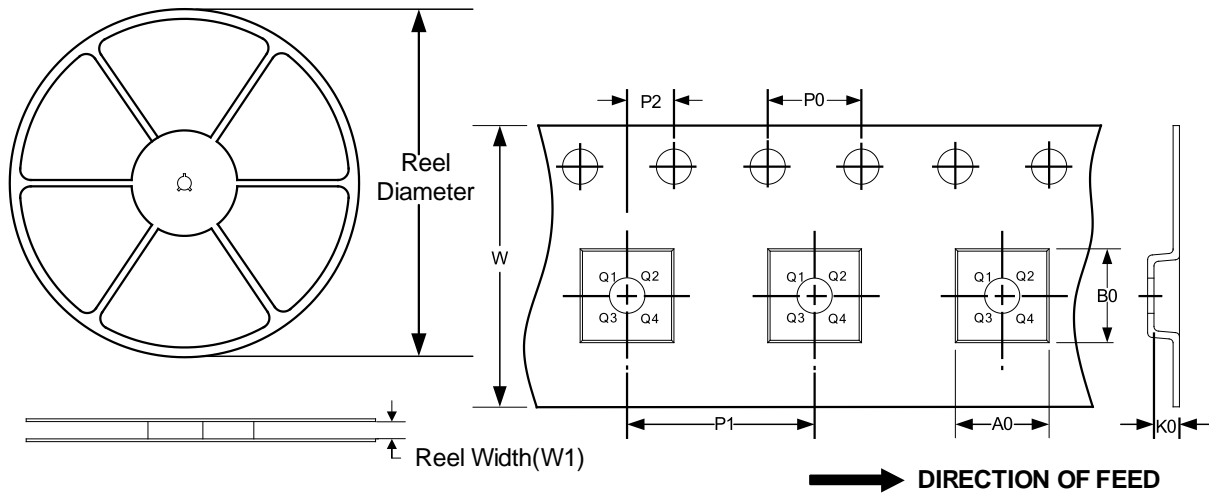

NOTE: The picture is only for reference. Please make the object as the standard.

KEY PARAMETER LIST OF TAPE AND REEL

Package Type	Reel Diameter	Reel Width(mm)	A0 (mm)	B0 (mm)	K0 (mm)	P0 (mm)	P1 (mm)	P2 (mm)	W (mm)	Pin1 Quadrant
SOT23-3	7"	9.0	3.20	3.30	1.30	4.0	4.0	2.0	8.0	Q3
SOT23	7"	9.5	3.15	2.77	1.22	4.0	4.0	2.0	8.0	Q3
SOT23-5	7"	9.5	3.20	3.20	1.40	4.0	4.0	2.0	8.0	Q3
SOT89-3L	7"	13.2	4.85	4.45	1.85	4.0	8.0	2.0	12.0	Q3
SOT223	13"	12.4	6.765	7.335	1.88	4.0	8.0	2.0	12.0	Q3

NOTE:

1. All dimensions are nominal.
2. Plastic or metal protrusions of 0.15mm maximum per side are not included.

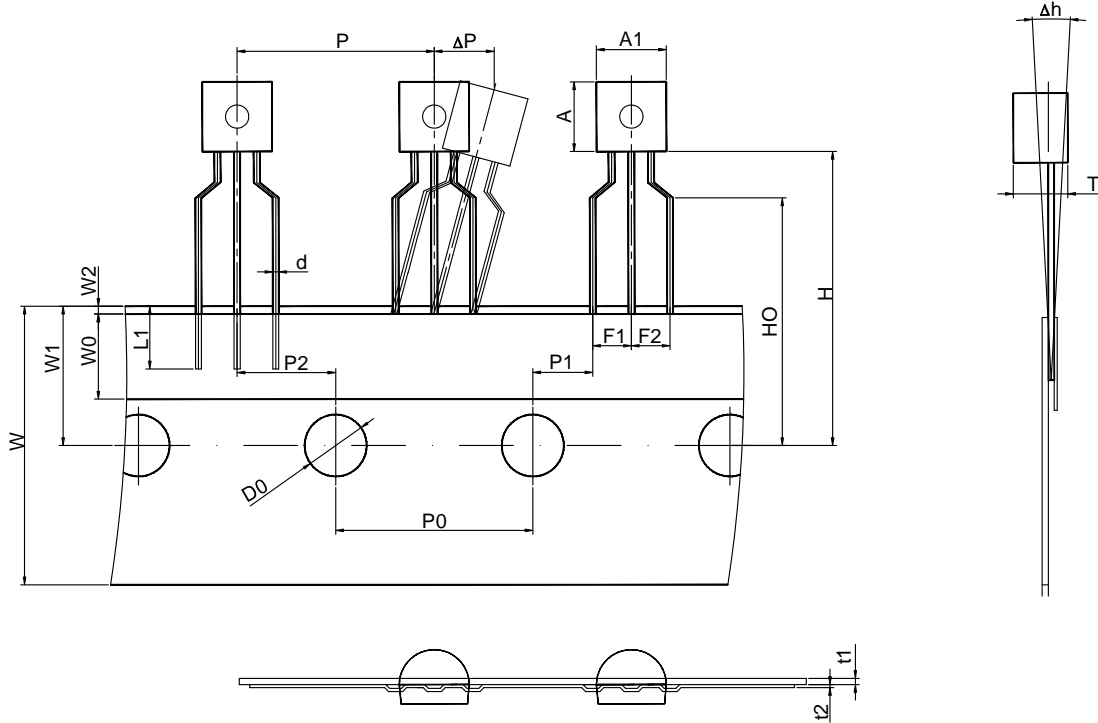
TAPE AND REEL INFORMATION (Continued)

TO-92

Item	Symbol	Value and Tolerance (Unit: mm)
Body width	A1	4.5 ± 0.2
Body height	A	4.5 ± 0.2
Body thickness	T	3.5 ± 0.1
Lead wire diameter	d	0.46 +0.09, -0.08
Pitch of component	P	12.7 ± 0.3
Feed hole pitch	P0	12.7 ± 0.2
Hole center to component center	P2	6.35 ± 0.3
Lead to lead distance	F1, F2	2.5 ± 0.3
Component alignment, F-R	Δh	0 ± 1.0
Type width	W	18.0 + 1.0, - 0.5
Hole down tape width	W0	6.0 ± 0.5
Hole position	W1	9.0 ± 0.5
Hole down tape position	W2	1.0 MAX
Height of component from tape center	H	19.0+2.0, -1.0
Lead wire clinch height	H0	16.0 ± 0.5
Lead wire (tape portion)	L1	2.5 MIN
Feed hole diameter	D0	4.0 ± 0.2
Carrier Tape Thickness	t1	0.4 ± 0.05
Taped Lead Thickness	t2	0.2 ± 0.05
Position of hole	P1	3.85 ± 0.3
Component alignment	ΔP	0 ± 1.0

IMPORTANT NOTICE AND DISCLAIMER

Jiangsu Runic Technology Co., Ltd. will accurately and reliably provide technical and reliability data (including data sheets), design resources (including reference designs), application or other design advice, WEB tools, safety information and other resources, without warranty of any defect, and will not make any express or implied warranty, including but not limited to the warranty of merchantability Implied warranty that it is suitable for a specific purpose or does not infringe the intellectual property rights of any third party.

These resources are intended for skilled developers designing with Runic products You will be solely responsible for: (1) Selecting the appropriate products for your application; (2) Designing, validating and testing your application; (3) Ensuring your application meets applicable standards and any other safety, security or other requirements; (4) Runic and the Runic logo are registered trademarks of Runic Incorporated. All trademarks are the property of their respective owners; (5) For change details, review the revision history included in any revised document. The resources are subject to change without notice. Our company will not be liable for the use of this product and the infringement of patents or third-party intellectual property rights due to its use.

X-ON Electronics

Largest Supplier of Electrical and Electronic Components

Click to view similar products for [Linear Voltage Regulators](#) category:

Click to view products by [RUNIC](#) manufacturer:

Other Similar products are found below :

[LV5684PVD-XH](#) [MCDTSA6-2R](#) [L7815ACV-DG](#) [LV56801P-E](#) [UA7805CKC](#) [714954EB](#) [ZMR500QFTA](#) [BA033LBSG2-TR](#)

[NCV78M05ABDTRKG](#) [LV5680P-E](#) [L79M05T-E](#) [L78LR05D-MA-E](#) [NCV317MBTG](#) [NTE7227](#) [MP2018GZD-33-P](#) [MP2018GZD-5-P](#)

[LV5680NPVC-XH](#) [ZTS6538SE](#) [UA78L09CLP](#) [UA78L09CLPR](#) [CAT6221-PPTD-GT3](#) [MC78M09CDTRK](#) [NCV51190MNTAG](#)

[BL1118CS8TR1833](#) [BL8563CKETR18](#) [BL8077CKETR33](#) [BL9153-33CC3TR](#) [BL9161G-15BADRN](#) [BL9161G-28BADRN](#)

[BRCO7530MMC](#) [CJ7815B-TFN-ARG](#) [LM317C](#) [GM7333K](#) [GM7350K](#) [XC6206P332MR](#) [HT7533](#) [LM7912S/TR](#) [LT1764S/TR](#) [LM7805T](#)

[LM338T](#) [LM1117IMP-3.3/TR](#) [HT1117AM-3.3](#) [HT7550S](#) [AMS1117-3.3](#) [HT7150S](#) [78L12](#) [HT7550](#) [HT7533-1](#) [HXY6206I-2.5](#) [HT7133](#)