

# 300mA LOW POWER LDO

## FEATURES

- Low Quiescent Current  $I_Q$ :  
3uA Typical at Light Loads
- 300mA Nominal Output Current
- Low Dropout Voltage
- Low Temperature Coefficient
- High Input Voltage (up to 45V)
- Output Voltage Accuracy:  $\pm 1\%/\pm 2\%$
- Fixed Output Voltage: 1.8V, 2.5V, 3.0V, 3.3V and 5.0V
- Over temperature protection and over-current protection function
- SOT23-3, SOT23-5, SOT89-3L and SOT223 Packages

## APPLICATIONS

- Smart Power Network Equipment
- Portable Power Tools
- BMS systems
- Motor control system/Industrial control system
- Power Meter/Instrument
- White Goods
- Vehicle-mounted system
- Fire fighting / security equipment
- Consumer products

## DESCRIPTION

The RS3007 series is a Low Dropout Linear Regulator designed by CMOS technology. Which can provide 300mA output current. The device allows input voltage as high as 45V. It is very suitable for multi-cell battery systems, bus voltage power supply systems, Vehicle battery power supply system and other high DC voltage systems. Wide input voltage can make it well withstand the impact of surge voltage and ensure the stability of output voltage.

The RS3007 series only consume 3uA (typical), Which is particularly important in battery power system, can reduce the standby power consumption of the whole system.

The RS3007 is available in Green SOT23-3, SOT23-5, SOT89-3L and SOT223 a variety of packages, for the different application's requirements.

Device Information <sup>(1)</sup>

PART NUMBER	PACKAGE	BODY SIZE (NOM)
RS3007	SOT23-3(3)	1.60mm×2.92mm
	SOT23-5(5)	1.60mm×2.92mm
	SOT89-3L(3)	2.45mm×4.50mm
	SOT223(3)	3.50mm x 7.00mm
	SOIC-8(8)	4.90mm x 3.90mm

(1) For all available packages, see the orderable addendum at the next page of the data sheet.

Typical Application Schematic

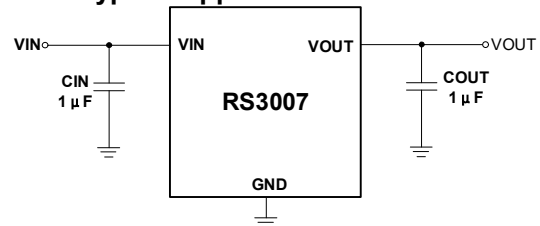

## Revision History

Note: Page numbers for previous revisions may differ from page numbers in the current version.

VERSION	Change Date	Change Item
A.1	2020/03/16	Initial version completed
A.2	2020/06/03	1) Added part-number to ordering information table 2) Added SOT223(L Type) package
A.3	2020/09/11	1) Added part-number to ordering information table 2) Added SOP8 package 3) Added 3.0 and 5.0 $V_{OUT}$ Accuracy of 1%

## Pin Configuration and Functions (Top View)

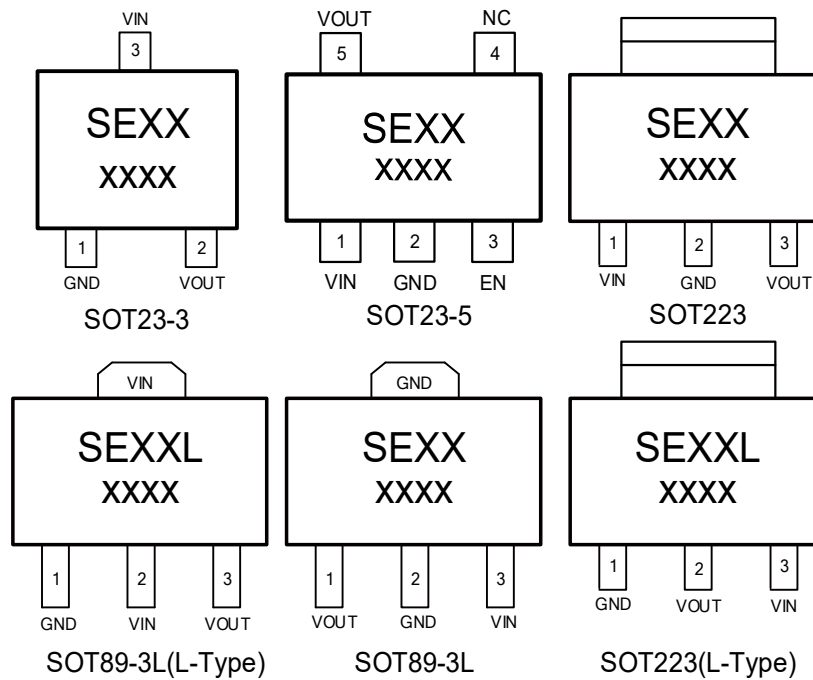

NOTE: XX indicate Output Voltage, xx indicate Data Code  
 For example: SE33 ( $V_{OUT}=3.3V$ )

### PIN DESCRIPTION

NAME	PIN						FUNCTION
	SOT23-3	SOT23-5	SOT89-3L (L-Type)	SOT89-3L	SOT223 (L-Type)	SOT223	
GND	1	2	1	2	1	2	Ground
VOUT	2	5	3	1	2	3	Regulator Output. Recommended output capacitor range: 1 $\mu$ F to 10 $\mu$ F.
VIN	3	1	2	3	3	1	Regulator Input. At least 1 $\mu$ F supply bypass capacitor is recommended.
EN	/	3	/	/	/	/	Enable pin. EN pin voltage is higher than $V_{EN(H)}$ enable output and lower than $V_{EN(L)}$ close output.
NC	/	4	/	/	/	/	No internal connection

### Pin Configuration and Functions (Top View)

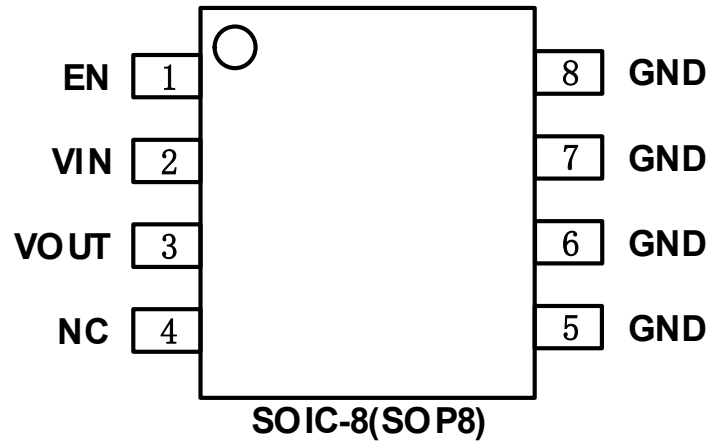

#### PIN DESCRIPTION

NAME	PIN	FUNCTION
	SOIC-8(SOP8)	
EN	1	Enable pin. EN pin voltage is higher than $V_{EN(H)}$ enable output and lower than $V_{EN(L)}$ close output.
VIN	2	Regulator Input. At least $1\mu F$ supply bypass capacitor is recommended.
VOUT	3	Regulator Output. Recommended output capacitor range: $1\mu F$ to $10\mu F$ .
NC	4	No internal connection
GND	5, 6, 7, 8	Ground

**PACKAGE/ORDERING INFORMATION**

PRODUCT	ORDERING NUMBER	V <sub>OUT</sub> (V)	V <sub>OUT</sub> Accuracy	PACKAGE LEAD	PACKAGE MARKING <sup>(1)</sup>	PACKAGE OPTION
RS3007-1.8	RS3007-1.8YF3	1.8	±2%	SOT23-3	SE18	Tape and Reel,3000
	RS3007-1.8SYF5	1.8	±2%	SOT23-5	SE18	Tape and Reel,3000
	RS3007-1.8YE3L	1.8	±2%	SOT89-3L L-Type	SE18L	Tape and Reel,1000
	RS3007-1.8YE3	1.8	±2%	SOT89-3L	SE18	Tape and Reel,1000
RS3007-2.5	RS3007-2.5YF3	2.5	±2%	SOT23-3	SE25	Tape and Reel,3000
	RS3007-2.5SYF5	2.5	±2%	SOT23-5	SE25	Tape and Reel,3000
	RS3007-2.5YE3L	2.5	±2%	SOT89-3L L-Type	SE25L	Tape and Reel,1000
	RS3007-2.5YE3	2.5	±2%	SOT89-3L	SE25	Tape and Reel,3000
RS3007-3.0	RS3007-3.0YF3	3.0	±2%	SOT23-3	SE30	Tape and Reel,3000
	RS3007-3.0SYF5	3.0	±2%	SOT23-5	SE30	Tape and Reel,3000
	RS3007-3.0YE3L	3.0	±2%	SOT89-3L L-Type	SE30L	Tape and Reel,1000
	RS3007-3.0YE3	3.0	±2%	SOT89-3L	SE30	Tape and Reel,1000
	RS3007-3.0YD3	3.0	±2%	SOT223	SE30	Tape and Reel,2500
	RS3007-3.0YD3L	3.0	±2%	SOT223 L-Type	SE30L	Tape and Reel,2500
RS3007-3.3	RS3007-3.3YF3	3.3	±2%	SOT23-3	SE33	Tape and Reel,3000
	RS3007-3.3SYF5	3.3	±2%	SOT23-5	SE33	Tape and Reel,3000
	RS3007-3.3YE3L	3.3	±2%	SOT89-3L L-Type	SE33L	Tape and Reel,1000
	RS3007-3.3YE3	3.3	±2%	SOT89-3L	SE33	Tape and Reel,1000
	RS3007-3.3YD3	3.3	±2%	SOT223	SE33	Tape and Reel,2500
	RS3007-3.3YD3L	3.3	±2%	SOT223 L-Type	SE33L	Tape and Reel,2500
RS3007-5.0	RS3007-5.0YF3	5.0	±2%	SOT23-3	SE50	Tape and Reel,3000
	RS3007-5.0SYF5	5.0	±2%	SOT23-5	SE50	Tape and Reel,3000
	RS3007-5.0YE3L	5.0	±2%	SOT89-3L L-Type	SE50L	Tape and Reel,1000
	RS3007-5.0YE3	5.0	±2%	SOT89-3L	SE50	Tape and Reel,1000
	RS3007-5.0YD3	5.0	±2%	SOT223	SE50	Tape and Reel,2500
	RS3007-5.0YD3L	5.0	±2%	SOT223 L-Type	SE50L	Tape and Reel,2500

PRODUCT	ORDERING NUMBER	V <sub>OUT</sub> (V)	V <sub>OUT</sub> Accuracy	PACKAGE LEAD	PACKAGE MARKING <sup>(1)</sup>	PACKAGE OPTION
RS3007-3.0	RS3007-3.0AYF3	3.0	±1%	SOT23-3	SE30	Tape and Reel,3000
	RS3007-3.0ASYF5	3.0	±1%	SOT23-5	SE30	Tape and Reel,3000
	RS3007-3.0AYK	3.0	±1%	SOIC-8	SE30	Tape and Reel,4000
RS3007-3.3	RS3007-3.3AYF3	3.3	±1%	SOT23-3	SE33	Tape and Reel,3000
	RS3007-3.3ASYF5	3.3	±1%	SOT23-5	SE33	Tape and Reel,3000
	RS3007-3.3AYK	3.3	±1%	SOIC-8	SE33L	Tape and Reel,4000
	RS3007-3.3AYD3	3.3	±1%	SOT223	SE33	Tape and Reel,2500
RS3007-5.0	RS3007-5.0AYF3	5.0	±1%	SOT23-3	SE50	Tape and Reel,3000
	RS3007-5.0ASYF5	5.0	±1%	SOT23-5	SE50	Tape and Reel,3000
	RS3007-5.0AYK	5.0	±1%	SOIC-8	SE50	Tape and Reel,4000

**NOTE:**

1.XXXX=Date Code and Vendor Code.

2.There may be additional marking, which relates to the lot trace code information(data code and vendor code) , the logo or the environmental category on the device.

## Specifications

### Absolute Maximum Ratings

over operating free-air temperature range (unless otherwise noted)<sup>(1)(2)</sup>

		MIN	MAX	UNIT
V <sub>IN</sub>	Input voltage	-0.3	55	V
V <sub>EN</sub>	V <sub>EN</sub> voltage range	-0.3	V <sub>IN</sub>	V
T <sub>J</sub>	PN Junction temperature	-40	175	°C
P <sub>D</sub>	Continuous power dissipation <sup>(3)</sup>	Internal thermal protection temperature limit		W
T <sub>stg</sub>	Storage temperature range	-55	150	°C

(1) Stresses beyond those listed under *Absolute Maximum Ratings* may cause permanent damage to the device. These are stress ratings only, and functional operation of the device at these or any other conditions beyond those indicated under *Recommended Operating Conditions* is not implied. Exposure to absolute-maximum-rated conditions for extended periods may affect device reliability.

(2) All voltages are with respect to the GND pin.

(3) Internal thermal shutdown circuitry protects the device from permanent damage. The actual chip output current is subject to the input-output voltage difference, ambient temperature and PCB heat dissipation design.

### ESD Ratings

		VALUE	UNIT	
V <sub>(ESD)</sub>	Electrostatic discharge	Human-body model (HBM)	±4000	V
		Charge device model (CDM)	±1500	V

### Recommended Operating Conditions

over operating free-air temperature range (unless otherwise noted)<sup>(1)</sup>

		MIN	MAX	UNIT
V <sub>IN</sub>	Input supply voltage	2.5	45	V
I <sub>OUT</sub>	Output current	0	300	mA
C <sub>IN</sub>	Capacitor of Vin pin	1	10	uF
C <sub>OUT</sub>	Capacitor of Vout pin	1	10	uF
ESR	Equivalent series resistance	5	100	mΩ
T <sub>A</sub>	Operating temperature	-40	+125 <sup>(2)</sup>	°C

(1) All voltages are with respect to the GND pin.

(2) The chip's operating temperature is determined by the junction temperature (T<sub>J</sub>), the relationship between T<sub>A</sub> and T<sub>J</sub>, please refer to the application note as below. The larger the T<sub>A</sub>, the smaller the space left for the chip temperature rise.

**Thermal Information**

THERMAL METRIC		RS3007						UNIT
		SOT23-3 SOT23-5	SOT89-3L	SOT89-3L (L-Type)	SOT223 (L-Type)	SOT223	SOIC-8	
		3 PINS/ 5 PINS	3 PINS	3 PINS	3 PINS	3 PINS	8 PIN	
R <sub>θJA</sub>	Junction-to-ambient thermal resistance	185.6	75	165	120	95	116	°C/W
R <sub>θJC(top)</sub>	Junction-to-case (top) thermal resistance	104.3	88.1	88.5	25	15	60	°C/W
R <sub>θJB</sub>	Junction-to-board thermal resistance	54.5	9.6	39.6	—	—	56	°C/W
ψ <sub>JT</sub>	Junction-to-top characterization parameter	31.0	6.2	26.5	—	—	12.8	°C/W
ψ <sub>JB</sub>	Junction-to-board characterization parameter	54.5	9.7	49.7	—	—	98.3	°C/W
R <sub>JC(bot)</sub>	Junction-to-case (bottom) thermal resistance	N/A	7.7	77.7	—	—	N/A	°C/W



## ELECTRICAL CHARACTERISTICS

( $V_{IN} = V_{OUT} + 2V$ ,  $C_{IN} = C_{OUT} = 1\mu F$ , Full =  $-40^{\circ}C$  to  $+85^{\circ}C$ , typical values are at  $T_A = +25^{\circ}C$ , unless otherwise noted.)

PARAMETER	SYMBOL	CONDITIONS	TEMP	MIN	TYP	MAX	UNITS	
Input Voltage	$V_{IN}$		$+25^{\circ}C$	2.5 <sup>(1)</sup>		45	V	
Output Voltage Accuracy <sup>(2)</sup>		$I_{OUT} = 10mA$	$+25^{\circ}C$	-2.0		2.0	%	
		$I_{OUT} = 10mA$ , A Type	$+25^{\circ}C$	-1.0		1.0	%	
Static power consumption	$I_Q$	$I_{OUT} = 0mA$	$+25^{\circ}C$		3.0	4.0	$\mu A$	
Shutdown Current	$I_{Q-OFF}$	$V_{EN} = 0V$	$+25^{\circ}C$		0.1	1.0	$\mu A$	
Output Current <sup>(3)</sup>			$+25^{\circ}C$	300	350	-	mA	
Dropout Voltage <sup>(4)</sup>	$V_{DROPOUT}$ $I_{OUT} = 100mA$	$V_{OUT} = 1.8V$	$+25^{\circ}C$	-	450	550	mV	
		$V_{OUT} = 2.5V$		-	385	485		
		$V_{OUT} = 3.0V$		-	350	450		
		$V_{OUT} = 3.3V$		-	335	435		
		$V_{OUT} = 5.0V$		-	300	400		
Line Regulation	$\frac{\Delta V_{OUT}}{\Delta V_{IN} \times V_{OUT}}$	$V_{IN} = V_{OUT} + 2V$ to $36V$ , $I_{OUT} = 1mA$	$+25^{\circ}C$	-	0.05	0.2	%/V	
Load Regulation	$\Delta V_{OUT}$	$V_{IN} = V_{OUT} + 1V$ , $I_{OUT} = 1mA$ to $50mA$	$+25^{\circ}C$	-	5	20	mV	
Output limiting current	$I_{LMT}$	$V_{IN} = V_{OUT} + 1V$	$+25^{\circ}C$	300	450	-	mA	
short-circuit Current	$I_{short}$	$V_{OUT} = 0$	$+25^{\circ}C$	-	100	-	mA	
Power Supply Rejection Ratio	PSRR	$V_{OUT} = 3.3V$ , $I_{OUT} = 10mA$	$+25^{\circ}C$	$f = 217Hz$	-	72	-	dB
				$f = 1KHz$	-	77	-	
				$f = 10KHz$	-	60	-	
Enable pin Threshold	$V_{ENH}$		$+25^{\circ}C$	1.2	-	-	V	
	$V_{ENL}$			-	-	0.4	V	
Output Voltage Temperature Coefficient <sup>(5)</sup>	$\frac{\Delta V_{OUT}}{\Delta T_A \times V_{OUT}}$	$I_{OUT} = 1mA$	FULL	-	100	-	ppm/ $^{\circ}C$	
Output Noise Voltage	eN	$V_{IN} = V_{OUT} + 1V$ , $I_{OUT} = 1mA$ , $V_{OUT} = 3.0V$ $f = 10Hz \sim 100KHz$		-	100	-	$\mu V_{rms}$	
Thermal Shutdown Temperature	$T_{SHDN}$			-	170	-	$^{\circ}C$	
Thermal Shutdown Hysteresis Temperature	$T_{SDH}$			-	20	-	$^{\circ}C$	

### NOTES:

- $V_{IN} \geq V_{OUT}$  (NOMINAL) or 2.5V, or higher voltage.
- Model A provides  $\pm 1\%$  precision output voltage.
- The maximum output current of the actual chip is subject to PCB heat dissipation design, input voltage, output voltage difference and ambient temperature.
- Under the condition of  $V_{IN} = V_{out} + 2V$  and a fixed load, the output voltage decreases by 2%. At this time, the input voltage minus the output voltage is the dropout voltage.
- Output voltage temperature coefficient is defined as the worst-case voltage change divided by the total temperature range.

## TYPICAL CHARACTERISTICS

( $V_{IN} = V_{OUT} + 2V$ ,  $C_{IN} = C_{OUT} = 1\mu F$ ,  $V_{OUT} = 3.3V$ , Full =  $-40^{\circ}C$  to  $+85^{\circ}C$ , typical values are at  $T_A = +25^{\circ}C$ , unless otherwise noted.)

Line Transient Response

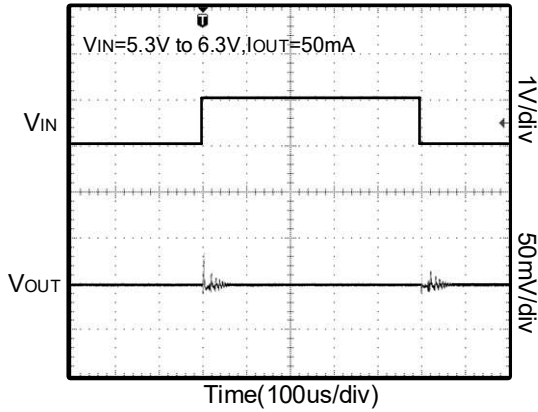

Power-Up/Power-Down Output Waveform

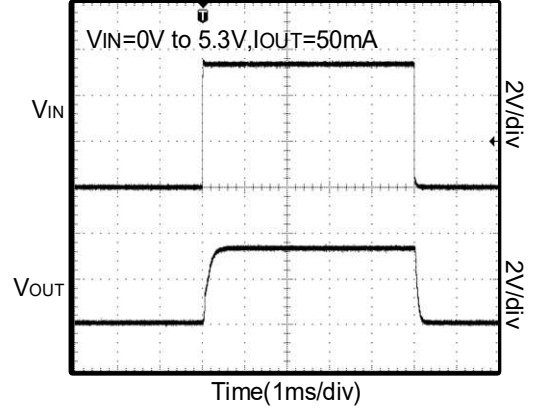

Load Transient Response

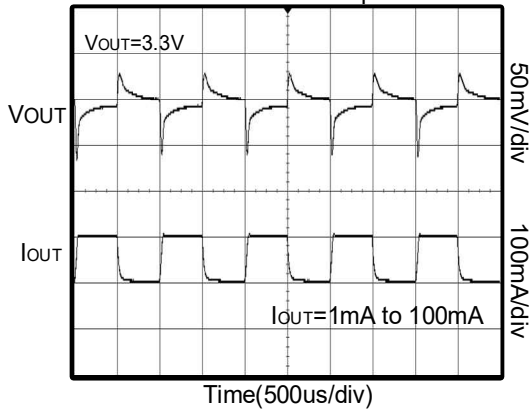

Load Transient Response

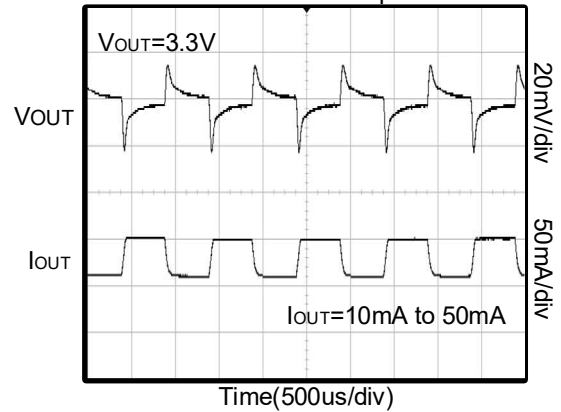

Line Regulation

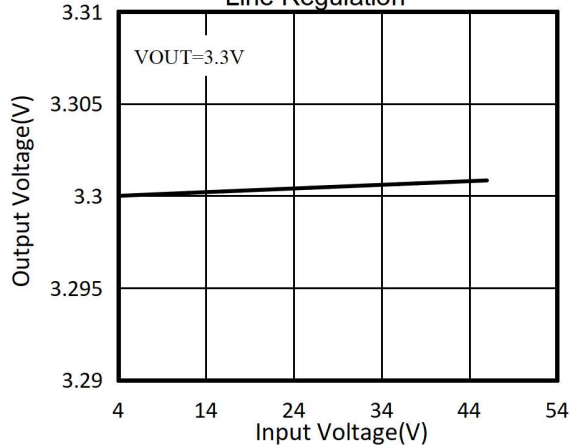

Load Regulation

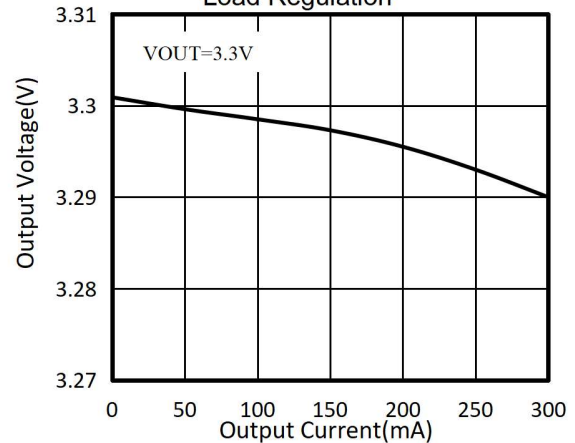

## TYPICAL CHARACTERISTICS

( $V_{IN} = V_{OUT} + 2V$ ,  $C_{IN} = C_{OUT} = 1\mu F$ ,  $V_{OUT} = 3.3V$ , Full =  $-40^{\circ}C$  to  $+85^{\circ}C$ , typical values are at  $T_A = +25^{\circ}C$ , unless otherwise noted.)

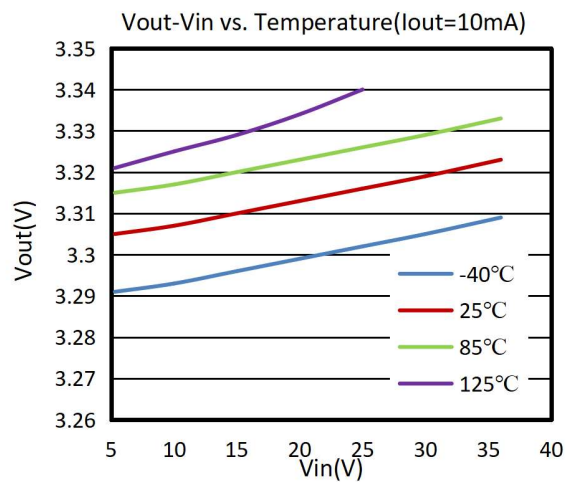
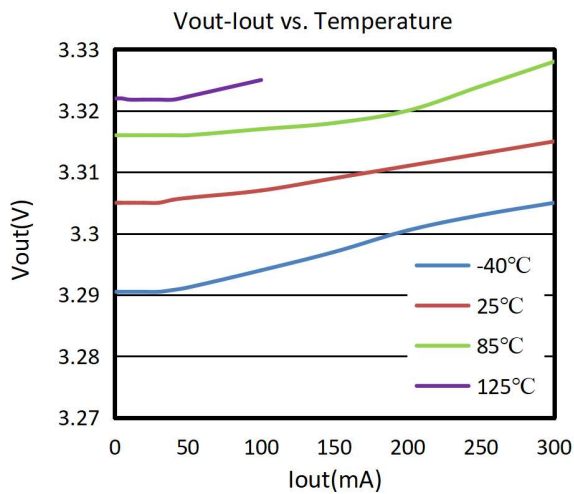
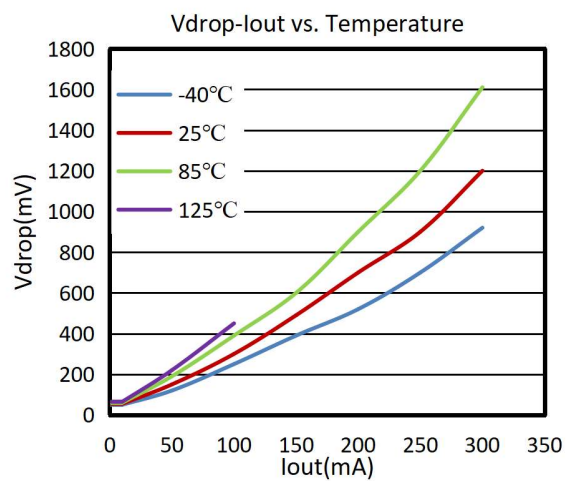
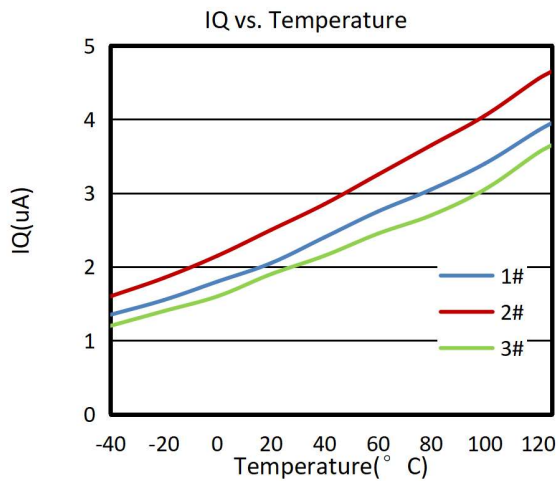
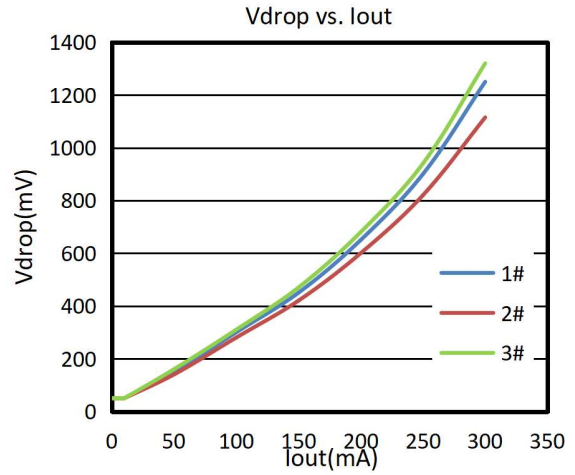
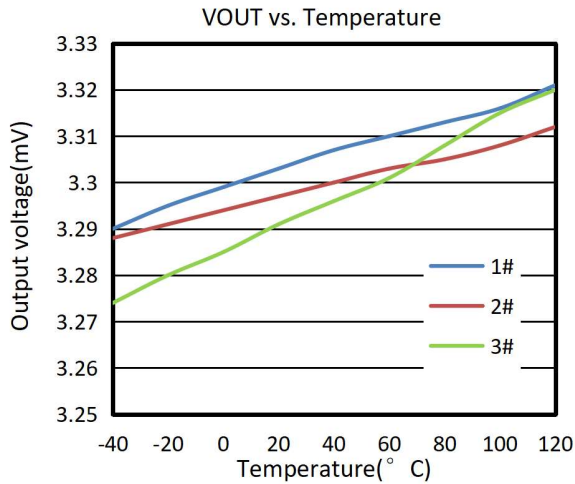

## Function introduction

RS3007 series low dropout linear regulator (LDO) consumes only 3.0uA of current and has excellent linear adjustment and load characteristics to meet the requirements of lower output noise and higher PSRR, making it more suitable for applications requiring ultra-low standby power consumption of the whole machine.

### Functional Block Diagram

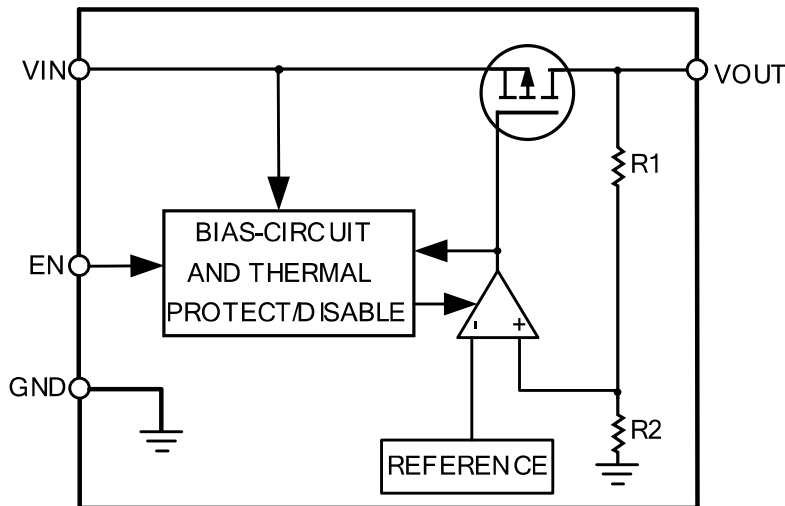

### Precautions for heat dissipation design

When the junction temperature of PN junction is too high and reaches the set temperature value, it will trigger the thermal protection circuit to send a signal to the control logic to turn off the chip output. When the PN junction temperature is lower than the set protection temperature, the chip will restart automatically. The maximum output power actually provided by the chip depends on the heat dissipation design of the system, including ambient temperature, wiring thickness and layout, and cooling design, such as adding heat sink and air cooling. Increasing the PCB area of GND pin can also obtain better heat dissipation performance.

### Other application considerations

1) The phase compensation circuit and ESR of the output capacitor are used inside the circuit to compensate, so a capacitor larger than 1.0uF must be connected to the ground.

2) It is recommended to use 1uF polar capacitors for input and output, and to keep the capacitors as close to the  $V_{IN}$  and  $V_{OUT}$  pins of LDO as possible.

3) Pay attention to the service conditions of input and output voltage and load current to make the junction temperature lower than the overheat protection temperature ( $T_{SHDN}$ ).

Approximate estimation method of the junction temperature ( $T_J$ ):

$$T_J = (V_{IN} - V_{OUT}) \times I_{OUT} \times R_{\theta JA} + T_A$$

$I_{OUT}$  is the Load current

$R_{\theta JA}$  is the Junction-to-ambient thermal resistance

$T_A$  is the ambient temperature.

Only when the  $T_J < T_{SHDN}$ , the chip will not trigger the over-temperature protection function.

4) When the input voltage  $V_{IN}$  is greater than 2.5V, if  $V_{IN}$  is also higher than the output set value plus the device dropout voltage,  $V_{OUT}$  is equal to the set value. Otherwise,  $V_{OUT}$  is equal to  $V_{IN}$  minus the dropout voltage. If  $V_{IN}$  lower than 2.5V, the  $V_{OUT}$  is:

$$V_{OUT} = V_{IN} - V_{Dropout}$$

$V_{Dropout}$  is converted according to the actual load current and basically maintains a linear relationship.

# PACKAGE OUTLINE DIMENSIONS

## SOT23-3

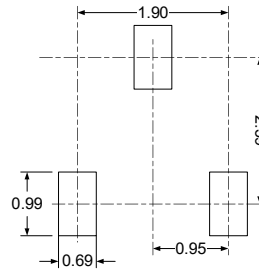
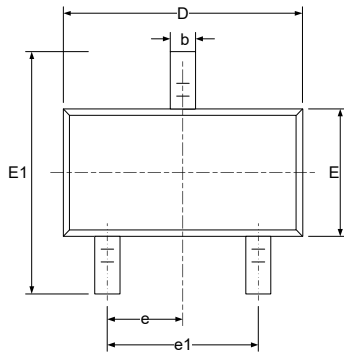
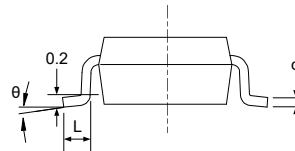
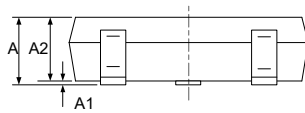
**RECOMMENDED LAND PATTERN (Unit: mm)**

Symbol	Dimensions In Millimeters		Dimensions In Inches	
	Min	Max	Min	Max
A	1.050	1.250	0.041	0.049
A1	0.000	0.100	0.000	0.004
A2	1.050	1.150	0.041	0.045
b	0.300	0.500	0.012	0.020
c	0.100	0.200	0.004	0.008
D	2.820	3.020	0.111	0.119
E	1.500	1.700	0.059	0.067
E1	2.650	2.950	0.104	0.116
e	0.950(BSC)		0.037(BSC)	
e1	1.800	2.000	0.071	0.079
L	0.300	0.600	0.012	0.024
$\theta$	0°	8°	0°	8°

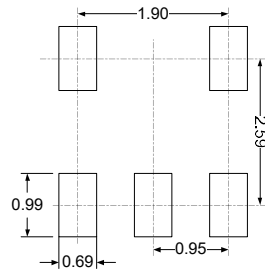
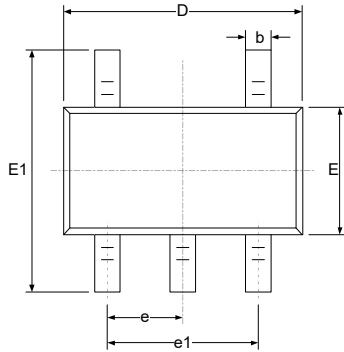
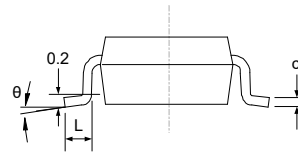
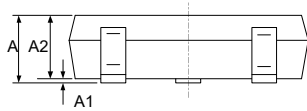
**SOT23-5**

**RECOMMENDED LAND PATTERN (Unit: mm)**

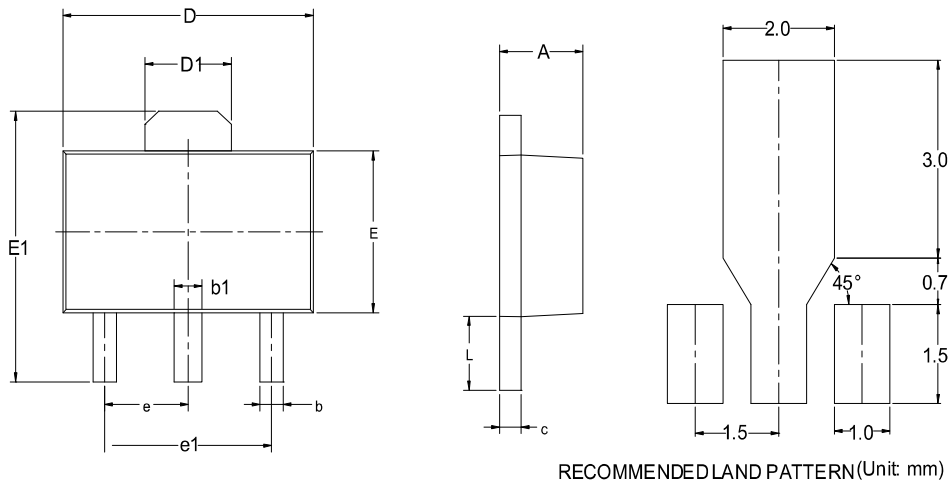
Symbol	Dimensions In Millimeters		Dimensions In Inches	
	Min	Max	Min	Max
A	1.050	1.250	0.041	0.049
A1	0.000	0.100	0.000	0.004
A2	1.050	1.150	0.041	0.045
b	0.300	0.500	0.012	0.020
c	0.100	0.200	0.004	0.008
D	2.820	3.020	0.111	0.119
E	1.500	1.700	0.059	0.067
E1	2.650	2.950	0.104	0.116
e	0.950(BSC)		0.037(BSC)	
e1	1.800	2.000	0.071	0.079
L	0.300	0.600	0.012	0.024
θ	0°	8°	0°	8°

**SOT89-3L**

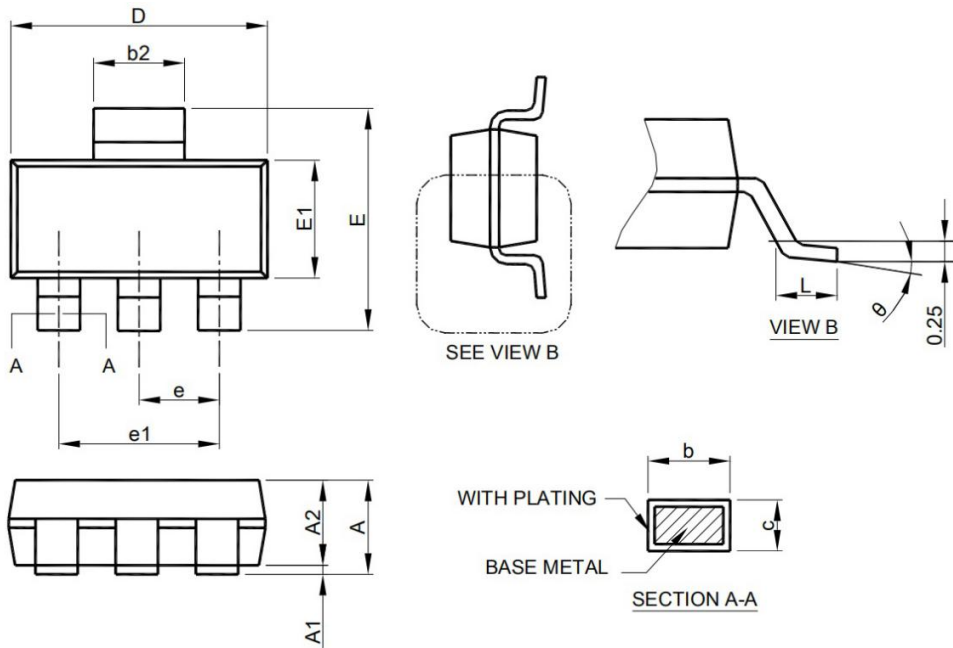
Symbol	Dimensions In Millimeters		Dimensions In Inches	
	Min	Max	Min	Max
A	1.400	1.600	0.055	0.063
b	0.320	0.520	0.013	0.020
b1	0.400	0.580	0.016	0.023
c	0.350	0.440	0.014	0.017
D	4.400	4.600	0.173	0.181
D1	1.550 REF		0.061 REF	
E	2.300	2.600	0.091	0.102
E1	3.940	4.250	0.155	0.167
e	1.500 BSC		0.060 BSC	
e1	3.000 BSC		0.118 BSC	
L	0.900	1.200	0.035	0.047

**SOT223**

Symbol	Dimensions In Millimeters		Dimensions In Inches	
	Min	Max	Min	Max
A	-	1.800	-	0.071
A1	0.02	0.10	0.001	0.004
A2	1.55	1.65	0.061	0.065
b	0.66	0.84	0.026	0.033
b2	2.90	3.10	0.114	0.122
c	0.23	0.33	0.009	0.013
D	6.30	6.70	0.248	0.263
E	6.70	7.30	0.263	0.287
E1	3.30	3.70	0.130	0.145
e	2.30 BSC		0.090 BSC	
e1	4.60 BSC		0.181 BSC	
L	0.90	-	0.035	-

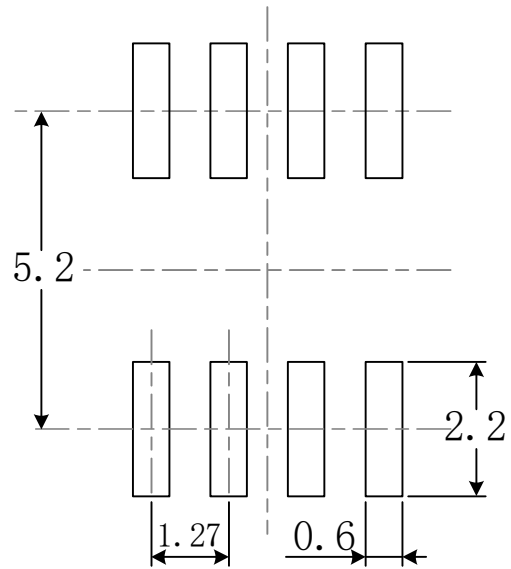
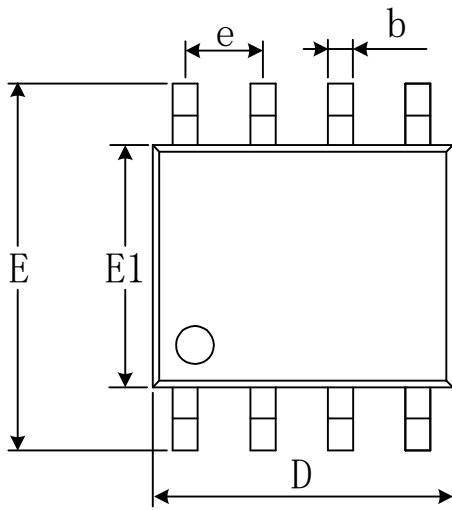
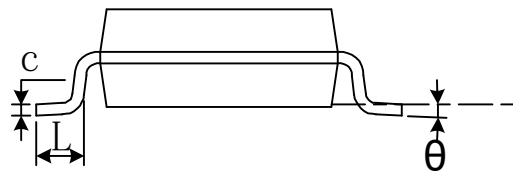
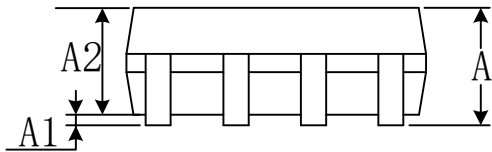

**SOIC-8(SOP8)**

**RECOMMENDED LAND PATTERN** (Unit: mm)

Symbol	Dimensions In Millimeters		Dimensions In Inches	
	Min	Max	Min	Max
A	1.350	1.750	0.053	0.069
A1	0.100	0.250	0.004	0.010
A2	1.350	1.550	0.053	0.061
b	0.330	0.510	0.013	0.020
c	0.170	0.250	0.007	0.010
D	4.800	5.000	0.189	0.197
e	1.270(BSC)		0.050(BSC)	
E	5.800	6.200	0.228	0.244
E1	3.800	4.000	0.150	0.157
L	0.400	1.270	0.016	0.050
$\theta$	0°	8°	0°	8°

## X-ON Electronics

Largest Supplier of Electrical and Electronic Components

*Click to view similar products for [Linear Voltage Regulators](#) category:*

*Click to view products by [RUNIC](#) manufacturer:*

Other Similar products are found below :

[LV5684PVD-XH](#) [MCDTSA6-2R](#) [L7815ACV-DG](#) [LV56801P-E](#) [UA7805CKC](#) [714954EB](#) [ZMR500QFTA](#) [BA033LBSG2-TR](#)

[NCV78M05ABDTRKG](#) [LV5680P-E](#) [L79M05T-E](#) [L78LR05D-MA-E](#) [NCV317MBTG](#) [NTE7227](#) [MP2018GZD-33-P](#) [MP2018GZD-5-P](#)

[LV5680NPVC-XH](#) [ZTS6538SE](#) [UA78L09CLP](#) [UA78L09CLPR](#) [CAT6221-PPTD-GT3](#) [MC78M09CDTRK](#) [NCV51190MNTAG](#)

[BL1118CS8TR1833](#) [BL8563CKETR18](#) [BL8077CKETR33](#) [BL9153-33CC3TR](#) [BL9161G-15BADRN](#) [BL9161G-28BADRN](#)

[BRCO7530MMC](#) [CJ7815B-TFN-ARG](#) [LM317C](#) [GM7333K](#) [GM7350K](#) [XC6206P332MR](#) [HT7533](#) [LM7912S/TR](#) [LT1764S/TR](#) [LM7805T](#)

[LM338T](#) [LM1117IMP-3.3/TR](#) [HT1117AM-3.3](#) [HT7550S](#) [AMS1117-3.3](#) [HT7150S](#) [78L12](#) [HT7550](#) [HT7533-1](#) [HXY6206I-2.5](#) [HT7133](#)