

300mA, Low Power Consumption, High Voltage CMOS LDO Regulator

FEATURES

- Low Quiescent Current I_Q : 3 μ A (Typ.)
- 300mA Nominal Output Current
- Low Dropout Voltage
- Low Temperature Coefficient
- High Input Voltage (up to 45V)
- Output Voltage Accuracy: $\pm 1\%/\pm 2\%$
- Fixed Output Voltage: 1.8V, 2.5, 3.0, 3.3V and 5.0V
- Current Limit Protection
- Over Temperature Protection
- SOT23-3, SOT23-5, SOT89-3L and SOT223 Packages

APPLICATIONS

- Smart Power Network Equipment
- Portable Power Tools
- BMS systems
- Motor control system/Industrial control system
- Power Meter/Instrument
- White Goods
- Vehicle-mounted system
- Battery-Powered Equipment
- Automotive Head Unit
- Security Equipment
- Communication Equipment

DESCRIPTION

The RS3007 series is a set of low power high voltage regulators implemented in CMOS technology. Which can provide 300mA output current. The device allows input voltage as high as 45V. It is very suitable for multi-cell battery systems, bus voltage power supply systems and other high DC voltage systems. Wide input voltage can make it well withstand the impact of surge voltage and ensure the stability of output voltage.

The RS3007 series only consume 3 μ A (typical), Which is particularly important in battery power system, can reduce the standby power consumption of the whole system.

The RS3007 is available in Green SOT23-3, SOT23-5, SOT89-3L and SOT223 packages, for the different application's requirements.

Device Information (1)

PART NUMBER	PACKAGE	BODY SIZE (NOM)
RS3007	SOT23-3(3)	1.60mm×2.92mm
	SOT23-5(5)	1.60mm×2.92mm
	SOT89-3L(3)	2.45mm×4.50mm
	SOT223(3)	3.50mm x 7.00mm

(1) For all available packages, see the orderable addendum at the next page of the data sheet.

Typical Application Schematic

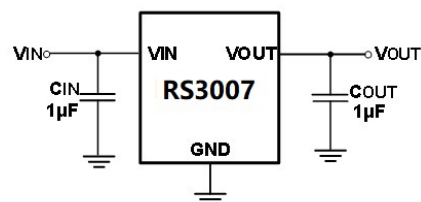

Pin Configuration and Functions (Top View)

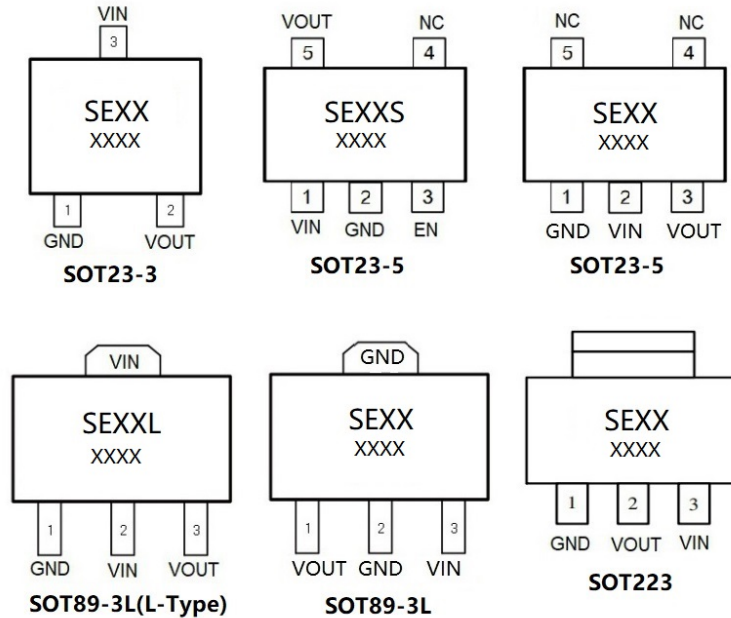

NOTE: XX indicate Output Voltage, xx indicate Data Code
For example: SE33(V_{out}=3.3V)

PIN DESCRIPTION

NAME	PIN						FUNCTION
	SOT23-3	SOT23-5 (S)	SOT23-5	SOT89-3L (L-Type)	SOT89-3L	SOT223	
GND	1	2	1	1	2	1	Ground
VOUT	2	5	3	3	1	2	Regulator Output. Recommended output capacitor range: 1μF to 10μF.
VIN	3	1	2	2	3	3	Regulator Input. Up to 45V input voltage. At least 1μF supply bypass capacitor is recommended.
EN	/	3	/	/	/	/	Enable pin. Drive this pin high to enable the device, Low to put the device into low current shutdown.
NC	/	4	4/5	/	/	/	No internal connection

PACKAGE/ORDERING INFORMATION

PRODUCT	ORDERING NUMBER	V _{out} (V)	PACKAGE LEAD	PACKAGE MARKING	PACKAGE OPTION
RS3007-1.8	RS3007-1.8YF3	1.8	SOT23-3	SE18 XXXX	Tape and Reel,3000
	RS3007-1.8SYF5	1.8	SOT23-5	SE18 XXXX	Tape and Reel,3000
	RS3007-1.8YE3L	1.8	SOT89-3L L-Type	SE18L XXXX	Tape and Reel,1000
	RS3007-1.8YE3	1.8	SOT89-3L	SE18 XXXX	Tape and Reel,1000
RS3007-2.5	RS3007-2.5YF3	2.5	SOT23-3	SE25 XXXX	Tape and Reel,3000
	RS3007-2.5SYF5	2.5	SOT23-5	SE25 XXXX	Tape and Reel,3000
	RS3007-2.5YE3L	2.5	SOT89-3L L-Type	SE25L XXXX	Tape and Reel,1000
	RS3007-2.5YE3	2.5	SOT89-3L	SE25 XXXX	Tape and Reel,3000
RS3007-3.0	RS3007-3.0YF3	3.0	SOT23-3	SE30 XXXX	Tape and Reel,3000
	RS3007-3.0SYF5	3.0	SOT23-5	SE30 XXXX	Tape and Reel,3000
	RS3007-3.0YE3L	3.0	SOT89-3L L-Type	SE30L XXXX	Tape and Reel,1000
	RS3007-3.0YE3	3.0	SOT89-3L	SE30 XXXX	Tape and Reel,1000
	RS3007-3.0YD3	3.0	SOT223	SE30 XXXX	Tape and Reel,1000
RS3007-3.3	RS3007-3.3YF3	3.3	SOT23-3	SE33 XXXX	Tape and Reel,3000
	RS3007-3.3SYF5	3.3	SOT23-5	SE33 XXXX	Tape and Reel,3000
	RS3007-3.3YF5	3.3	SOT23-5	SE33 XXXX	Tape and Reel,3000
	RS3007-3.3YE3L	3.3	SOT89-3L L-Type	SE33L XXXX	Tape and Reel,1000
	RS3007-3.3YE3	3.3	SOT89-3L	SE33 XXXX	Tape and Reel,1000
	RS3007-3.3YD3	3.3	SOT223	SE33 XXXX	Tape and Reel,1000
RS3007-5.0	RS3007-5.0YF3	5.0	SOT23-3	SE50 XXXX	Tape and Reel,3000
	RS3007-5.0SYF5	5.0	SOT23-5	SE50 XXXX	Tape and Reel,3000
	RS3007-5.0YF5	5.0	SOT23-5	SE50 XXXX	Tape and Reel,3000
	RS3007-5.0YE3L	5.0	SOT89-3L L-Type	SE50L XXXX	Tape and Reel,1000
	RS3007-5.0YE3	5.0	SOT89-3L	SE50 XXXX	Tape and Reel,1000
	RS3007-5.0YD3	5.0	SOT223	SE50 XXXX	Tape and Reel,1000

NOTE:

- 1.XXXX = Date Code and Vendor Code.
2. Letter A represent the out voltage accuracy is $\pm 1\%$,
for example, RS3007-3.3AYE3 ,V_{out} = 3.3V $\pm 1\%$, SOT89-3L package.

Specifications

Absolute Maximum Ratings

over operating free-air temperature range (unless otherwise noted) ⁽¹⁾⁽²⁾

		MIN	MAX	UNIT
V _{IN}	Input voltage	-0.3	55	V
V _{EN}	Enable input voltage	-0.3	V _{IN}	V
T _J	Junction temperature	-40	175	°C
P _D	Continuous power dissipation ⁽³⁾	Internally Limited		W
T _{stg}	Storage temperature	-65	150	°C

(1) Stresses beyond those listed under *Absolute Maximum Ratings* may cause permanent damage to the device. These are stress ratings only, and functional operation of the device at these or any other conditions beyond those indicated under *Recommended Operating Conditions* is not implied. Exposure to absolute-maximum-rated conditions for extended periods may affect device reliability.

(2) All voltages are with respect to the GND pin.

(3) Internal thermal shutdown circuitry protects the device from permanent damage.

ESD Ratings

		VALUE	UNIT	
V _(ESD)	Electrostatic discharge	Human-body model (HBM)	4000	V
		Charge device model (CDM)	1500	V

Recommended Operating Conditions

over operating free-air temperature range (unless otherwise noted) ⁽¹⁾

		MIN	MAX	UNIT
V _{IN}	Input supply voltage	2.5	45	V
I _{OUT}	Output current	0	300	mA
C _{IN}	Capacitor of Vin pin	1	10	µF
C _{OUT}	Capacitor of Vout pin	1	10	µF
ESR	Equivalent series resistance	5	100	mΩ
T _A	Operating temperature	-40	+85	°C

(1) All voltages are with respect to the GND pin.

Thermal Information

THERMAL METRIC		RS3007				UNIT
		SOT23-3 SOT23-5	SOT89-3L	SOT89-3L (L-Type)	SOT223	
		3 PINS/ 5 PINS	3 PINS	3 PINS	3 PINS	
R _{θJA}	Junction-to-ambient thermal resistance	185.6	75	165	120	°C/W
R _{θJC(top)}	Junction-to-case (top) thermal resistance	104.3	88.1	88.5	15	°C/W
R _{θJB}	Junction-to-board thermal resistance	54.5	9.6	39.6	—	°C/W
ψ _{JT}	Junction-to-top characterization parameter	31.0	6.2	26.5	—	°C/W
ψ _{JB}	Junction-to-board characterization parameter	54.5	9.7	49.7	—	°C/W
R _{JC(bot)}	Junction-to-case (bottom) thermal resistance	N/A	7.7	77.7	—	°C/W

ELECTRICAL CHARACTERISTICS

($V_{IN} = V_{OUT} + 2V$, $C_{IN} = C_{OUT} = 1\mu F$, $V_{OUT} = 3.3V$, Full = $-40^{\circ}C$ to $+85^{\circ}C$, typical values are at $T_A = +25^{\circ}C$, unless otherwise noted.)

PARAMETER	SYMBOL	CONDITIONS	TEMP	MIN	TYP	MAX	UNITS	
Input Voltage	V_{IN}		$+25^{\circ}C$	2.5 ⁽¹⁾		45	V	
Output Voltage Accuracy ⁽²⁾		$I_{OUT} = 10mA$	$+25^{\circ}C$	-2.0		2.0	%	
		$I_{OUT} = 10mA$, A Type	$+25^{\circ}C$	-1.0		1.0	%	
Ground Pin Current	I_Q	No load	$+25^{\circ}C$		3.0	4.0	μA	
Shutdown Current	I_{Q-OFF}	$V_{EN} = 0V$	$+25^{\circ}C$		0.1	1.0	μA	
Max Output Current ⁽³⁾			$+25^{\circ}C$	300	350	-	mA	
Dropout Voltage ⁽⁴⁾	V_{DROP} $I_{OUT} = 100mA$	$V_{OUT} = 1.8V$	$+25^{\circ}C$	-	450	550	mV	
		$V_{OUT} = 2.5V$		-	385	485		
		$V_{OUT} = 3.0V$		-	350	450		
		$V_{OUT} = 3.3V$		-	335	435		
		$V_{OUT} = 5.0V$		-	300	400		
Line Regulation	$\frac{\Delta V_{OUT}}{\Delta V_{IN} \times V_{OUT}}$	$V_{IN} = V_{OUT} + 2V$ to $36V$, $I_{OUT} = 1mA$	$+25^{\circ}C$	-	0.05	0.2	%/V	
Load Regulation	ΔV_{OUT}	$V_{IN} = V_{OUT} + 1V$, $I_{OUT} = 1mA$ to $50mA$	$+25^{\circ}C$	-	5	20	mV	
Output Current Limit	I_{LMT}	$V_{IN} = V_{OUT} + 1V$	$+25^{\circ}C$	300	450	-	mA	
Short Current	I_{short}	$V_{OUT} = 0$	$+25^{\circ}C$	-	100	-	mA	
Power Supply Rejection Ratio	PSRR	$V_{OUT} = 3.3V$, $I_{OUT} = 10mA$	$+25^{\circ}C$	$f = 217Hz$	-	72	-	dB
				$f = 1KHz$	-	77	-	
				$f = 10KHz$	-	60	-	
EN Input Threshold	V_{ENH}		$+25^{\circ}C$	1.2	-	-	V	
	V_{ENL}			-	-	0.4	V	
Output Voltage Temperature Coefficient ⁽⁵⁾	$\frac{\Delta V_{OUT}}{\Delta T_A \times V_{OUT}}$	$I_{OUT} = 1mA$	FULL	-	100	-	ppm/ $^{\circ}C$	
Output Noise Voltage	eN	$V_{IN} = V_{OUT} + 1V$, $I_{OUT} = 1mA$, $V_{OUT} = 3.0V$ $f = 10Hz \sim 100KHz$		-	100	-	μV_{rms}	
Thermal Shutdown Temperature	T_{SHDN}			-	170	-	$^{\circ}C$	
Thermal Shutdown Hysteresis	T_{SDH}			-	20	-	$^{\circ}C$	

NOTES:

- $V_{IN} \geq V_{OUT (NOMINAL)}$, whichever is greater.
- Option $\pm 1\%$ output voltage accuracy.
- Maximum output current is affected by the PCB layout, size of metal trace, the thermal conduction path between metal layers, ambient temperature and the other environment factors of system. Attention should be paid to the dropout voltage when $V_{IN} < V_{OUT} + V_{DROP}$.
- The dropout voltage is defined as $V_{IN} - V_{OUT}$, when V_{OUT} is 100mV below the value of V_{OUT} for $V_{IN} = V_{OUT (NOMINAL)} + 2V$.
- Output voltage temperature coefficient is defined as the worst-case voltage change divided by the total temperature range.

TYPICAL CHARACTERISTICS

($V_{IN} = V_{OUT} + 2V$, $C_{IN} = C_{OUT} = 1\mu F$, $V_{OUT} = 3.3V$, Full = $-40^{\circ}C$ to $+85^{\circ}C$, typical values are at $T_A = +25^{\circ}C$, unless otherwise noted.)

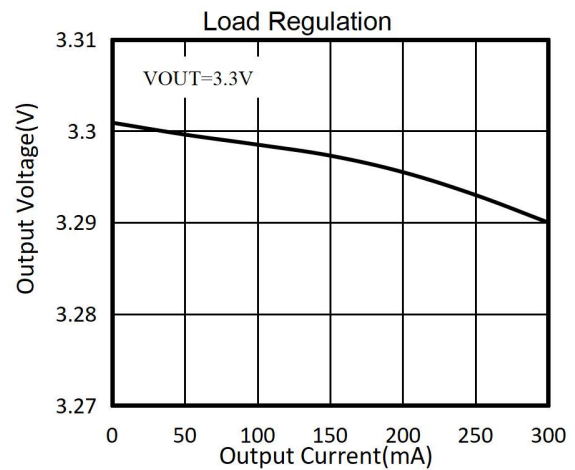
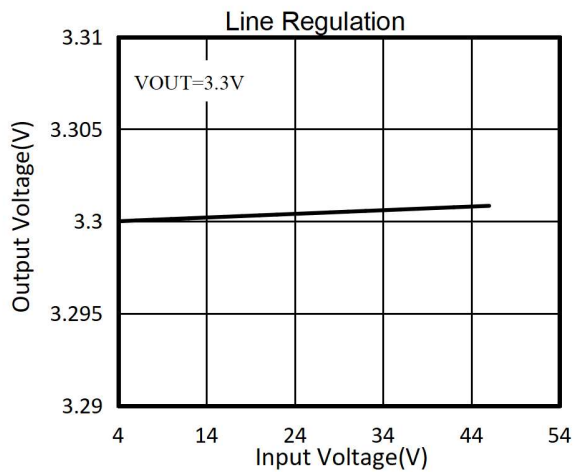
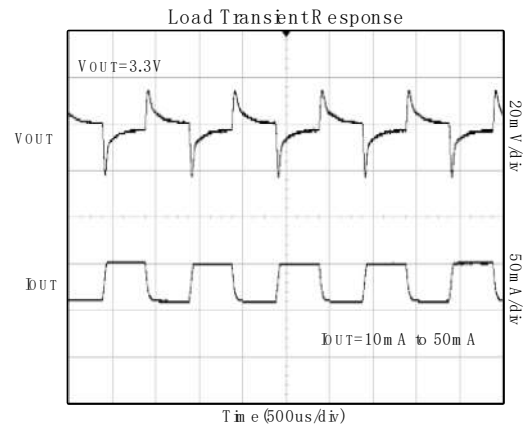
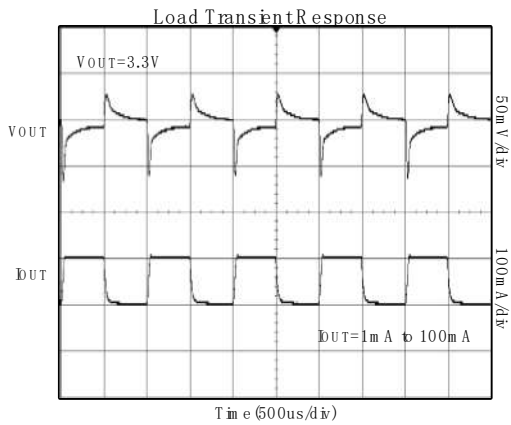
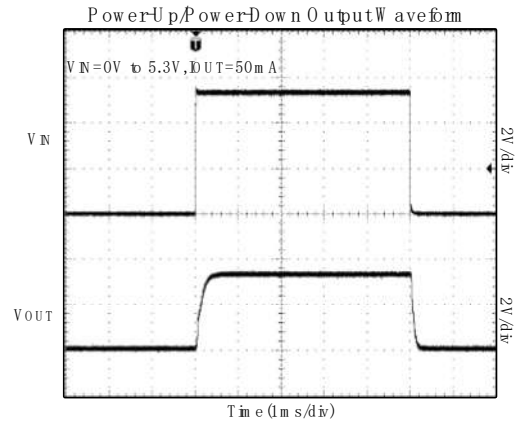
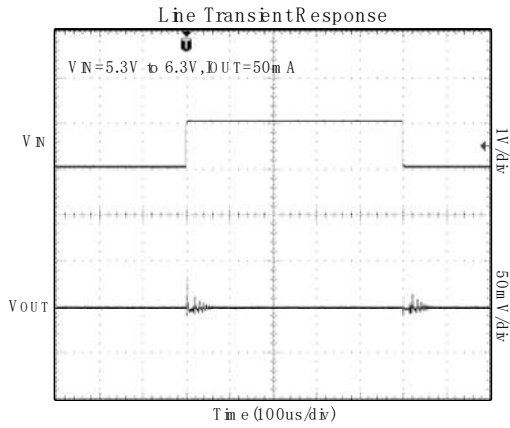

TYPICAL CHARACTERISTICS

($V_{IN} = V_{OUT} + 2V$, $C_{IN} = C_{OUT} = 1\mu F$, $V_{OUT} = 3.3V$, Full = $-40^{\circ}C$ to $+85^{\circ}C$, typical values are at $T_A = +25^{\circ}C$, unless otherwise noted.)

Vdrop vs. Iout

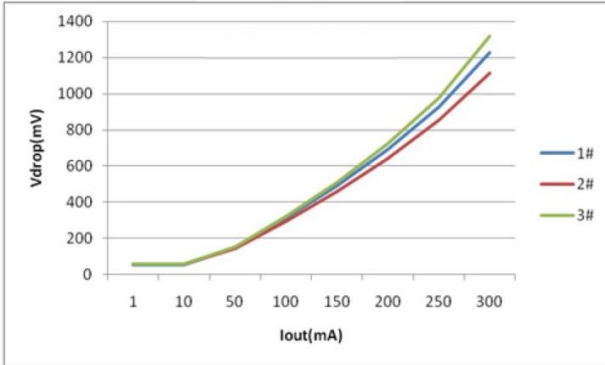

Vout vs. Temperature

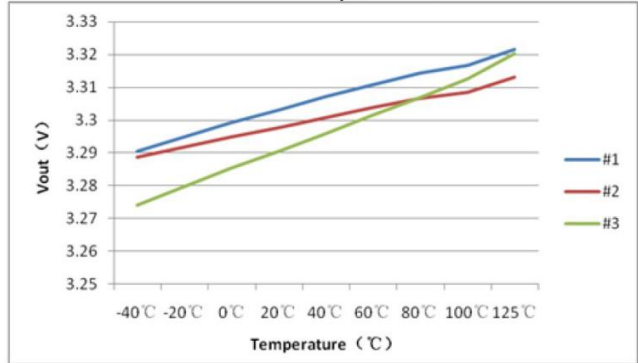

Iq vs. Temperature

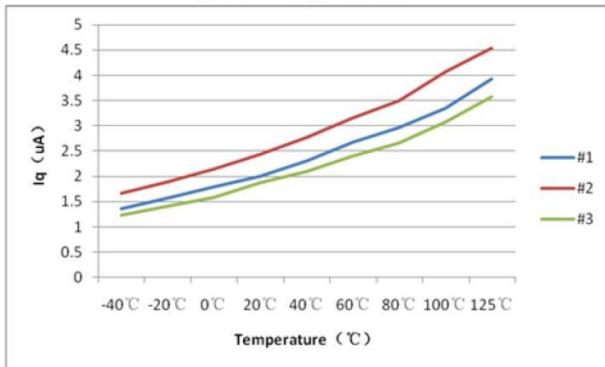

Vdrop - Iout vs. Temperature

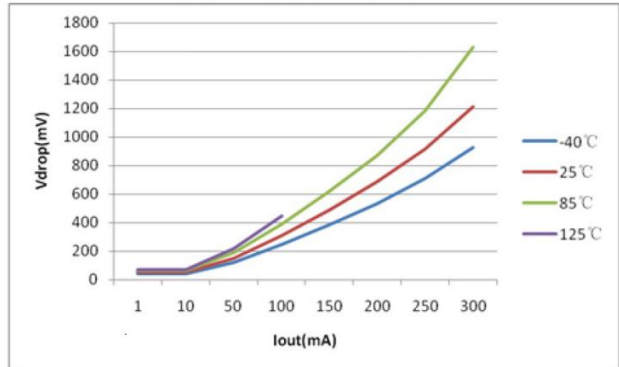

Vout - Vin vs. Temperature (Iout = 1mA)

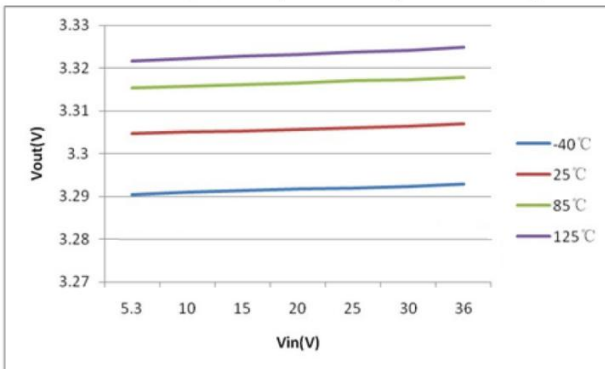

Vout - Vin vs. Temperature (Iout = 10mA)

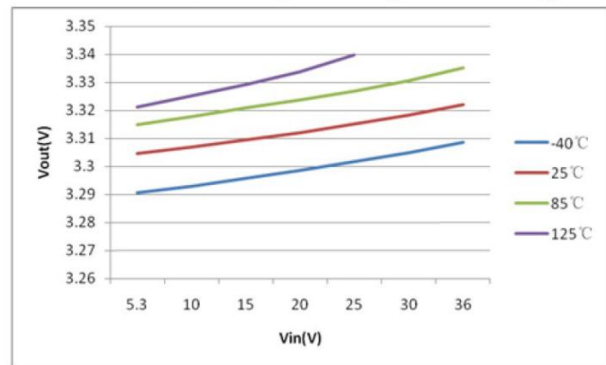

TYPICAL CHARACTERISTICS

($V_{IN} = V_{OUT} + 2V$, $C_{IN} = C_{OUT} = 1\mu F$, $V_{OUT} = 3.3V$, Full = $-40^{\circ}C$ to $+85^{\circ}C$, typical values are at $T_A = +25^{\circ}C$, unless otherwise noted.)

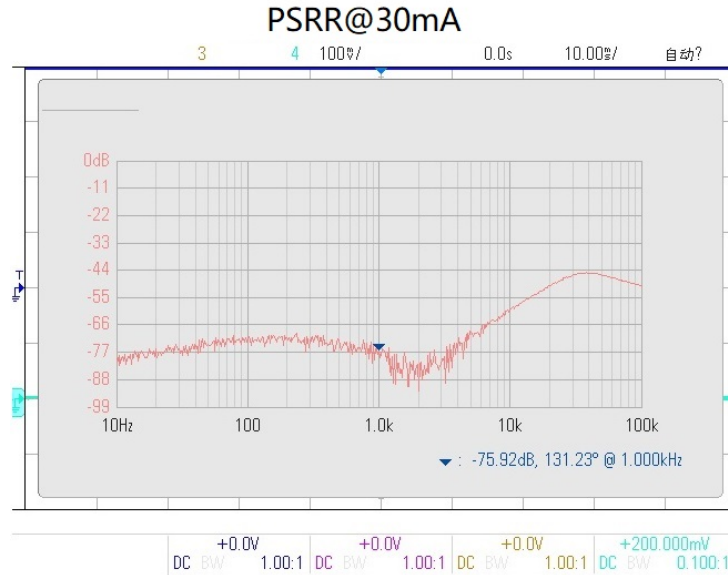

DETAILED DESCRIPTION

Overview

The RS3007 low-dropout regulators (LDO) consumes only $3\mu A$ of quiescent current at light load and delivers excellent line and load transient performance. These characteristics, combined with low noise and good PSRR with low dropout voltage, make this device ideal for portable consumer applications.

Functional Block Diagram

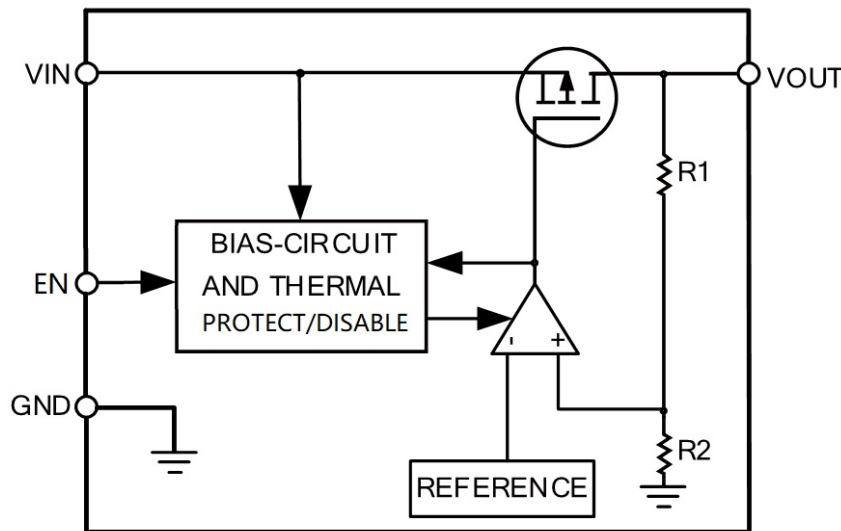

Thermal Considerations

When the junction temperature is too high, the thermal protection circuitry sends a signal to the control logic that will shut down the IC. The IC will restart when the temperature has sufficiently cooled down. The maximum power dissipation is dependent on the thermal resistance of the case and the circuit board, the temperature difference between the die junction and the ambient air, and the rate of air flow. The GND pin must be connected to the ground plane for proper dissipation.

Applications Note:

- 1) The phase compensation circuit and ESR of the output capacitor are used inside the circuit to compensate, so a capacitor larger than 1.0uF must be connected to the ground.
- 2) It is recommended to use 1uF polar capacitors for input and output, and to keep the capacitors as close to the VIN and V_{OUT} pins of LDO as possible.
- 3) Pay attention to the use conditions of input and output voltages and load currents to avoid the power consumption (PD) inside the IC exceeding the maximum power consumption allowed by the package.

$$PD = (V_{IN} - V_{OUT}) \times I_{OUT}$$
$$T_{PN} = PD \times R_{\theta JA} + T$$

T_{PN} is junction temperature

T is ambient temperature.

- 4) When the input voltage V_{IN} is greater than 2.5V, if V_{IN} is also higher than the output set value plus the device dropout voltage, V_{OUT} is equal to the set value. Otherwise, V_{OUT} is equal to V_{IN} minus the dropout voltage. If V_{IN} lower than 2.5V, the V_{OUT} is:

$$V_{OUT} = V_{IN} - V_{Dropout}$$

PACKAGE OUTLINE DIMENSIONS

SOT23-3

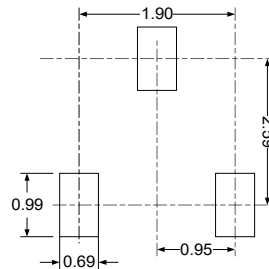
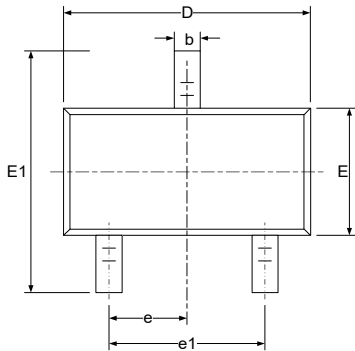
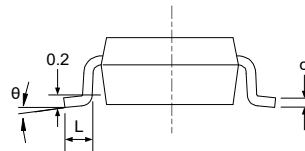
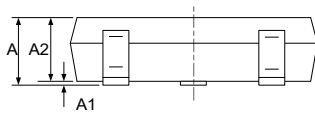

RECOMMENDED LAND PATTERN (Unit: mm)

Symbol	Dimensions In Millimeters		Dimensions In Inches	
	Min	Max	Min	Max
A	1.050	1.250	0.041	0.049
A1	0.000	0.100	0.000	0.004
A2	1.050	1.150	0.041	0.045
b	0.300	0.500	0.012	0.020
c	0.100	0.200	0.004	0.008
D	2.820	3.020	0.111	0.119
E	1.500	1.700	0.059	0.067
E1	2.650	2.950	0.104	0.116
e	0.950(BSC)		0.037(BSC)	
e1	1.800	2.000	0.071	0.079
L	0.300	0.600	0.012	0.024
θ	0°	8°	0°	8°

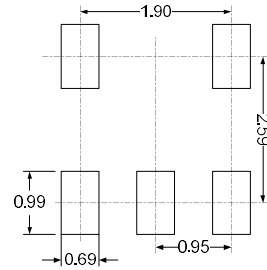
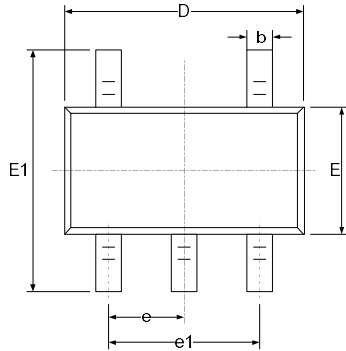
SOT23-5

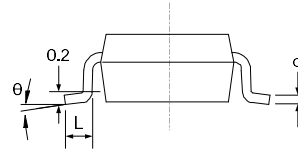
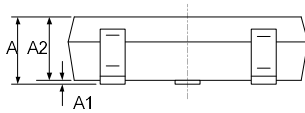

RECOMMENDED LAND PATTERN (Unit: mm)



Symbol	Dimensions In Millimeters		Dimensions In Inches	
	Min	Max	Min	Max
A	1.050	1.250	0.041	0.049
A1	0.000	0.100	0.000	0.004
A2	1.050	1.150	0.041	0.045
b	0.300	0.500	0.012	0.020
c	0.100	0.200	0.004	0.008
D	2.820	3.020	0.111	0.119
E	1.500	1.700	0.059	0.067
E1	2.650	2.950	0.104	0.116
e	0.950(BSC)		0.037(BSC)	
e1	1.800	2.000	0.071	0.079
L	0.300	0.600	0.012	0.024
θ	0°	8°	0°	8°

SOT89-3L

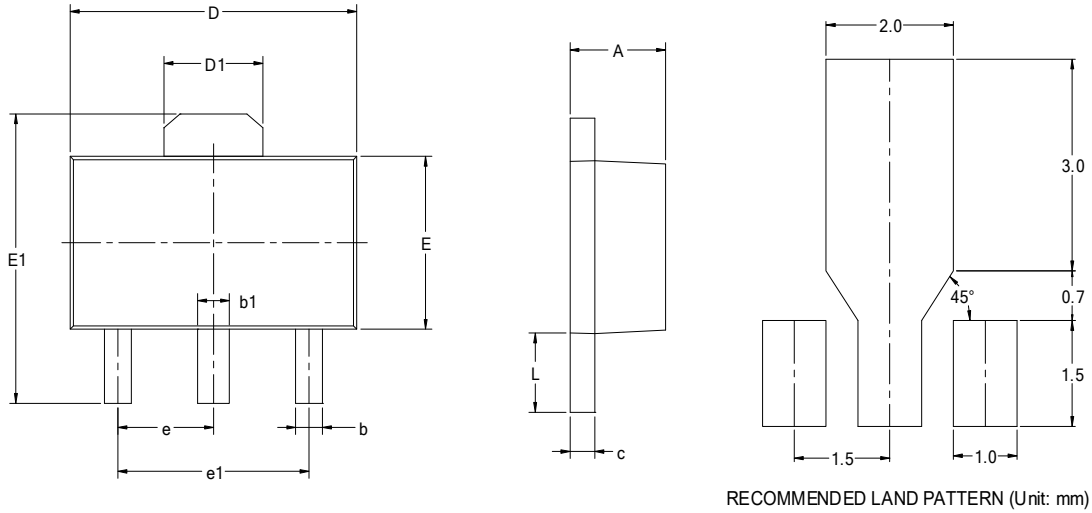

Symbol	Dimensions In Millimeters		Dimensions In Inches	
	Min	Max	Min	Max
A	1.400	1.600	0.055	0.063
b	0.320	0.520	0.013	0.020
b1	0.400	0.580	0.016	0.023
c	0.350	0.440	0.014	0.017
D	4.400	4.600	0.173	0.181
D1	1.550 REF		0.061 REF	
E	2.300	2.600	0.091	0.102
E1	3.940	4.250	0.155	0.167
e	1.500 BSC		0.060 BSC	
e1	3.000 BSC		0.118 BSC	
L	0.900	1.200	0.035	0.047

SOT223

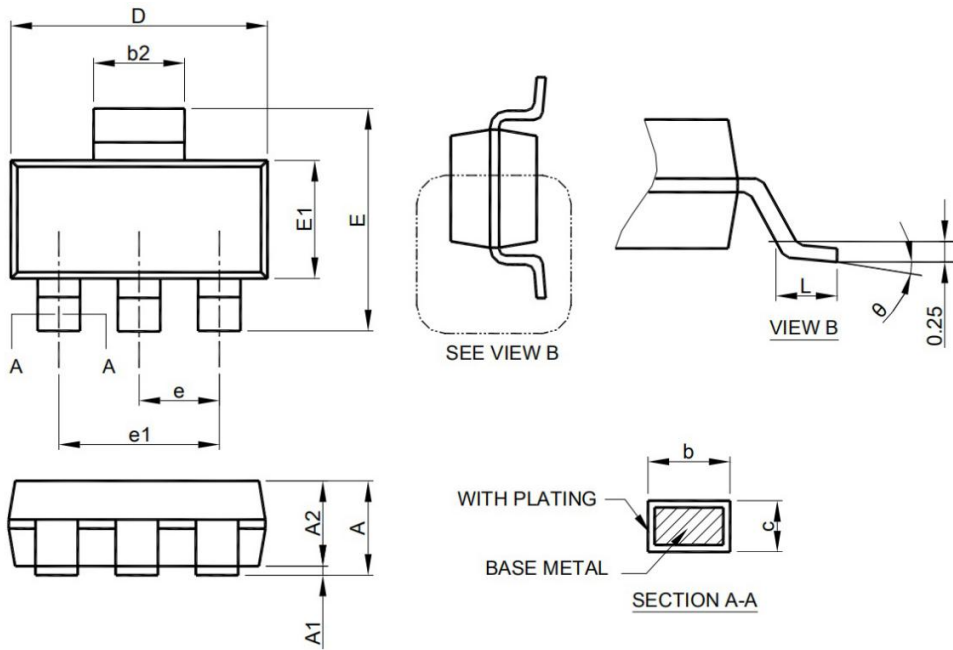

Symbol	Dimensions In Millimeters		Dimensions In Inches	
	Min	Max	Min	Max
A	-	1.800	-	0.071
A1	0.02	0.10	0.001	0.004
A2	1.55	1.65	0.061	0.065
b	0.66	0.84	0.026	0.033
b2	2.90	3.10	0.114	0.122
c	0.23	0.33	0.009	0.013
D	6.30	6.70	0.248	0.263
E	6.70	7.30	0.263	0.287
E1	3.30	3.70	0.130	0.145
e	2.30BSC		0.090	
e1	4.60BSC		0.181	
L	0.90	-	0.035	-

X-ON Electronics

Largest Supplier of Electrical and Electronic Components

Click to view similar products for [Linear Voltage Regulators](#) category:

Click to view products by [RUNIC](#) manufacturer:

Other Similar products are found below :

[LV5684PVD-XH](#) [MCDTSA6-2R](#) [L7815ACV-DG](#) [LV56801P-E](#) [UA7805CKC](#) [714954EB](#) [ZMR500QFTA](#) [BA033LBSG2-TR](#)

[NCV78M05ABDTRKG](#) [LV5680P-E](#) [L79M05T-E](#) [L78LR05D-MA-E](#) [NCV317MBTG](#) [NTE7227](#) [MP2018GZD-33-P](#) [MP2018GZD-5-P](#)

[LV5680NPVC-XH](#) [ZTS6538SE](#) [UA78L09CLP](#) [UA78L09CLPR](#) [CAT6221-PPTD-GT3](#) [MC78M09CDTRK](#) [NCV51190MNTAG](#)

[BL1118CS8TR1833](#) [BL8563CKETR18](#) [BL8077CKETR33](#) [BL9153-33CC3TR](#) [BL9161G-15BADRN](#) [BL9161G-28BADRN](#)

[BRCO7530MMC](#) [CJ7815B-TFN-ARG](#) [LM317C](#) [GM7333K](#) [GM7350K](#) [XC6206P332MR](#) [HT7533](#) [LM7912S/TR](#) [LT1764S/TR](#) [LM7805T](#)

[LM338T](#) [LM1117IMP-3.3/TR](#) [HT1117AM-3.3](#) [HT7550S](#) [AMS1117-3.3](#) [HT7150S](#) [78L12](#) [HT7550](#) [HT7533-1](#) [HXY6206I-2.5](#) [HT7133](#)