

Low Power, Low Dropout, 200mA Linear Regulators

FEATURES

- Low Dropout Voltage
- Thermal-Overload Protection
- Output Current Limit
- 10nA Logic-Controlled Shutdown
- 1 μ A Low Supply Current
- 1.7V to 7.5V Input Voltage Range
- 200mA Output Current
- -40°C to +85°C Operating Temperature Range
- Available in Green UTDFN-1x1-4, SOT23-5, SOT23-3, SOT353(SC70-5) and SOT89-3L (L-Type) Package

APPLICATIONS

- Cellular Telephones
- Camera Modules
- Modems
- HiFi Audio Radio Transceivers
- PLL/Synthesizer, Clocking
- Medium-Current, Noise-Sensitive Applications

DESCRIPTION

The RS3221 series low-power, low-dropout, CMOS LDO operate from 1.7V to 7.5V input voltage that can supply up to 200 mA of output current. Designed to meet the requirements of analog circuits, the RS3221 series device provides low noise, high PSRR, low quiescent current, and low line and load transient response.

The device is designed to work with a 1- μ F input and a 1- μ F output ceramic capacitor (no separate noise bypass capacitor required). An external noise bypass capacitor connected to the device's BP pin can further reduce the noise level.

Other features include a 10nA logic-controlled shutdown mode, foldback current limit and thermal shutdown protection.

The RS3221 series is available in Green UTDFN-1x1-4, SOT23-3, SOT23-5, SOT353(SC70-5) and SOT89-3L(L-Type) package. It operates over an ambient temperature range of -40°C to +85°C.

Functional Block Diagram

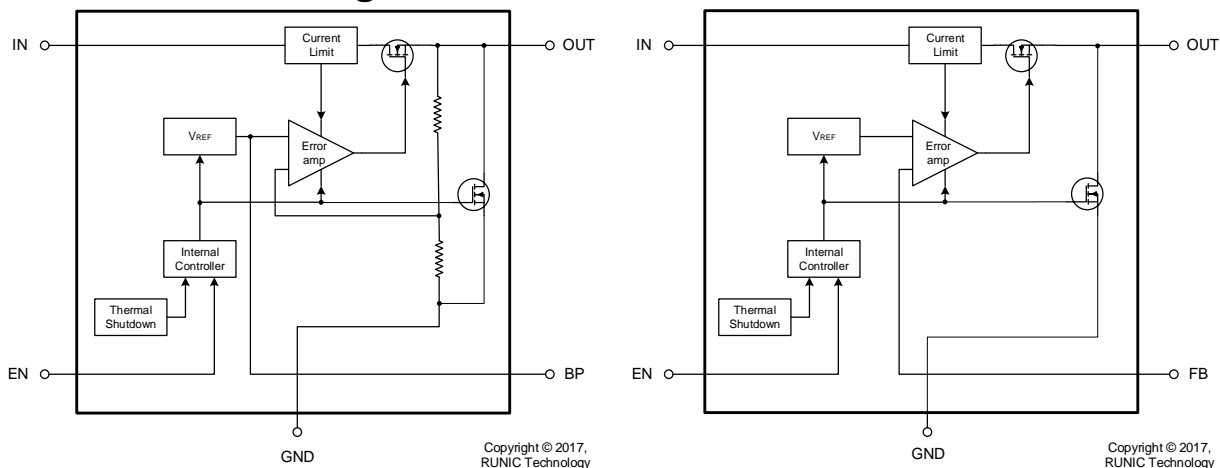

Pin Configuration and Functions (Top View)

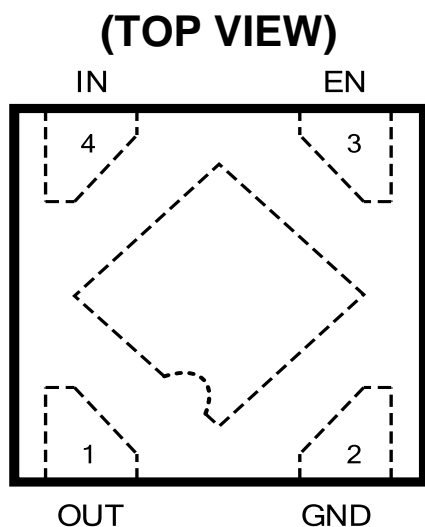
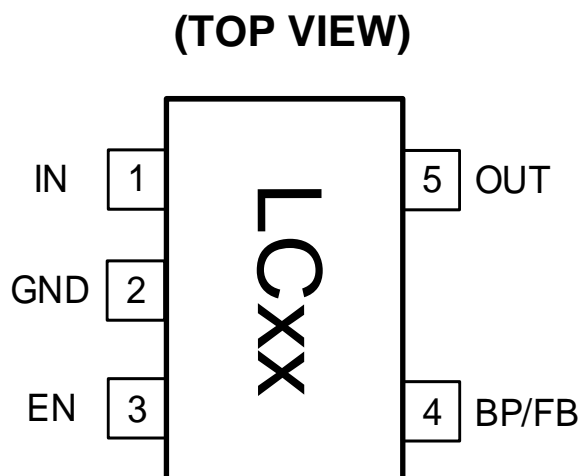
UTDFN-1x1-4

SOT23-5/SOT353(SC70-5)

UTDFN-1x1-4		I/O	DESCRIPTION
NUMBER	NAME		
1	OUT	O	Regulator Output.
2	GND	G	Ground.
3	EN	I	Enable Input. A logic low reduces the supply current to 10nA. Connect to IN for normal operation.
4	IN	I	Regulator Input. Supply voltage can range from 1.7V to 7.5V. Bypass with a 1μF capacitor to GND.
Thermal Pad	-	-	Connect the thermal pad to a large-area ground plane. This pad is not an electrical connection to the device ground.

SOT23-5 /SOT353(SC70-5)		I/O	DESCRIPTION
NUMBER	NAME		
1	IN	I	Regulator Input. Supply voltage can range from 1.7V to 7.5V. Bypass with a 1μF capacitor to GND.
2	GND	G	Ground.
3	EN	I	Enable Input. A logic low reduces the supply current to 10nA. Connect to IN for normal operation.
4	BP	O	Reference-Noise Bypass (fixed voltage version only). Bypass with a low-leakage 0.01μF ceramic capacitor for reduced noise at the output. The capacitor is recommended to be placed very close to the pin for high PSRR.
	FB		Feedback Pin (adjustable voltage version only). This is used to set the output voltage of the device.
5	OUT	O	Regulator Output.

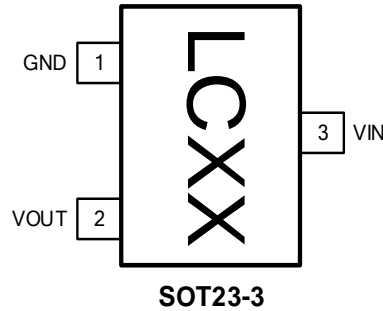
(TOP VIEW)



NOTE: XX indicate Output Voltage, xx indicate DataCode
 For example: LC33 (V_{OUT}=3.3V)

SOT23-3		I/O	DESCRIPTION
NUMBER	NAME		
1	GND	G	Ground.
2	OUT	O	Regulator Output.
3	IN	I	Regulator Input. Supply voltage can range from 1.7V to 7.5V. Bypass with a 1μF capacitor to GND.

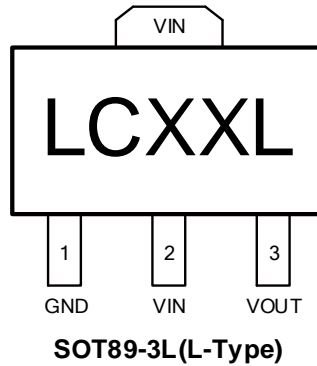

SOT89-3L(L-Type)		I/O	DESCRIPTION
NUMBER	NAME		
1	GND	G	Ground.
2	IN	I	Regulator Input. Supply voltage can range from 1.7V to 7.5V. Bypass with a 1μF capacitor to GND.
3	OUT	O	Regulator Output.

PACKAGE/ORDERING INFORMATION

MODEL	VOUT (V)	PIN-PACKAGE	ORDERING NUMBER	PACKAGE MARKING	PACKAGE OPTION
RS3221-0.8	0.8V	UTDFN-1x1-4	RS3221-0.8YUTDN4	CA	Tape and Reel, 10000
RS3221-1.0	1.0V	UTDFN-1x1-4	RS3221-1.0YUTDN4	CB	Tape and Reel, 10000
RS3221-1.2	1.2V	UTDFN-1x1-4	RS3221-1.2YUTDN4	CC	Tape and Reel, 10000
RS3221-1.5	1.5V	UTDFN-1x1-4	RS3221-1.5YUTDN4	CD	Tape and Reel, 10000
RS3221-1.8	1.8V	UTDFN-1x1-4	RS3221-1.8YUTDN4	CE	Tape and Reel, 10000
RS3221-2.05	2.05V	UTDFN-1x1-4	RS3221-2.05YUTDN4	CF	Tape and Reel, 10000
RS3221-2.5	2.5V	UTDFN-1x1-4	RS3221-2.5YUTDN4	CG	Tape and Reel, 10000
RS3221-2.8	2.8V	UTDFN-1x1-4	RS3221-2.8YUTDN4	CH	Tape and Reel, 10000
RS3221-3.0	3.0V	UTDFN-1x1-4	RS3221-3.0YUTDN4	CI	Tape and Reel, 10000
RS3221-3.3	3.3V	UTDFN-1x1-4	RS3221-3.3YUTDN4	CJ	Tape and Reel, 10000
RS3221-3.6	3.6V	UTDFN-1x1-4	RS3221-3.6YUTDN4	CK	Tape and Reel, 10000
RS3221-4.0	4.0V	UTDFN-1x1-4	RS3221-4.0YUTDN4	CL	Tape and Reel, 10000
RS3221-5.0	5.0V	UTDFN-1x1-4	RS3221-5.0YUTDN4	CM	Tape and Reel, 10000
RS3221-0.8	0.8V	SOT23-5	RS3221-0.8YF5	LC08	Tape and Reel, 3000
RS3221-1.0	1.0V	SOT23-5	RS3221-1.0YF5	LC10	Tape and Reel, 3000
RS3221-1.2	1.2V	SOT23-5	RS3221-1.2YF5	LC12	Tape and Reel, 3000
RS3221-1.5	1.5V	SOT23-5	RS3221-1.5YF5	LC15	Tape and Reel, 3000
RS3221-1.8	1.8V	SOT23-5	RS3221-1.8YF5	LC18	Tape and Reel, 3000
RS3221-2.05	2.05V	SOT23-5	RS3221-2.05YF5	LC205	Tape and Reel, 3000
RS3221-2.5	2.5V	SOT23-5	RS3221-2.5YF5	LC25	Tape and Reel, 3000
RS3221-2.8	2.8V	SOT23-5	RS3221-2.8YF5	LC28	Tape and Reel, 3000
RS3221-3.0	3.0V	SOT23-5	RS3221-3.0YF5	LC30	Tape and Reel, 3000
RS3221-3.3	3.3V	SOT23-5	RS3221-3.3YF5	LC33	Tape and Reel, 3000
RS3221-3.6	3.6V	SOT23-5	RS3221-3.6YF5	LC36	Tape and Reel, 3000
RS3221-4.0	4.0V	SOT23-5	RS3221-4.0YF5	LC40	Tape and Reel, 3000
RS3221-5.0	5.0V	SOT23-5	RS3221-5.0YF5	LC50	Tape and Reel, 3000
RS3221-0.8	0.8V	SOT353(SC70-5)	RS3221-0.8YC5	LC08	Tape and Reel, 3000
RS3221-1.0	1.0V	SOT353(SC70-5)	RS3221-1.0YC5	LC10	Tape and Reel, 3000
RS3221-1.2	1.2V	SOT353(SC70-5)	RS3221-1.2YC5	LC12	Tape and Reel, 3000
RS3221-1.5	1.5V	SOT353(SC70-5)	RS3221-1.5YC5	LC15	Tape and Reel, 3000
RS3221-1.8	1.8V	SOT353(SC70-5)	RS3221-1.8YC5	LC18	Tape and Reel, 3000
RS3221-2.05	2.05V	SOT353(SC70-5)	RS3221-2.05YC5	LC205	Tape and Reel, 3000
RS3221-2.5	2.5V	SOT353(SC70-5)	RS3221-2.5YC5	LC25	Tape and Reel, 3000
RS3221-2.8	2.8V	SOT353(SC70-5)	RS3221-2.8YC5	LC28	Tape and Reel, 3000
RS3221-3.0	3.0V	SOT353(SC70-5)	RS3221-3.0YC5	LC30	Tape and Reel, 3000
RS3221-3.3	3.3V	SOT353(SC70-5)	RS3221-3.3YC5	LC33	Tape and Reel, 3000
RS3221-3.6	3.6V	SOT353(SC70-5)	RS3221-3.6YC5	LC36	Tape and Reel, 3000
RS3221-4.0	4.0V	SOT353(SC70-5)	RS3221-4.0YC5	LC40	Tape and Reel, 3000
RS3221-5.0	5.0V	SOT353(SC70-5)	RS3221-5.0YC5	LC50	Tape and Reel, 3000

MODEL	VOUT (V)	PIN-PACKAGE	ORDERING NUMBER	PACKAGE MARKING	PACKAGE OPTION
RS3221-1.35	1.35V	UTDFN-1x1-4	RS3221-1.35YUTDN4	CN	Tape and Reel, 10000
RS3221-1.85	1.85V	UTDFN-1x1-4	RS3221-1.85YUTDN4	CO	Tape and Reel, 10000
RS3221-3.3	3.3V	UTDFN-1x1-4	RS3221-3.3AYUTDN4	CJ	Tape and Reel, 10000
RS3221-2.7	2.7V	SOT23-5	RS3221-2.7YF5	LC27	Tape and Reel, 3000
RS3221-2.85	2.85V	SOT23-5	RS3221-2.85YF5	LC285	Tape and Reel, 3000
RS3221-0.8	0.8V	SOT23-3	RS3221-0.8YF3	LC08	Tape and Reel, 3000
RS3221-1.0	1.0V	SOT23-3	RS3221-1.0YF3	LC10	Tape and Reel, 3000
RS3221-1.2	1.2V	SOT23-3	RS3221-1.2YF3	LC12	Tape and Reel, 3000
RS3221-1.5	1.5V	SOT23-3	RS3221-1.5YF3	LC15	Tape and Reel, 3000
RS3221-1.8	1.8V	SOT23-3	RS3221-1.8YF3	LC18	Tape and Reel, 3000
RS3221-2.05	2.05V	SOT23-3	RS3221-2.05YF3	LC205	Tape and Reel, 3000
RS3221-2.5	2.5V	SOT23-3	RS3221-2.5YF3	LC25	Tape and Reel, 3000
RS3221-2.8	2.8V	SOT23-3	RS3221-2.8YF3	LC28	Tape and Reel, 3000
RS3221-3.0	3.0V	SOT23-3	RS3221-3.0YF3	LC30	Tape and Reel, 3000
RS3221-3.3	3.3V	SOT23-3	RS3221-3.3YF3	LC33	Tape and Reel, 3000
RS3221-3.6	3.6V	SOT23-3	RS3221-3.6YF3	LC36	Tape and Reel, 3000
RS3221-4.0	4.0V	SOT23-3	RS3221-4.0YF3	LC40	Tape and Reel, 3000
RS3221-5.0	5.0V	SOT23-3	RS3221-5.0YF3	LC50	Tape and Reel, 3000
RS3221-1.8	1.8V	SOT89-3L(L-Type)	RS3221-1.8YE3L	LC18L	Tape and Reel, 1000
RS3221-2.5	2.5V	SOT89-3L(L-Type)	RS3221-2.5YE3L	LC25L	Tape and Reel, 1000
RS3221-3.3	3.3V	SOT89-3L(L-Type)	RS3221-3.3YE3L	LC33L	Tape and Reel, 1000

MODEL	V _{FB} (V)	PIN-PACKAGE	ORDERING NUMBER	PACKAGE MARKING	PACKAGE OPTION
RS3221-ADJ8	0.81	SOT23-5	RS3221-ADJ8YF5	LCAD8	Tape and Reel, 3000
		SOT353(SC70-5)	RS3221-ADJ8YC5	LCAD8	Tape and Reel, 3000
RS3221-ADJC	1.21	SOT23-5	RS3221-ADJCYF5	LCADC	Tape and Reel, 3000
		SOT353(SC70-5)	RS3221-ADJCYC5	LCADC	Tape and Reel, 3000

Absolute Maximum Ratings

over operating free-air temperature range (unless otherwise noted) ⁽¹⁾⁽²⁾

		MIN	MAX	UNIT
V _{IN}	Input voltage	-0.3	8	V
V _{EN}	Enable input voltage	-0.3	V _{IN}	V
T _J	Junction temperature		150	°C
P _D	Continuous power dissipation ⁽³⁾	Internally Limited		W
T _{stg}	Storage temperature	-65	150	°C

- (1) Stresses beyond those listed under *Absolute Maximum Ratings* may cause permanent damage to the device. These are stress ratings only, and functional operation of the device at these or any other conditions beyond those indicated under *Recommended Operating Conditions* is not implied. Exposure to absolute-maximum-rated conditions for extended periods may affect device reliability.
- (2) All voltages are with respect to the GND pin.
- (3) Internal thermal shutdown circuitry protects the device from permanent damage.

ESD Ratings

		VALUE	UNIT	
V _(ESD)	Electrostatic discharge	Human-body model (HBM)	±6000	V
		Machine model (MM)	±400	V

Recommended Operating Conditions

over operating free-air temperature range (unless otherwise noted) ⁽¹⁾

		MIN	MAX	UNIT
V _{IN}	Input supply voltage	1.7	7.5	V
V _{EN}	Enable input voltage	0	V _{IN}	V
I _{OUT}	Output current	0	300	mA
T _A	Operating temperature	-40	+85	°C

- (1) All voltages are with respect to the GND pin.

Thermal Information

THERMAL METRIC ⁽¹⁾		RS3221	RS3221	RS3221	RS3221	RS3221	UNIT
		UTDFN-1x1-4	SOT353 (SC70-5)	SOT23-5	SOT23-3	SOT89-3L (L-Type)	
		4 PINS	5 PINS	5 PINS	3 PINS	3 PINS	
R _{θJA}	Junction-to-ambient thermal resistance	312.5	312.5	250	312.5	208.3	°C/W
R _{θJC(top)}	Junction-to-case (top) thermal resistance	137.9	141.8	84.3	134.3	88.5	°C/W
R _{θJB}	Junction-to-board thermal resistance	83.5	84.5	39.5	84.5	39.6	°C/W
ψ _{JT}	Junction-to-top characterization parameter	5.3	3.9	2.86	4.8	26.5	°C/W
ψ _{JB}	Junction-to-board characterization parameter	83.8	82.1	58.5	81.5	49.7	°C/W
R _{JC(bot)}	Junction-to-case (bottom) thermal resistance	71.8	N/A	N/A	N/A	77.7	°C/W
P _d	Power Dissipation	0.4	0.4	0.5	0.4	0.6	

ELECTRICAL CHARACTERISTICS

 ($V_{IN} = V_{OUT(NOMINAL)} + 0.5V^{(1)}$, Full = $-40^{\circ}C$ to $+85^{\circ}C$, unless otherwise noted.)

PARAMETER	SYMBOL	CONDITIONS	TEMP	MIN	TYP	MAX	UNITS
Input Voltage	V_{IN}		$+25^{\circ}C$	1.7 ⁽¹⁾		7.5	V
Output Voltage Accuracy ⁽¹⁾		$I_{OUT} = 0.1mA$	$+25^{\circ}C$	-2.5		2.5	%
		$I_{OUT} = 0.1mA$, RS3221-3.3AYUTDN4	$+25^{\circ}C$	-1		1	%
Feedback Voltage	V_{FB}	$I_{OUT} = 0.1mA$, RS3221-ADJ8	$+25^{\circ}C$	0.79	0.81	0.83	V
		$I_{OUT} = 0.1mA$, RS3221-ADJC	$+25^{\circ}C$	1.18	1.21	1.24	V
Maximum Output Current ⁽¹⁾			$+25^{\circ}C$	200			mA
Current Limit ⁽¹⁾	I_{LIM}		$+25^{\circ}C$		300		mA
Ground Pin Current	I_Q	No load	$+25^{\circ}C$		1.0		μA
Dropout Voltage ⁽²⁾	V_{DROP}	$I_{OUT} = 200mA$	$+25^{\circ}C$	$V_{OUT}=1.2V$		900	mV
				$V_{OUT}=1.5V$		630	
				$V_{OUT}=3.3V$		160	
Line Regulation ⁽¹⁾	ΔV_{LNR}	$V_{IN} = (V_{OUT} + 0.5V)$ to 7.5V, $I_{OUT} = 1mA$	$+25^{\circ}C$		0.1	0.2	%/V
Load Regulation	ΔV_{OUT}	$I_{OUT} = 0.1mA$ to 200mA, $C_{OUT} = 1\mu F$	$+25^{\circ}C$		15	30	mV
		$I_{OUT} = 0.1mA$ to 200mA, $C_{OUT} = 1\mu F$, RS3221-ADJ	$+25^{\circ}C$		0.5	10	mV
Output Voltage Noise	e_n	$f = 10Hz$ to 100kHz, $C_{BP} = 0.01\mu F$, $C_{OUT} = 10\mu F$, $I_{OUT}=30mA$	$+25^{\circ}C$		NA		μV_{RMS}
Output Voltage Temperature Coefficient	$\frac{\Delta V_{OUT}}{\Delta T_A \times V_{OUT}}$	$I_{LOAD} = 0.1mA$	FULL		65		ppm/ $^{\circ}C$
Power Supply Rejection Ratio	PSRR	$C_{BP} = 0\mu F$, $I_{LOAD} = 30mA$, $C_{OUT} = 1\mu F$, $V_{IN} = V_{OUT}+1V$ $\Delta V_{RIPPLE}=0.2V_{P-P}$	$f = 217Hz$	$+25^{\circ}C$		46	dB
			$f = 1kHz$			34	
		$C_{BP} = 10nF$, $I_{LOAD} = 30mA$, $C_{OUT} = 1\mu F$, $V_{IN} = V_{OUT}+1V$ $\Delta V_{RIPPLE}=0.2V_{P-P}$	$f = 217Hz$	$+25^{\circ}C$		48	dB
			$f = 1kHz$			36	

SHUTDOWN

EN Input Threshold	V_{IH}	$V_{IN} = 1.7V$	Full	1.4			V
	V_{IL}		Full			0.4	
EN Input Threshold	V_{IH}	$V_{IN} = 7.5V$	Full	2.3			V
	V_{IL}		Full			0.8	
EN Input Bias Current	I_{BH}	EN = 7.5V	$+25^{\circ}C$		0.01	1	μA
	I_{BL}	EN = 0V	Full		0.01		
Shutdown Supply Current	$I_{Q(SHDN)}$	EN = 0V	Full		0.01	1	μA
Start-Up Time ⁽⁴⁾	t_{STR}	$C_{OUT} = 1\mu F$, No Load	$+25^{\circ}C$		180		μs
R_{ON} of Discharge MOSFET		$V_{IN} = 4.0V$, $V_{EN} = 0V$	$+25^{\circ}C$		25		Ω

THERMAL PROTECTION

Thermal Shutdown Temperature	T_{SHDN}				140		$^{\circ}C$
------------------------------	------------	--	--	--	-----	--	-------------

NOTES:

1. $V_{IN} = V_{OUT}(\text{NOMINAL}) + 0.5V$ or $1.7V$, whichever is greater.
2. The dropout voltage is defined as $V_{IN} - V_{OUT}$, when V_{OUT} is $100mV$ below the value of V_{OUT} for $V_{IN} = V_{OUT} + 0.5V$.
3. Time needed for V_{OUT} to reach 90% of final value.

TYPICAL APPLICATION CIRCUIT

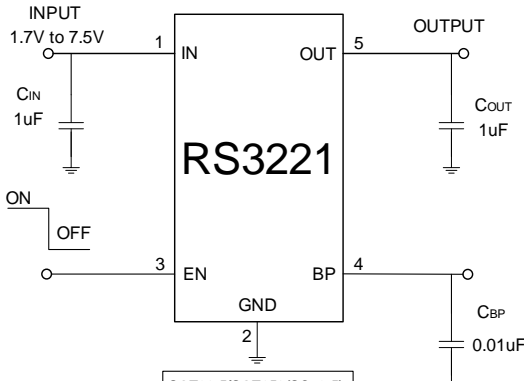
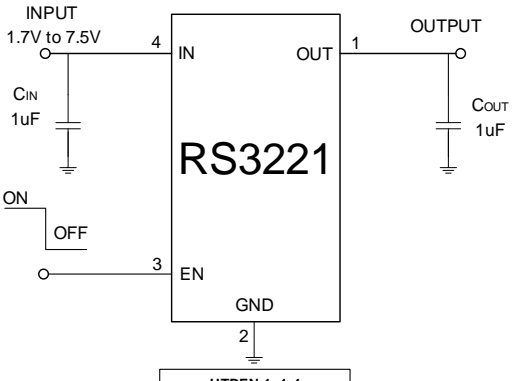
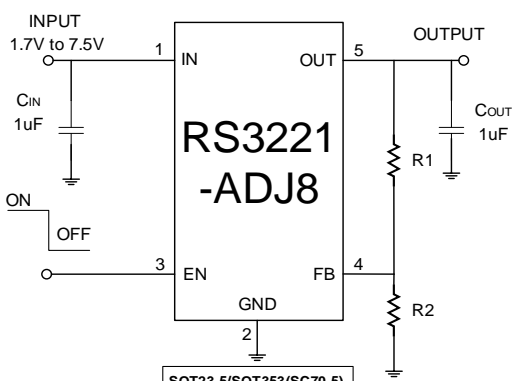
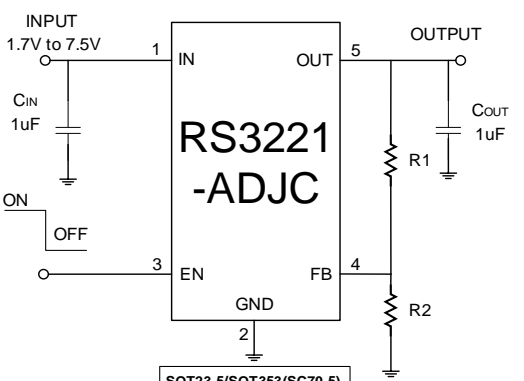
<p style="text-align: center;">Typical Circuit</p>  <p style="text-align: center;">RS3221</p> <p style="text-align: center;">SOT23-5/SOT353(SC70-5)</p>	<p style="text-align: center;">Typical Circuit</p>  <p style="text-align: center;">RS3221</p> <p style="text-align: center;">UTDFN-1x1-4</p>
<p style="text-align: center;">Typical Circuit</p>  <p style="text-align: center;">RS3221-ADJ8</p> <p style="text-align: center;">SOT23-5/SOT353(SC70-5)</p>	<p style="text-align: center;">Typical Circuit</p>  <p style="text-align: center;">RS3221-ADJC</p> <p style="text-align: center;">SOT23-5/SOT353(SC70-5)</p>
<p>NOTE: Choose $R_2 = 160k\Omega$ to maintain a $5\mu A$ minimum load. Calculate the value for R_1 using the following equation:</p> $R_1 = R_2 * \left(\frac{V_{OUT}}{0.81} - 1 \right)$	<p>NOTE: Choose $R_2 = 240k\Omega$ to maintain a $5\mu A$ minimum load. Calculate the value for R_1 using the following equation:</p> $R_1 = R_2 * \left(\frac{V_{OUT}}{1.21} - 1 \right)$

TYPICAL PERFORMANCE CHARACTERISTICS

$V_{IN} = V_{OUT (NOMINAL)} + 0.5V$, $C_{IN} = 1\mu F$, $C_{OUT} = 1\mu F$, $C_{BP} = 0\mu F$, $T_A = +25^\circ C$, unless otherwise noted.

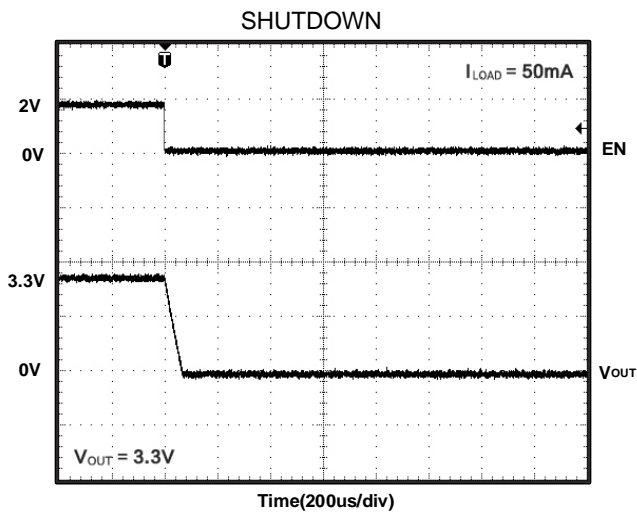
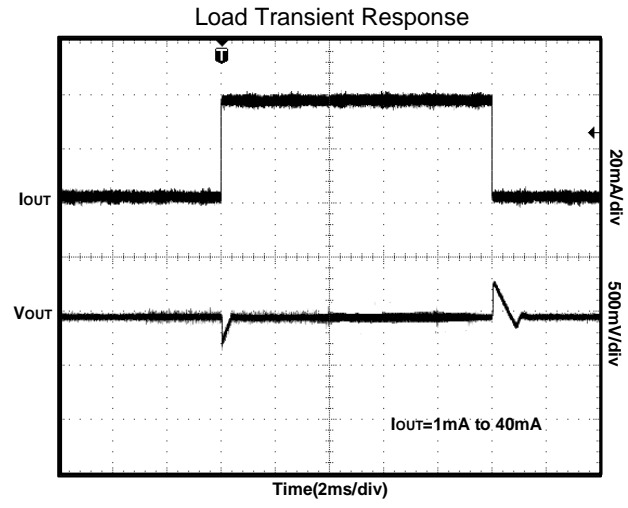
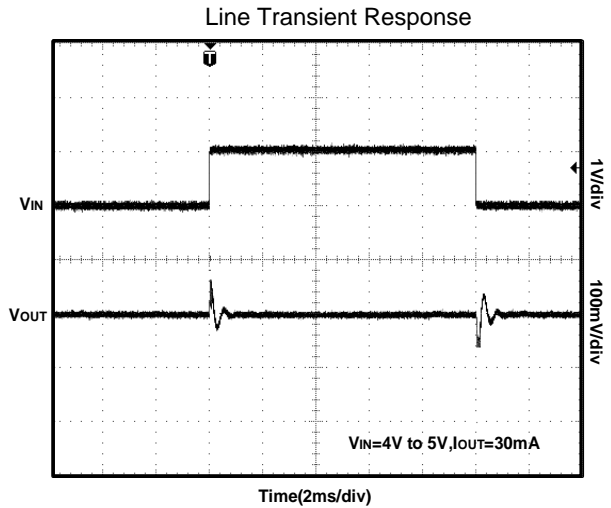
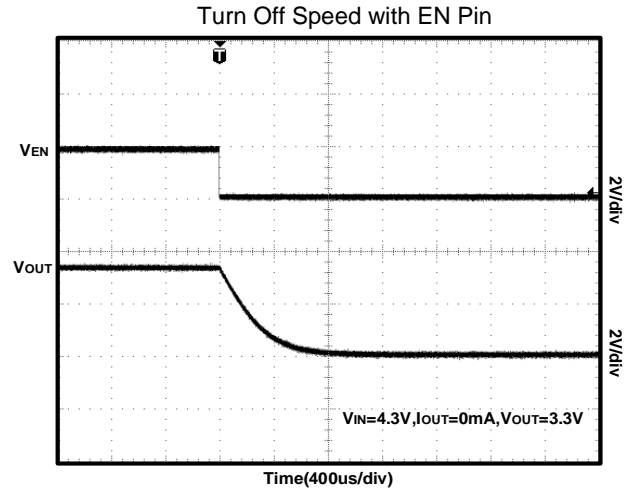
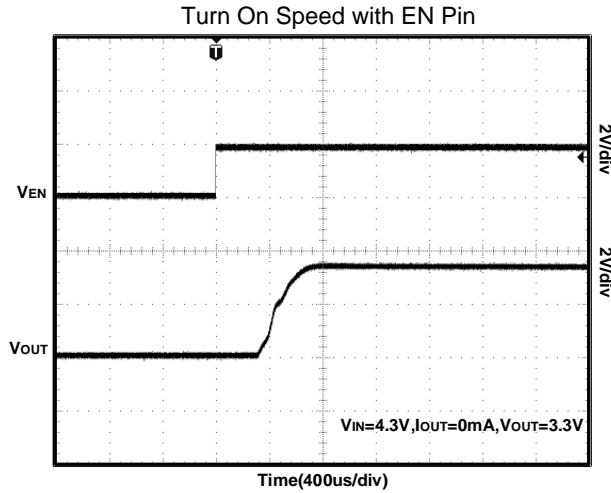

TYPICAL PERFORMANCE CHARACTERISTICS

$V_{IN} = V_{OUT (NOMINAL)} + 0.5V$, $C_{IN} = 1\mu F$, $C_{OUT} = 1\mu F$, $C_{BP} = 0\mu F$, $T_A = +25^\circ C$, unless otherwise noted.

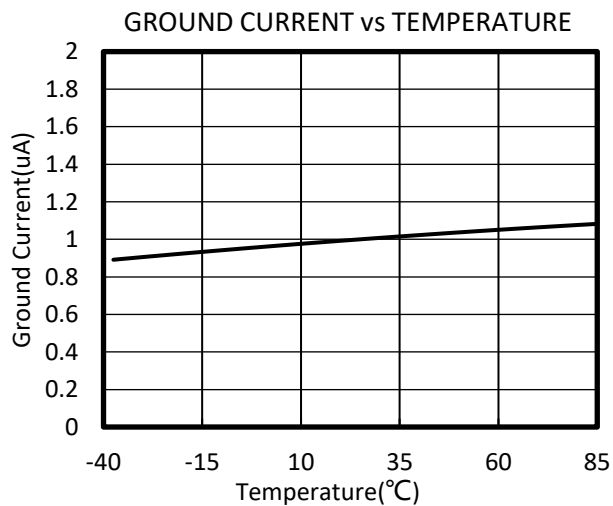
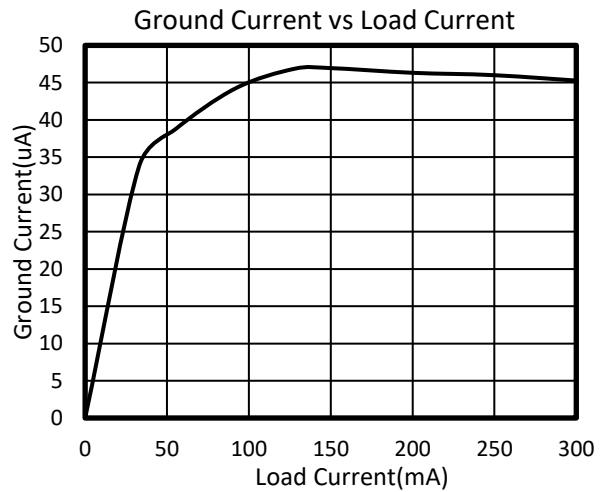
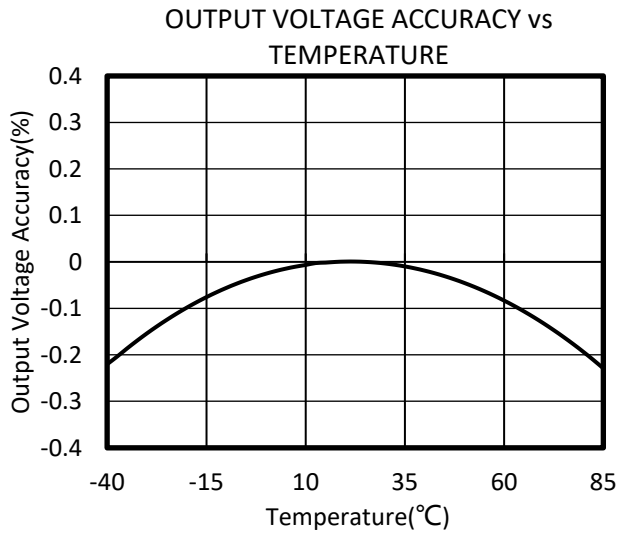
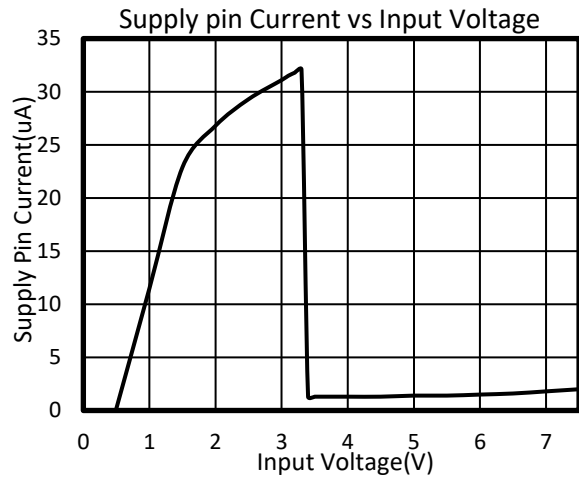
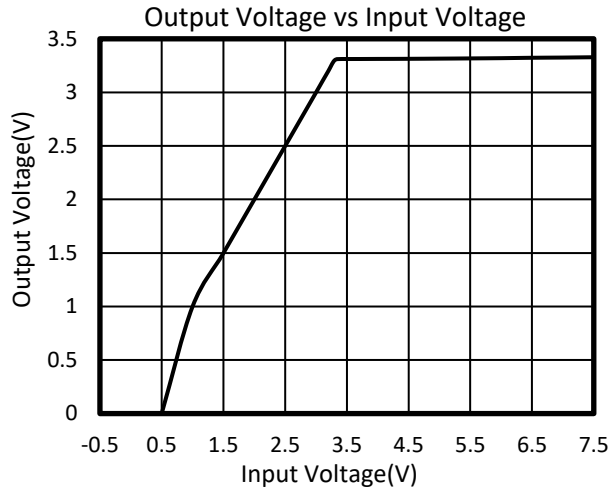

PACKAGE OUTLINE DIMENSIONS

SOT23-3

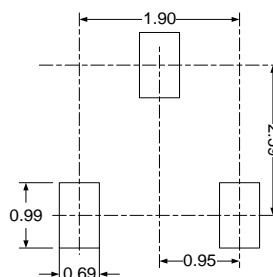
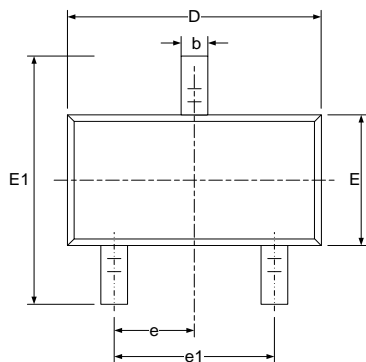
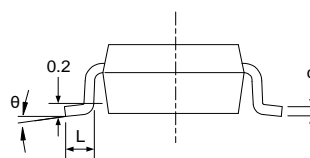
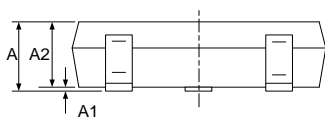
RECOMMENDED LAND PATTERN (Unit: mm)

Symbol	Dimensions In Millimeters		Dimensions In Inches	
	Min	Max	Min	Max
A	1.050	1.250	0.041	0.049
A1	0.000	0.100	0.000	0.004
A2	1.050	1.150	0.041	0.045
b	0.300	0.500	0.012	0.020
c	0.100	0.200	0.004	0.008
D	2.820	3.020	0.111	0.119
E	1.500	1.700	0.059	0.067
E1	2.650	2.950	0.104	0.116
e	0.950(BSC)		0.037(BSC)	
e1	1.800	2.000	0.071	0.079
L	0.300	0.600	0.012	0.024
θ	0°	8°	0°	8°

SOT23-5

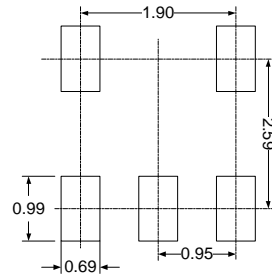
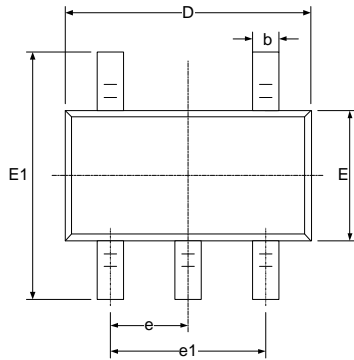
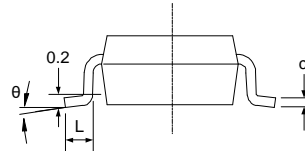
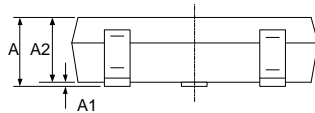
RECOMMENDED LAND PATTERN (Unit: mm)

Symbol	Dimensions In Millimeters		Dimensions In Inches	
	Min	Max	Min	Max
A	1.050	1.250	0.041	0.049
A1	0.000	0.100	0.000	0.004
A2	1.050	1.150	0.041	0.045
b	0.300	0.500	0.012	0.020
c	0.100	0.200	0.004	0.008
D	2.820	3.020	0.111	0.119
E	1.500	1.700	0.059	0.067
E1	2.650	2.950	0.104	0.116
e	0.950(BSC)		0.037(BSC)	
e1	1.800	2.000	0.071	0.079
L	0.300	0.600	0.012	0.024
θ	0°	8°	0°	8°

SOT353(SC70-5)

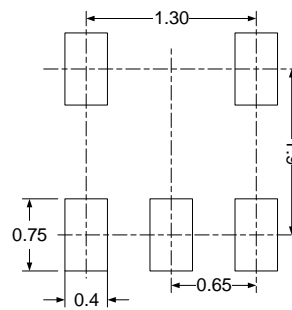
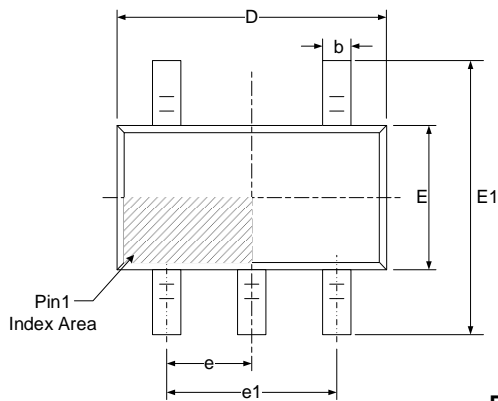
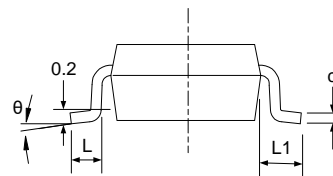
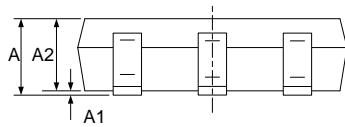

RECOMMENDED LAND PATTERN (Unit: mm)

Symbol	Dimensions In Millimeters		Dimensions In Inches	
	Min	Max	Min	Max
A	0.900	1.100	0.035	0.043
A1	0.000	0.100	0.000	0.004
A2	0.900	1.000	0.035	0.039
b	0.150	0.350	0.006	0.014
c	0.080	0.150	0.003	0.006
D	2.000	2.200	0.079	0.087
E	1.150	1.350	0.045	0.053
E1	2.150	2.450	0.085	0.096
e	0.650(BSC)		0.026(BSC)	
e1	1.300(BSC)		0.051(BSC)	
L	0.260	0.460	0.010	0.018
L1	0.525		0.021	
θ	0°	8°	0°	8°

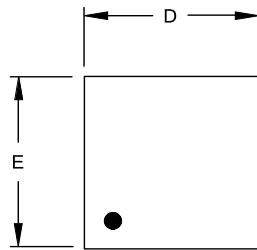
UTDFN-1x1-4

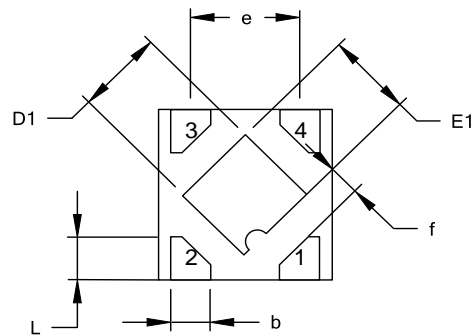

TOP VIEW



BOTTOM VIEW

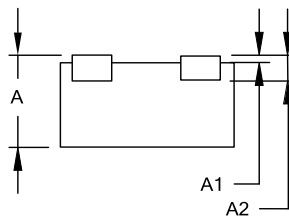

SIDE VIEW

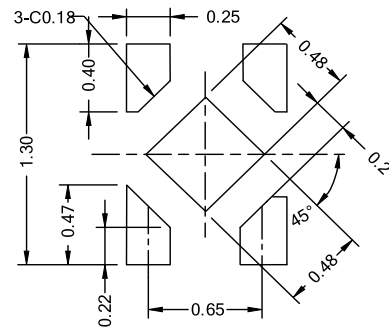

RECOMMENDED LAND PATTERN (Unit: mm)

Symbol	Dimensions In Millimeters		
	MIN	MOD	MAX
A	0.340	0.370	0.400
A1	0.000	0.020	0.050
A2	0.100REF		
D	0.950	1.000	1.050
D1	0.430	0.480	0.530
E	0.950	1.000	1.050
E1	0.430	0.480	0.530
b	0.170	0.220	0.270
e	0.600	0.650	0.700
f	0.195REF		
L	0.200	0.250	0.300

SOT89-3L

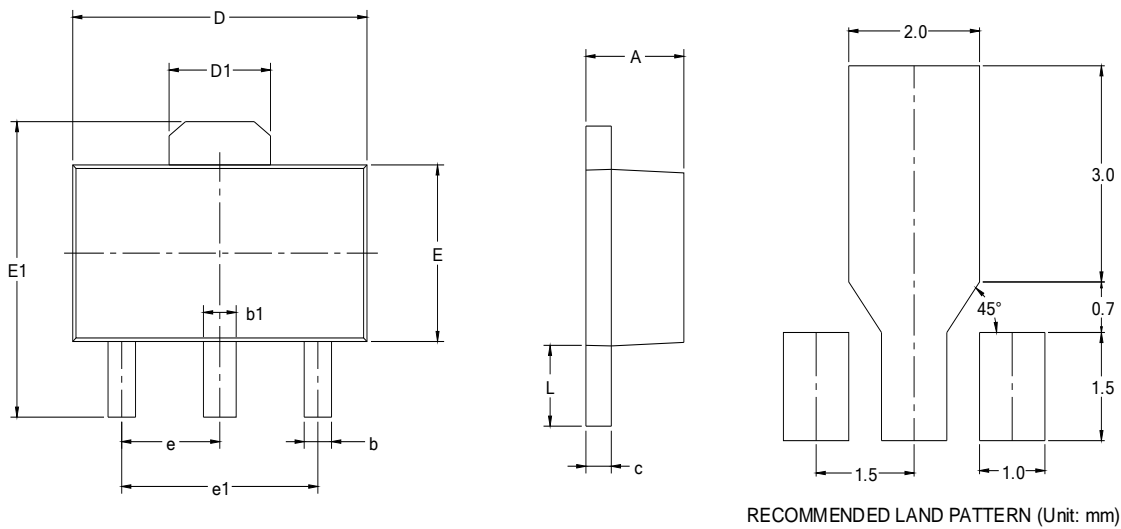

Symbol	Dimensions In Millimeters		Dimensions In Inches	
	Min	Max	Min	Max
A	1.400	1.600	0.055	0.063
b	0.320	0.520	0.013	0.020
b1	0.400	0.580	0.016	0.023
c	0.350	0.440	0.014	0.017
D	4.400	4.600	0.173	0.181
D1	1.550 REF		0.061 REF	
E	2.300	2.600	0.091	0.102
E1	3.940	4.250	0.155	0.167
e	1.500 BSC		0.060 BSC	
e1	3.000 BSC		0.118 BSC	
L	0.900	1.200	0.035	0.047

X-ON Electronics

Largest Supplier of Electrical and Electronic Components

Click to view similar products for [Linear Voltage Regulators](#) category:

Click to view products by [RUNIC](#) manufacturer:

Other Similar products are found below :

[LV5684PVD-XH](#) [MCDTSA6-2R](#) [L7815ACV-DG](#) [714954EB](#) [ZMR500QFTA](#) [BA033LBSG2-TR](#) [LV5680P-E](#) [L79M05T-E](#) [L78LR05D-MA-E](#) [NCV317MBTG](#) [NTE7227](#) [MP2018GZD-33-P](#) [MP2018GZD-5-P](#) [LV5680NPVC-XH](#) [LT1054CN8](#) [ZTS6538SE](#) [UA78L09CLP](#) [UA78L09CLPR](#) [CAT6221-PPTD-GT3](#) [MC78M09CDTRK](#) [NCV51190MNTAG](#) [78M05](#) [HT7150-1](#) [UM1540DB-18](#) [XC6234H281VR-G](#) [WL2834CA-6/TR](#) [TPL730F33-5TR](#) [TLS850F1TA](#) [V50](#) [TPS549B22RVFR](#) [UM1540DB-33](#) [WL9200P3-50B](#) [WL9100P3-33B](#) [WL9005D4-33](#) [XC6219B152MR](#) [WL2855K33-3/TR](#) [PJ54BM33SE](#) [PJ9500M25SA](#) [MD7218E33PC1](#) [H7533-2PR](#) [SK7812AU](#) [SD1A30](#) [78L33](#) [TP78L33T3](#) [L78L33ACUTR](#) [SK6513ST3A-50](#) [SK6054D4-09](#) [SK6054D4-18](#) [SK6054D4-11](#) [SK6054D4-10](#) [LM79L12F](#)