



RS331, RS393, RS339

# General-Purpose Low-Voltage Open-Drain Output Comparator

## FEATURES

- **Supply Range: +1.8V to +5.5V**
- **Low Supply Current**  
50 $\mu$ A (TYP) per channel at  $V_s = 5V$
- **Input Common-Mode Voltage Range Includes Ground**
- **Low Output Saturation Voltage 150mV Typical**
- **Open-Drain Output for Maximum Flexibility**
- **SPECIFIED UP TO +85°C**
- **Micro SIZE PACKAGES: SOT23-5**

## APPLICATIONS

- **Hysteresis Comparators**
- **Oscillators**
- **Window Comparators**
- **Industrial Equipment**
- **Test and Measurement**

## DESCRIPTION

The RS331 and RS393 is the single and dual comparator version, the RS339 is quad comparator version, and both are open-drain output comparators for maximum flexibility. It can operate from 1.8V to 5.5V, and have low power consuming 50 $\mu$ A (TYP) per channel.

The RS331, RS393 and RS339 are the most cost-effective solutions for applications where low voltage operation, low power and space saving are the primary specifications in circuit design for portable consumer products.

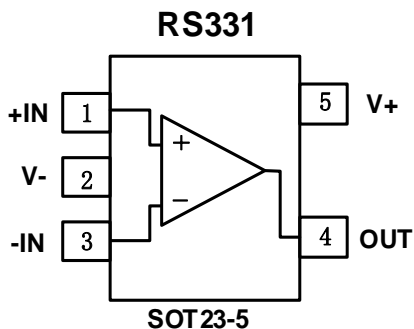
The RS331, RS393 and RS339 are available in Green SOT23-5, SOIC-8, SOIC-14 and TSSOP-14 packages. It operates over an ambient temperature range of -40°C to +85°C.

Device Information (1)

PART NUMBER	PACKAGE	BODY SIZE (NOM)
RS331	SOT23-5	1.60mm $\times$ 2.92mm
RS393	SOIC-8	4.90mm $\times$ 3.90mm
RS339	SOIC-14	8.65mm $\times$ 3.90mm
	TSSOP-14	5.00mm $\times$ 4.40mm

(1) For all available packages, see the orderable addendum at the end of the data sheet.

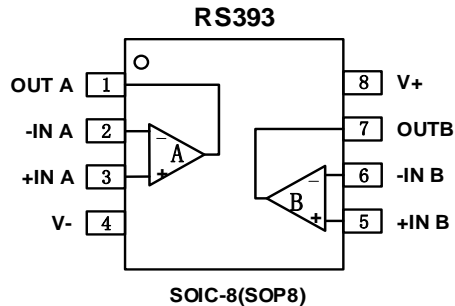
## Pin Configuration and Functions (Top View)



### Pin Description

NAME	PIN	I/O <sup>(1)</sup>	DESCRIPTION
	SOT23-5		
+IN	1	I	Noninverting input
V-	2	P	Negative (lowest) power supply
-IN	3	I	Inverting input
OUT	4	O	Output
V+	5	P	Positive (highest) power supply

(1)I=Input, O=Output, P=Power

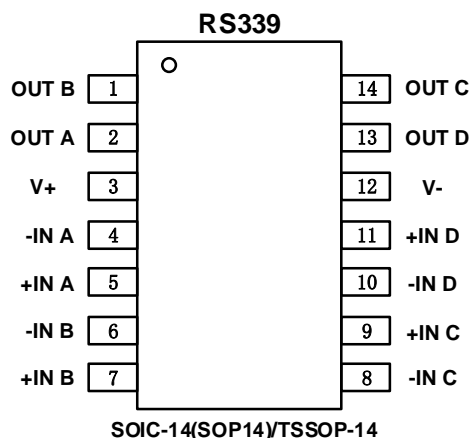


### Pin Description

NAME	PIN	I/O <sup>(1)</sup>	DESCRIPTION
	SOIC-8(SOP8)		
OUTA	1	O	Output, channel A
-INA	2	I	Inverting input, channel A
+INA	3	I	Noninverting input, channel A
V-	4	P	Negative (lowest) power supply
+INB	5	I	Noninverting input, channel B
-INB	6	I	Inverting input, channel B
OUTB	7	O	Output, channel B
V+	8	P	Positive (highest) power supply

(1)I=Input, O=Output, P=Power

## Pin Configuration and Functions (Top View)



### Pin Description

NAME	PIN	I/O <sup>(1)</sup>	DESCRIPTION
	SOIC-14(SOP14)/TSSOP-14		
OUTB	1	O	Output, channel B
OUTA	2	O	Output, channel A
V+	3	P	Positive (highest) power supply
-INA	4	I	Inverting input, channel A
+INA	5	I	Noninverting input, channel A
-INB	6	I	Inverting input, channel B
+INB	7	I	Noninverting input, channel B
-INC	8	I	Inverting input, channel C
+INC	9	I	Noninverting input, channel C
-IND	10	I	Inverting input, channel D
+IND	11	I	Noninverting input, channel D
V-	12	P	Negative (lowest) power supply
OUTD	13	O	Output, channel D
OUTC	14	O	Output, channel C

(1)I=Input, O=Output, P=Power



## SPECIFICATIONS

### Absolute Maximum Ratings

Over operating free-air temperature range (unless otherwise noted) <sup>(1)</sup>

		MIN	MAX	UNIT
Voltage	Supply, $V_s=(V+) - (V-)$		7	V
	Input pin (IN+, IN-) <sup>(2)</sup>	(V-)-0.3	(V+) +0.3	
	Signal output pin <sup>(3)</sup>	(V-)-0.3	(V+) +0.3	
Current	Signal input pin (IN+, IN-) <sup>(2)</sup>	-10	10	mA
	Signal output pin <sup>(3)</sup>	-55	55	mA
	Output short-circuit <sup>(4)</sup>	Continuous		
Temperature	Operating range, $T_A$	-40	85	°C
	Junction, $T_J$		150	
	Storage, $T_{stg}$	-65	150	

(1) Stresses above these ratings may cause permanent damage. Exposure to absolute maximum conditions for extended periods may degrade device reliability. These are stress ratings only, and functional operation of the device at these or any other conditions beyond those specified is not implied.

(2) Input terminals are diode-clamped to the power-supply rails. Input signals that can swing more than 0.5V beyond the supply rails should be current-limited to 10mA or less.

(3) Output terminals are diode-clamped to the power-supply rails. Output signals that can swing more than 0.5V beyond the supply rails should be current-limited to  $\pm 55$ mA or less.

(4) Short-circuit from output to  $V_{CC}$  can cause excessive heating and eventual destruction.

### ESD Ratings

			VALUE	UNIT
$V_{(ESD)}$	Electrostatic discharge	Human-body model (HBM), per ANSI/ESDA/JEDEC JS-001, all pins <sup>(1)</sup>	2000	V
		Charged device model (CDM), per JEDEC specification JESD22-C101, all pins <sup>(2)</sup>	1000	

(1) JEDEC document JEP155 states that 500V HBM allows safe manufacturing with a standard ESD control process.

(2) JEDEC document JEP157 states that 250V CDM allows safe manufacturing with a standard ESD control process.

### Recommended Operating Conditions

Over operating free-air temperature range (unless otherwise noted)

		MIN	NOM	MAX	UNIT
Supply voltage, $V_s=(V+) - (V-)$	Single-supply	1.8		5.5	V
	Dual-supply	$\pm 0.9$		$\pm 2.75$	

### Thermal Information:RS331

THERMAL METRIC <sup>(1)</sup>		RS331	UNIT
		5PINS	
		SOT23-5	
$R_{\theta JA}$	Junction-to-ambient thermal resistance	273.8	°C/W
$R_{\theta JC(top)}$	Junction-to-case(top) thermal resistance	126.8	°C/W
$R_{\theta JB}$	Junction-to-board thermal resistance	85.9	°C/W
$\Psi_{JT}$	Junction-to-top characterization parameter	10.9	°C/W
$\Psi_{JB}$	Junction-to-board characterization parameter	84.9	°C/W
$R_{\theta JC(bot)}$	Junction-to-case(bottom) thermal resistance	N/A	°C/W



## RS331, RS393, RS339

### Thermal Information:RS393

THERMAL METRIC <sup>(1)</sup>		RS393		UNIT
		8PINS		
		SOIC-8(SOP-8)		
R <sub>θJA</sub>	Junction-to-ambient thermal resistance	116		°C/W
R <sub>θJC(top)</sub>	Junction-to-case(top) thermal resistance	60		°C/W
R <sub>θJB</sub>	Junction-to-board thermal resistance	56		°C/W
Ψ <sub>JT</sub>	Junction-to-top characterization parameter	12.8		°C/W
Ψ <sub>JB</sub>	Junction-to-board characterization parameter	98.3		°C/W
R <sub>θJC(bot)</sub>	Junction-to-case(bottom) thermal resistance	N/A		°C/W

### Thermal Information:RS339

THERMAL METRIC <sup>(1)</sup>		RS339		UNIT
		14PINS		
		SOIC-14(SOP-14)	TSSOP-14	
R <sub>θJA</sub>	Junction-to-ambient thermal resistance	83.8	205.8	°C/W
R <sub>θJC(top)</sub>	Junction-to-case(top) thermal resistance	70.7	106.7	°C/W
R <sub>θJB</sub>	Junction-to-board thermal resistance	59.5	133.9	°C/W
Ψ <sub>JT</sub>	Junction-to-top characterization parameter	11.6	34.4	°C/W
Ψ <sub>JB</sub>	Junction-to-board characterization parameter	37.7	132.6	°C/W
R <sub>θJC(bot)</sub>	Junction-to-case(bottom) thermal resistance	N/A	N/A	°C/W

### PACKAGE/ORDERING INFORMATION

Orderable Device	Package Type	Pin	Channel	Op Temp(°C)	Device Marking	Package Qty
RS331XF	SOT23-5	5	1	-40°C ~+85°C	331	Tape and Reel,3000
RS393XK	SOIC-8(SOP8)	8	2	-40°C ~+85°C	RS393	Tape and Reel,2500
RS339XP	SOIC-14(SOP14)	14	4	-40°C ~+85°C	RS339	Tape and Reel,2500
RS339XQ	TSSOP-14	14	4	-40°C ~+85°C	RS339	Tape and Reel,3000



**ELECTRICAL CHARACTERISTICS(V<sub>S</sub>=5.0V)**

(At T<sub>A</sub> = +25°C, V<sub>CM</sub>=V<sub>S</sub>/2, unless otherwise noted.)

PARAMETER		CONDITIONS	RS331/RS393/RS339			UNITS
			MIN	TYP	MAX	
<b>POWER SUPPLY</b>						
V <sub>S</sub>	Operating Voltage Range		1.8		5.5	V
I <sub>Q</sub>	Quiescent Current/per channel			50	100	μA
PSRR	Power-Supply Rejection Ratio	V <sub>S</sub> =1.8V to 5.5V, V <sub>CM</sub> =(V)+0.5V		70		dB
<b>INPUT</b>						
V <sub>OS</sub>	Input offset voltage		-3.5	±0.6	3.5	mV
ΔV <sub>OS</sub> /ΔT	Input Offset Voltage Drift	V <sub>CM</sub> =V <sub>S</sub> /2, -40°C ≤ T <sub>A</sub> ≤ 85°C		0.5		μV/°C
I <sub>B</sub>	Input Bias Current			1	10	pA
I <sub>OS</sub>	Input Offset Current			1	10	pA
V <sub>CM</sub>	Common-Mode Voltage Range	T <sub>A</sub> = -40°C to 85°C	(V <sub>-</sub> )-0.1		(V <sub>+</sub> )+0.1	V
CMRR	Power-Supply Rejection Ratio	V <sub>CM</sub> =-0.1 to 5.6V		70		dB
<b>OUTPUT</b>						
V <sub>SAT</sub>	Saturation Voltage	I <sub>O</sub> ≤4mA		150	350	mV
V <sub>OH</sub>	Output Pull-up Voltage Range				5.6	V
I <sub>O</sub>	Output Current(sinking)	V <sub>O</sub> ≤1.5V		27		mA
I <sub>LEAK</sub>	Output Leakage Current			0.01	10	nA
<b>SWITCHING</b>						
T <sub>PHL</sub>	Propagation Delay H To L	RPU=5.1KΩ, Overdrive =10mV		205		ns
		RPU=5.1KΩ, Overdrive =100mV		185		
T <sub>PLH</sub>	Propagation Delay L To H	RPU=5.1KΩ, Overdrive =10mV		660		
		RPU=5.1KΩ, Overdrive =100mV		700		
T <sub>F</sub>	Fall Time	RPU=5.1KΩ, Overdrive =100mV		42		ns



**ELECTRICAL CHARACTERISTICS(V<sub>S</sub>=2.7V)**

(At T<sub>A</sub> = +25°C, V<sub>CM</sub>=V<sub>S</sub>/2, unless otherwise noted.)

PARAMETER		CONDITIONS	RS331/RS393/RS339			UNITS
			MIN	TYP	MAX	
<b>POWER SUPPLY</b>						
V <sub>S</sub>	Operating Voltage Range		1.8		5.5	V
I <sub>Q</sub>	Quiescent Current/per channel			48	80	μA
PSRR	Power-Supply Rejection Ratio	V <sub>S</sub> =1.8V to 5.5V, V <sub>CM</sub> =(V)+0.5V		70		dB
<b>INPUT</b>						
V <sub>OS</sub>	Input offset voltage		-3.5	±0.6	3.5	mV
ΔV <sub>OS</sub> /ΔT	Input Offset Voltage Drift	V <sub>CM</sub> =V <sub>S</sub> /2, -40°C ≤ T <sub>A</sub> ≤85°C		0.5		μV/°C
I <sub>B</sub>	Input Bias Current			1	10	pA
I <sub>OS</sub>	Input Offset Current			1	10	pA
V <sub>CM</sub>	Common-Mode Voltage Range	T <sub>A</sub> = -40°C to 85°C	(V <sub>-</sub> )-0.1		(V <sub>+</sub> )+0.1	V
CMRR	Power-Supply Rejection Ratio	V <sub>CM</sub> =-0.1 to 2.8V		70		dB
<b>OUTPUT</b>						
V <sub>SAT</sub>	Saturation Voltage	I <sub>O</sub> ≤2.2mA		144		mV
V <sub>OH</sub>	Output Pull-up Voltage Range				5.6	V
I <sub>O</sub>	Output Current(sinking)	V <sub>O</sub> ≤1.5V		13		mA
I <sub>LEAK</sub>	Output Leakage Current			0.01	10	nA
<b>SWITCHING</b>						
T <sub>PHL</sub>	Propagation Delay H To L	RPU=5.1KΩ, Overdrive =10mV		250		ns
		RPU=5.1KΩ, Overdrive=100mV		230		
T <sub>PLH</sub>	Propagation Delay L To H	RPU=5.1KΩ, Overdrive =10mV		680		
		RPU=5.1KΩ, Overdrive=100mV		702		
T <sub>F</sub>	Fall Time	RPU=5.1KΩ, Overdrive=100mV		52		ns



**ELECTRICAL CHARACTERISTICS(V<sub>S</sub>=1.8V)**

(At T<sub>A</sub> = +25°C, V<sub>CM</sub>=V<sub>S</sub>/2, unless otherwise noted.)

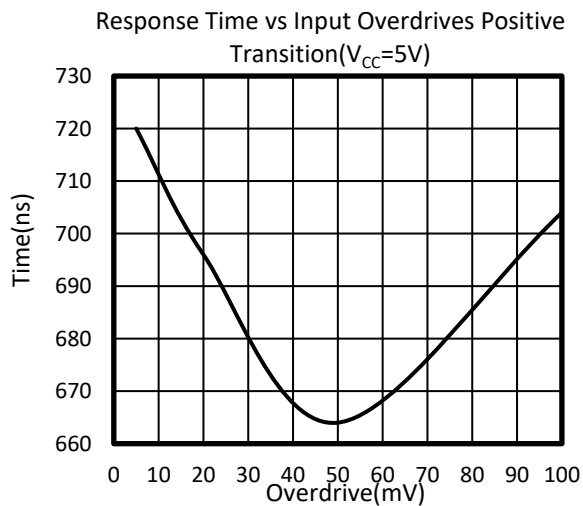
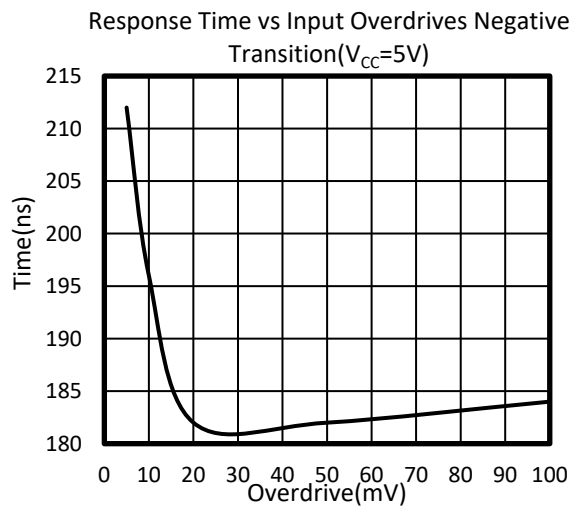
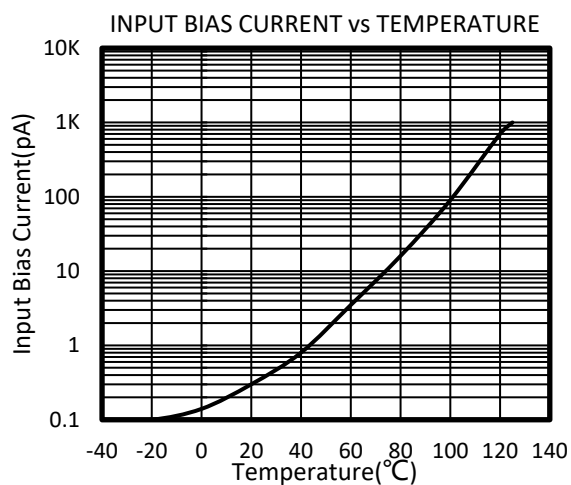
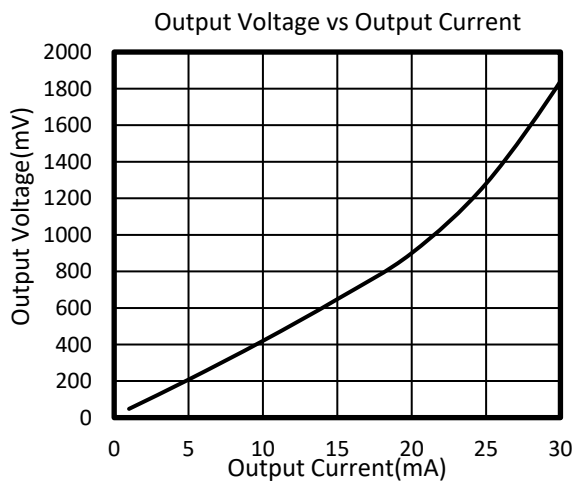
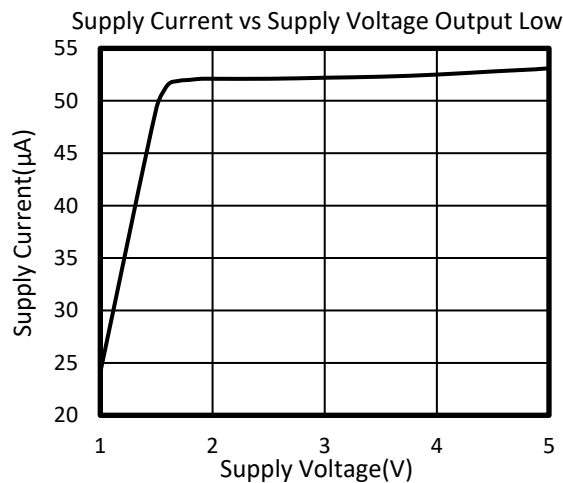
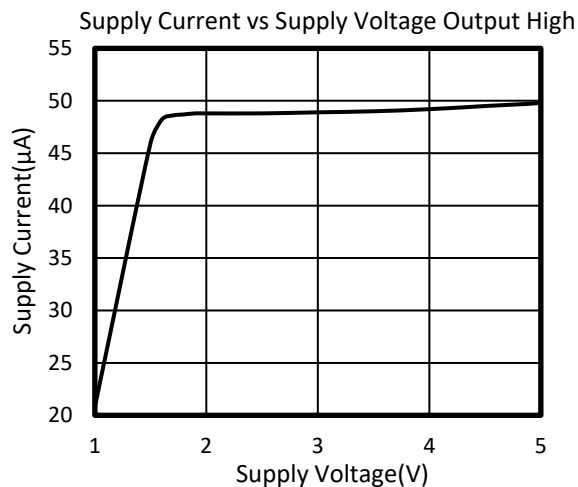
PARAMETER		CONDITIONS	RS331/RS393/RS339			UNITS
			MIN	TYP	MAX	
<b>POWER SUPPLY</b>						
V <sub>S</sub>	Operating Voltage Range		1.8		5.5	V
I <sub>Q</sub>	Quiescent Current/per channel			40	70	μA
PSRR	Power-Supply Rejection Ratio	V <sub>S</sub> =1.8V to 5.5V, V <sub>CM</sub> =(V)+0.5V		70		dB
<b>INPUT</b>						
V <sub>OS</sub>	Input offset voltage		-3.5	±0.6	3.5	mV
ΔV <sub>OS</sub> /ΔT	Input Offset Voltage Drift	V <sub>CM</sub> =V <sub>S</sub> /2, -40°C ≤ T <sub>A</sub> ≤85°C		0.5		μV/°C
I <sub>B</sub>	Input Bias Current			1	10	pA
I <sub>OS</sub>	Input Offset Current			1	10	pA
V <sub>CM</sub>	Common-Mode Voltage Range	T <sub>A</sub> = -40°C to 85°C	(V <sub>-</sub> )-0.1		(V <sub>+</sub> )+0.1	V
CMRR	Power-Supply Rejection Ratio	V <sub>CM</sub> =-0.1 to 1.9V		70		dB
<b>OUTPUT</b>						
V <sub>SAT</sub>	Saturation Voltage	I <sub>O</sub> ≤1.5mA		144		mV
V <sub>OH</sub>	Output Pull-up Voltage Range				5.6	V
I <sub>O</sub>	Output Current(sinking)	V <sub>O</sub> ≤0.8V		5		mA
I <sub>LEAK</sub>	Output Leakage Current			0.01	10	nA
<b>SWITCHING</b>						
T <sub>PHL</sub>	Propagation Delay H To L	RPU=5.1KΩ, Overdrive =10mV		272		ns
		RPU=5.1KΩ, Overdrive=100mV		270		
T <sub>PLH</sub>	Propagation Delay L To H	RPU=5.1KΩ, Overdrive =10mV		712		
		RPU=5.1KΩ, Overdrive=100mV		706		
T <sub>F</sub>	Fall Time	RPU=5.1KΩ, Overdrive=100mV		110		ns

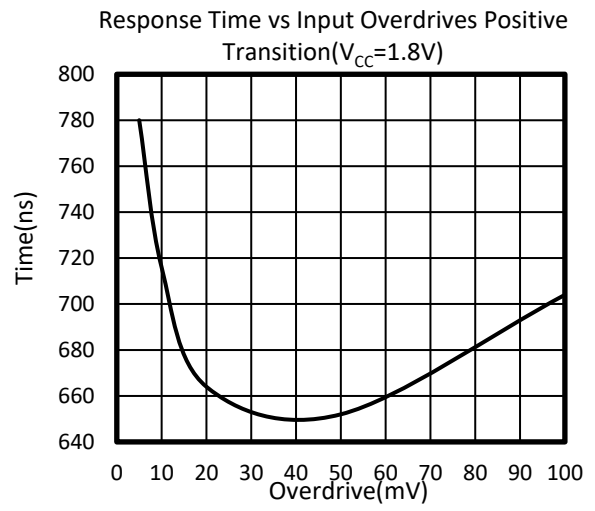
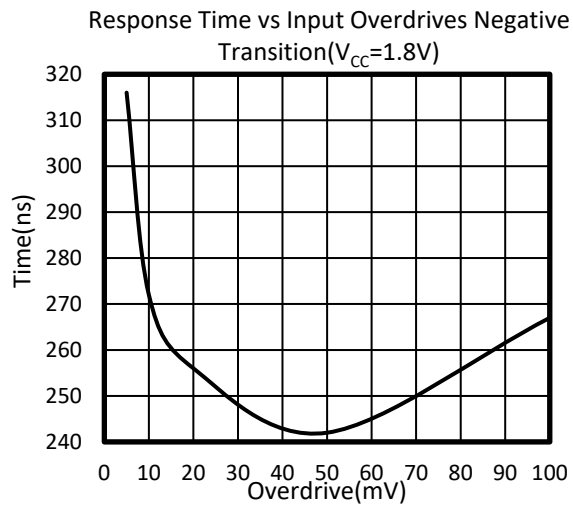




## TYPICAL CHARACTERISTICS

At  $T_A = +25^\circ\text{C}$ ,  $V_S=5\text{V}$ ,  $V_{CM} = V_S/2$ ,  $C_L=15\text{pF}$  unless otherwise noted.





## Detailed Description

### Overview

The RS331, RS393 and RS339 family of comparators can operate up to 5.5V on the supply pin. This standard device has proven ubiquity and versatility across a wide range of applications. This is due to its low power and high speed. The open-drain output allows the user to configure the output's logic low voltage ( $V_{OL}$ ) and can be utilized to enable the comparator to be used in AND functionality.

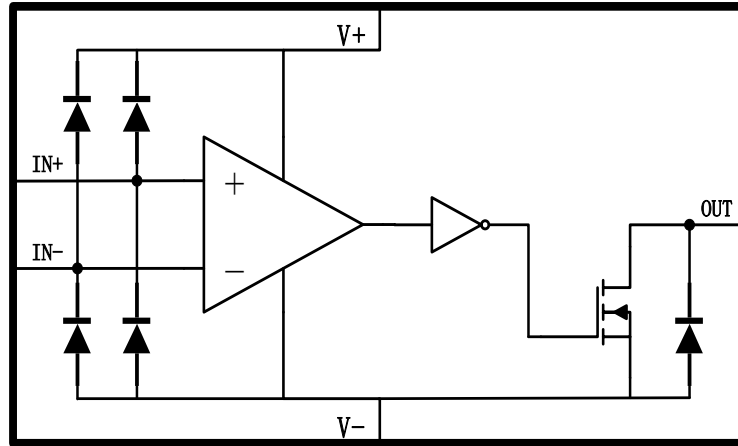


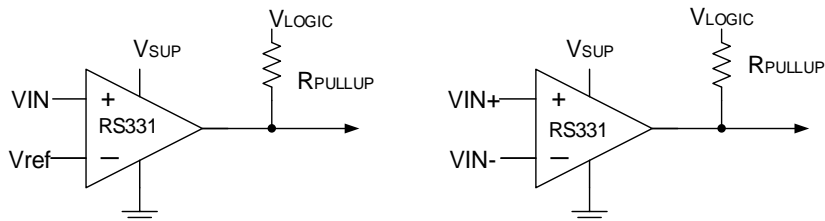
Figure 1. Functional Block Diagram

## Application and Implementation

### Application Information

RS331, RS393 and RS339 will typically be used to compare a single signal to a reference or two signals against each other. Many users take advantage of the open drain output (logic high with pull-up) to drive the comparison logic output to a logic voltage level to an MCU or logic device.

### Typical Application



**Figure 2. Typical Application Schematic**

### Power Supply Recommendations

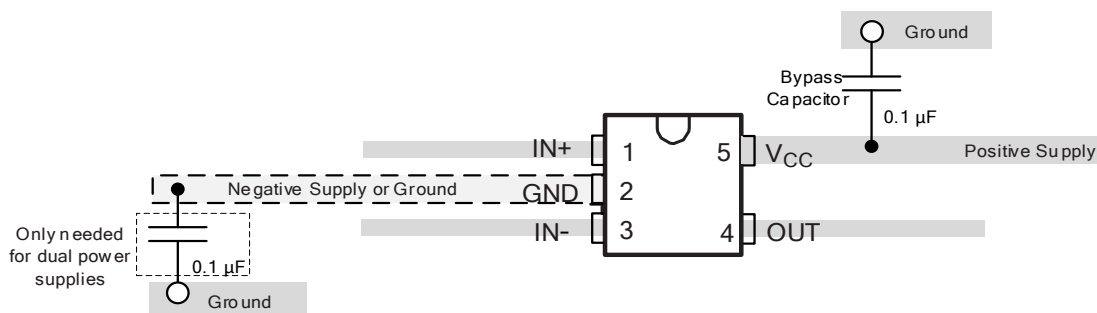
For fast response and comparison applications with noisy or AC inputs, it is recommended to use a bypass capacitor on the supply pin to reject any variation on the supply voltage. This variation causes temporary fluctuations in the comparator's input common mode range and create an inaccurate comparison.

## Layout

### Layout Guidelines

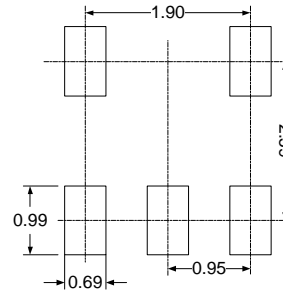
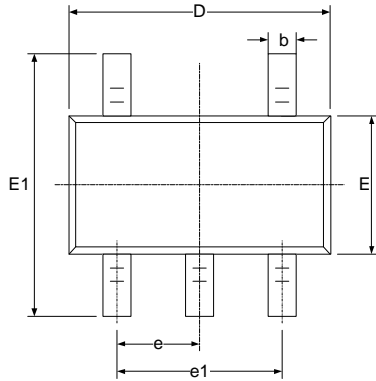
For accurate comparator applications without hysteresis it is important maintain a stable power supply with minimized noise and glitches, which can affect the high-level input common mode voltage range. In order to achieve this, it is best to add a bypass capacitor between the supply voltage and ground. This should be implemented on the positive power supply and negative supply (if available). If a negative supply is not being used, do not put a capacitor between the IC's GND pin and system ground.

### Layout Example

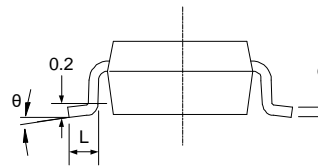
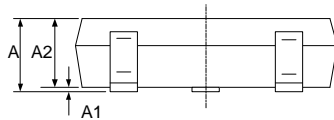


**Figure 3. RS331 Layout Example**

## PACKAGE OUTLINE DIMENSIONS SOT23-5

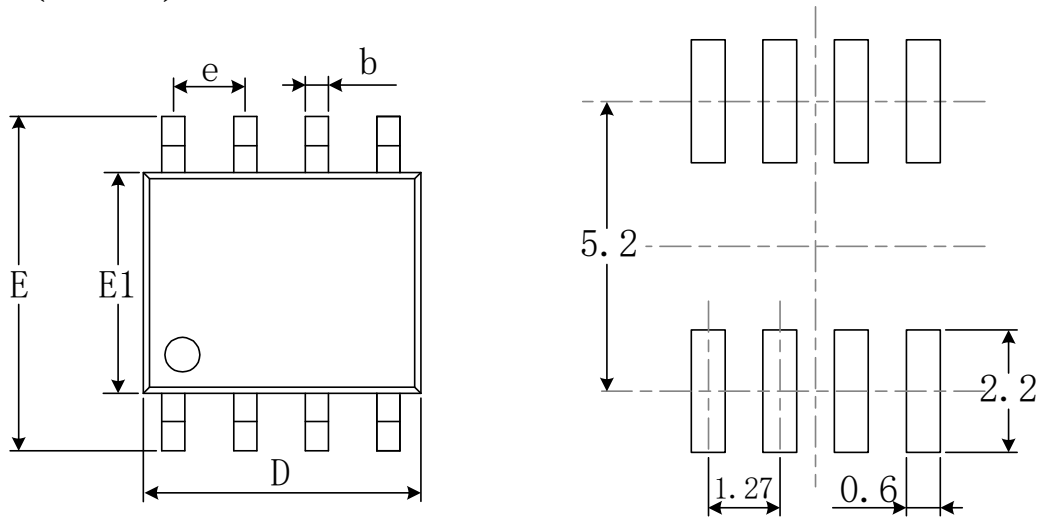


RECOMMENDED LAND PATTERN (Unit: mm)



Symbol	Dimensions In Millimeters		Dimensions In Inches	
	Min	Max	Min	Max
A	1.050	1.250	0.041	0.049
A1	0.000	0.100	0.000	0.004
A2	1.050	1.150	0.041	0.045
b	0.300	0.500	0.012	0.020
c	0.100	0.200	0.004	0.008
D	2.820	3.020	0.111	0.119
E	1.500	1.700	0.059	0.067
E1	2.650	2.950	0.104	0.116
e	0.950(BSC)		0.037(BSC)	
e1	1.800	2.000	0.071	0.079
L	0.300	0.600	0.012	0.024
θ	0°	8°	0°	8°

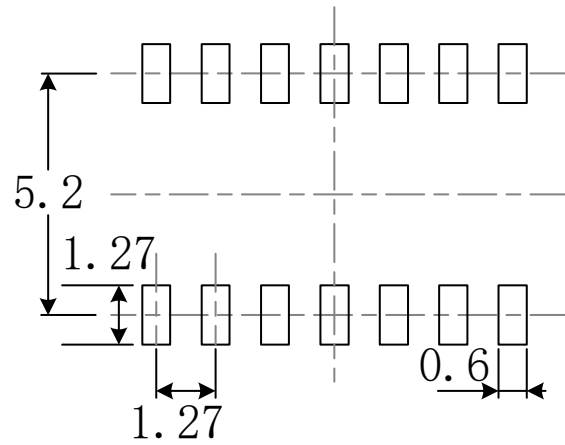
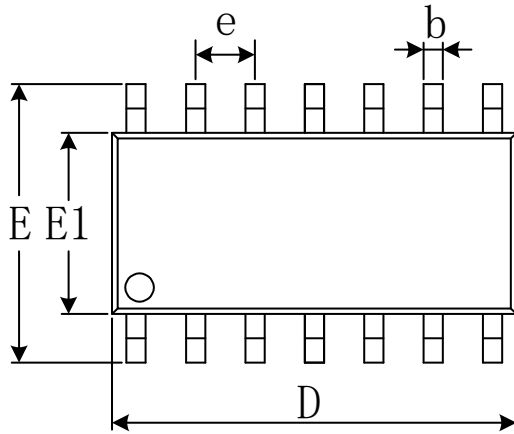
## SOIC-8(SOP8)



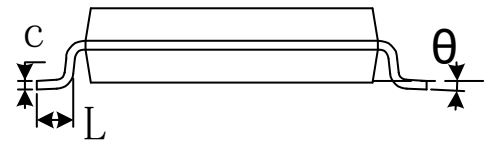
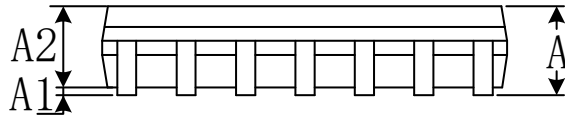
RECOMMENDED LAND PATTERN (Unit: mm)

Symbol	Dimensions In Millimeters		Dimensions In Inches	
	Min	Max	Min	Max
A	1.350	1.750	0.053	0.069
A1	0.100	0.250	0.004	0.010
A2	1.350	1.550	0.053	0.061
b	0.330	0.510	0.013	0.020
c	0.170	0.250	0.007	0.010
D	4.800	5.000	0.189	0.197
e	1.270(BSC)		0.050(BSC)	
E	5.800	6.200	0.228	0.244
E1	3.800	4.000	0.150	0.157
L	0.400	1.270	0.016	0.050
$\theta$	0°	8°	0°	8°

## SOIC-14(SOP14)

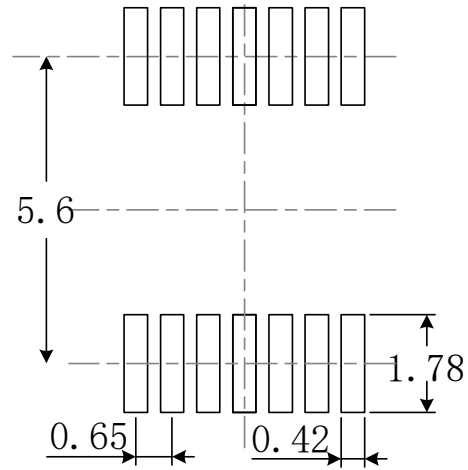
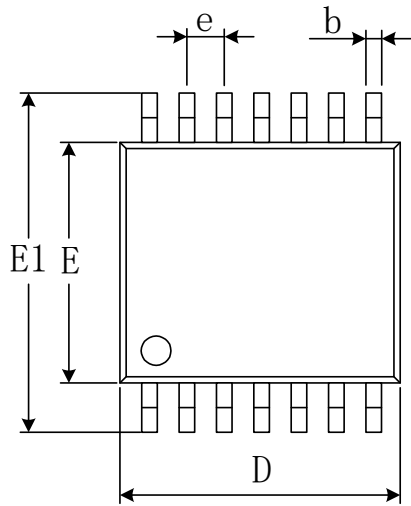


RECOMMENDED LAND PATTERN (Unit: mm)

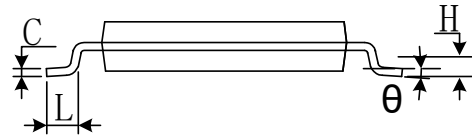
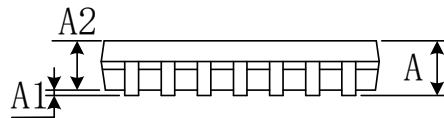


Symbol	Dimensions In Millimeters		Dimensions In Inches	
	Min	Max	Min	Max
A	1.350	1.750	0.053	0.069
A1	0.100	0.250	0.004	0.010
A2	1.350	1.550	0.053	0.061
b	0.310	0.510	0.012	0.020
c	0.100	0.250	0.004	0.010
D	8.450	8.850	0.333	0.348
e	1.270(BSC)		0.050(BSC)	
E	5.800	6.200	0.228	0.244
E1	3.800	4.000	0.150	0.157
L	0.400	1.270	0.016	0.050
$\theta$	0°	8°	0°	8°

# TSSOP-14



RECOMMENDED LAND PATTERN (Unit: mm)



Symbol	Dimensions In Millimeters		Dimensions In Inches	
	Min	Max	Min	Max
A		1.200		0.047
A1	0.050	0.150	0.002	0.006
A2	0.800	1.050	0.031	0.041
b	0.190	0.300	0.007	0.012
c	0.090	0.200	0.004	0.008
D	4.860	5.100	0.191	0.201
E	4.300	4.500	0.169	0.177
E1	6.250	6.550	0.246	0.258
e	0.650(BSC)		0.026(BSC)	
L	0.500	0.700	0.020	0.028
H	0.25(TYP)		0.01(TYP)	
$\theta$	1°	7°	1°	7°



## X-ON Electronics

Largest Supplier of Electrical and Electronic Components

*Click to view similar products for [Analog Comparators](#) category:*

*Click to view products by [RUNIC](#) manufacturer:*

Other Similar products are found below :

[633740E](#) [ADCMP396ARZ-RL7](#) [NCV2200SN2T1G](#) [NCV2200SQ2T2G](#) [SC339DR2G](#) [LM2901SNG](#) [LM339SNG](#) [AP393AM8G-13](#)  
[418524AB](#) [TS393CD C3](#) [LM393SNG](#) [55122](#) [5962-8757203IA](#) [MAX971ESA+T](#) [MAX961ESAT](#) [MAX944ESD+T](#) [MAX931ESAT](#)  
[MAX984CPE](#) [MAX9062EBSTG45](#) [MAX9041AEUTT](#) [MAX9022ASAT](#) [RT2902YDT](#) [M38510/11201B2A](#) [NTE911](#) [5962-8751601DA](#)  
[5962-8751601CA](#) [MAX961EUA+T](#) [MAX9065EBS+TG45](#) [NCV2202SN2T1G](#) [MAX919ESA+T](#) [LT6700HS6-2#TRMPBF](#) [MAX19005CCS+](#)  
[LM339EDR2G](#) [LT6700HS6-2#TRM](#) [NTE919](#) [NTE922](#) [TS883IQ2T](#) [LT6700HVCS6-3#TRMPBF](#) [LT6700HVHS6-3#TRMPBF](#)  
[MAX978EEE+T](#) [MAX975ESA+T](#) [MAX9602EUG+T](#) [MAX997EUA+T](#) [MIC841NYC5-T5](#) [LM393WDT](#) [MCP6564T-E/STVAO](#)  
[MAX983ESA+T](#) [NCX2200GMAZ](#) [LTC1540CMS8#PBF](#) [MC10E1651FNG](#)