

General-Purpose Low-Voltage Open-Drain Output Comparator

1 FEATURES

- **Qualified for Automotive Applications**
- **AEC-Q100 Qualified with the Grade 1**
- **Supply Range: +1.8V to +5.5V**
- **Low Supply Current 50μA (TYP) per channel at $V_S = 5V$**
- **Input Common-Mode Voltage Range Includes Ground**
- **Low Output Saturation Voltage 150mV Typical**
- **Open-Drain Output for Maximum Flexibility**
- **SPECIFIED UP TO +125°C**
- **Micro SIZE PACKAGES: SOT23-5**

2 APPLICATIONS

- **Hysteresis Comparators**
- **Oscillators**
- **Window Comparators**
- **Industrial Equipment**
- **Test and Measurement**

3 DESCRIPTIONS

The RS331-Q1 and RS393-Q1 is the single and dual comparator version, the RS339-Q1 is quad comparator version, and both are open-drain output comparators for maximum flexibility. It can operate from 1.8V to 5.5V, and have low power consuming 50μA (TYP) per channel.

The RS331-Q1, RS393-Q1 and RS339-Q1 are the most cost-effective solutions for applications where low voltage operation, low power and space saving are the primary specifications in circuit design for portable consumer products.

The RS331-Q1, RS393-Q1 and RS339-Q1 are available in Green SOT23-5, SOIC-8, MSOP-8, SOIC-14 and TSSOP-14 packages. It operates over an ambient temperature range of -40°C to +125°C.

Device Information (1)

PART NUMBER	PACKAGE	BODY SIZE (NOM)
RS331-Q1	SOT23-5	1.62mm×2.92mm
RS393-Q1	SOIC-8(SOP8)	4.90mm×3.90mm
	MSOP-8	3.00mm×3.00mm
RS339-Q1	SOIC-14 (SOP14)	8.65mm×3.90mm
	TSSOP-14	5.00mm×4.40mm

(1) For all available packages, see the orderable addendum at the end of the data sheet.

Table of Contents

1 FEATURES	1
2 APPLICATIONS	1
3 DESCRIPTIONS	1
4 Revision History	3
5 PACKAGE/ORDERING INFORMATION ⁽¹⁾	4
6 Pin Configuration and Functions (Top View)	5
7 SPECIFICATIONS	7
7.1 Absolute Maximum Ratings	7
7.2 ESD Ratings	7
7.3 Recommended Operating Conditions	7
7.4 ELECTRICAL CHARACTERISTICS($V_S=5.0V$)	8
7.5 ELECTRICAL CHARACTERISTICS($V_S=1.8V$)	9
7.6 TYPICAL CHARACTERISTICS	10
8 Detailed Description	16
8.1 Overview	16
9 Application and Implementation	17
9.1 Application Information	17
9.2 Typical Application	17
9.3 Power Supply Recommendations	17
10 Layout	18
10.1 Layout Guidelines	18
10.2 Layout Example	18
11 PACKAGE OUTLINE DIMENSIONS	19
12 TAPE AND REEL INFORMATION	25

4 Revision History

Note: Page numbers for previous revisions may differ from page numbers in the current version.

VERSION	Change Date	Change Item
A.1	2023/05/23	Initial version completed

5 PACKAGE/ORDERING INFORMATION (1)

Orderable Device	Package Type	Pin	Channel	Lead finish/Ball material (2)	MSL Peak Temp (3)	Op Temp(°C)	Device Marking (4)	Package Qty
RS331XF-Q1	SOT23-5	5	1	NIPDAUAG	MSL1-260°-Unlimited	-40°C ~+125°C	331	Tape and Reel,3000
RS393XK-Q1	SOIC-8 (SOP8)	8	2	NIPDAUAG	MSL1-260°-Unlimited	-40°C ~+125°C	RS393	Tape and Reel,4000
RS393XM-Q1	MSOP-8	8	2	NIPDAUAG	MSL1-260°-Unlimited	-40°C ~+125°C	RS393	Tape and Reel,4000
RS339XP-Q1	SOIC-14 (SOP14)	14	4	NIPDAUAG	MSL1-260°-Unlimited	-40°C ~+125°C	RS339	Tape and Reel, 4000
RS339XQ-Q1	TSSOP-14	14	4	NIPDAUAG	MSL1-260°-Unlimited	-40°C ~+125°C	RS339	Tape and Reel, 4000

NOTE:

- (1) This information is the most current data available for the designated devices. This data is subject to change without notice and revision of this document. For browser-based versions of this data sheet, refer to the right-hand navigation.
- (2) Lead finish/Ball material. Orderable Devices may have multiple material finish options. Finish options are separated by a vertical ruled line. Lead finish/Ball material values may wrap to two lines if the finish value exceeds the maximum column width.
- (3) MSL Peak Temp. The Moisture Sensitivity Level rating according to the JEDEC industry standard classifications, and peak solder temperature.
- (4) There may be additional marking, which relates to the lot trace code information (data code and vendor code), the logo or the environmental category on the device.

6 Pin Configuration and Functions (Top View)

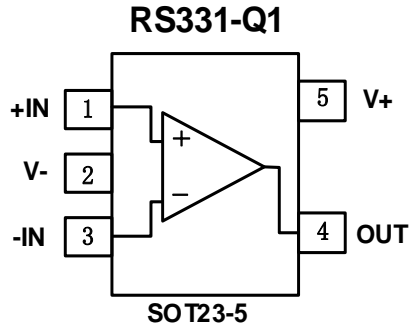

Pin Description

NAME	PIN	I/O ⁽¹⁾	DESCRIPTION
	SOT23-5		
+IN	1	I	Noninverting input
V-	2	P	Negative (lowest) power supply
-IN	3	I	Inverting input
OUT	4	O	Output
V+	5	P	Positive (highest) power supply

(1) I=Input, O=Output, P=Power.

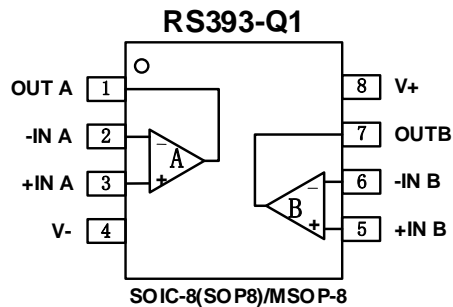

Pin Description

NAME	PIN	I/O ⁽¹⁾	DESCRIPTION
	SOIC-8(SOP8)/MSOP-8		
OUTA	1	O	Output, channel A
-INA	2	I	Inverting input, channel A
+INA	3	I	Noninverting input, channel A
V-	4	P	Negative (lowest) power supply
+INB	5	I	Noninverting input, channel B
-INB	6	I	Inverting input, channel B
OUTB	7	O	Output, channel B
V+	8	P	Positive (highest) power supply

(1) I=Input, O=Output, P=Power.

Pin Configuration and Functions (Top View)

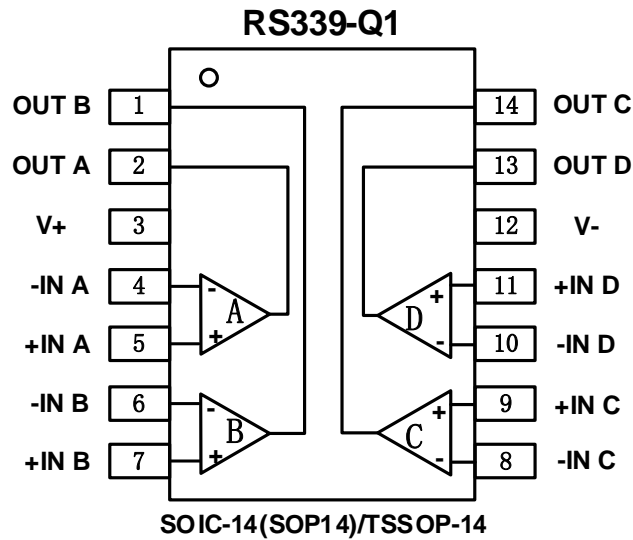

Pin Description

NAME	PIN	I/O ⁽¹⁾	DESCRIPTION
	SOIC-14(SOP14)/TSSOP-14		
OUTB	1	O	Output, channel B
OUTA	2	O	Output, channel A
V+	3	P	Positive (highest) power supply
-INA	4	I	Inverting input, channel A
+INA	5	I	Noninverting input, channel A
-INB	6	I	Inverting input, channel B
+INB	7	I	Noninverting input, channel B
-INC	8	I	Inverting input, channel C
+INC	9	I	Noninverting input, channel C
-IND	10	I	Inverting input, channel D
+IND	11	I	Noninverting input, channel D
V-	12	P	Negative (lowest) power supply
OUTD	13	O	Output, channel D
OUTC	14	O	Output, channel C

(1) I=Input, O=Output, P=Power.

7 SPECIFICATIONS

7.1 Absolute Maximum Ratings

Over operating free-air temperature range (unless otherwise noted) ⁽¹⁾

		MIN	MAX	UNIT	
Voltage	Supply, $V_S=(V+) - (V-)$		7	V	
	Input pin (IN+, IN-) ⁽²⁾	(V-)-0.3	(V+) +0.3		
	Signal output pin ⁽³⁾	(V-)-0.3	(V+) +0.3		
Current	Signal input pin (IN+, IN-) ⁽²⁾	-10	10	mA	
	Output short-circuit duration ⁽⁴⁾		10	s	
θ_{JA}	Package thermal impedance ⁽⁵⁾	SOT23-5		230	°C/W
		SOIC-8(SOP8)		110	
		MSOP-8		165	
		SOIC-14(SOP14)		105	
		TSSOP14		90	
Temperature	Operating range, T_A	-40	125	°C	
	Junction, T_J ⁽⁶⁾	-40	150		
	Storage, T_{stg}	-65	150		

(1) Stresses above these ratings may cause permanent damage. Exposure to absolute maximum conditions for extended periods may degrade device reliability. These are stress ratings only, and functional operation of the device at these or any other conditions beyond those specified is not implied.

(2) Input signals that can swing more than 0.3V beyond the supply rails should be current-limited to ± 10 mA or less.

(3) Output signals that can swing more than 0.3V beyond the supply rails should be current-limited to ± 55 mA or less.

(4) Short-circuit to V- or V+. Short circuits from outputs can cause excessive heating and eventual destruction.

(5) The package thermal impedance is calculated in accordance with JESD-51.

(6) The maximum power dissipation is a function of $T_{J(MAX)}$, $R_{\theta JA}$, and T_A . The maximum allowable power dissipation at any ambient temperature is $P_D = (T_{J(MAX)} - T_A) / R_{\theta JA}$. All numbers apply for packages soldered directly onto a PCB.

7.2 ESD Ratings

The following ESD information is provided for handling of ESD-sensitive devices in an ESD protected area only.

		VALUE	UNIT	
$V_{(ESD)}$	Electrostatic discharge	Human-Body Model (HBM), per AEC Q100-002 ⁽¹⁾	± 2000	V
		Charged-Device Model (CDM), per AEC Q100-011	± 500	
		Latch-Up (LU), per AEC Q100-004	± 100	mA

(1) AEC Q100-002 indicates that HBM stressing shall be in accordance with the ANSI/ESDA/JEDEC JS-001 specification.



ESD SENSITIVITY CAUTION

ESD damage can range from subtle performance degradation to complete device failure. Precision integrated circuits may be more susceptible to damage because very small parametric changes could cause the device not to meet its published specifications.

7.3 Recommended Operating Conditions

Over operating free-air temperature range (unless otherwise noted)

		MIN	NOM	MAX	UNIT
Supply voltage, $V_S=(V+) - (V-)$	Single-supply	1.8		5.5	V
	Dual-supply	± 0.9		± 2.75	

7.4 ELECTRICAL CHARACTERISTICS(V_S=5.0V)

(At T_A = +25°C, V_{CM}=V_S/2, Full=-40°C to +125°C, unless otherwise noted.)⁽¹⁾

PARAMETER		CONDITIONS	T _J	RS331-Q1/RS393-Q1/RS339-Q1			
				MIN ⁽²⁾	TYP ⁽³⁾	MAX ⁽²⁾	UINT
POWER SUPPLY							
V _S	Operating Voltage Range		25°C	1.8		5.5	V
I _Q	Quiescent Current/per channel	RS331-Q1	25°C		60	190	μA
			Full			240	
		RS393_339-Q1	25°C		50	150	μA
			Full			200	
PSRR	Power-Supply Rejection Ratio	V _S =1.8V to 5.5V	25°C		75		dB
INPUT							
V _{OS}	Input offset voltage	V _{CM} =V _S /2	25°C	-4.5	±0.6	4.5	mV
			Full	-5		5	
ΔV _{OS} /ΔT	Input Offset Voltage Drift	V _{CM} =V _S /2	Full		±0.5		μV/°C
I _B	Input Bias Current ^{(4) (5)}		25°C		±10		pA
I _{OS}	Input Offset Current ⁽⁴⁾		25°C		±10		pA
V _{CM}	Common-Mode Voltage Range		Full	(V-)-0.1		(V+)+0.1	V
CMRR	Common-Mode Rejection Ratio	V _{CM} =-0.1 to 5.6V	25°C		65		dB
OUTPUT							
V _{SAT}	Saturation Voltage	I _O =4mA	25°C		150	350	mV
			Full			400	
V _{OH}	Output Pull-up Voltage Range		25°C			5.5	V
I _O	Output Current(sinking)	V _O =2.5V	25°C	30	35		mA
			Full	20			
I _{LEAK}	Output Leakage Current		25°C		0.01	80	nA
			Full			100	
SWITCHING							
T _{PHL}	Propagation Delay H To L ⁽⁶⁾	R _{PU} =5.1KΩ, Overdrive =10mV	25°C		220		ns
		R _{PU} =5.1KΩ, Overdrive =100mV	25°C		120		
T _{PLH}	Propagation Delay L To H ⁽⁶⁾	R _{PU} =5.1KΩ, Overdrive =10mV	25°C		550		
		R _{PU} =5.1KΩ, Overdrive =100mV	25°C		320		
T _F	Fall Time	R _{PU} =5.1KΩ, Overdrive =100mV 10% to 90%	25°C		20		ns

NOTE:

- Electrical table values apply only for factory testing conditions at the temperature indicated. Factory testing conditions result in very limited self-heating of the device.
- Limits are 100% production tested at 25°C. Limits over the operating temperature range are ensured through correlations using statistical quality control (SQC) method.
- Typical values represent the most likely parametric norm as determined at the time of characterization. Actual typical values may vary over time and will also depend on the application and configuration.
- This parameter is ensured by design and/or characterization and is not tested in production.
- Positive current corresponds to current flowing into the device.
- High-to-low and low-to-high refers to the transition at the input.

7.5 ELECTRICAL CHARACTERISTICS(V_S=1.8V)

(At T_A = +25°C, V_{CM}=V_S/2, Full=-40°C to +125°C, unless otherwise noted.)⁽¹⁾

PARAMETER		CONDITIONS	T _J	RS331-Q1/RS393-Q1/RS339-Q1			
				MIN ⁽²⁾	TYP ⁽³⁾	MAX ⁽²⁾	UINT
POWER SUPPLY							
V _S	Operating Voltage Range		25°C	1.8		5.5	V
I _Q	Quiescent Current/per channel	RS331-Q1	25°C		45	150	μA
			Full			180	
		RS393_339-Q1	25°C		40	135	μA
			Full			165	
PSRR	Power-Supply Rejection Ratio	V _S =1.8V to 5.5V	25°C		75		dB
INPUT							
V _{OS}	Input offset voltage	V _{CM} =V _S /2	25°C	-4.5	±0.6	4.5	mV
			Full	-5		5	
ΔV _{OS} /ΔT	Input Offset Voltage Drift	V _{CM} =V _S /2	Full		±0.5		μV/°C
I _B	Input Bias Current ^{(4) (5)}		25°C		±10		pA
I _{OS}	Input Offset Current ⁽⁴⁾		25°C		±10		pA
V _{CM}	Common-Mode Voltage Range		Full	(V ₋)-0.1		(V ₊)+0.1	V
CMRR	Common-Mode Rejection Ratio	V _{CM} =-0.1 to 1.9V	25°C		60		dB
OUTPUT							
V _{SAT}	Saturation Voltage	I _O =2mA	25°C		150	450	mV
			Full			500	
V _{OH}	Output Pull-up Voltage Range		25°C			5.5	V
I _O	Output Current(sinking)	V _O =0.9V	25°C	4	5		mA
			Full	3			
I _{LEAK}	Output Leakage Current		25°C		0.01	80	nA
			Full			100	
SWITCHING							
T _{PHL}	Propagation Delay H To L ⁽⁶⁾	R _{PU} =5.1KΩ, Overdrive =10mV	25°C		300		ns
		R _{PU} =5.1KΩ, Overdrive=100mV	25°C		200		
T _{PLH}	Propagation Delay L To H ⁽⁶⁾	R _{PU} =5.1KΩ, Overdrive =10mV	25°C		500		
		R _{PU} =5.1KΩ, Overdrive=100mV	25°C		280		
T _F	Fall Time	R _{PU} =5.1KΩ, Overdrive=100mV 10% to 90%	25°C		60		ns

NOTE:

- (1) Electrical table values apply only for factory testing conditions at the temperature indicated. Factory testing conditions result in very limited self-heating of the device.
- (2) Limits are 100% production tested at 25°C. Limits over the operating temperature range are ensured through correlations using statistical quality control (SQC) method.
- (3) Typical values represent the most likely parametric norm as determined at the time of characterization. Actual typical values may vary over time and will also depend on the application and configuration.
- (4) This parameter is ensured by design and/or characterization and is not tested in production.
- (5) Positive current corresponds to current flowing into the device.
- (6) High-to-low and low-to-high refers to the transition at the input.

7.6 TYPICAL CHARACTERISTICS

NOTE: The graphs and tables provided following this note are a statistical summary based on a limited number of samples and are provided for informational purposes only.

At $T_A = +25^\circ\text{C}$, $V_S=5\text{V}$, $V_{CM} = V_S/2$, $C_L=15\text{pF}$ unless otherwise noted.

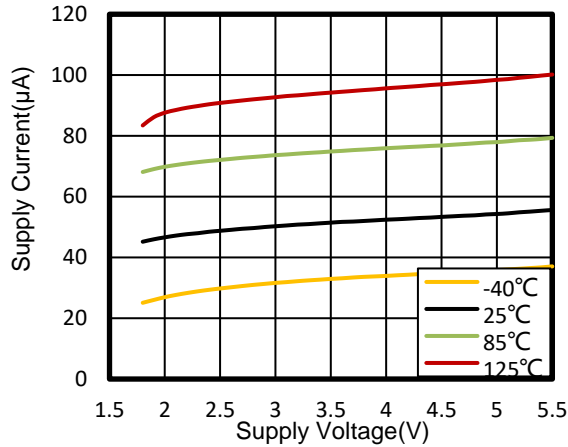

Figure 1. Supply Current vs Supply Voltage

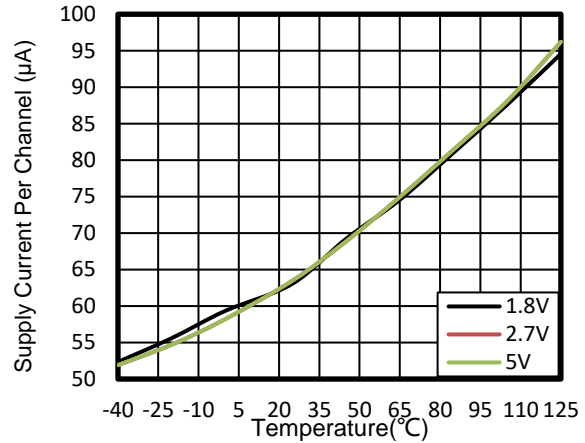

Figure 2. Supply Current vs Temperature

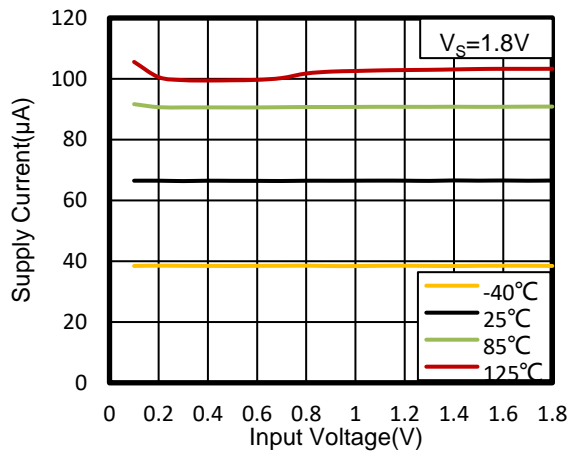

Figure 3. Supply Current vs Input Voltage

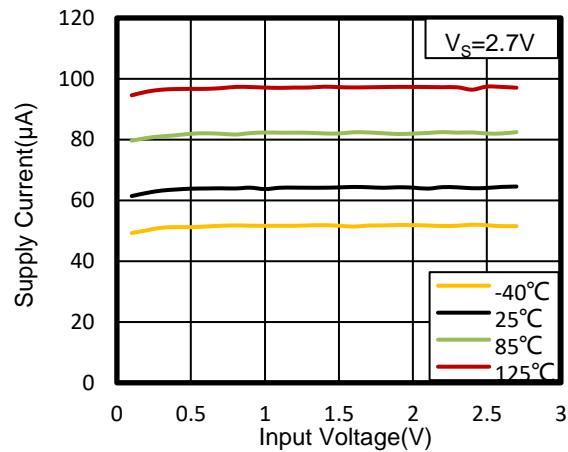

Figure 4. Supply Current vs Input Voltage

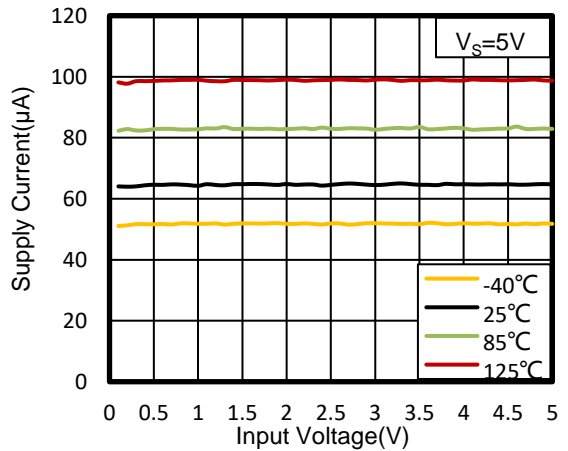

Figure 5. Supply Current vs Input Voltage

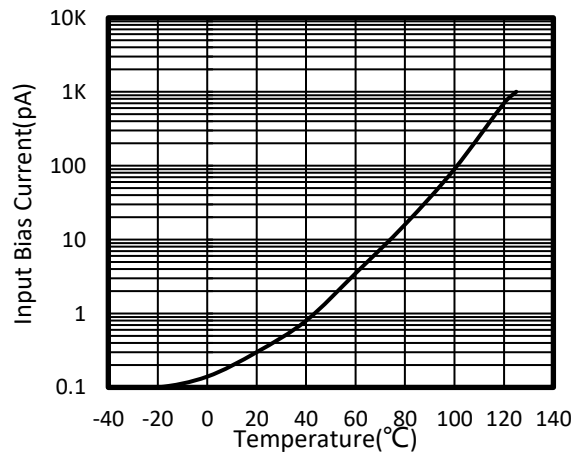

Figure 6. INPUT BIAS CURRENT vs TEMPERATURE

TYPICAL CHARACTERISTICS

NOTE: The graphs and tables provided following this note are a statistical summary based on a limited number of samples and are provided for informational purposes only.

At $T_A = +25^\circ\text{C}$, $V_S=5\text{V}$, $V_{CM} = V_S/2$, $C_L=15\text{pF}$ unless otherwise noted.

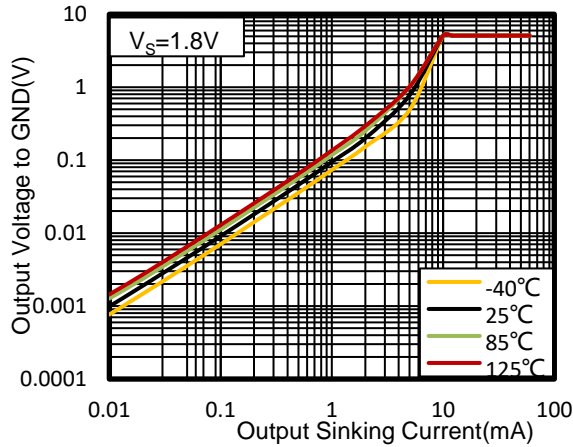

Figure 7. Output Voltage vs Output Sinking Current

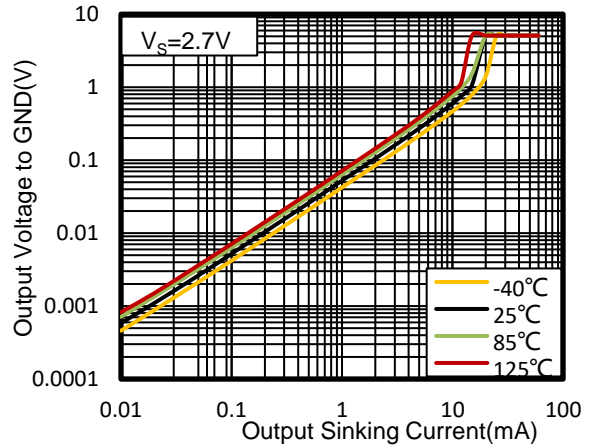

Figure 8. Output Voltage vs Output Sinking Current

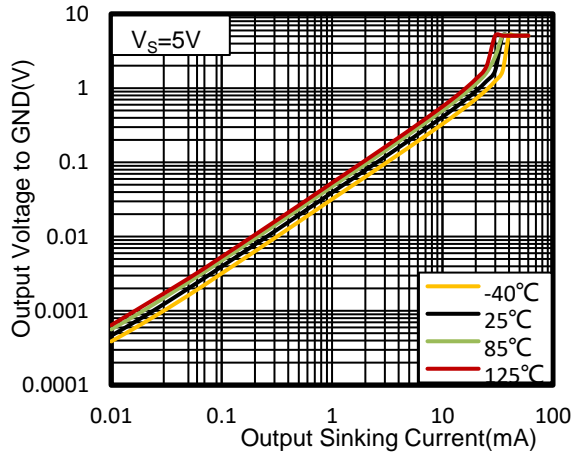

Figure 9. Output Voltage vs Output Sinking Current

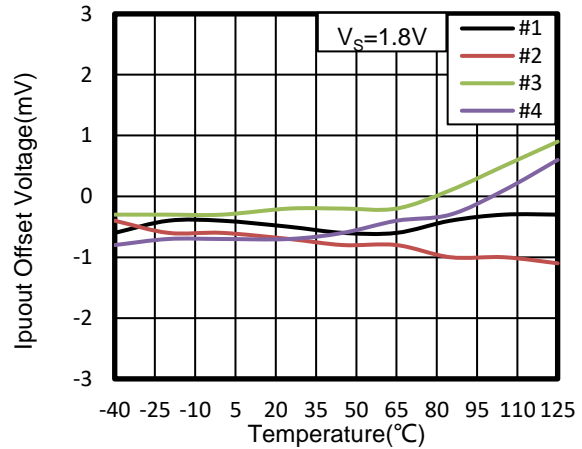

Figure 10. Input Offset Voltage vs Temperature

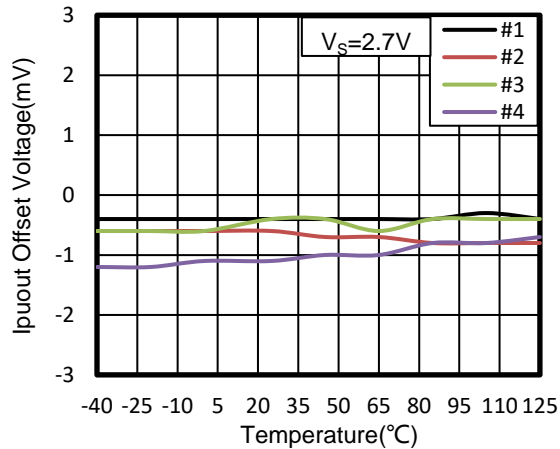

Figure 11. Input Offset Voltage vs Temperature

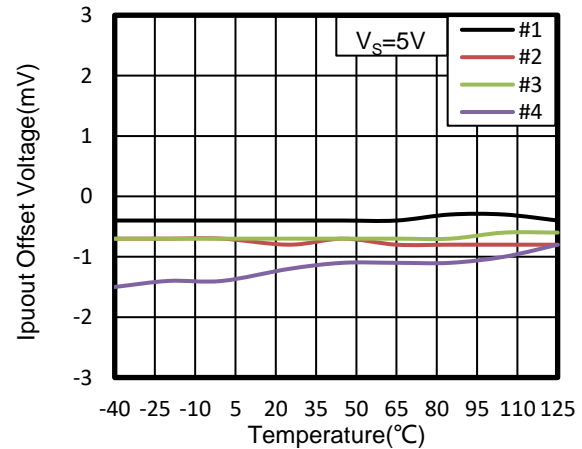

Figure 12. Input Offset Voltage vs Temperature

TYPICAL CHARACTERISTICS

NOTE: The graphs and tables provided following this note are a statistical summary based on a limited number of samples and are provided for informational purposes only.

At $T_A = +25^\circ\text{C}$, $V_S=5\text{V}$, $V_{CM} = V_S/2$, $C_L=15\text{pF}$ unless otherwise noted.

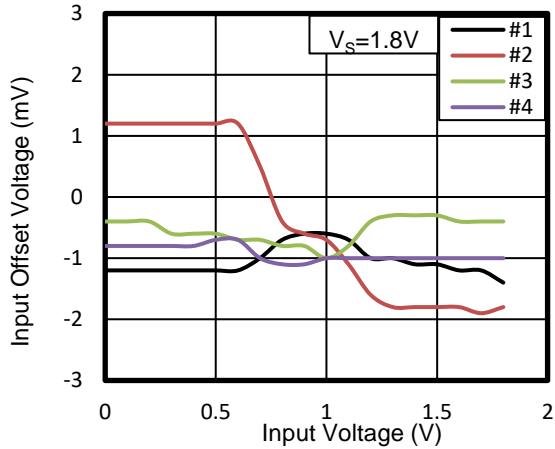

Figure 13. Offset Voltage vs Input Voltage at -40°C

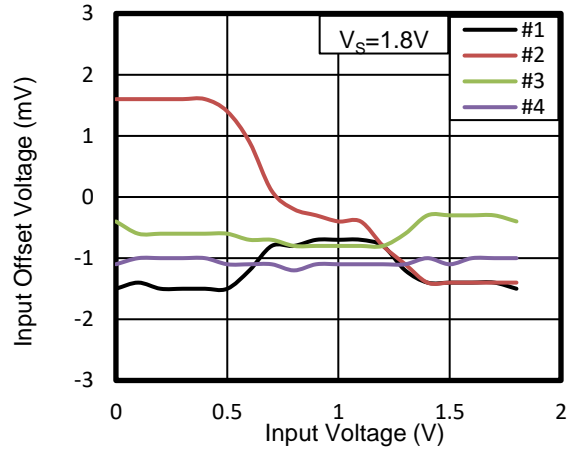

Figure 14. Offset Voltage vs Input Voltage at 25°C

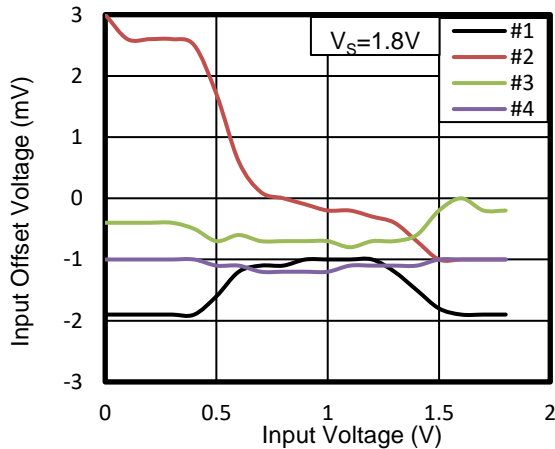

Figure 15. Offset Voltage vs Input Voltage at 85°C

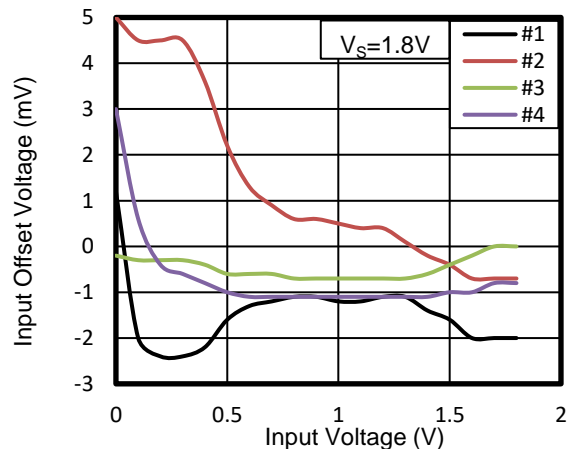

Figure 16. Offset Voltage vs Input Voltage at 125°C

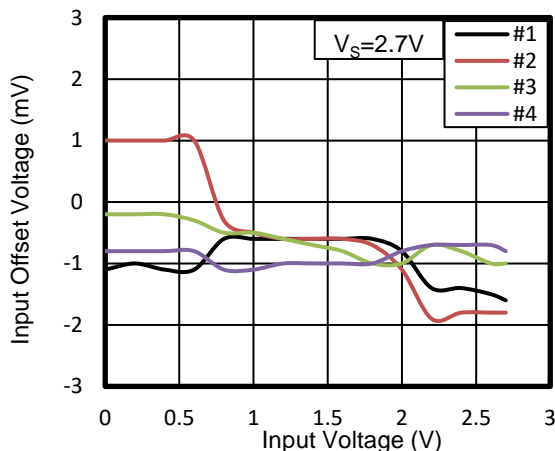

Figure 17. Offset Voltage vs Input Voltage at -40°C

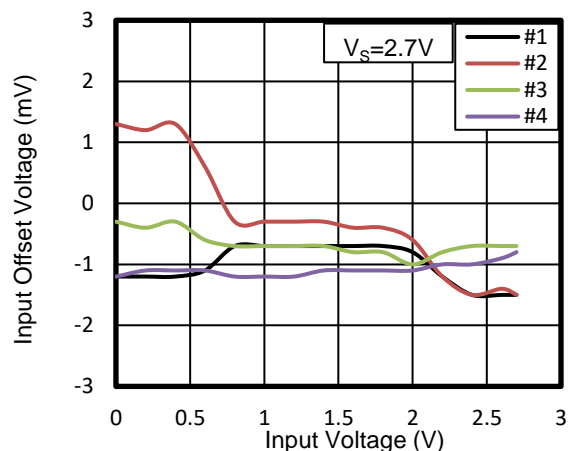

Figure 18. Offset Voltage vs Input Voltage at 25°C

TYPICAL CHARACTERISTICS

NOTE: The graphs and tables provided following this note are a statistical summary based on a limited number of samples and are provided for informational purposes only.

At $T_A = +25^\circ\text{C}$, $V_S=5\text{V}$, $V_{CM} = V_S/2$, $C_L=15\text{pF}$ unless otherwise noted.

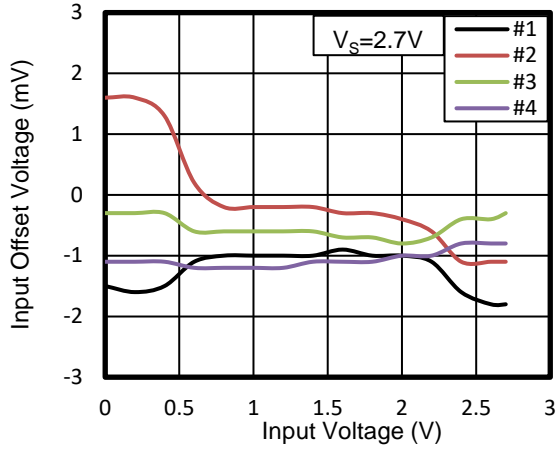

Figure 19. Offset Voltage vs Input Voltage at 85°C

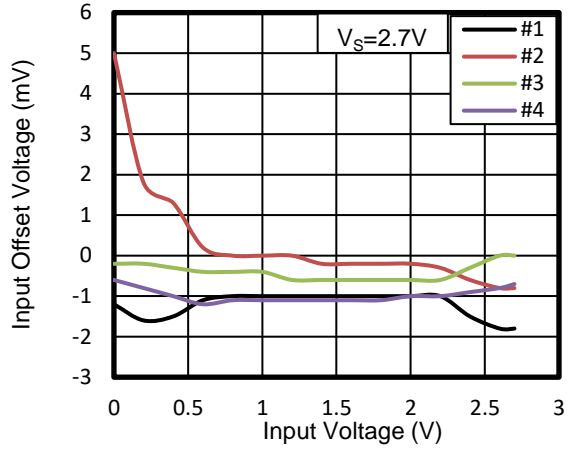

Figure 20. Offset Voltage vs Input Voltage at 125°C

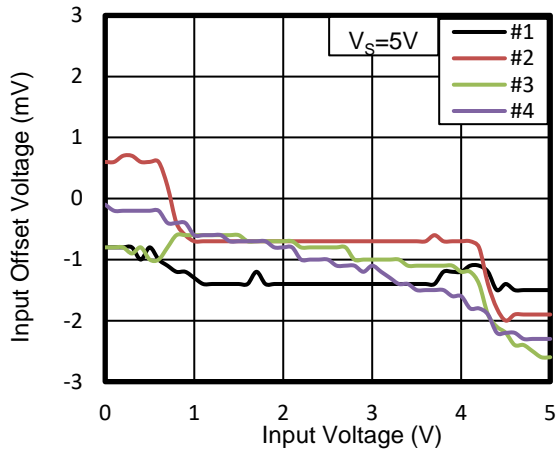

Figure 21. Offset Voltage vs Input Voltage at -40°C

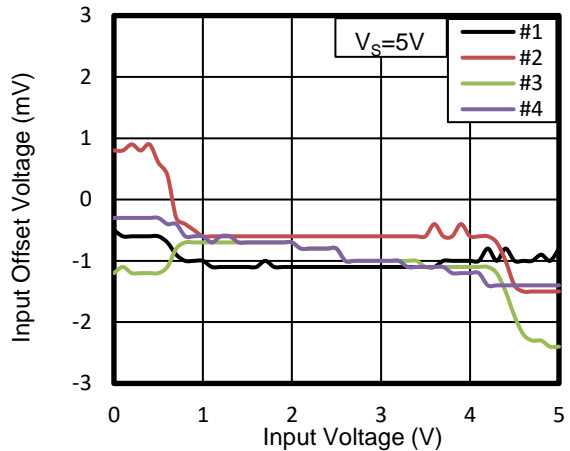

Figure 22. Offset Voltage vs Input Voltage at 25°C

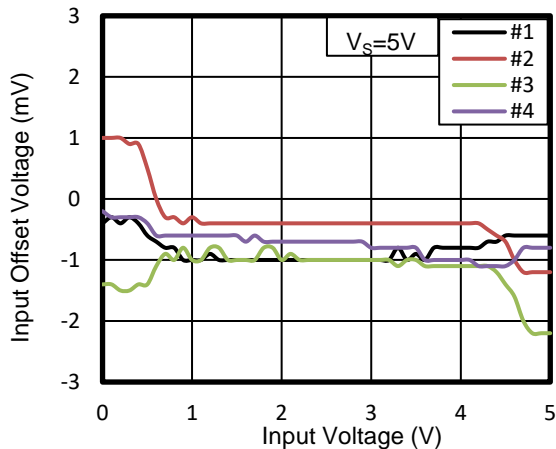

Figure 23. Offset Voltage vs Input Voltage at 85°C

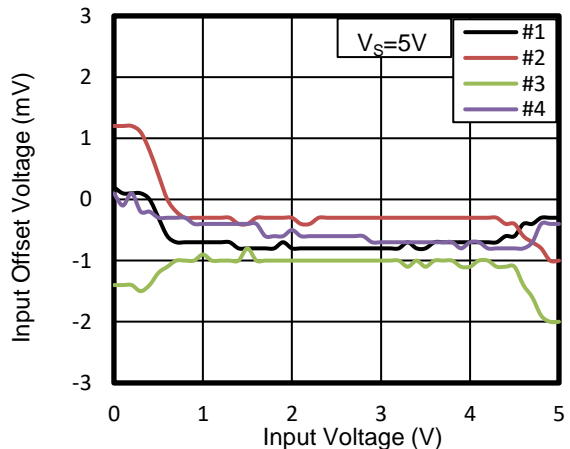

Figure 24. Offset Voltage vs Input Voltage at 125°C

TYPICAL CHARACTERISTICS

NOTE: The graphs and tables provided following this note are a statistical summary based on a limited number of samples and are provided for informational purposes only.

At $T_A = +25^\circ\text{C}$, $V_S=5\text{V}$, $V_{CM} = V_S/2$, $C_L=15\text{pF}$ unless otherwise noted.

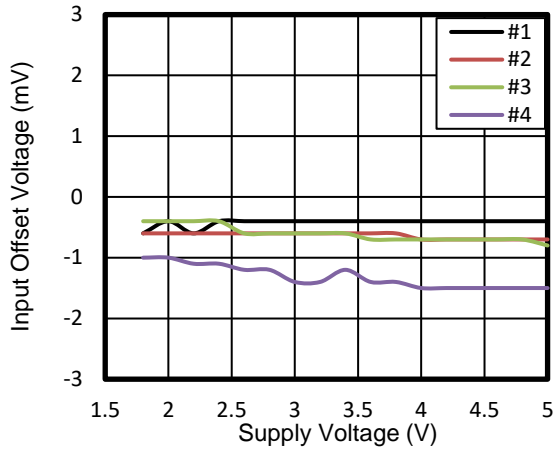

Figure 25. Input Offset Voltage vs Supply Voltage at -40°C

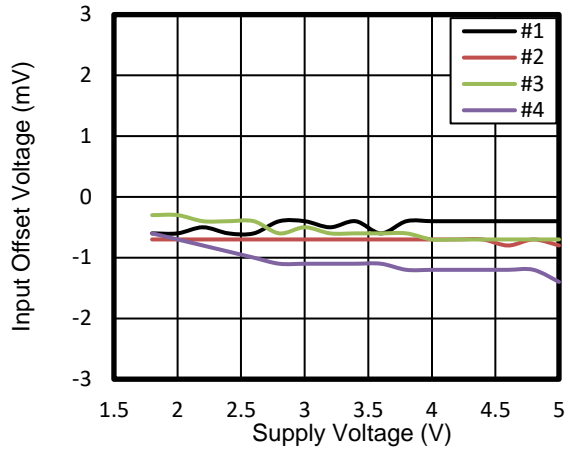

Figure 26. Input Offset Voltage vs Supply Voltage at 25°C

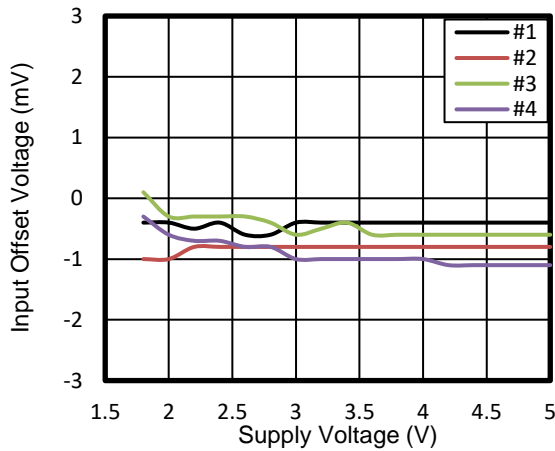

Figure 27. Input Offset Voltage vs Supply Voltage at 85°C

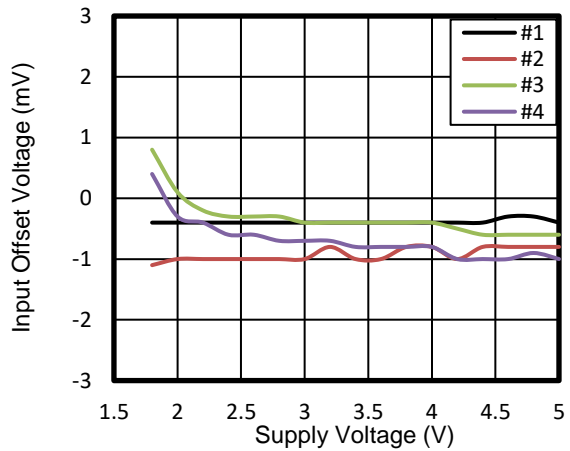

Figure 28. Input Offset Voltage vs Supply Voltage at 125°C

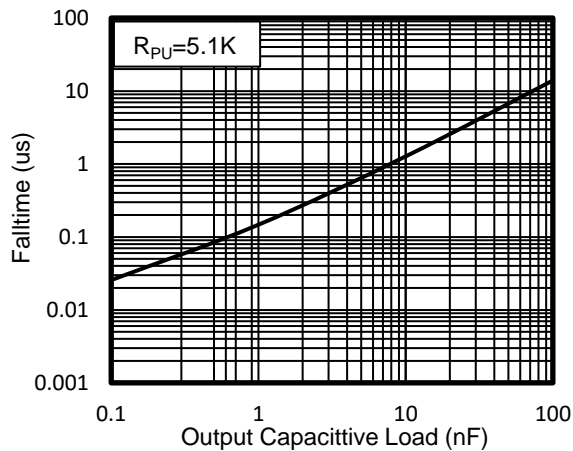

Figure 29. Falltime vs Capacitive Load

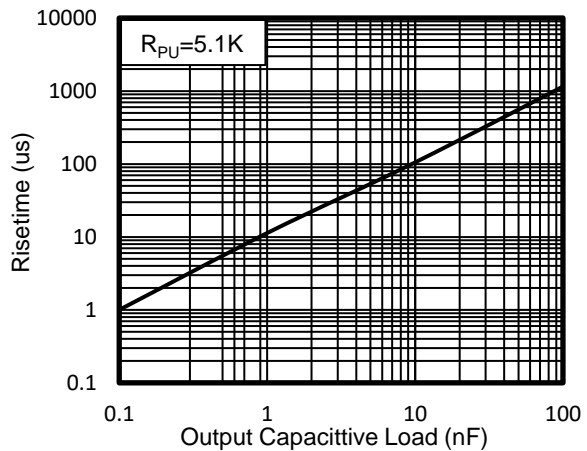

Figure 30. Risetime vs Capacitive Load

TYPICAL CHARACTERISTICS

NOTE: The graphs and tables provided following this note are a statistical summary based on a limited number of samples and are provided for informational purposes only.

At $T_A = +25^\circ\text{C}$, $V_S=5\text{V}$, $V_{CM} = V_S/2$, $C_L=15\text{pF}$ unless otherwise noted.

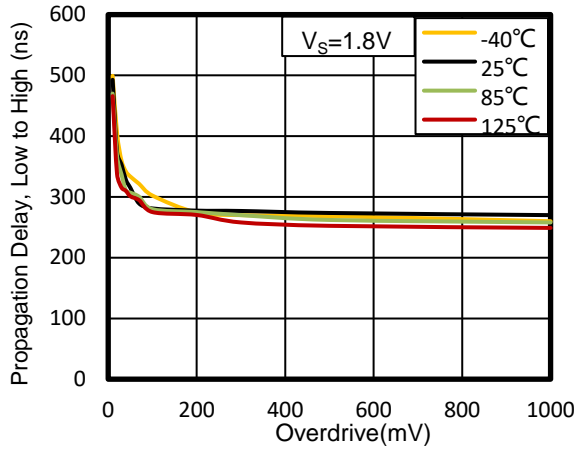

Figure 31. Low to High Propagation Delay vs Input Overdrive Voltage

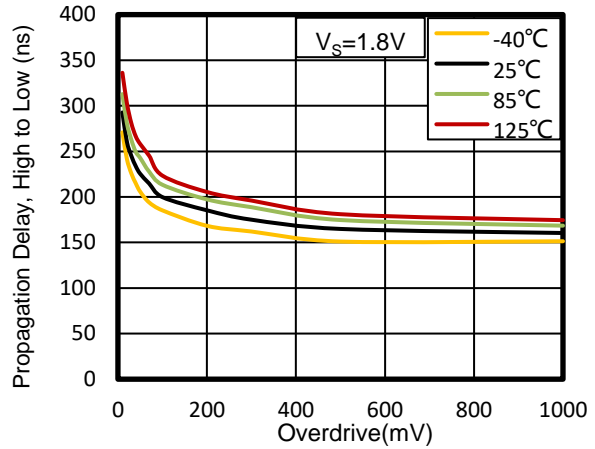

Figure 32. High to Low Propagation Delay vs Input Overdrive Voltage

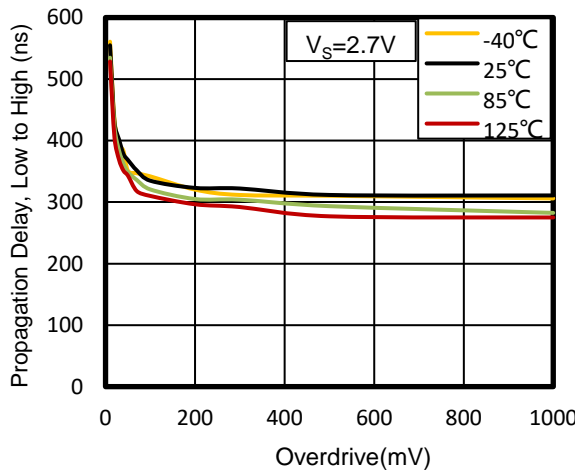

Figure 33. Low to High Propagation Delay vs Input Overdrive Voltage

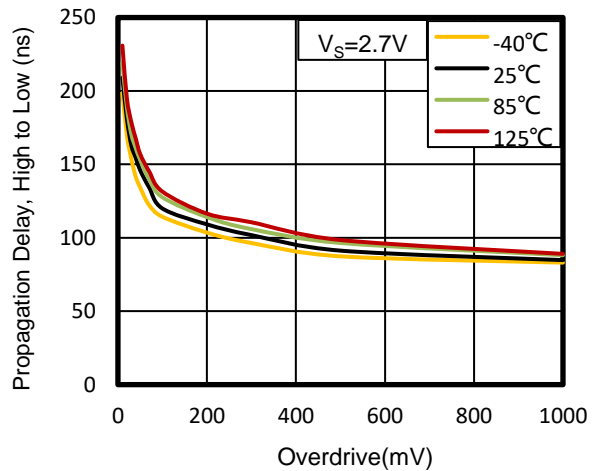

Figure 34. High to Low Propagation Delay vs Input Overdrive Voltage

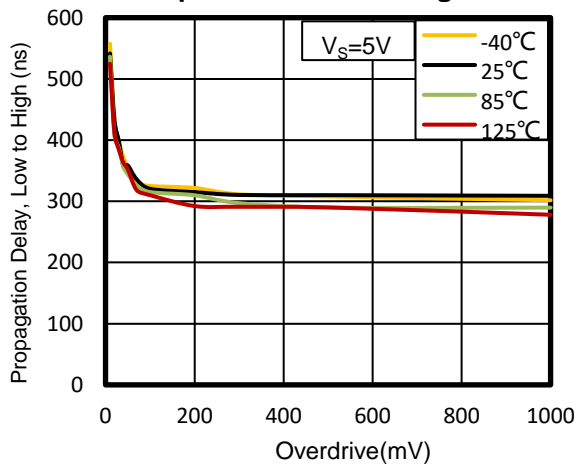

Figure 35. Low to High Propagation Delay vs Input Overdrive Voltage

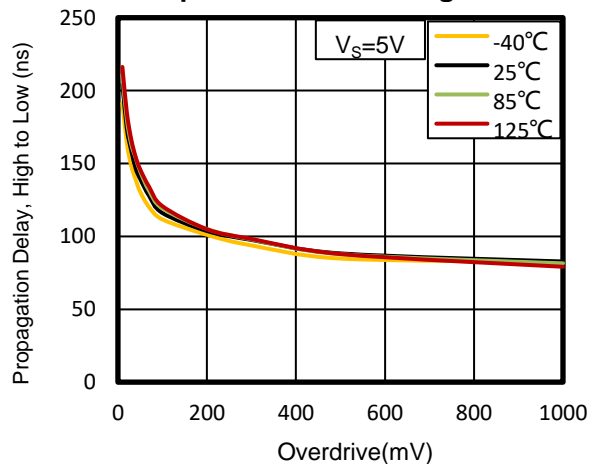

Figure 36. High to Low Propagation Delay vs Input Overdrive Voltage

8 Detailed Description

8.1 Overview

The RS331-Q1, RS393-Q1 and RS339-Q1 family of comparators can operate up to 5.5V on the supply pin. This standard device has proven ubiquity and versatility across a wide range of applications. This is due to its low power and high speed. The open-drain output allows the user to configure the output's logic low voltage (V_{OL}) and can be utilized to enable the comparator to be used in AND functionality.

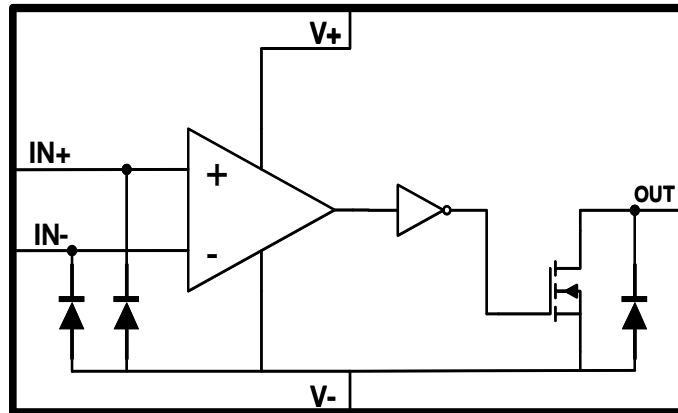

Figure 37. Functional Block Diagram

9 Application and Implementation

Information in the following applications sections is not part of the Runic component specification, and Runic does not warrant its accuracy or completeness. Runic's customers are responsible for determining suitability of components for their purposes. Customers should validate and test their design implementation to confirm system functionality.

9.1 Application Information

RS331-Q1, RS393-Q1 and RS339-Q1 will typically be used to compare a single signal to a reference or two signals against each other. Many users take advantage of the open drain output (logic high with pull-up) to drive the comparison logic output to a logic voltage level to an MCU or logic device.

9.2 Typical Application

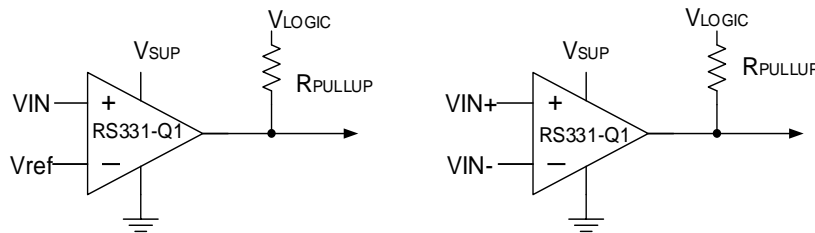

Figure 38. Typical Application Schematic

9.3 Power Supply Recommendations

For fast response and comparison applications with noisy or AC inputs, it is recommended to use a bypass capacitor on the supply pin to reject any variation on the supply voltage. This variation causes temporary fluctuations in the comparator's input common mode range and create an inaccurate comparison.

10 Layout

10.1 Layout Guidelines

For accurate comparator applications without hysteresis it is important maintain a stable power supply with minimized noise and glitches, which can affect the high-level input common mode voltage range. In order to achieve this, it is best to add a bypass capacitor between the supply voltage and ground. This should be implemented on the positive power supply and negative supply (if available). If a negative supply is not being used, do not put a capacitor between the IC's GND pin and system ground.

10.2 Layout Example

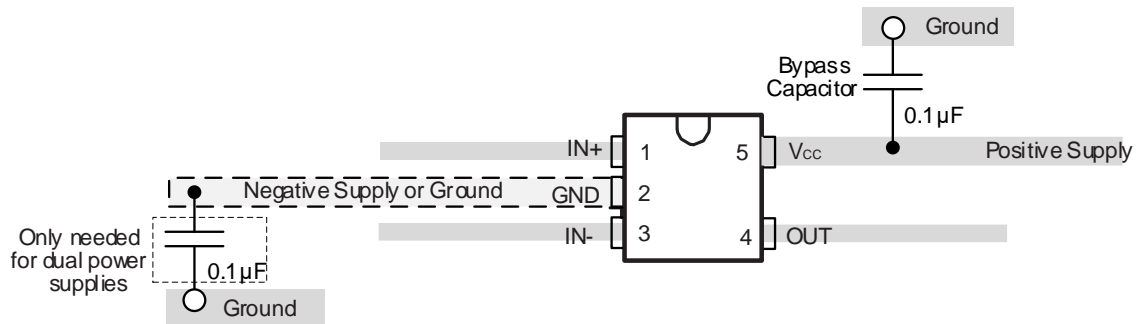
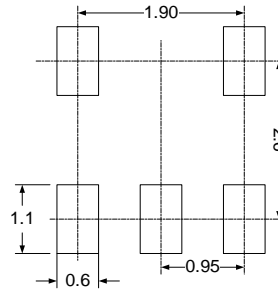
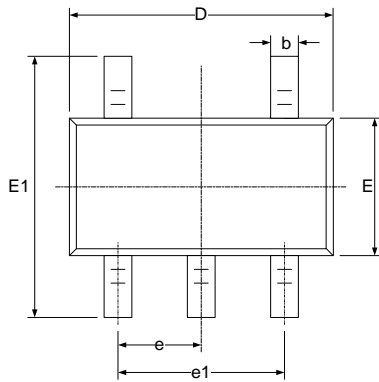

Figure 39. RS331-Q1 Layout Example

11 PACKAGE OUTLINE DIMENSIONS

SOT23-5



RECOMMENDED LAND PATTERN (Unit: mm)

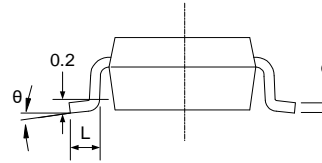
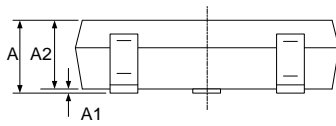

Symbol	Dimensions In Millimeters		Dimensions In Inches	
	Min	Max	Min	Max
A		1.250		0.049
A1	0.000	0.150	0.000	0.006
A2	1.000	1.200	0.039	0.047
b	0.360	0.500	0.014	0.020
c	0.100	0.200	0.004	0.008
D	2.826	3.026	0.111	0.119
E	1.526	1.726	0.060	0.068
E1	2.600	3.000	0.102	0.118
e	0.950(BSC)		0.037(BSC)	
e1	1.800	2.000	0.071	0.079
L	0.350	0.600	0.014	0.024
θ	0°	8°	0°	8°

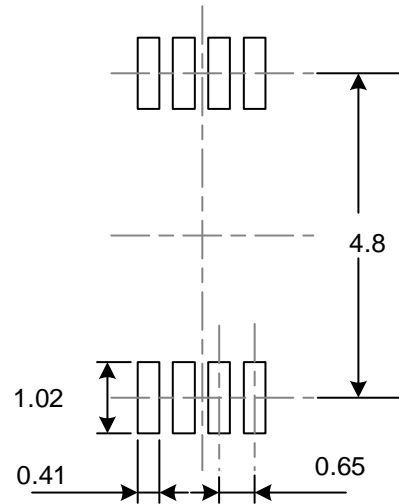
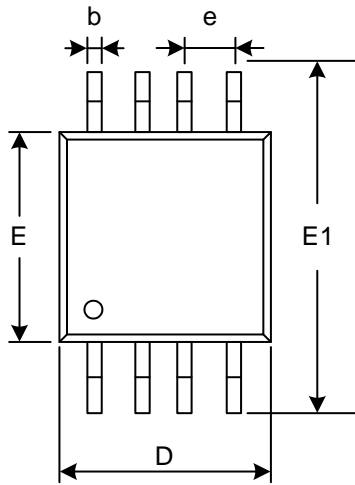
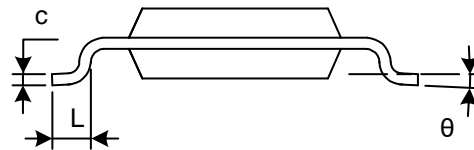
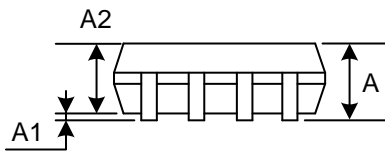
MSOP-8

RECOMMENDED LAND PATTERN (Unit: mm)

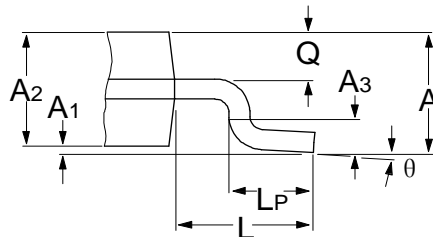
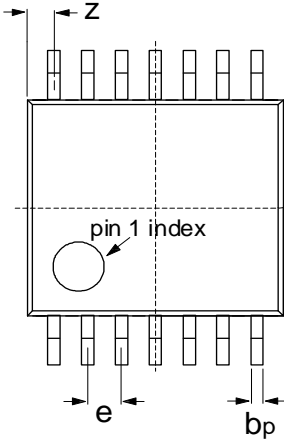
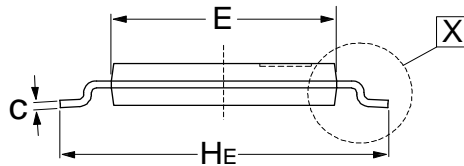
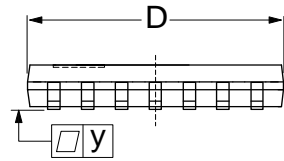
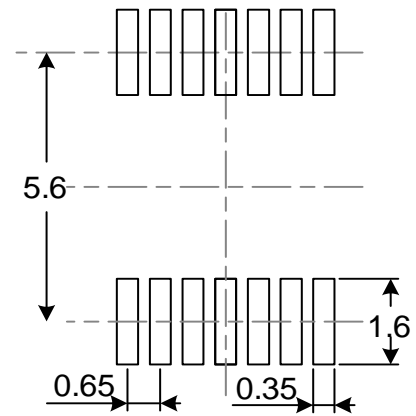
Symbol	Dimensions In Millimeters		Dimensions In Inches	
	Min	Max	Min	Max
A	0.820	1.100	0.032	0.043
A1	0.020	0.150	0.001	0.006
A2	0.750	0.950	0.030	0.037
b	0.250	0.380	0.010	0.015
c	0.090	0.230	0.004	0.009
D	2.900	3.100	0.114	0.122
e	0.650(BSC)		0.026(BSC)	
E	2.900	3.100	0.114	0.122
E1	4.750	5.050	0.187	0.199
L	0.400	0.800	0.016	0.031
θ	0°	6°	0°	6°

TSSOP-14

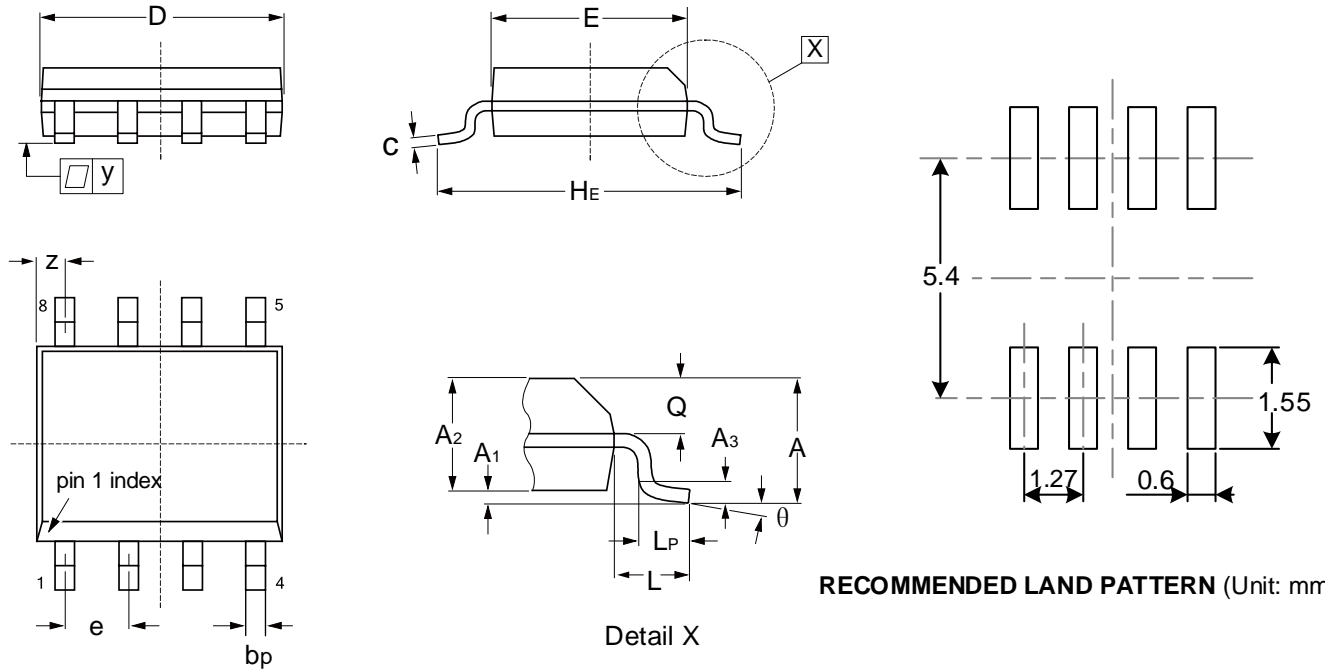
Detail X

RECOMMENDED LAND PATTERN (Unit: mm)

Symbol	Dimensions In Millimeters		Dimensions In Inches	
	Min	Max	Min	Max
A		1.100		0.043
A ₁	0.050	0.150	0.002	0.006
A ₂	0.800	0.950	0.031	0.037
A ₃	0.25		0.010	
b _p	0.190	0.300	0.007	0.012
c	0.100	0.200	0.004	0.008
D ^(A)	4.900	5.100	0.193	0.201
E ^(B)	4.300	4.500	0.169	0.177
H _E	6.200	6.600	0.244	0.260
e	0.650		0.026	
L	1		0.039	
L _P	0.500	0.750	0.020	0.030
Q	0.300	0.400	0.012	0.016
Z ^(A)	0.380	0.720	0.015	0.028
y	0.1		0.004	
θ	0°	8°	0°	8°

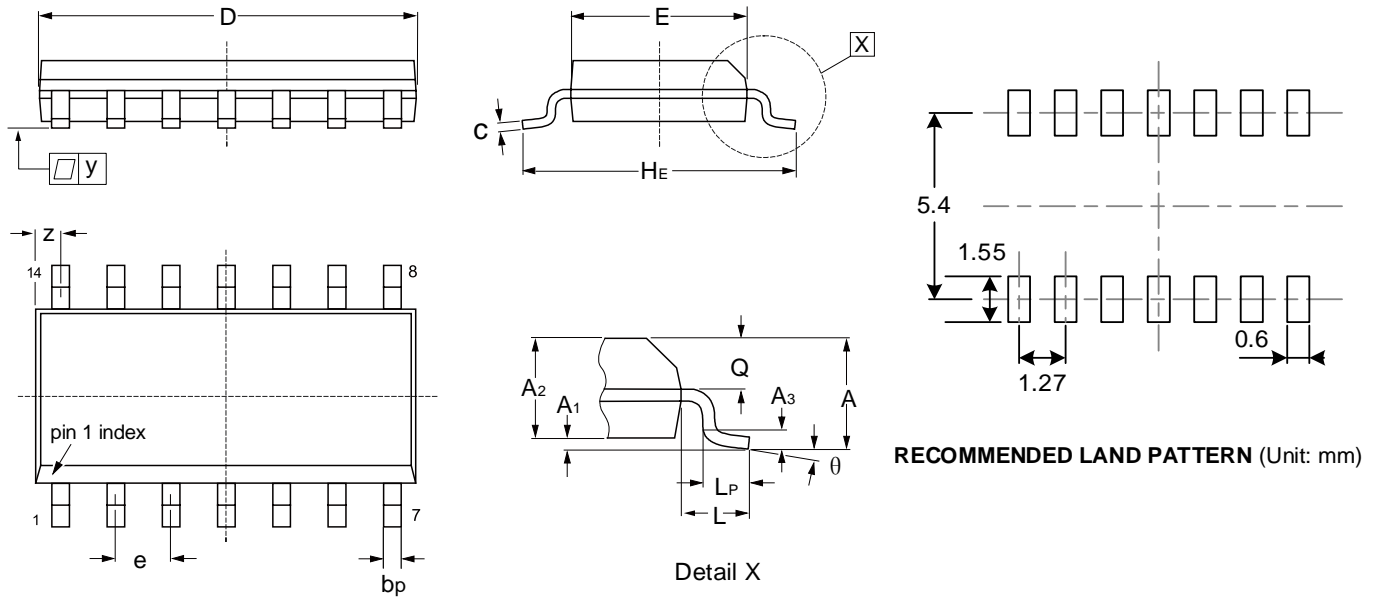
SOIC-8(SOP8)

RECOMMENDED LAND PATTERN (Unit: mm)

Symbol	Dimensions In Millimeters		Dimensions In Inches	
	Min	Max	Min	Max
A		1.750		0.069
A ₁	0.100	0.250	0.004	0.010
A ₂	1.250	1.450	0.049	0.057
A ₃	0.25		0.010	
b _p	0.360	0.490	0.014	0.019
c	0.190	0.250	0.007	0.010
D ^(A)	4.800	5.000	0.190	0.200
E ^(B)	3.800	4.000	0.150	0.160
H _E	5.800	6.200	0.228	0.244
e	1.270		0.050	
L	1.05		0.041	
L _P	0.400	1.000	0.016	0.039
Q	0.600	0.700	0.024	0.028
Z ^(A)	0.300	0.700	0.012	0.028
y	0.1		0.004	
θ	0°	8°	0°	8°

SOIC-14(SOP14)

Symbol	Dimensions In Millimeters		Dimensions In Inches	
	Min	Max	Min	Max
A		1.750		0.069
A ₁	0.100	0.250	0.004	0.010
A ₂	1.250	1.450	0.049	0.057
A ₃	0.25		0.010	
b _p	0.360	0.490	0.014	0.019
c	0.190	0.250	0.007	0.010
D ^(A)	8.550	8.750	0.340	0.350
E ^(A)	3.800	4.000	0.150	0.160
H _E	5.800	6.200	0.228	0.244
e	1.270		0.050	
L	1.05		0.041	
L _P	0.400	1.000	0.016	0.039
Q	0.600	0.700	0.024	0.028
Z ^(A)	0.300	0.700	0.012	0.028
y	0.1		0.004	
θ	0°	8°	0°	8°

NOTE:

- A. Plastic or metal protrusions of 0.15mm maximum per side are not included.
- B. Plastic interlead protrusions of 0.25mm maximum per side are not included.
- C. All linear dimension is in millimeters.
- D. This drawing is subject to change without notice.
- E. Body dimensions do not include mold flash or protrusion. Mold flash and protrusion shall not exceed 0.15 per side.
- F. BSC: Basic Dimension. Theoretically exact value shown without tolerances.

12 TAPE AND REEL INFORMATION

REEL DIMENSIONS

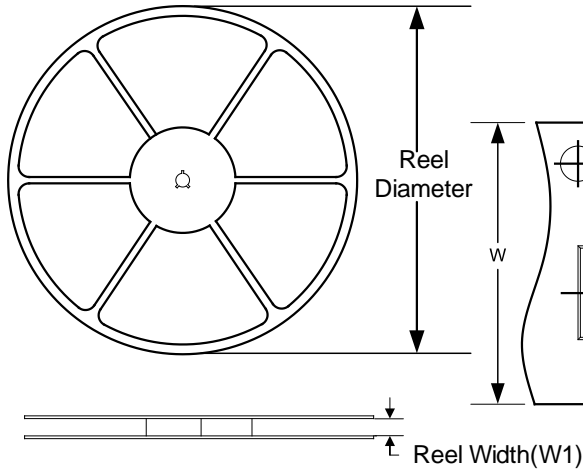

TAPE DIMENSION

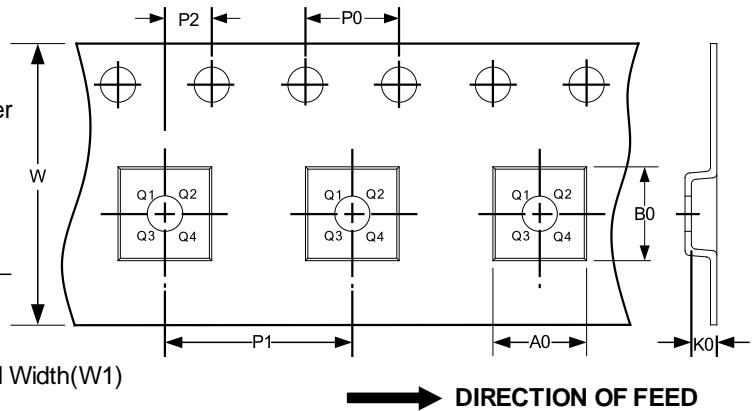

NOTE: The picture is only for reference. Please make the object as the standard.

KEY PARAMETER LIST OF TAPE AND REEL

Package Type	Reel Diameter	Reel Width(mm)	A0 (mm)	B0 (mm)	K0 (mm)	P0 (mm)	P1 (mm)	P2 (mm)	W (mm)	Pin1 Quadrant
SOT23-5	7"	9.5	3.20	3.20	1.40	4.0	4.0	2.0	8.0	Q3
SOIC-8(SOP8)	13"	12.4	6.40	5.40	2.10	4.0	8.0	2.0	12.0	Q1
MSOP-8	13"	12.4	5.20	3.30	1.50	4.0	8.0	2.0	12.0	Q1
SOIC-14(SOP14)	13"	16.4	6.60	9.30	2.10	4.0	8.0	2.0	16.0	Q1
TSSOP-14	13"	12.4	6.95	5.60	1.20	4.0	8.0	2.0	12.0	Q1

NOTE:

1. All dimensions are nominal.
2. Plastic or metal protrusions of 0.15mm maximum per side are not included.

IMPORTANT NOTICE AND DISCLAIMER

Jiangsu Runic Technology Co., Ltd. will accurately and reliably provide technical and reliability data (including data sheets), design resources (including reference designs), application or other design advice, WEB tools, safety information and other resources, without warranty of any defect, and will not make any express or implied warranty, including but not limited to the warranty of merchantability. Implied warranty that it is suitable for a specific purpose or does not infringe the intellectual property rights of any third party.

These resources are intended for skilled developers designing with Runic products. You will be solely responsible for: (1) Selecting the appropriate products for your application; (2) Designing, validating and testing your application; (3) Ensuring your application meets applicable standards and any other safety, security or other requirements; (4) Runic and the Runic logo are registered trademarks of Runic Incorporated. All trademarks are the property of their respective owners; (5) For change details, review the revision history included in any revised document. The resources are subject to change without notice. Our company will not be liable for the use of this product and the infringement of patents or third-party intellectual property rights due to its use.

X-ON Electronics

Largest Supplier of Electrical and Electronic Components

Click to view similar products for [Analog Comparators](#) category:

Click to view products by [RUNIC](#) manufacturer:

Other Similar products are found below :

[SC2903VDR2G](#) [LM2901SNG](#) [LM339SNG](#) [55122](#) [5962-8757203IA](#) [NTE911](#) [LM339EDR2G](#) [NTE922](#) [UPC177GR-9LG-E2-A](#)
[HT393VRMZ](#) [LM2903YD](#) [NCV2200SN1T1G](#) [LM2903A-SR](#) [LM339A-SR](#) [HT339ARQZ](#) [LM2901XP](#) [LM2903DR-JSM](#) [MS8923](#)
[LM239AM/TR](#) [LM393LVQDGKRQ1](#) [LM393LVQPWRQ1](#) [LM2903BWDSGRQ1](#) [TLV3801DSGT](#) [LM331BXF](#) [AD790JRZ-REEL](#)
[LM339A-TR](#) [LT6700HVHS6-1#TRPBF](#) [GS2903-SR](#) [LMV7219M5/TR](#) [LMV7239M5/TR](#) [LM293ADR-HXY](#) [LM293DR-HXY](#) [LM339N-](#)
[HXY](#) [LM393P-HXY](#) [IL339DT](#) [LM2901XQ](#) [RS331XF-Q1](#) [MIC842NYMT-TR](#) [LM393FVM-TR](#) [LM393P](#) [TLV3602QDGKRQ1](#)
[TLV7032QDGKRQ1](#) [TLV3601QDBVRQ1](#) [LM2901BQPWRQ1](#) [TLV3603DCKR](#) [TLV3603DCKT](#) [AiP74HC85TA16.TB](#)
[LMV331IDBVR\(MS\)](#) [LMV331W5-7\(MS\)](#) [MCP6561UT-E\(MS\)](#)